

Notice for TAIYO YUDEN products

Please read this notice before using the TAIYO YUDEN products.

⚠️ REMINDERS

■ Product Information in this Catalog

Product information in this catalog is as of October 2019. All of the contents specified herein and production status of the products listed in this catalog are subject to change without notice due to technical improvement of our products, etc. Therefore, please check for the latest information carefully before practical application or use of our products.

Please note that TAIYO YUDEN shall not be in any way responsible for any damages and defects in products or equipment incorporating our products, which are caused under the conditions other than those specified in this catalog or individual product specification sheets.

■ Approval of Product Specifications

Please contact TAIYO YUDEN for further details of product specifications as the individual product specification sheets are available. When using our products, please be sure to approve our product specifications or make a written agreement on the product specification with TAIYO YUDEN in advance.

■ Pre-Evaluation in the Actual Equipment and Conditions

Please conduct validation and verification of our products in actual conditions of mounting and operating environment before using our products.

■ Limited Application

1. Equipment Intended for Use

The products listed in this catalog are intended for general-purpose and standard use in general electronic equipment (e.g., AV equipment, OA equipment, home electric appliances, office equipment, information and communication equipment including, without limitation, mobile phone, and PC) and other equipment specified in this catalog or the individual product specification sheets.

TAIYO YUDEN has the line-up of the products intended for use in automotive electronic equipment, telecommunications infrastructure and industrial equipment, or medical devices classified as GHTF Classes A to C (Japan Classes I to III). Therefore, when using our products for these equipment, please check available applications specified in this catalog or the individual product specification sheets and use the corresponding products.

2. Equipment Requiring Inquiry

Please be sure to contact TAIYO YUDEN for further information before using the products listed in this catalog for the following equipment (excluding intended equipment as specified in this catalog or the individual product specification sheets) which may cause loss of human life, bodily injury, serious property damage and/or serious public impact due to a failure or defect of the products and/or malfunction attributed thereto.

- (1) Transportation equipment (automotive powertrain control system, train control system, and ship control system, etc.)
- (2) Traffic signal equipment
- (3) Disaster prevention equipment, crime prevention equipment
- (4) Medical devices classified as GHTF Class C (Japan Class III)
- (5) Highly public information network equipment, data-processing equipment (telephone exchange, and base station, etc.)
- (6) Any other equipment requiring high levels of quality and/or reliability equal to the equipment listed above

3. Equipment Prohibited for Use

Please do not incorporate our products into the following equipment requiring extremely high levels of safety and/or reliability.

- (1) Aerospace equipment (artificial satellite, rocket, etc.)
- (2) Aviation equipment *¹
- (3) Medical devices classified as GHTF Class D (Japan Class IV), implantable medical devices *²

- (4) Power generation control equipment (nuclear power, hydroelectric power, thermal power plant control system, etc.)
- (5) Undersea equipment (submarine repeating equipment, underwater work equipment, etc.)
- (6) Military equipment
- (7) Any other equipment requiring extremely high levels of safety and/or reliability equal to the equipment listed above

*Notes:

1. There is a possibility that our products can be used only for aviation equipment that does not directly affect the safe operation of aircraft (e.g., in-flight entertainment, cabin light, electric seat, cooking equipment) if such use meets requirements specified separately by TAIYO YUDEN. Please be sure to contact TAIYO YUDEN for further information before using our products for such aviation equipment.
2. Implantable medical devices contain not only internal unit which is implanted in a body, but also external unit which is connected to the internal unit.

4. Limitation of Liability

Please note that unless you obtain prior written consent of TAIYO YUDEN, TAIYO YUDEN shall not be in any way responsible for any damages incurred by you or third parties arising from use of the products listed in this catalog for any equipment that is not intended for use by TAIYO YUDEN, or any equipment requiring inquiry to TAIYO YUDEN or prohibited for use by TAIYO YUDEN as described above.

■ Safety Design

When using our products for high safety and/or reliability-required equipment or circuits, please fully perform safety and/or reliability evaluation. In addition, please install (i) systems equipped with a protection circuit and a protection device and/or (ii) systems equipped with a redundant circuit or other system to prevent an unsafe status in the event of a single fault for a failsafe design to ensure safety.

■ Intellectual Property Rights

Information contained in this catalog is intended to convey examples of typical performances and/or applications of our products and is not intended to make any warranty with respect to the intellectual property rights or any other related rights of TAIYO YUDEN or any third parties nor grant any license under such rights.

■ Limited Warranty

Please note that the scope of warranty for our products is limited to the delivered our products themselves and TAIYO YUDEN shall not be in any way responsible for any damages resulting from a failure or defect in our products. Notwithstanding the foregoing, if there is a written agreement (e.g., supply and purchase agreement, quality assurance agreement) signed by TAIYO YUDEN and your company, TAIYO YUDEN will warrant our products in accordance with such agreement.

■ TAIYO YUDEN's Official Sales Channel

The contents of this catalog are applicable to our products which are purchased from our sales offices or authorized distributors (hereinafter "TAIYO YUDEN's official sales channel"). Please note that the contents of this catalog are not applicable to our products purchased from any seller other than TAIYO YUDEN's official sales channel.

■ Caution for Export

Some of our products listed in this catalog may require specific procedures for export according to "U.S. Export Administration Regulations", "Foreign Exchange and Foreign Trade Control Law" of Japan, and other applicable regulations. Should you have any questions on this matter, please contact our sales staff.



REFLOW

■ PARTS NUMBER

(A) Previous Rule (applied products registered on March 31, 2010 or before.)

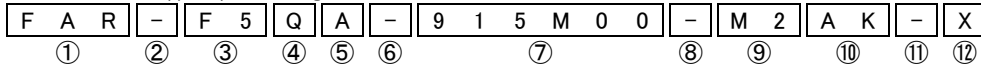

- | <p>① Family</p> <p>② Common sign</p> <p>③ Series name</p> <table border="1" style="width: 100%; border-collapse: collapse; text-align: center;"> <thead> <tr style="background-color: #f2f2f2;"> <th>Code</th><th>Product</th><th>Frequency Range [MHz]</th></tr> </thead> <tbody> <tr><td>D5</td><td>Duplexer</td><td>700 - 1000</td></tr> <tr><td>D6</td><td>Duplexer</td><td>1000 - 5000</td></tr> <tr><td>J5</td><td>Triplexer</td><td>700 - 1000</td></tr> <tr><td>F5</td><td>Device</td><td>700 - 1000</td></tr> <tr><td>F6</td><td>Device</td><td>1000 - 5000</td></tr> <tr><td>G5</td><td>Dual Devices</td><td>700 - 1000</td></tr> <tr><td>G6</td><td>Dual Devices</td><td>1000 - 5000</td></tr> </tbody> </table> | Code | Product | Frequency Range [MHz] | D5 | Duplexer | 700 - 1000 | D6 | Duplexer | 1000 - 5000 | J5 | Triplexer | 700 - 1000 | F5 | Device | 700 - 1000 | F6 | Device | 1000 - 5000 | G5 | Dual Devices | 700 - 1000 | G6 | Dual Devices | 1000 - 5000 | <p>④ Package code</p> <p>⑤ Product code</p> <p>⑥ Common sign</p> <p>⑦ Frequency</p> <p>⑧ Common sign</p> <p>⑨ Internal code</p> <p>⑩ Internal code</p> <p>⑪ Custom code</p> <p>⑫ Packaging</p> |
|-----------------------------------------------------------------------------------------------------------------------------------------------------------------------------------------------------------------------------------------------------------------------------------------------------------------------------------------------------------------------------------------------------------------------------------------------------------------------------------------------------------------------------------------------------------------------------------------------------------------------------------------------------------------------------------------------------------------------------|--------------|-----------------------|-----------------------|----|----------|------------|----|----------|-------------|----|-----------|------------|----|--------|------------|----|--------|-------------|----|--------------|------------|----|--------------|-------------|------------------------------------------------------------------------------------------------------------------------------------------------------------------------------------------------|
| Code | Product | Frequency Range [MHz] | | | | | | | | | | | | | | | | | | | | | | | |
| D5 | Duplexer | 700 - 1000 | | | | | | | | | | | | | | | | | | | | | | | |
| D6 | Duplexer | 1000 - 5000 | | | | | | | | | | | | | | | | | | | | | | | |
| J5 | Triplexer | 700 - 1000 | | | | | | | | | | | | | | | | | | | | | | | |
| F5 | Device | 700 - 1000 | | | | | | | | | | | | | | | | | | | | | | | |
| F6 | Device | 1000 - 5000 | | | | | | | | | | | | | | | | | | | | | | | |
| G5 | Dual Devices | 700 - 1000 | | | | | | | | | | | | | | | | | | | | | | | |
| G6 | Dual Devices | 1000 - 5000 | | | | | | | | | | | | | | | | | | | | | | | |

(B) New Rule (applied to products registered on April 1, 2010 or later.)

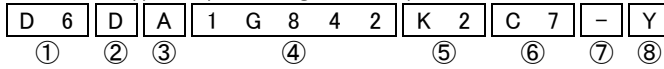

- | <p>① Series name</p> <table border="1" style="width: 100%; border-collapse: collapse; text-align: center;"> <thead> <tr style="background-color: #f2f2f2;"> <th>Code</th><th>Product</th><th>Frequency Range [MHz]</th></tr> </thead> <tbody> <tr><td>D5</td><td>Duplexer</td><td>700 - 1000</td></tr> <tr><td>D6</td><td>Duplexer</td><td>1000 - 5000</td></tr> <tr><td>J5</td><td>Triplexer</td><td>700 - 1000</td></tr> <tr><td>F5</td><td>Device</td><td>700 - 1000</td></tr> <tr><td>F6</td><td>Device</td><td>1000 - 5000</td></tr> <tr><td>G5</td><td>Dual Devices</td><td>700 - 1000</td></tr> <tr><td>G6</td><td>Dual Devices</td><td>1000 - 5000</td></tr> <tr><td>H6</td><td>Triple Devices</td><td>1000 - 5000</td></tr> <tr><td>K6</td><td>Quadplexer</td><td>1000 - 5000</td></tr> </tbody> </table> | Code | Product | Frequency Range [MHz] | D5 | Duplexer | 700 - 1000 | D6 | Duplexer | 1000 - 5000 | J5 | Triplexer | 700 - 1000 | F5 | Device | 700 - 1000 | F6 | Device | 1000 - 5000 | G5 | Dual Devices | 700 - 1000 | G6 | Dual Devices | 1000 - 5000 | H6 | Triple Devices | 1000 - 5000 | K6 | Quadplexer | 1000 - 5000 | <p>② Package code</p> <p>③ Product code</p> <p>④ Frequency</p> <p>⑤ Internal code</p> <p>⑥ Internal code</p> <p>⑦ Custom code</p> <p>⑧ Packaging</p> |
|--------------------------------------------------------------------------------------------------------------------------------------------------------------------------------------------------------------------------------------------------------------------------------------------------------------------------------------------------------------------------------------------------------------------------------------------------------------------------------------------------------------------------------------------------------------------------------------------------------------------------------------------------------------------------------------------------------------------------------------------------------------------------------------------------------------------|----------------|-----------------------|-----------------------|----|----------|------------|----|----------|-------------|----|-----------|------------|----|--------|------------|----|--------|-------------|----|--------------|------------|----|--------------|-------------|----|----------------|-------------|----|------------|-------------|------------------------------------------------------------------------------------------------------------------------------------------------------|
| Code | Product | Frequency Range [MHz] | | | | | | | | | | | | | | | | | | | | | | | | | | | | | |
| D5 | Duplexer | 700 - 1000 | | | | | | | | | | | | | | | | | | | | | | | | | | | | | |
| D6 | Duplexer | 1000 - 5000 | | | | | | | | | | | | | | | | | | | | | | | | | | | | | |
| J5 | Triplexer | 700 - 1000 | | | | | | | | | | | | | | | | | | | | | | | | | | | | | |
| F5 | Device | 700 - 1000 | | | | | | | | | | | | | | | | | | | | | | | | | | | | | |
| F6 | Device | 1000 - 5000 | | | | | | | | | | | | | | | | | | | | | | | | | | | | | |
| G5 | Dual Devices | 700 - 1000 | | | | | | | | | | | | | | | | | | | | | | | | | | | | | |
| G6 | Dual Devices | 1000 - 5000 | | | | | | | | | | | | | | | | | | | | | | | | | | | | | |
| H6 | Triple Devices | 1000 - 5000 | | | | | | | | | | | | | | | | | | | | | | | | | | | | | |
| K6 | Quadplexer | 1000 - 5000 | | | | | | | | | | | | | | | | | | | | | | | | | | | | | |

*For further details, please contact to TAIYO YUDEN CO., LTD.

■ EXTERNAL DIMENSIONS

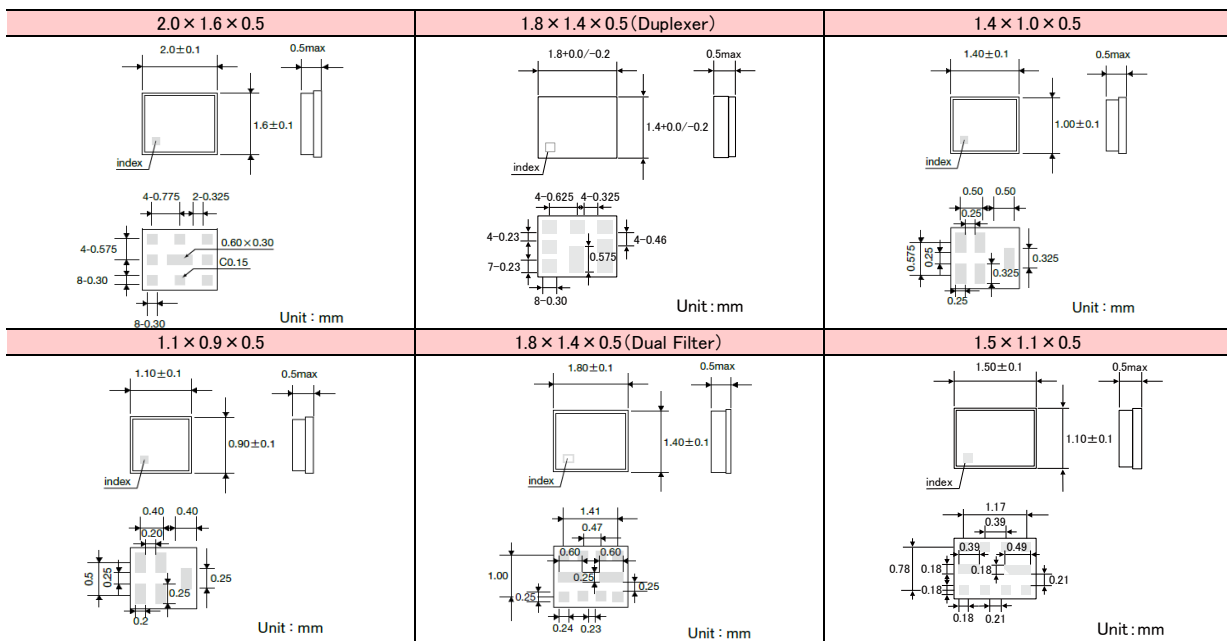

▶ This catalog contains the typical specification only due to the limitation of space. When you consider the purchase of our products, please check our product specification sheets. For details of each product (characteristics graph, reliability information, precautions for use, and so on), see our website (<http://www.ty-top.com/>).

■ PARTS NUMBER

● Duplexers

| System | Part number | Package Size [mm] | Insertion Loss [dB] | Attenuation [dB] | Remarks | |
|---------------|----------------|-----------------------|----------------------|------------------|---------------------------------------------|---------|
| Band 1 | D6DA2G140K2A4 | 1.8 × 1.4 × 0.5 max. | 1.8/1.8 | 56/51 | | |
| | D6DA2G140K2A7 | 1.8 × 1.4 × 0.5 max. | 1.6/1.7 | 58/59 | | |
| | D6PE2G140P3AW | 2.0 × 1.6 × 0.5 max. | 1.5/1.6 | 59/47 | Rx : Bal.100ohm | |
| | D6RB2G140E1AJ | 1.8 × 1.4 × 0.5 max. | 1.7/1.8 | 57/48 | Rx : Bal.100ohm | |
| | D6RB2G140E1AL | 1.8 × 1.4 × 0.47 max. | 1.7/1.8 | 57/51 | Rx : Bal.100ohm | |
| Band 2 | D6PF1G960M3B6 | 2.0 × 1.6 × 0.57 max. | 2.2/2.7 | 55/52 | | |
| | D6PF1G960M3B9 | 2.0 × 1.6 × 0.57 max. | 2.2/2.7 | 57/52 | | |
| | D6DA1G960K2B1 | 1.8 × 1.4 × 0.57 max. | 1.9/2.5 | 54/54 | | |
| | D6DA1G960K2B2 | 1.8 × 1.4 × 0.57 max. | 1.8/2.3 | 55/55 | | |
| | D6PE1G960P3BY | 2.0 × 1.6 × 0.57 max. | 2.0/3.1 | 57/53 | Rx : Bal.100ohm | |
| | D6PE1G960P3BP | 2.0 × 1.6 × 0.57 max. | 2.3/3.0 | 56/52 | Rx : Bal.100ohm | |
| Band 3 | D6RB1G960E1HB | 1.8 × 1.4 × 0.6 max. | 2.1/2.9 | 56/55 | Rx : Bal.100ohm | |
| | D6DA1G842K2C4 | 1.8 × 1.4 × 0.6 max. | 2.3/2.1 | 56/56 | | |
| Band 4 | D6DA1G842K2C7 | 1.8 × 1.4 × 0.38 max. | 1.8/1.9 | 60/56 | | |
| | D6DA2G132K2D4 | 1.8 × 1.4 × 0.5 max. | 1.5/1.7 | 57/55 | | |
| Band 5 | D6DA2G132K2D9 | 1.8 × 1.4 × 0.5 max. | 1.6/1.8 | 60/56 | | |
| | D6PE2G132P3DWB | 2.0 × 1.6 × 0.5 max. | 1.8/1.8 | 55/50 | Rx : Bal.100ohm | |
| | D6RB2G132E1DF | 1.8 × 1.4 × 0.5 max. | 1.6/1.8 | 62/54 | Rx : Bal.100ohm | |
| | D5DA881M5K2E4 | 1.8 × 1.4 × 0.5 max. | 1.4/1.7 | 58/59 | | |
| Band 7 | D5RB881M5E1BH | 1.8 × 1.4 × 0.47 max. | 1.4/1.7 | 58/52 | Rx : Bal.100ohm | |
| | D6HL2G655DL06 | 2.0 × 1.6 × 0.54 max. | 2.1/2.3 | 53/57 | FBAR | |
| | D6HQ2G655DP01 | 1.8 × 1.4 × 0.54 max. | 2.3/2.2 | 58/57 | FBAR | |
| | D6HQ2G655DP02 | 1.8 × 1.4 × 0.54 max. | 2.0/2.0 | 58/55 | FBAR 2HD Improved | |
| | D6HQ2G655DP03 | 1.8 × 1.4 × 0.54 max. | 2.0/2.0 | 61/56 | | |
| | D6DA2G655K2F1 | 1.8 × 1.4 × 0.44 max. | 2.1/2.2 | 50/50 | | |
| | D6HN2G655BN54 | 2.0 × 1.6 × 0.54 max. | 1.8/2.6 | 55/56 | Rx : Bal.100ohm, FBAR WLAN coexistence Ver. | |
| | D6HP2G655BP11 | 1.8 × 1.4 × 0.54 max. | 1.8/2.4 | 56/56 | Rx : Bal.100ohm, FBAR | |
| | Band 8 | D5PF942M5M3G6 | 2.0 × 1.6 × 0.5 max. | 2.1/2.1 | 57/55 | for LTE |
| | | D5PF942M5M3G9 | 2.0 × 1.6 × 0.5 max. | 1.9/2.2 | 60/52 | |
| D5DA942M5K2G6 | | 1.8 × 1.4 × 0.5 max. | 1.7/1.8 | 58/59 | | |
| D5DA942M5K2S2 | | 1.8 × 1.4 × 0.6 max. | 1.3/1.5 | 58/56 | for LTE | |
| D5PE942M5P3GT | | 2.0 × 1.6 × 0.5 max. | 1.8/2.2 | 60/55 | Rx : Bal.100ohm | |
| Band 11 | D5RB942M5E1CF | 1.8 × 1.4 × 0.5 max. | 1.5/1.9 | 56/51 | Rx : Bal.100ohm | |
| | D6DA1G485K2W1 | 1.8 × 1.4 × 0.44 max. | 1.2/1.3 | 58/60 | | |
| Band 12 | D5DA737M5K2H2 | 1.8 × 1.4 × 0.5 max. | 1.65/1.65 | 63/58 | | |
| Band 13 | D5PE782M0M3P9 | 2.0 × 1.6 × 0.5 max. | 1.6/2.0 | 64/55 | | |
| | D5DA782M0K2J6 | 1.8 × 1.4 × 0.5 max. | 1.9/1.7 | 58/61 | | |
| Band 14 | D5DA793M0K2K2 | 1.8 × 1.4 × 0.44 max. | 1.2/2.2 | 50/50 | | |
| Band 17 | D5PF740M0M3R9 | 2.0 × 1.6 × 0.5 max. | 1.6/1.8 | 61/66 | | |
| | D5DA740M0K2L4 | 1.8 × 1.4 × 0.5 max. | 1.25/1.65 | 65/60 | | |
| Band 20 | D5FC847M0K3NE | 1.8 × 1.4 × 0.44 max. | 1.8/1.8 | 55/56 | | |
| Band 21 | D6DA1G503K2Y1 | 1.8 × 1.4 × 0.44 max. | 1.3/1.3 | 60/60 | | |
| | D6PE1G503P3KW | 2.0 × 1.6 × 0.5 max. | 1.6/2.0 | 55/56 | Rx : Bal.100ohm | |
| Band 25 | D6HQ1G962DP35 | 1.8 × 1.4 × 0.57 max. | 2.5/2.6 | 57/57 | FBAR | |
| Band 26 | D5PF876M5M3U9 | 2.0 × 1.6 × 0.5 max. | 2.0/1.9 | 56/49 | | |
| | D5DA876M5K2P6 | 1.8 × 1.4 × 0.6 max. | 1.3/2.0 | 60/57 | | |
| | D5PE876M5P3UZ | 2.0 × 1.6 × 0.5 max. | 2.2/2.6 | 60/49 | Rx : Bal.100ohm | |
| Band 28 | D5PF773M0M3Y6 | 2.0 × 1.6 × 0.5 max. | 1.8/2.3 | 60/53 | Block A | |
| | D5FC773M0K3NC | 1.8 × 1.4 × 0.44 max. | 2.5/2.6 | 57/57 | | |
| | D5PF788M0M3Y9 | 2.0 × 1.6 × 0.5 max. | 1.8/2.4 | 60/54 | Block B | |
| | D5FC788M0K3ND | 1.8 × 1.4 × 0.44 max. | 1.8/1.9 | 63/60 | | |
| Band 66 | D6DA2G155K2T2 | 1.8 × 1.4 × 0.44 max. | 2.0/2.0 | 57/54 | | |

● Multiplexers

| System | Part number | Package Size [mm] | Insertion Loss [dB] | Attenuation [dB] | Remarks |
|----------------------|---------------|----------------------|---------------------|------------------|---------|
| Band 13+17 Triplexer | J5NA782M0P1H6 | 2.5 × 2.0 × 0.6 max. | 1.6/1.9 | 60/49 | |
| | | | 1.9/1.9 | 53/55 | |
| Band 1+3 Quadplexer | K6QZ2G140Q3ZA | 2.5 × 2.0 × 0.8 max. | 1.9/2.0 | 56/55 | |
| | | | 1.7/2.3 | 56/54 | |
| | K6QZ2G140Q3ZC | 2.5 × 2.0 × 0.8 max. | 2.0/1.9 | 55/57 | |
| | | | 2.4/2.3 | 57/58 | |

▶ This catalog contains the typical specification only due to the limitation of space. When you consider the purchase of our products, please check our product specification sheets. For details of each product (characteristics graph, reliability information, precautions for use, and so on), see our website (<http://www.ty-top.com/>).

HIGH FREQUENCY PRODUCTS

■ PARTS NUMBER

● W-CDMA / LTE / CDMA 2000 Filters

| System | Part number | Package Size [mm] | Insertion Loss [dB] | Attenuation [dB] | Remarks |
|------------------------|---------------|-----------------------|---------------------|------------------|-----------------------|
| Band 1 Tx | F6QA1G950M2AA | 1.1 × 0.9 × 0.5 max. | 1.8 | 38 | |
| Band 1, Band 4 Rx | F6QA2G140M2AM | 1.1 × 0.9 × 0.5 max. | 1.9 | 46 | |
| | F6QG2G140P2KA | 1.1 × 0.9 × 0.5 max. | 1.7 | 55 | 100ohm output |
| Band 2 Tx BC1 (PCS) Tx | F6QA1G880M2AQ | 1.1 × 0.9 × 0.5 max. | 1.7 | 20 | |
| Band 2 Rx BC1 (PCS) Rx | F6QA1G960M2AP | 1.1 × 0.9 × 0.5 max. | 2.8 | 39 | High Att. |
| | F6QG1G960P2KT | 1.1 × 0.9 × 0.5 max. | 2.8 | 44 | 100ohm output |
| Band 3 Tx | F6QA1G747M2QS | 1.1 × 0.9 × 0.5 max. | 2.1 | 22 | |
| Band 3 Rx | F6QA1G842M2AN | 1.1 × 0.9 × 0.5 max. | 2.0 | 38 | |
| | F6QG1G842P2KD | 1.1 × 0.9 × 0.5 max. | 3.2 | 45 | 100ohm output |
| Band 5 Tx BC0 Tx | F5QA836M5M2AR | 1.1 × 0.9 × 0.5 max. | 1.9 | 45 | High Att. |
| Band 5 Rx BC0 Rx | F5QA881M5M2AU | 1.1 × 0.9 × 0.5 max. | 1.3 | 51 | Low Loss/high Att. |
| | F5QG881M5P2KG | 1.1 × 0.9 × 0.5 max. | 1.5 | 56 | 100ohm output |
| Band 7 Rx | F6QA2G655M2QH | 1.1 × 0.9 × 0.5 max. | 2.5 | 38 | |
| | F6QG2G655P2KE | 1.1 × 0.9 × 0.5 max. | 2.5 | 52 | 100ohm. High Att. |
| Band 8 Tx | F5QA897M5M2AC | 1.1 × 0.9 × 0.5 max. | 2.3 | 18 | |
| Band 8 Rx | F5QA942M5M2AW | 1.1 × 0.9 × 0.5 max. | 2.0 | 48 | for LTE |
| | F5QG942M5P2KB | 1.1 × 0.9 × 0.5 max. | 2.2 | 56 | 100ohm output |
| | F5QG942M5P2KF | 1.1 × 0.9 × 0.5 max. | 2.2 | 60 | 100ohm output for LTE |
| Band 12 Rx | F5QA737M5M2QN | 1.1 × 0.9 × 0.5 max. | 1.6 | 53 | |
| | F5QG737M5P2KK | 1.1 × 0.9 × 0.5 max. | 1.6 | 55 | 100ohm output |
| Band 13 Tx | F5QA782M0M2AZ | 1.1 × 0.9 × 0.5 max. | 1.5 | 56 | |
| Band 13 Rx | F5QA751M0M2QM | 1.1 × 0.9 × 0.5 max. | 1.9 | 50 | |
| Band 14 | F5QA763M0M2QL | 1.1 × 0.9 × 0.5 max. | 2.2 | 49 | |
| Band 17 Tx | F5QA710M0M2AY | 1.1 × 0.9 × 0.5 max. | 1.3 | 33 | |
| Band 17 Rx | F5QG740M0P2KH | 1.1 × 0.9 × 0.5 max. | 1.4 | 65 | 100ohm output |
| Band 20 Rx | F5QA806M0M2QE | 1.1 × 0.9 × 0.5 max. | 2.7 | 41 | |
| Band 21 Rx | F6QA1G503M2QF | 1.1 × 0.9 × 0.5 max. | 2.0 | 52 | |
| Band 25 Tx | F6QA1G882M2AS | 1.1 × 0.9 × 0.5 max. | 1.8 | 23 | |
| Band 26 Rx | F5QA876M5M2QP | 1.1 × 0.9 × 0.5 max. | 2.2 | 49 | |
| | F5QG876M5P2KQ | 1.1 × 0.9 × 0.5 max. | 2.2 | 59 | 100ohm output |
| Band 28 Rx | F5QA773M0M2QC | 1.1 × 0.9 × 0.5 max. | 2.1 | 52 | Block A |
| | F5QA788M0M2QB | 1.1 × 0.9 × 0.5 max. | 2.0 | 52 | Block B |
| Band 29 Rx | F5BA722M5M6UW | 1.1 × 0.9 × 0.44 max. | 1.6 | - | |
| Band 30 Rx | F6QP2G355R2SE | 1.1 × 0.9 × 0.5 max. | 2.1 | 50 | |
| Band 32 Rx | F6QA1G474H2JS | 1.1 × 0.9 × 0.5 max. | 1.8 | - | |
| Band 66 Rx | F6BA2G155M6UU | 1.1 × 0.9 × 0.44 max. | 1.7 | 45 | |
| Band 67 Rx | F5QA748M0M2WF | 1.1 × 0.9 × 0.5 max. | 1.5 | - | |

● W-CDMA / LTE Dual Filters

| System | Part number | Package Size [mm] | Insertion Loss [dB] | Attenuation [dB] | Remarks |
|----------------------------|---------------|----------------------|---------------------|------------------|--------------|
| Band 3+1 Rx (Common Input) | G6QN2G140M2RN | 1.5 × 1.1 × 0.5 max. | 2.0/1.7 | 40/52 | For B1+B3 CA |

● TDD Filters (TD-SCDMA / TD-LTE)

| System | Part number | Package Size [mm] | Insertion Loss [dB] | Attenuation [dB] | Remarks |
|-------------|---------------|-----------------------|---------------------|------------------|---------------------------------------------------------------------------|
| Band 34 TRx | F6FC2G017H4PC | 1.1 × 0.9 × 0.44 max. | 1.1 | - | Input Power +29dBm (TDD:50% Duty) |
| Band 34 Rx | F6QP2G017R2SF | 1.1 × 0.9 × 0.5 max. | 1.3 | - | |
| Band 38 Tx | F6KA2G595A4VL | 1.4 × 1.0 × 0.5 max. | 1.5 | - | Input Power +29dBm |
| Band 38 Rx | F6QA2G595M2QK | 1.1 × 0.9 × 0.5 max. | 1.9 | - | |
| | F6QB2G595P2BS | 1.1 × 0.9 × 0.5 max. | 2.0 | - | Balanced 100ohm |
| Band 39 TRx | F6FC1G900H4PB | 1.1 × 0.9 × 0.44 max. | 1.1 | - | Input power +29dBm (Duty 50%) |
| Band 39 Rx | F6QA1G900M2WD | 1.1 × 0.9 × 0.5 max. | 1.5 | - | |
| Band 40 Tx | F6HH2G350EH75 | 1.1 × 0.9 × 0.44 max. | 1.4 | - | Input power +30.0dBm TD-LTE 40% duty 5MHz 1RB FBAR |
| Band 40 Rx | F6QA2G350M2QA | 1.1 × 0.9 × 0.5 max. | 2.2 | - | |
| | F6QB2G350P2BH | 1.1 × 0.9 × 0.5 max. | 2.8 | - | Balanced 100ohm |
| Band 41 TRx | F6KA2G605A4LA | 1.4 × 1.0 × 0.5 max. | 2.4 | - | Unbal High power design 2555-2655MHz BW100MHz |
| | F6FC2G600H4PA | 1.1 × 0.9 × 0.44 max. | 2.1 | - | Unbal High power design & HPUE for CMCC 2535-2655MHz BW120MHz |
| | F6FC2G595H4PD | 1.1 × 0.9 × 0.44 max. | 1.7 | - | Unbal Improved IL High power design & HPUE for CMCC 2535-2655MHz BW120MHz |
| | F6HP2G593AP20 | 2.0 × 1.6 × 0.6 max. | 2.9 | - | Unbal High power design 2496-2690MHz BW194MHz FBAR |
| | F6HQ2G593AP31 | 1.8 × 1.4 × 0.57 max. | 2.7 | - | Unbal High power design & HPUE for Sprint 2496-2690MHz BW194MHz FBAR |

● TDD Dual Filters (TD-SCDMA / TD-LTE)

| System | Part number | Package Size [mm] | Insertion Loss [dB] | Attenuation [dB] | Remarks |
|-----------------------------------------------|---------------|-----------------------|---------------------|------------------|---------------------------------------------------------------|
| Band 34 + Band 39 TRx | G6FT2G017G2YA | 1.5 × 1.1 × 0.44 max. | 1.3/1.4 | - | 1 IN / 3 OUT |
| Band 39 + Band 34 + Band 41 (BW120MHz) DRx | H6FM2G595T2MZ | 1.8 × 1.4 × 0.44 max. | 1.3/1.4/2.7 | - | 1 IN / 3 OUT |
| Band 39 Rx + 41 (BW100MHz) TRx (Common Input) | G6KJ2G605D4AB | 1.8 × 1.4 × 0.5 max. | 2.1/2.6 | - | B41 High power design B41 (2555-2655MHz BW100MHz) for CMCC CA |
| Band 41 Rx + 39 (BW100MHz) DRx (Common Input) | G6QN2G605M2RM | 1.5 × 1.1 × 0.5 max. | 2.2/1.3 | - | |
| Band 41 (BW120MHz) Rx + 39Rx (Common Input) | G6QN2G595M2RP | 1.5 × 1.1 × 0.5 max. | 2.3/1.3 | - | |

▶ This catalog contains the typical specification only due to the limitation of space. When you consider the purchase of our products, please check our product specification sheets. For details of each product (characteristics graph, reliability information, precautions for use, and so on), see our website (<http://www.ty-top.com/>).

PARTS NUMBER

● GPS

| System | Part number | Package Size [mm] | Insertion Loss [dB] | Attenuation [dB] | Remarks |
|-----------------------------|---------------|-----------------------|---------------------|------------------|---------------------|
| GPS | F6QA1G575H2JF | 1.1 × 0.9 × 0.5 max. | 0.96 | - | Low loss, High Att. |
| GPS (GNSS) | F6QA1G585M2AT | 1.1 × 0.9 × 0.5 max. | 1.4 | - | |
| | F6QB1G585P2BQ | 1.1 × 0.9 × 0.5 max. | 1.7 | - | 100ohm output |
| GPS+GLONASS+Galileo+Compass | F6QA1G581M2QZ | 1.1 × 0.9 × 0.5 max. | 1.4 | - | |
| | F6QA1G582H2JM | 1.1 × 0.9 × 0.5 max. | 1.8 | - | Ladder High Att. |
| | F6BG1G582R6TT | 1.1 × 0.9 × 0.44 max. | 1.7 | - | 100ohm output |
| GNSS (L2+L5+B2) | F6FC1G197H4PF | 1.1 × 0.9 × 0.44 max. | 1.3 | - | |

● Others

| System | Part number | Package Size [mm] | Insertion Loss [dB] | Attenuation [dB] | Remarks |
|---------------------------|----------------------|-----------------------|---------------------|------------------|-----------------------------------------------|
| ISM900 (B.W.26MHz) | FAR-F5QA-915M00-M2AK | 1.1 × 0.9 × 0.5 max. | 1.8 | - | |
| Wireless LAN / Bluetooth® | F6KA2G436A4VE | 1.4 × 1.0 × 0.5 max. | 2.5 | - | 2400-2472MHz,+24dBm 2.5GHz High Att (for MTK) |
| | F6KA2G466A4VJ | 1.4 × 1.0 × 0.5 max. | 2.8 | - | 2432-2500MHz,+24dBm 2.3GHz High Att (for MTK) |
| | F6HG2G441EG65 | 1.1 × 0.9 × 0.5 max. | 1.3 | - | FBAR |
| | F6HG2G441EG66 | 1.1 × 0.9 × 0.5 max. | 1.3 | - | High Att. @2.38GHz FBAR |
| | F6FC2G441H4PE | 1.1 × 0.9 × 0.44 max. | 1.0 | - | SAW |

FBAR/SAW DEVICES for MOBILE COMMUNICATIONS

PACKAGING

① Minimum Quantity

| Type | Size [mm] | Code & Quantity [pcs] | | | | | |
|---------------|-----------|-----------------------|-------|--------|-------|---|------|
| | | Standard | | Option | | | |
| Duplexer | 2.0 × 1.6 | Y | 15000 | Z | 3000 | | |
| | 1.8 × 1.4 | Y | 15000 | Z | 3000 | | |
| Quadplexer | 2.5 × 2.0 | U | 10000 | Z | 3000 | | |
| Triplexer | 2.5 × 2.0 | U | 10000 | Z | 3000 | | |
| Single Filter | 2.0 × 1.6 | Y | 15000 | Z | 3000 | | |
| | 1.8 × 1.4 | Y | 15000 | Z | 3000 | | |
| | 1.4 × 1.0 | Y | 15000 | Z | 3000 | | |
| | 1.1 × 0.9 | X | 10000 | Y | 15000 | J | 5000 |
| Dual Filter | 1.8 × 1.4 | Y | 15000 | Z | 3000 | | |
| | 1.5 × 1.1 | Y | 15000 | J | 5000 | | |
| Triple Filter | 1.8 × 1.4 | Y | 15000 | Z | 3000 | | |

② Tape material

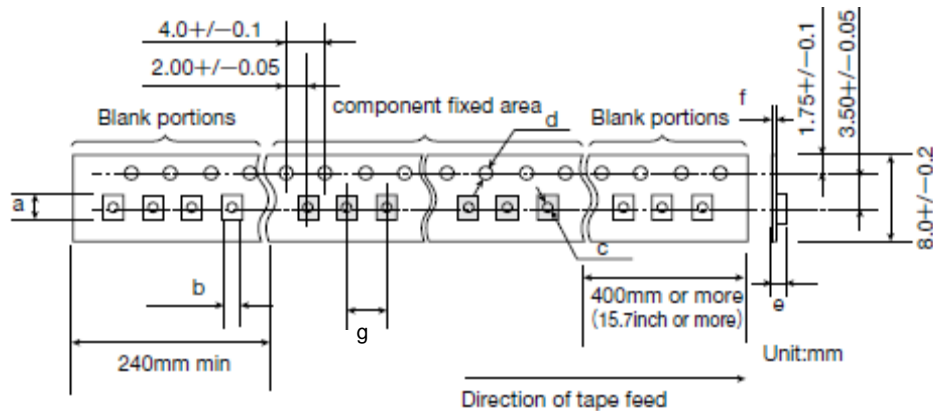

● Taping dimensions

| Type | Size[mm] | a | b | c | d | e | f | g |
|---------------|-----------|-----------|-----------|-----------------|-----------------|-------------------|-------------|------------|
| Duplexer | 2.0 × 1.6 | 2.4 ± 0.1 | 2.0 ± 0.1 | 1.05 ± 0.05 | 1.5 + 0.1 / - 0 | 0.90 - 0.05 | 0.25 ± 0.05 | 4.0 ± 0.1 |
| | 1.8 × 1.4 | 2.2 ± 0.1 | 1.8 ± 0.1 | 0.5 ± 0.05 | 1.55 ± 0.05 | 0.8 ± 0.1 | 0.30 ± 0.05 | 4.0 ± 0.1 |
| Quadplexer | 2.5 × 2.0 | 2.8 ± 0.1 | 2.3 ± 0.1 | 1.5 + 0.1 / - 0 | 1.5 + 0.1 / - 0 | 1.0 + 0.1 / - 0.0 | 0.25 ± 0.05 | 4.0 ± 0.1 |
| Triplexer | 2.5 × 2.0 | 2.8 ± 0.1 | 2.3 ± 0.1 | 1.5 + 0.1 / - 0 | 1.5 + 0.1 / - 0 | 1.0 + 0.1 / - 0.0 | 0.25 ± 0.05 | 4.0 ± 0.1 |
| Single Filter | 2.0 × 1.6 | 2.4 ± 0.1 | 2.0 ± 0.1 | 1.05 ± 0.05 | 1.5 + 0.1 / - 0 | 0.90 - 0.05 | 0.25 ± 0.05 | 4.0 ± 0.1 |
| | 1.8 × 1.4 | 2.2 ± 0.1 | 1.8 ± 0.1 | 0.5 ± 0.05 | 1.55 ± 0.05 | 0.8 ± 0.1 | 0.30 ± 0.05 | 4.0 ± 0.1 |
| | 1.4 × 1.0 | 1.7 ± 0.1 | 1.3 ± 0.1 | 0.5 ± 0.05 | 1.5 + 0.1 / - 0 | 0.63 ± 0.05 | 0.20 ± 0.05 | 4.0 ± 0.1 |
| | 1.1 × 0.9 | 1.3 ± 0.1 | 1.1 ± 0.1 | 0.5 ± 0.05 | 1.55 ± 0.05 | 0.63 ± 0.05 | 0.20 ± 0.05 | 2.0 ± 0.05 |
| Dual Filter | 1.8 × 1.4 | 2.2 ± 0.1 | 1.8 ± 0.1 | 0.5 ± 0.05 | 1.55 ± 0.05 | 0.8 ± 0.1 | 0.30 ± 0.05 | 4.0 ± 0.1 |
| | 1.5 × 1.1 | 1.8 ± 0.1 | 1.4 ± 0.1 | 0.5 ± 0.05 | 1.5 + 0.1 / - 0 | 0.7 ± 0.1 | 0.25 ± 0.05 | 4.0 ± 0.1 |
| Triple Filter | 1.8 × 1.4 | 2.2 ± 0.1 | 1.8 ± 0.1 | 0.5 ± 0.05 | 1.55 ± 0.05 | 0.8 ± 0.1 | 0.30 ± 0.05 | 4.0 ± 0.1 |

単位: mm

● Material of Tape (Conductive)

Tape : Polystyrene

Top cover tape : Polyethylene terephthalate (PET) and Polyethylene

③ Top Tape Strength

The top tape requires a peel-off force of 0.1 to 1.0N in the direction of the arrow as illustrated below.

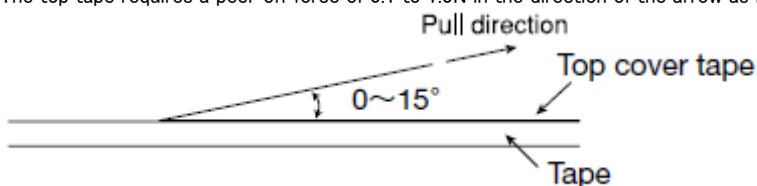

▶ This catalog contains the typical specification only due to the limitation of space. When you consider the purchase of our products, please check our specification. For details of each product (characteristics graph, reliability information, precautions for use, and so on), see our Web site (<http://www.ty-top.com/>).

④ Reel size

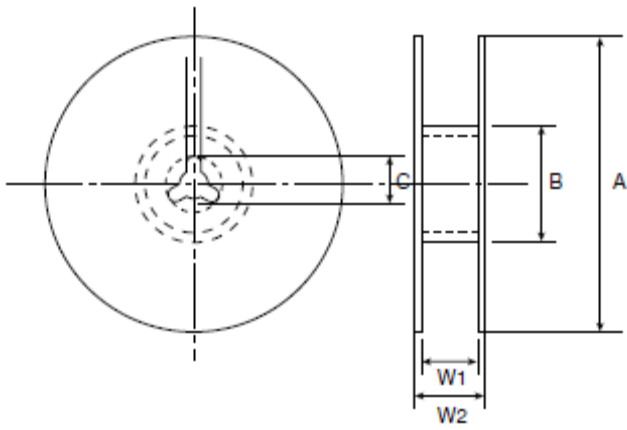

● Material of Reel

Material : Polystyrene + Carbon

Characteristics : Conform to EIAJ-ET-7200A

Color : Black

Surface resistance (reference value) : 109 Ω/sq Max.

| Code | Quantity | A | B | C | W1 | W2 |
|------|------------|-------------------|--------------|-------------|---------------|-----------|
| X | 10,000 pcs | φ 180.0 +0.0/-1.5 | φ 66.0 ±0.5 | φ 13.0 ±0.2 | 9.0 +1.0/-0.0 | 11.4 ±1.0 |
| U | 10,000 pcs | φ 180.0 +0.0/-1.5 | φ 66.0 ±0.5 | φ 13.0 ±0.2 | 9.0 +1.0/-0.0 | 11.4 ±1.0 |
| Y | 15,000 pcs | φ 330.0 ±2.0 | φ 100.0 ±1.0 | φ 13.0 ±0.2 | 9.4 ±1.0 | 13.4 ±1.0 |
| J | 5,000 pcs | φ 180.0 +0.0/-1.5 | φ 66.0 ±0.5 | φ 13.0 ±0.2 | 9.0 +1.0/-0.0 | 11.4 ±1.0 |
| Z | 3,000 pcs | φ 180.0 +0.0/-1.5 | φ 66.0 ±0.5 | φ 13.0 ±0.2 | 9.0 +1.0/-0.0 | 11.4 ±1.0 |

Unit: mm

⑤ Reel label and Reel C-Label sticking and Winding method

● Surface

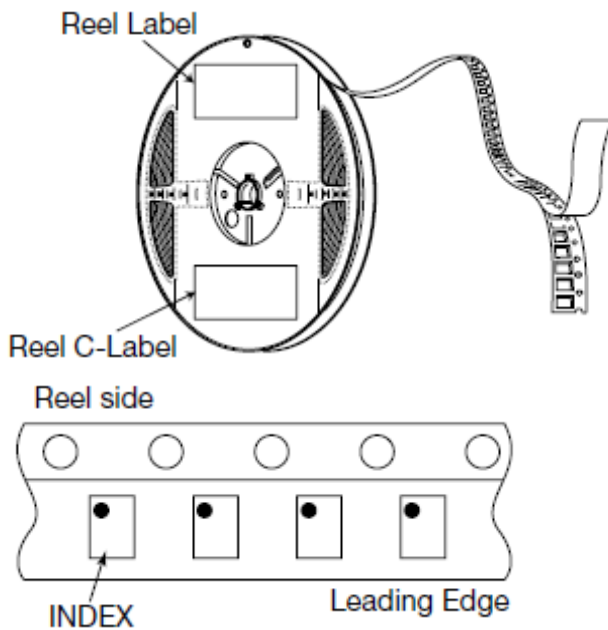

FBAR/SAW DEVICES for MOBILE COMMUNICATIONS

RELIABILITY DATA

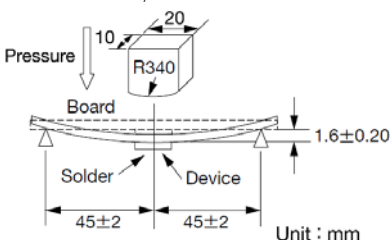
| 1. Terminal strength | |
|----------------------------------|------------------------------------------------------------------------------------------------------------------------------------------------------------------------------------------------------------------|
| Specified Value | No damage to be found. |
| Test Methods and Remarks | <p>Bend width 4mm, hold for 5 ± 1 sec.</p>  <p>Unit : mm</p> |
| 2. Mechanical shock | |
| Specified Value | After testing, meet the specified characteristics at a room temperature. |
| Test Methods and Remarks | Apply 14700m/s^2 for 0.5ms 5 times for each of 6 directions. |
| 3. Vibration | |
| Specified Value | After testing, meet the specified characteristics at a room temperature. |
| Test Methods and Remarks | With 1.5 mm of whole amplitude at 10 to 55 Hz of frequency, and 98m/s^2 of acceleration at 55 to 500Hz, apply a vibration for 2 hours for each of 3 directions, period is 15 minutes(10 to 500 to 10Hz) |
| 4. Drop 1 | |
| Specified Value | After testing, meet the specified characteristics at a room temperature. |
| Test Methods and Remarks | Drop 3 times onto concrete floor from the height of 1.0m. |
| 5. Drop 2 | |
| Specified Value | After testing, meet the specified characteristics at a room temperature. |
| Test Methods and Remarks | Drop with 150g weight 3 times in each 6 direction onto concrete floor from the height of 1.8m. |
| 6. Temperature cycling | |
| Specified Value | After testing, meet the specified characteristics at a room temperature. |
| Test Methods and Remarks | Temp. range -40 to $+100^\circ\text{C}$. 500cycle. |
| 7. Static humidity | |
| Specified Value | After testing, meet the specified characteristics at a room temperature. |
| Test Methods and Remarks | <p>SAW : $+85^\circ\text{C}$, 90% to 95%RH, apply DC5V, 1000hours.</p> <p>FBAR : $+85^\circ\text{C}$, 90% to 95%RH, apply DC0V, 1000hours.</p> |
| 8. High temperature storage life | |
| Specified Value | After testing, meet the specified characteristics at a room temperature. |
| Test Methods and Remarks | $+100^\circ\text{C}$, 1000hours. |
| 9. Low temperature storage life | |
| Specified Value | After testing, meet the specified characteristics at a room temperature. |
| Test Methods and Remarks | -40°C , 1000hours. |

▶ This catalog contains the typical specification only due to the limitation of space. When you consider the purchase of our products, please check our specification. For details of each product (characteristics graph, reliability information, precautions for use, and so on), see our Web site (<http://www.ty-top.com/>).

10. High Temperature Bias

| | |
|--------------------------|--------------------------------------------------------------------------|
| Specified Value | After testing, meet the specified characteristics at a room temperature. |
| Test Methods and Remarks | Please refer to individual specifications in detail. |

11. Solderability

| | |
|--------------------------|----------------------------------------------------------------------------------------------------------------------------|
| Specified Value | More than 90% of area of terminals to be covered with the solder. A change of the remarkable appearance do not have it. |
| Test Methods and Remarks | Lead-free Solder paste, Reflow ; Peak temperature 245°C |

12. Solder heat resistance

| | |
|--------------------------|-----------------------------------------------------------------------------------------------------------------------------------------------------------------------------------------------------------------------------------------------------------------------------------------------------------------------------------------------------------|
| Specified Value | After testing, meet the specified characteristics at a room temperature. A change of the remarkable appearance do not have it. |
| Test Methods and Remarks | <p>◆ Recommended temperature profile of reflow soldering Figure shows recommended temperature profile of reflow soldering in the case of lead-free solder alloy Sn3.0Ag0.5Cu. Suitable condition for solder heating is differed depending on composition and manufacturing method. Please contact to solder manufacturer for the details.</p> |

※ According to JIS(IEC) standard.

FBAR/SAW DEVICES for MOBILE COMMUNICATIONS

■ PRECAUTIONS

1. Storage conditions

| | |
|--------------------------|------------------------------------------------------------------------------------------------------------------------------------------------------------------------------------------------------------------------------------------------------------------------------------------------------------------------------------------------------------------------------------------------------------------------------------------------------------------------------------------------------------------------------------------------------------------------------------------------------------------------------------------------------------------------------------------------------------------------------------------------------------------------------------------------|
| Precautions | <p>◆Storage</p> <p>1. To maintain the solderability of terminal electrodes and to keep the packaging material in good condition, care must be taken to control temperature and humidity in the storage area. Humidity should especially be kept as low as possible.</p> <ul style="list-style-type: none">• Recommended conditions Ambient temperature : $-5 \sim +40^{\circ}\text{C}$ Humidity : 40~85%RH The ambient temperature must be kept below 30°C. Even under ideal storage conditions, the solderability of electrodes decreases gradually, so filters should be mounted within 1 year from the time of delivery.• The packaging material should be kept where no chlorine or sulfur exists in the air. |
| Technical considerations | <p>◆Storage</p> <p>1. If the parts are stocked in a high temperature and humidity environment, problems such as reduced solderability caused by oxidation of terminal electrodes and deterioration of taping/ packaging materials may take place. For this reason, components should be used within 1 year from the time of delivery. If exceeding the above period, please check the solderability before using the filter.</p> |

- Please contact our sales offices for further details of specifications.
All of the standard values listed here are subject to change without notice.
Therefore, please check the specifications carefully before use.

X-ON Electronics

Largest Supplier of Electrical and Electronic Components

Click to view similar products for [Signal Conditioning](#) category:

Click to view products by [Taiyo Yuden](#) manufacturer:

Other Similar products are found below :

[MAPDCC0004](#) [PD0409J5050S2HF](#) [880157](#) [HHS-109-PIN](#) [DC1417J5005AHF](#) [DC4859J5005AHF](#) [AFS14A30-2185.00-T3](#) [AFS14A35-1591.50-T3](#) [DS-323-PIN](#) [DSS-313-PIN](#) [B39321R801H210](#) [B39321R821H210](#) [B39921B4317P810](#) [1A0220-3](#) [2089-6207-00](#) [JP510S](#) [LFB212G45SG8C341](#) [LFB322G45SN1A504](#) [LFL182G45TC3B746](#) [SF2159E](#) [30057](#) [1P510S](#) [CER0813B](#) [3A325](#) [40287](#) [41180](#) [ATB3225-75032NCT](#) [B69842N5807A150](#) [BD0810N50100AHF](#) [BD2326L50200AHF](#) [BD2425J50200AHF](#) [HMC189AMS8TR](#) [C5060J5003AHF](#) [JHS-114-PIN](#) [JP503AS](#) [DC0710J5005AHF](#) [DC2327J5005AHF](#) [DC3338J5005AHF](#) [43020](#) [LFB2H2G60BB1C106](#) [LFL15869MTC1B787](#) [X3C19F1-20S](#) [XC3500P-20S](#) [10013-20](#) [SF2081E](#) [SF2194E](#) [SF2238E](#) [CDBLB455KCAX39-B0](#) [RF1353C](#) [PD0922J5050D2HF](#)