

Notice for TAIYO YUDEN products

Please read this notice before using the TAIYO YUDEN products.

⚠️ REMINDERS

■ Product Information in this Catalog

Product information in this catalog is as of January 2021. All of the contents specified herein and production status of the products listed in this catalog are subject to change without notice due to technical improvement of our products, etc. Therefore, please check for the latest information carefully before practical application or use of our products.

Please note that TAIYO YUDEN shall not be in any way responsible for any damages and defects in products or equipment incorporating our products, which are caused under the conditions other than those specified in this catalog or individual product specification sheets.

■ Approval of Product Specifications

Please contact TAIYO YUDEN for further details of product specifications as the individual product specification sheets are available. When using our products, please be sure to approve our product specifications or make a written agreement on the product specification with TAIYO YUDEN in advance.

■ Pre-Evaluation in the Actual Equipment and Conditions

Please conduct validation and verification of our products in actual conditions of mounting and operating environment before using our products.

■ Limited Application

1. Equipment Intended for Use

The products listed in this catalog are intended for general-purpose and standard use in general electronic equipment (e.g., AV equipment, OA equipment, home electric appliances, office equipment, information and communication equipment including, without limitation, mobile phone, and PC) and other equipment specified in this catalog or the individual product specification sheets.

TAIYO YUDEN has the line-up of the products intended for use in automotive electronic equipment, telecommunications infrastructure and industrial equipment, or medical devices classified as GHTF Classes A to C (Japan Classes I to III). Therefore, when using our products for these equipment, please check available applications specified in this catalog or the individual product specification sheets and use the corresponding products.

2. Equipment Requiring Inquiry

Please be sure to contact TAIYO YUDEN for further information before using the products listed in this catalog for the following equipment (excluding intended equipment as specified in this catalog or the individual product specification sheets) which may cause loss of human life, bodily injury, serious property damage and/or serious public impact due to a failure or defect of the products and/or malfunction attributed thereto.

- (1) Transportation equipment (automotive powertrain control system, train control system, and ship control system, etc.)
- (2) Traffic signal equipment
- (3) Disaster prevention equipment, crime prevention equipment
- (4) Medical devices classified as GHTF Class C (Japan Class III)
- (5) Highly public information network equipment, data-processing equipment (telephone exchange, and base station, etc.)
- (6) Any other equipment requiring high levels of quality and/or reliability equal to the equipment listed above

3. Equipment Prohibited for Use

Please do not incorporate our products into the following equipment requiring extremely high levels of safety and/or reliability.

- (1) Aerospace equipment (artificial satellite, rocket, etc.)
- (2) Aviation equipment *¹
- (3) Medical devices classified as GHTF Class D (Japan Class IV), implantable medical devices *²

- (4) Power generation control equipment (nuclear power, hydroelectric power, thermal power plant control system, etc.)
- (5) Undersea equipment (submarine repeating equipment, underwater work equipment, etc.)
- (6) Military equipment
- (7) Any other equipment requiring extremely high levels of safety and/or reliability equal to the equipment listed above

*Notes:

1. There is a possibility that our products can be used only for aviation equipment that does not directly affect the safe operation of aircraft (e.g., in-flight entertainment, cabin light, electric seat, cooking equipment) if such use meets requirements specified separately by TAIYO YUDEN. Please be sure to contact TAIYO YUDEN for further information before using our products for such aviation equipment.
2. Implantable medical devices contain not only internal unit which is implanted in a body, but also external unit which is connected to the internal unit.

4. Limitation of Liability

Please note that unless you obtain prior written consent of TAIYO YUDEN, TAIYO YUDEN shall not be in any way responsible for any damages incurred by you or third parties arising from use of the products listed in this catalog for any equipment that is not intended for use by TAIYO YUDEN, or any equipment requiring inquiry to TAIYO YUDEN or prohibited for use by TAIYO YUDEN as described above.

■ Safety Design

When using our products for high safety and/or reliability-required equipment or circuits, please fully perform safety and/or reliability evaluation. In addition, please install (i) systems equipped with a protection circuit and a protection device and/or (ii) systems equipped with a redundant circuit or other system to prevent an unsafe status in the event of a single fault for a failsafe design to ensure safety.

■ Intellectual Property Rights

Information contained in this catalog is intended to convey examples of typical performances and/or applications of our products and is not intended to make any warranty with respect to the intellectual property rights or any other related rights of TAIYO YUDEN or any third parties nor grant any license under such rights.

■ Limited Warranty

Please note that the scope of warranty for our products is limited to the delivered our products themselves and TAIYO YUDEN shall not be in any way responsible for any damages resulting from a failure or defect in our products. Notwithstanding the foregoing, if there is a written agreement (e.g., supply and purchase agreement, quality assurance agreement) signed by TAIYO YUDEN and your company, TAIYO YUDEN will warrant our products in accordance with such agreement.

■ TAIYO YUDEN's Official Sales Channel

The contents of this catalog are applicable to our products which are purchased from our sales offices or authorized distributors (hereinafter "TAIYO YUDEN's official sales channel"). Please note that the contents of this catalog are not applicable to our products purchased from any seller other than TAIYO YUDEN's official sales channel.

■ Caution for Export

Some of our products listed in this catalog may require specific procedures for export according to "U.S. Export Administration Regulations", "Foreign Exchange and Foreign Trade Control Law" of Japan, and other applicable regulations. Should you have any questions on this matter, please contact our sales staff.

▶ This catalog contains the typical specification only due to the limitation of space. When you consider the purchase of our products, please check our product specification sheets. For details of each product (characteristics graph, reliability information, precautions for use, and so on), see our website (<http://www.ty-top.com/>).

MULTILAYER CERAMIC CAPACITORS

WAVE REFLOW

PARTS NUMBER

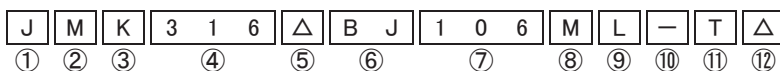

△ = Blank space

① Rated voltage

Code	Rated voltage [VDC]
P	2.5
A	4
J	6.3
L	10
E	16
T	25
G	35
U	50
H	100
Q	250
S	630
X	2000

② Series name

Code	Series name
M	Multilayer ceramic capacitor
V	Multilayer ceramic capacitor for high frequency
W	LW reverse type multilayer capacitor

③ End termination

Code	End termination
K	Plated
S	Cu Internal Electrodes (For High Frequency)

④ Dimension (L × W)

Type	Dimensions (L × W) [mm]	EIA (inch)
021	0.25 × 0.125	008004
042	0.4 × 0.2	01005
063	0.6 × 0.3	0201
105	1.0 × 0.5	0402
	0.52 × 1.0 ※	0204
107	1.6 × 0.8	0603
	0.8 × 1.6 ※	0306
212	2.0 × 1.25	0805
	1.25 × 2.0 ※	0508
316	3.2 × 1.6	1206
325	3.2 × 2.5	1210
432	4.5 × 3.2	1812

Note : ※LW reverse type (□WK) only

⑤ Dimension tolerance

Code	Type	L [mm]	W [mm]	T [mm]
△	ALL	Standard	Standard	Standard
	063	0.6 ± 0.05	0.3 ± 0.05	0.3 ± 0.05
	105	1.0 ± 0.10	0.5 ± 0.10	0.5 ± 0.10
	107	1.6 + 0.15 / - 0.05	0.8 + 0.15 / - 0.05	0.8 + 0.15 / - 0.05
A	212	2.0 + 0.15 / - 0.05	1.25 + 0.15 / - 0.05	0.45 ± 0.05 0.85 ± 0.10 1.25 + 0.15 / - 0.05
	316	3.2 ± 0.20	1.6 ± 0.20	0.85 ± 0.10 1.6 ± 0.20
	325	3.2 ± 0.30	2.5 ± 0.30	2.5 ± 0.30
	063	0.6 ± 0.09	0.3 ± 0.09	0.3 ± 0.09
B	105	1.0 + 0.15 / - 0.05	0.5 + 0.15 / - 0.05	0.5 + 0.15 / - 0.05
	107	1.6 + 0.20 / - 0	0.8 + 0.20 / - 0	0.45 ± 0.05 0.8 + 0.20 / - 0
	212	2.0 + 0.20 / - 0	1.25 + 0.20 / - 0	0.45 ± 0.05 0.85 ± 0.10 1.25 + 0.20 / - 0
	316	3.2 ± 0.30	1.6 ± 0.30	1.6 ± 0.30
C	105	1.0 + 0.20 / - 0	0.5 + 0.20 / - 0	0.5 + 0.20 / - 0
E	063	0.6 + 0.25 / - 0	0.3 + 0.25 / - 0	0.3 + 0.25 / - 0
	105	1.0 + 0.30 / - 0	0.5 + 0.30 / - 0	0.5 + 0.30 / - 0

Note: cf. STANDARD EXTERNAL DIMENSIONS

△ = Blank space

⑥ Temperature characteristics code

■ High dielectric type (Excluding Super low distortion multilayer ceramic capacitor)

Code	Applicable standard	Temperature range [°C]	Ref. Temp. [°C]	Capacitance change	Capacitance tolerance	Tolerance code
BJ	JIS	B	-25 ~ + 85	20	± 10%	± 10%
	EIA					X5R
B7	EIA	X7R	-55 ~ + 125	25	± 15%	± 10%
						± 20%
C6	EIA	X6S	-55 ~ + 105	25	± 22%	± 10%
						± 20%
C7	EIA	X7S	-55 ~ + 125	25	± 22%	± 10%
						± 20%
LD(※)	EIA	X5R	-55 ~ + 85	25	± 15%	± 10%
						± 20%

Note : ※LD Low distortion high value multilayer ceramic capacitor

△ = Blank space

▶ This catalog contains the typical specification only due to the limitation of space. When you consider the purchase of our products, please check our product specification sheets. For details of each product (characteristics graph, reliability information, precautions for use, and so on), see our website (<http://www.ty-top.com/>).

■ Temperature compensating type

Code	Applicable standard		Temperature range [°C]	Ref. Temp. [°C]	Capacitance change	Capacitance tolerance	Tolerance code
CG	EIA	C0G	-55~+125	25	0±30ppm/°C	±0.05pF	A
						±0.1pF	B
						±0.25pF	C
						±0.5pF	D
						±5%	J
UJ	JIS	UJ	-55~+125	20	-750±120ppm/°C	±0.25pF	C
		U2J				±0.5pF	D
	EIA		25	±5%		J	
UK	JIS	UK	-55~+125	20	-750±250ppm/°C	±0.25pF	C
	EIA	U2K	-55~+125	25			

⑥ Series code

• Super low distortion multilayer ceramic capacitor

Code	Series code
SD	Standard

• Medium-High Voltage Multilayer Ceramic Capacitor

Code	Series code
SD	Standard

⑦ Nominal capacitance

Code (example)	Nominal capacitance
0R5	0.5pF
010	1pF
100	10pF
101	100pF
102	1,000pF
103	10,000pF
104	0.1 μF
105	1.0 μF
106	10 μF
107	100 μF

Note : R=Decimal point

⑧ Capacitance tolerance

Code	Capacitance tolerance
A	±0.05pF
B	±0.1pF
C	±0.25pF
D	±0.5pF
F	±1pF
G	±2%
J	±5%
K	±10%
M	±20%
Z	+80/-20%

⑨ Thickness

Code	Thickness [mm]
K	0.125
H	0.13
E	0.18
C	0.2
D	
P	0.3
T	
K	0.45 (107type or more)
V	0.5
W	
A	0.8
D	0.85 (212type or more)
F	1.15
G	1.25
L	1.6
N	1.9
Y	2.0 max
M	2.5

⑩ Special code

Code	Special code
-	Standard

⑪ Packaging

Code	Packaging
F	φ 178mm Taping (2mm pitch)
T	φ 178mm Taping (4mm pitch)
P	φ 178mm Taping (4mm pitch, 1000 pcs/reel) 325 type (Thickness code M)
R	φ 178mm Taping (2mm pitch) 105type only (Thickness code E,H)
W	φ 178mm Taping (1mm pitch) 021/042type only

⑫ Internal code

Code	Internal code
△	Standard

► This catalog contains the typical specification only due to the limitation of space. When you consider the purchase of our products, please check our product specification sheets. For details of each product (characteristics graph, reliability information, precautions for use, and so on), see our website (<http://www.ty-top.com/>).

STANDARD EXTERNAL DIMENSIONS

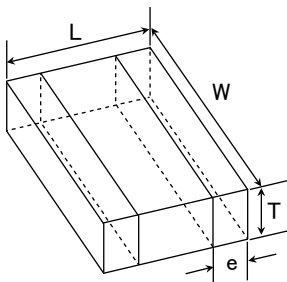
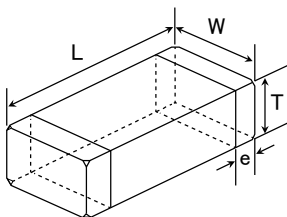

※ LW reverse type

Type(EIA)	Dimension [mm]					
	L	W	T	*1	e	
□MK021(008004)	0.25±0.013	0.125±0.013	0.125±0.013	K	0.0675±0.0275	
□VS021(008004)	0.25±0.013	0.125±0.013	0.125±0.013	K	0.0675±0.0275	
□MK042(01005)	0.4±0.02	0.2±0.02	0.2±0.02	C	0.1±0.03	
□VS042(01005)				D		
□MK063(0201)	0.6±0.03	0.3±0.03	0.3±0.03	P	0.15±0.05	
□MK105(0402)				T		
□MK105(0402)	1.0±0.05	0.5±0.05	0.13±0.02	H	0.25±0.10	
				0.18±0.02		E
				0.2±0.02		C
				0.3±0.03		P
				0.5±0.05		V
□VK105(0402)	1.0±0.05	0.5±0.05	0.5±0.05	W	0.25±0.10	
□WK105(0204)※	0.52±0.05	1.0±0.05	0.3±0.05	P	0.18±0.08	
□MK107(0603)	1.6±0.10	0.8±0.10	0.45±0.05	K	0.35±0.25	
			0.8±0.10	A		
□WK107(0306)※	0.8±0.10	1.6±0.10	0.5±0.05	V	0.25±0.15	
□MK212(0805)	2.0±0.10	1.25±0.10	0.45±0.05	K	0.5±0.25	
			0.85±0.10	D		
			1.25±0.10	G		
□WK212(0508)※	1.25±0.15	2.0±0.15	0.85±0.10	D	0.3±0.2	
□MK316(1206)	3.2±0.15	1.6±0.15	0.85±0.10	D	0.5+0.35/-0.25	
			1.15±0.10	F		
			1.6±0.20	L		
□MK325(1210)	3.2±0.30	2.5±0.20	0.85±0.10	D	0.6±0.3	
			1.15±0.10	F		
			1.9±0.20	N		
			1.9+0.1/-0.2	Y		
			2.5±0.20	M		
□MK432(1812)	4.5±0.40	3.2±0.30	2.0+0/-0.30	Y	0.6±0.4	
			2.5±0.20	M	0.9±0.6	

Note : ※. LW reverse type, *1.Thickness code

STANDARD QUANTITY

Type	EIA (inch)	Dimension		Standard quantity [pcs]		
		[mm]	Code	Paper tape	Embossed tape	
021	008004	0.125	K	—	50000	
042	01005	0.2	C	—	40000	
			D			
063	0201	0.3	P	15000	—	
			T			
105	0402	0.13	H	—	20000	
			0.18	E	—	15000
			0.2	C	20000	—
			0.3	P	15000	—
			0.5	V	10000	—
				W		
0204 ※	0.30	P	—	—		
107	0603	0.45	K	4000	—	
			A			
	0306 ※	0.50	V	—	4000	
212	0805	0.45	K	4000	—	
			0.85			D
			1.25			G
0508 ※	0.85	D	4000	—		
316	1206	0.85	D	4000	—	
			1.15	F	—	3000
			1.6	L	—	2000
325	1210	0.85	D	—	2000	
			1.15			F
			1.9			N
			2.0 max			Y
			2.5			M
432	1812	2.0 max	Y	—	1000	
			2.5	M	—	500

Note : ※.LW Reverse type (□WK)

PARTS NUMBER

Medium-High Voltage Multilayer Ceramic Capacitors

105TYPE

[Temperature Characteristic B7 : X7R (-55~+125°C)] 0.5mm thickness (V)

Part number 1	Part number 2	Rated voltage [V]	Temperature characteristics		Capacitance [F]	Capacitance tolerance [%]	tan δ [%]	HTLT	Thickness*3 [mm]	Soldering R:Reflow W:Wave
								Rated voltage x %		
HMK105 B7221□V-F		100		X7R	220 p	±10, ±20	2.5	200	0.5±0.05	R
HMK105 B7331□V-F				X7R	330 p	±10, ±20	2.5	200	0.5±0.05	R
HMK105 B7471□V-F				X7R	470 p	±10, ±20	2.5	200	0.5±0.05	R
HMK105 B7681□V-F				X7R	680 p	±10, ±20	2.5	200	0.5±0.05	R
HMK105 B7102□V-F				X7R	1000 p	±10, ±20	2.5	200	0.5±0.05	R
HMK105 B7152□V-F				X7R	1500 p	±10, ±20	2.5	200	0.5±0.05	R
HMK105 B7222□V-F				X7R	2200 p	±10, ±20	2.5	200	0.5±0.05	R
HMK105 B7332□V-F				X7R	3300 p	±10, ±20	2.5	200	0.5±0.05	R
HMK105 B7472□V-F				X7R	4700 p	±10, ±20	2.5	200	0.5±0.05	R
HMK105 B7682□V-F				X7R	6800 p	±10, ±20	2.5	200	0.5±0.05	R

[Temperature Characteristic CG : CG/C0G (-55~+125°C)] 0.5mm thickness (V)

Part number 1	Part number 2	Rated voltage [V]	Temperature characteristics		Capacitance [F]	Capacitance tolerance [%]	Q (at 1MHz) min	HTLT	Thickness*3 [mm]	Soldering R:Reflow W:Wave
								Rated voltage x %		
HMK105 CG080DV-F		100	CG	C0G	8 p	±0.5pF	560	200	0.5±0.05	R
HMK105 CG090DV-F			CG	C0G	9 p	±0.5pF	580	200	0.5±0.05	R
HMK105 CG100DV-F			CG	C0G	10 p	±0.5pF	600	200	0.5±0.05	R
HMK105 CG120JV-F			CG	C0G	12 p	±5%	640	200	0.5±0.05	R
HMK105 CG150JV-F			CG	C0G	15 p	±5%	700	200	0.5±0.05	R
HMK105 CG180JV-F			CG	C0G	18 p	±5%	760	200	0.5±0.05	R
HMK105 CG220JV-F			CG	C0G	22 p	±5%	840	200	0.5±0.05	R
HMK105 CG240JV-F			CG	C0G	24 p	±5%	880	200	0.5±0.05	R
HMK105 CG270JV-F			CG	C0G	27 p	±5%	940	200	0.5±0.05	R
HMK105 CG330JV-F			CG	C0G	33 p	±5%	1000	200	0.5±0.05	R
HMK105 CG390JV-F			CG	C0G	39 p	±5%	1000	200	0.5±0.05	R
HMK105 CG470JV-F			CG	C0G	47 p	±5%	1000	200	0.5±0.05	R
HMK105 CG560JV-F			CG	C0G	56 p	±5%	1000	200	0.5±0.05	R
HMK105 CG680JV-F			CG	C0G	68 p	±5%	1000	200	0.5±0.05	R
HMK105 CG820JV-F			CG	C0G	82 p	±5%	1000	200	0.5±0.05	R
HMK105 CG101JV-F			CG	C0G	100 p	±5%	1000	200	0.5±0.05	R

107TYPE

[Temperature Characteristic BJ : B (-25~+85°C)/X5R (-55~+85°C)] 0.8mm thickness (A)

Part number 1	Part number 2	Rated voltage [V]	Temperature characteristics		Capacitance [F]	Capacitance tolerance [%]	tan δ [%]	HTLT	Thickness*3 [mm]	Soldering R:Reflow W:Wave
								Rated voltage x %		
HMK107 BJ102□A-T		100	B	X5R ⁺	1000 p	±10, ±20	3.5	200	0.8±0.10	R
HMK107 BJ152□A-T			B	X5R ⁺	1500 p	±10, ±20	3.5	200	0.8±0.10	R
HMK107 BJ222□A-T			B	X5R ⁺	2200 p	±10, ±20	3.5	200	0.8±0.10	R
HMK107 BJ332□A-T			B	X5R ⁺	3300 p	±10, ±20	3.5	200	0.8±0.10	R
HMK107 BJ472□A-T			B	X5R ⁺	4700 p	±10, ±20	3.5	200	0.8±0.10	R
HMK107 BJ682□A-T			B	X5R ⁺	6800 p	±10, ±20	3.5	200	0.8±0.10	R
HMK107 BJ103□A-T			B	X5R ⁺	0.01 μ	±10, ±20	3.5	200	0.8±0.10	R
HMK107 BJ153□A-T			B	X5R ⁺	0.015 μ	±10, ±20	3.5	200	0.8±0.10	R
HMK107 BJ223□A-T			B	X5R ⁺	0.022 μ	±10, ±20	3.5	200	0.8±0.10	R
HMK107 BJ333□A-T			B	X5R ⁺	0.033 μ	±10, ±20	3.5	200	0.8±0.10	R
HMK107 BJ473□A-T			B	X5R ⁺	0.047 μ	±10, ±20	3.5	200	0.8±0.10	R
HMK107 BJ104□A-T			B	X5R ⁺	0.1 μ	±10, ±20	3.5	200	0.8±0.10	R
HMK107 BJ224□A-TE			B	X5R ⁺	0.22 μ	±10, ±20	3.5	150	0.8±0.10	R

[Temperature Characteristic C7 : X7S (-55~+125°C)] 0.8mm thickness (A)

Part number 1	Part number 2	Rated voltage [V]	Temperature characteristics		Capacitance [F]	Capacitance tolerance [%]	tan δ [%]	HTLT	Thickness*3 [mm]	Soldering R:Reflow W:Wave
								Rated voltage x %		
HMK107 C7224□A-TE		100		X7S	0.22 μ	±10, ±20	3.5	150	0.8±0.10	R

[Temperature Characteristic B7 : X7R (-55~+125°C)] 0.8mm thickness (A)

Part number 1	Part number 2	Rated voltage [V]	Temperature characteristics		Capacitance [F]	Capacitance tolerance [%]	tan δ [%]	HTLT	Thickness*3 [mm]	Soldering R:Reflow W:Wave
								Rated voltage x %		
HMK107 B7102□A-T		100		X7R	1000 p	±10, ±20	3.5	200	0.8±0.10	R
HMK107 B7152□A-T				X7R	1500 p	±10, ±20	3.5	200	0.8±0.10	R
HMK107 B7222□A-T				X7R	2200 p	±10, ±20	3.5	200	0.8±0.10	R
HMK107 B7332□A-T				X7R	3300 p	±10, ±20	3.5	200	0.8±0.10	R
HMK107 B7472□A-T				X7R	4700 p	±10, ±20	3.5	200	0.8±0.10	R
HMK107 B7682□A-T				X7R	6800 p	±10, ±20	3.5	200	0.8±0.10	R
HMK107 B7103□A-T				X7R	0.01 μ	±10, ±20	3.5	200	0.8±0.10	R
HMK107 B7153□A-T				X7R	0.015 μ	±10, ±20	3.5	200	0.8±0.10	R
HMK107 B7223□A-T				X7R	0.022 μ	±10, ±20	3.5	200	0.8±0.10	R
HMK107 B7333□A-T				X7R	0.033 μ	±10, ±20	3.5	200	0.8±0.10	R
HMK107 B7473□A-T				X7R	0.047 μ	±10, ±20	3.5	200	0.8±0.10	R
HMK107 B7104□A-T				X7R	0.1 μ	±10, ±20	3.5	200	0.8±0.10	R

► This catalog contains the typical specification only due to the limitation of space. When you consider the purchase of our products, please check our product specification sheets. For details of each product (characteristics graph, reliability information, precautions for use, and so on), see our website (<http://www.ty-top.com/>).

PARTS NUMBER

【Temperature Characteristic SD : Standard (−55~+125°C)】 0.8mm thickness (A)

Part number 1	Part number 2	Rated voltage [V]	Temperature characteristics	Capacitance [F]	Capacitance tolerance [%]	tan δ [%]	HTLT	Thickness*3 [mm]	Soldering R:Reflow W:Wave
							Rated voltage x %		
HMK107 SD101KA-T		100	Standard Type	100 p	±10	0.1	200	0.8±0.10	R
HMK107 SD121KA-T				120 p	±10	0.1	200	0.8±0.10	R
HMK107 SD151KA-T				150 p	±10	0.1	200	0.8±0.10	R
HMK107 SD181KA-T				180 p	±10	0.1	200	0.8±0.10	R
HMK107 SD221KA-T				220 p	±10	0.1	200	0.8±0.10	R
HMK107 SD271KA-T				270 p	±10	0.1	200	0.8±0.10	R
HMK107 SD331KA-T				330 p	±10	0.1	200	0.8±0.10	R
HMK107 SD391KA-T				390 p	±10	0.1	200	0.8±0.10	R
HMK107 SD471KA-T				470 p	±10	0.1	200	0.8±0.10	R
HMK107 SD561KA-T				560 p	±10	0.1	200	0.8±0.10	R
HMK107 SD681KA-T				680 p	±10	0.1	200	0.8±0.10	R
HMK107 SD821KA-T				820 p	±10	0.1	200	0.8±0.10	R
HMK107 SD102KA-T				1000 p	±10	0.1	200	0.8±0.10	R

● 212TYPE

【Temperature Characteristic BJ : B (−25~+85°C)/X5R (−55~+85°C)】 1.25mm thickness (G)

Part number 1	Part number 2	Rated voltage [V]	Temperature characteristics	Capacitance [F]	Capacitance tolerance [%]	tan δ [%]	HTLT	Thickness*3 [mm]	Soldering R:Reflow W:Wave			
							Rated voltage x %					
HMK212 BJ103□G-T		100	B	X5R ¹	0.01 μ	±10, ±20	3.5	200	1.25±0.10	R		
HMK212 BJ153□G-T				X5R ¹	0.015 μ	±10, ±20	3.5	200	1.25±0.10	R		
HMK212 BJ223□G-T				X5R ¹	0.022 μ	±10, ±20	3.5	200	1.25±0.10	R		
HMK212 BJ333□G-T				X5R ¹	0.033 μ	±10, ±20	3.5	200	1.25±0.10	R		
HMK212 BJ473□G-T				X5R ¹	0.047 μ	±10, ±20	3.5	200	1.25±0.10	R		
HMK212 BJ683□G-T				X5R ¹	0.068 μ	±10, ±20	3.5	200	1.25±0.10	R		
HMK212 BJ104□G-T				X5R ¹	0.1 μ	±10, ±20	3.5	200	1.25±0.10	R		
HMK212 BJ224□G-T				X5R ¹	0.22 μ	±10, ±20	3.5	200	1.25±0.10	R		
HMK212 BJ474□G-TE				X5R ¹	0.47 μ	±10, ±20	3.5	150	1.25±0.10	R		
HMK212BBJ105□G-TE				X5R ¹	1 μ	±10, ±20	3.5	150	1.25+0.20/-0	R		
QMK212 BJ472□G-T				250	B	X5R ¹	4700 p	±10, ±20	2.5	150	1.25±0.10	R
QMK212 BJ682□G-T						X5R ¹	6800 p	±10, ±20	2.5	150	1.25±0.10	R
QMK212 BJ103□G-T						X5R ¹	0.01 μ	±10, ±20	2.5	150	1.25±0.10	R
QMK212 BJ153□G-T						X5R ¹	0.015 μ	±10, ±20	2.5	150	1.25±0.10	R
QMK212 BJ223□G-T		X5R ¹	0.022 μ			±10, ±20	2.5	150	1.25±0.10	R		

【Temperature Characteristic BJ : B (−25~+85°C)/X5R (−55~+85°C)】 0.85mm thickness (D)

Part number 1	Part number 2	Rated voltage [V]	Temperature characteristics	Capacitance [F]	Capacitance tolerance [%]	tan δ [%]	HTLT	Thickness*3 [mm]	Soldering R:Reflow W:Wave	
							Rated voltage x %			
QMK212 BJ102□D-T		250	B	X5R ¹	1000 p	±10, ±20	2.5	150	0.85±0.10	R
QMK212 BJ152□D-T				X5R ¹	1500 p	±10, ±20	2.5	150	0.85±0.10	R
QMK212 BJ222□D-T				X5R ¹	2200 p	±10, ±20	2.5	150	0.85±0.10	R
QMK212 BJ332□D-T				X5R ¹	3300 p	±10, ±20	2.5	150	0.85±0.10	R

【Temperature Characteristic C7 : X7S (−55~+125°C)】 1.25mm thickness (G)

Part number 1	Part number 2	Rated voltage [V]	Temperature characteristics	Capacitance [F]	Capacitance tolerance [%]	tan δ [%]	HTLT	Thickness*3 [mm]	Soldering R:Reflow W:Wave
							Rated voltage x %		
HMK212 C7474□G-TE		100	X7S	0.47 μ	±10, ±20	3.5	150	1.25±0.10	R
HMK212BC7105□G-TE		100	X7S	1 μ	±10, ±20	3.5	150	1.25+0.20/-0	R

【Temperature Characteristic B7 : X7R (−55~+125°C)】 1.25mm thickness (G)

Part number 1	Part number 2	Rated voltage [V]	Temperature characteristics	Capacitance [F]	Capacitance tolerance [%]	tan δ [%]	HTLT	Thickness*3 [mm]	Soldering R:Reflow W:Wave		
							Rated voltage x %				
HMK212 B7103□G-T		100	X7R	0.01 μ	±10, ±20	3.5	200	1.25±0.10	R		
HMK212 B7153□G-T				0.015 μ	±10, ±20	3.5	200	1.25±0.10	R		
HMK212 B7223□G-T				0.022 μ	±10, ±20	3.5	200	1.25±0.10	R		
HMK212 B7333□G-T				0.033 μ	±10, ±20	3.5	200	1.25±0.10	R		
HMK212 B7473□G-T				0.047 μ	±10, ±20	3.5	200	1.25±0.10	R		
HMK212 B7683□G-T				0.068 μ	±10, ±20	3.5	200	1.25±0.10	R		
HMK212 B7104□G-T				0.1 μ	±10, ±20	3.5	200	1.25±0.10	R		
HMK212 B7224□G-T				0.22 μ	±10, ±20	3.5	200	1.25±0.10	R		
QMK212 B7472□G-T				250	X7R	4700 p	±10, ±20	2.5	150	1.25±0.10	R
QMK212 B7682□G-T						6800 p	±10, ±20	2.5	150	1.25±0.10	R
QMK212 B7103□G-T						0.01 μ	±10, ±20	2.5	150	1.25±0.10	R
QMK212 B7153□G-T						0.015 μ	±10, ±20	2.5	150	1.25±0.10	R
QMK212 B7223□G-T						0.022 μ	±10, ±20	2.5	150	1.25±0.10	R

【Temperature Characteristic B7 : X7R (−55~+125°C)】 0.85mm thickness (D)

Part number 1	Part number 2	Rated voltage [V]	Temperature characteristics	Capacitance [F]	Capacitance tolerance [%]	tan δ [%]	HTLT	Thickness*3 [mm]	Soldering R:Reflow W:Wave
							Rated voltage x %		
QMK212 B7102□D-T		250	X7R	1000 p	±10, ±20	2.5	150	0.85±0.10	R
QMK212 B7152□D-T				1500 p	±10, ±20	2.5	150	0.85±0.10	R
QMK212 B7222□D-T				2200 p	±10, ±20	2.5	150	0.85±0.10	R
QMK212 B7332□D-T				3300 p	±10, ±20	2.5	150	0.85±0.10	R

▶ This catalog contains the typical specification only due to the limitation of space. When you consider the purchase of our products, please check our product specification sheets. For details of each product (characteristics graph, reliability information, precautions for use, and so on), see our website (<http://www.ty-top.com/>).

CERAMIC CAPACITORS MULTILAYER CERAMIC CAPACITORS

PARTS NUMBER

[Temperature Characteristic SD : Standard (-55~+125°C)] 0.85mm thickness (D)

Part number 1	Part number 2	Rated voltage [V]	Temperature characteristics	Capacitance [F]	Capacitance tolerance [%]	tan δ [%]	HTLT	Thickness*3 [mm]	Soldering R:Reflow W:Wave
							Rated voltage x %		
HMK212 SD222KD-T		100	Standard Type	2200 p	±10	0.1	200	0.85±0.10	R
HMK212 SD472KD-T				4700 p	±10	0.1	200	0.85±0.10	R
QMK212 SD101KD-T		250	Standard Type	100 p	±10	0.1	150	0.85±0.10	R
QMK212 SD121KD-T				120 p	±10	0.1	150	0.85±0.10	R
QMK212 SD151KD-T				150 p	±10	0.1	150	0.85±0.10	R
QMK212 SD181KD-T				180 p	±10	0.1	150	0.85±0.10	R
QMK212 SD221KD-T				220 p	±10	0.1	150	0.85±0.10	R
QMK212 SD331KD-T				330 p	±10	0.1	150	0.85±0.10	R
QMK212 SD391KD-T				390 p	±10	0.1	150	0.85±0.10	R
QMK212 SD471KD-T				470 p	±10	0.1	150	0.85±0.10	R
QMK212 SD561KD-T				560 p	±10	0.1	150	0.85±0.10	R
QMK212 SD681KD-T				680 p	±10	0.1	150	0.85±0.10	R
QMK212 SD821KD-T				820 p	±10	0.1	150	0.85±0.10	R
QMK212 SD102KD-T				1000 p	±10	0.1	150	0.85±0.10	R

[Temperature Characteristic SD : Standard (-55~+125°C)] 1.25mm thickness (G)

Part number 1	Part number 2	Rated voltage [V]	Temperature characteristics	Capacitance [F]	Capacitance tolerance [%]	tan δ [%]	HTLT	Thickness*3 [mm]	Soldering R:Reflow W:Wave
							Rated voltage x %		
HMK212 SD392KG-T		100	Standard Type	3900 p	±10	0.1	200	1.25±0.10	R

316TYPE

[Temperature Characteristic BJ : B (-25~+85°C)/X5R (-55~+85°C)] 1.6mm thickness (L)

Part number 1	Part number 2	Rated voltage [V]	Temperature characteristics	Capacitance [F]	Capacitance tolerance [%]	tan δ [%]	HTLT	Thickness*3 [mm]	Soldering R:Reflow W:Wave		
							Rated voltage x %				
HMK316 BJ473□L-T		100	Standard Type	B X5R ⁺ 0.047 μ	±10, ±20	3.5	200	1.6±0.20	R		
HMK316 BJ683□L-T				B X5R ⁺ 0.068 μ	±10, ±20	3.5	200	1.6±0.20	R		
HMK316 BJ104□L-T				B X5R ⁺ 0.1 μ	±10, ±20	3.5	200	1.6±0.20	R		
HMK316 BJ154□L-T				B X5R ⁺ 0.15 μ	±10, ±20	3.5	200	1.6±0.20	R		
HMK316 BJ224□L-T				B X5R ⁺ 0.22 μ	±10, ±20	3.5	200	1.6±0.20	R		
HMK316 BJ334□L-T				B X5R ⁺ 0.33 μ	±10, ±20	3.5	200	1.6±0.20	R		
HMK316 BJ474□L-T				B X5R ⁺ 0.47 μ	±10, ±20	3.5	200	1.6±0.20	R		
HMK316 BJ105□L-T				B X5R ⁺ 1 μ	±10, ±20	3.5	200	1.6±0.20	R		
HMK316ABJ225□L-TE				B X5R ⁺ 2.2 μ	±10, ±20	3.5	150	1.6±0.20	R		
QMK316 BJ333□L-T				250	Standard Type	B X5R ⁺ 0.033 μ	±10, ±20	2.5	150	1.6±0.20	R
QMK316 BJ473□L-T						B X5R ⁺ 0.047 μ	±10, ±20	2.5	150	1.6±0.20	R
QMK316 BJ683□L-T						B X5R ⁺ 0.068 μ	±10, ±20	2.5	150	1.6±0.20	R
QMK316 BJ104□L-T						B X5R ⁺ 0.1 μ	±10, ±20	2.5	150	1.6±0.20	R
SMK316 BJ153□L-T						B X5R ⁺ 0.015 μ	±10, ±20	2.5	120	1.6±0.20	R
SMK316 BJ223□L-T		B X5R ⁺ 0.022 μ	±10, ±20			2.5	120	1.6±0.20	R		

[Temperature Characteristic BJ : B (-25~+85°C)/X5R (-55~+85°C)] 1.15mm thickness (F)

Part number 1	Part number 2	Rated voltage [V]	Temperature characteristics	Capacitance [F]	Capacitance tolerance [%]	tan δ [%]	HTLT	Thickness*3 [mm]	Soldering R:Reflow W:Wave
							Rated voltage x %		
SMK316 BJ102□F-T		630	Standard Type	B X5R ⁺ 1000 p	±10, ±20	2.5	120	1.15±0.10	R
SMK316 BJ152□F-T				B X5R ⁺ 1500 p	±10, ±20	2.5	120	1.15±0.10	R
SMK316 BJ222□F-T				B X5R ⁺ 2200 p	±10, ±20	2.5	120	1.15±0.10	R
SMK316 BJ332□F-T				B X5R ⁺ 3300 p	±10, ±20	2.5	120	1.15±0.10	R
SMK316 BJ472□F-T				B X5R ⁺ 4700 p	±10, ±20	2.5	120	1.15±0.10	R
SMK316 BJ682□F-T				B X5R ⁺ 6800 p	±10, ±20	2.5	120	1.15±0.10	R
SMK316 BJ103□F-T				B X5R ⁺ 0.01 μ	±10, ±20	2.5	120	1.15±0.10	R

[Temperature Characteristic C7 : X7S (-55~+125°C)] 1.6mm thickness (L)

Part number 1	Part number 2	Rated voltage [V]	Temperature characteristics	Capacitance [F]	Capacitance tolerance [%]	tan δ [%]	HTLT	Thickness*3 [mm]	Soldering R:Reflow W:Wave
							Rated voltage x %		
HMK316AC7225□L-TE		100	X7S	2.2 μ	±10, ±20	3.5	150	1.6±0.20	R

[Temperature Characteristic B7 : X7R (-55~+125°C)] 1.6mm thickness (L)

Part number 1	Part number 2	Rated voltage [V]	Temperature characteristics	Capacitance [F]	Capacitance tolerance [%]	tan δ [%]	HTLT	Thickness*3 [mm]	Soldering R:Reflow W:Wave		
							Rated voltage x %				
HMK316 B7473□L-T		100	Standard Type	X7R 0.047 μ	±10, ±20	3.5	200	1.6±0.20	R		
HMK316 B7683□L-T				X7R 0.068 μ	±10, ±20	3.5	200	1.6±0.20	R		
HMK316 B7104□L-T				X7R 0.1 μ	±10, ±20	3.5	200	1.6±0.20	R		
HMK316 B7154□L-T				X7R 0.15 μ	±10, ±20	3.5	200	1.6±0.20	R		
HMK316 B7224□L-T				X7R 0.22 μ	±10, ±20	3.5	200	1.6±0.20	R		
HMK316 B7334□L-T				X7R 0.33 μ	±10, ±20	3.5	200	1.6±0.20	R		
HMK316 B7474□L-T				X7R 0.47 μ	±10, ±20	3.5	200	1.6±0.20	R		
HMK316 B7105□L-T				X7R 1 μ	±10, ±20	3.5	200	1.6±0.20	R		
QMK316 B7333□L-T				250	Standard Type	X7R 0.033 μ	±10, ±20	2.5	150	1.6±0.20	R
QMK316 B7473□L-T						X7R 0.047 μ	±10, ±20	2.5	150	1.6±0.20	R
QMK316 B7683□L-T						X7R 0.068 μ	±10, ±20	2.5	150	1.6±0.20	R
QMK316 B7104□L-T						X7R 0.1 μ	±10, ±20	2.5	150	1.6±0.20	R
SMK316 B7153□L-T						X7R 0.015 μ	±10, ±20	2.5	120	1.6±0.20	R
SMK316 B7223□L-T						X7R 0.022 μ	±10, ±20	2.5	120	1.6±0.20	R
SMK316AB7333□L-T		630	Standard Type	X7R 0.033 μ	±10, ±20	2.5	120	1.6±0.20	R		
SMK316AB7473□L-T				X7R 0.047 μ	±10, ±20	2.5	120	1.6±0.20	R		

▶ This catalog contains the typical specification only due to the limitation of space. When you consider the purchase of our products, please check our product specification sheets. For details of each product (characteristics graph, reliability information, precautions for use, and so on), see our website (<http://www.ty-top.com/>).

[Temperature Characteristic B7 : X7R(-55~+125°C)] 1.15mm thickness (F)

Part number 1	Part number 2	Rated voltage [V]	Temperature characteristics		Capacitance [F]	Capacitance tolerance [%]	tan δ [%]	HTLT	Thickness*3 [mm]	Soldering R:Reflow W:Wave
								Rated voltage x %		
SMK316 B7102□F-T		630	X7R		1000 p	±10, ±20	2.5	120	1.15±0.10	R
SMK316 B7152□F-T			X7R		1500 p	±10, ±20	2.5	120	1.15±0.10	R
SMK316 B7222□F-T			X7R		2200 p	±10, ±20	2.5	120	1.15±0.10	R
SMK316 B7332□F-T			X7R		3300 p	±10, ±20	2.5	120	1.15±0.10	R
SMK316 B7472□F-T			X7R		4700 p	±10, ±20	2.5	120	1.15±0.10	R
SMK316 B7682□F-T			X7R		6800 p	±10, ±20	2.5	120	1.15±0.10	R
SMK316 B7103□F-T			X7R		0.01 μ	±10, ±20	2.5	120	1.15±0.10	R

[Temperature Characteristic SD : Standard(-55~+125°C)] 1.6mm thickness (L)

Part number 1	Part number 2	Rated voltage [V]	Temperature characteristics		Capacitance [F]	Capacitance tolerance [%]	tan δ [%]	HTLT	Thickness*3 [mm]	Soldering R:Reflow W:Wave
								Rated voltage x %		
HMK316 SD223KL-T		100	Standard Type		0.022 μ	±10	0.1	200	1.6±0.20	R
QMK316 SD103KL-T		250			0.01 μ	±10	0.1	150	1.6±0.20	R

● 325TYPE

[Temperature Characteristic BJ : B(-25~+85°C)/X5R(-55~+85°C)] 2.5mm thickness (M)

Part number 1	Part number 2	Rated voltage [V]	Temperature characteristics		Capacitance [F]	Capacitance tolerance [%]	tan δ [%]	HTLT	Thickness*3 [mm]	Soldering R:Reflow W:Wave
								Rated voltage x %		
HMK325 BJ225□M-P		100	B	X5R ⁺	2.2 μ	±10, ±20	3.5	200	2.5±0.20	R
HMK325 BJ475□M-PE		100	B	X5R ⁺	4.7 μ	±10, ±20	3.5	150	2.5±0.20	R

[Temperature Characteristic BJ : B(-25~+85°C)/X5R(-55~+85°C)] 1.9mm thickness (N)

Part number 1	Part number 2	Rated voltage [V]	Temperature characteristics		Capacitance [F]	Capacitance tolerance [%]	tan δ [%]	HTLT	Thickness*3 [mm]	Soldering R:Reflow W:Wave
								Rated voltage x %		
HMK325 BJ154□N-T		100	B	X5R ⁺	0.15 μ	±10, ±20	3.5	200	1.9±0.20	R
HMK325 BJ224□N-T			B	X5R ⁺	0.22 μ	±10, ±20	3.5	200	1.9±0.20	R
HMK325 BJ334□N-T			B	X5R ⁺	0.33 μ	±10, ±20	3.5	200	1.9±0.20	R
HMK325 BJ474□N-T			B	X5R ⁺	0.47 μ	±10, ±20	3.5	200	1.9±0.20	R
HMK325 BJ684□N-T			B	X5R ⁺	0.68 μ	±10, ±20	3.5	200	1.9±0.20	R
HMK325 BJ105□N-T			B	X5R ⁺	1 μ	±10, ±20	3.5	200	1.9±0.20	R
HMK325 BJ475□N-TE			B	X5R ⁺	4.7 μ	±10, ±20	3.5	150	1.9±0.20	R
QMK325 BJ473□N-T		250	B	X5R ⁺	0.047 μ	±10, ±20	2.5	150	1.9±0.20	R
QMK325 BJ104□N-T			B	X5R ⁺	0.1 μ	±10, ±20	2.5	150	1.9±0.20	R
QMK325 BJ154□N-T			B	X5R ⁺	0.15 μ	±10, ±20	2.5	150	1.9±0.20	R
QMK325 BJ224□N-T			B	X5R ⁺	0.22 μ	±10, ±20	2.5	150	1.9±0.20	R
SMK325 BJ223□N-T			B	X5R ⁺	0.022 μ	±10, ±20	2.5	120	1.9±0.20	R
SMK325 BJ333□N-T			B	X5R ⁺	0.033 μ	±10, ±20	2.5	120	1.9±0.20	R
SMK325 BJ473□N-T			B	X5R ⁺	0.047 μ	±10, ±20	2.5	120	1.9±0.20	R

[Temperature Characteristic BJ : B(-25~+85°C)/X5R(-55~+85°C)] 1.15mm thickness (F)

Part number 1	Part number 2	Rated voltage [V]	Temperature characteristics		Capacitance [F]	Capacitance tolerance [%]	tan δ [%]	HTLT	Thickness*3 [mm]	Soldering R:Reflow W:Wave
								Rated voltage x %		
HMK325 BJ104□F-T		100	B	X5R ⁺	0.1 μ	±10, ±20	3.5	200	1.15±0.10	R

[Temperature Characteristic B7 : X7R(-55~+125°C)] 2.5mm thickness (M)

Part number 1	Part number 2	Rated voltage [V]	Temperature characteristics		Capacitance [F]	Capacitance tolerance [%]	tan δ [%]	HTLT	Thickness*3 [mm]	Soldering R:Reflow W:Wave
								Rated voltage x %		
HMK325 B7225□M-P		100	X7R		2.2 μ	±10, ±20	3.5	200	2.5±0.20	R

[Temperature Characteristic B7 : X7R(-55~+125°C)] 1.9mm thickness (N)

Part number 1	Part number 2	Rated voltage [V]	Temperature characteristics		Capacitance [F]	Capacitance tolerance [%]	tan δ [%]	HTLT	Thickness*3 [mm]	Soldering R:Reflow W:Wave
								Rated voltage x %		
HMK325 B7154□N-T		100	X7R		0.15 μ	±10, ±20	3.5	200	1.9±0.20	R
HMK325 B7224□N-T			X7R		0.22 μ	±10, ±20	3.5	200	1.9±0.20	R
HMK325 B7334□N-T			X7R		0.33 μ	±10, ±20	3.5	200	1.9±0.20	R
HMK325 B7474□N-T			X7R		0.47 μ	±10, ±20	3.5	200	1.9±0.20	R
HMK325 B7684□N-T			X7R		0.68 μ	±10, ±20	3.5	200	1.9±0.20	R
HMK325 B7105□N-T			X7R		1 μ	±10, ±20	3.5	200	1.9±0.20	R
QMK325 B7473□N-T			X7R		0.047 μ	±10, ±20	2.5	150	1.9±0.20	R
QMK325 B7104□N-T		250	X7R		0.1 μ	±10, ±20	2.5	150	1.9±0.20	R
QMK325 B7154□N-T			X7R		0.15 μ	±10, ±20	2.5	150	1.9±0.20	R
QMK325 B7224□N-T			X7R		0.22 μ	±10, ±20	2.5	150	1.9±0.20	R
SMK325 B7223□N-T			X7R		0.022 μ	±10, ±20	2.5	120	1.9±0.20	R
SMK325 B7333□N-T			X7R		0.033 μ	±10, ±20	2.5	120	1.9±0.20	R
SMK325 B7473□N-T			X7R		0.047 μ	±10, ±20	2.5	120	1.9±0.20	R

[Temperature Characteristic C7 : X7S(-55~+125°C)] 2.5mm thickness (M)

Part number 1	Part number 2	Rated voltage [V]	Temperature characteristics		Capacitance [F]	Capacitance tolerance [%]	tan δ [%]	HTLT	Thickness*3 [mm]	Soldering R:Reflow W:Wave
								Rated voltage x %		
HMK325 C7475□M-PE		100	X7S		4.7 μ	±10, ±20	3.5	150	2.5±0.20	R

[Temperature Characteristic C7 : X7S(-55~+125°C)] 1.9mm thickness (N)

Part number 1	Part number 2	Rated voltage [V]	Temperature characteristics		Capacitance [F]	Capacitance tolerance [%]	tan δ [%]	HTLT	Thickness*3 [mm]	Soldering R:Reflow W:Wave
								Rated voltage x %		
HMK325 C7475□N-TE		100	X7S		4.7 μ	±10, ±20	3.5	150	1.9±0.20	R

▶ This catalog contains the typical specification only due to the limitation of space. When you consider the purchase of our products, please check our product specification sheets. For details of each product (characteristics graph, reliability information, precautions for use, and so on), see our website (<http://www.ty-top.com/>).

PARTS NUMBER

【Temperature Characteristic B7 : X7R(-55~+125°C)】 1.15mm thickness(F)

Part number 1	Part number 2	Rated voltage [V]	Temperature characteristics	Capacitance [F]	Capacitance tolerance [%]	tan δ [%]	HTLT	Thickness*3 [mm]	Soldering R:Reflow W:Wave
							Rated voltage x %		
HMK325 B7104□F-T		100	X7R	0.1 μ	±10, ±20	3.5	200	1.15±0.10	R

● 432TYPE

【Temperature Characteristic BJ : B(-25~+85°C)/X5R(-55~+85°C)】 2.5mm thickness(M)

Part number 1	Part number 2	Rated voltage [V]	Temperature characteristics	Capacitance [F]	Capacitance tolerance [%]	tan δ [%]	HTLT	Thickness*3 [mm]	Soldering R:Reflow W:Wave
							Rated voltage x %		
HMK432 BJ474□M-T		100	B X5R ⁺¹	0.47 μ	±10, ±20	3.5	200	2.5±0.20	R
HMK432 BJ105□M-T			B X5R ⁺¹	1 μ	±10, ±20	3.5	200	2.5±0.20	R
HMK432 BJ155□M-T			B X5R ⁺¹	1.5 μ	±10, ±20	3.5	200	2.5±0.20	R
HMK432 BJ225□M-T			B X5R ⁺¹	2.2 μ	±10, ±20	3.5	200	2.5±0.20	R
QMK432 BJ104□M-T		250	B X5R ⁺¹	0.1 μ	±10, ±20	2.5	150	2.5±0.20	R
QMK432 BJ224□M-T			B X5R ⁺¹	0.22 μ	±10, ±20	2.5	150	2.5±0.20	R
QMK432 BJ334□M-T			B X5R ⁺¹	0.33 μ	±10, ±20	2.5	150	2.5±0.20	R
QMK432 BJ474□M-T			B X5R ⁺¹	0.47 μ	±10, ±20	2.5	150	2.5±0.20	R
SMK432 BJ473□M-T		630	B X5R ⁺¹	0.047 μ	±10, ±20	2.5	120	2.5±0.20	R
SMK432 BJ683□M-T			B X5R ⁺¹	0.068 μ	±10, ±20	2.5	120	2.5±0.20	R
SMK432 BJ104□M-T			B X5R ⁺¹	0.1 μ	±10, ±20	2.5	120	2.5±0.20	R

【Temperature Characteristic B7 : X7R(-55~+125°C)】 2.5mm thickness(M)

Part number 1	Part number 2	Rated voltage [V]	Temperature characteristics	Capacitance [F]	Capacitance tolerance [%]	tan δ [%]	HTLT	Thickness*3 [mm]	Soldering R:Reflow W:Wave
							Rated voltage x %		
HMK432 B7474□M-T		100	X7R	0.47 μ	±10, ±20	3.5	200	2.5±0.20	R
HMK432 B7105□M-T			X7R	1 μ	±10, ±20	3.5	200	2.5±0.20	R
HMK432 B7155□M-T			X7R	1.5 μ	±10, ±20	3.5	200	2.5±0.20	R
HMK432 B7225□M-T			X7R	2.2 μ	±10, ±20	3.5	200	2.5±0.20	R
QMK432 B7104□M-T		250	X7R	0.1 μ	±10, ±20	2.5	150	2.5±0.20	R
QMK432 B7224□M-T			X7R	0.22 μ	±10, ±20	2.5	150	2.5±0.20	R
QMK432 B7334□M-T			X7R	0.33 μ	±10, ±20	2.5	150	2.5±0.20	R
QMK432 B7474□M-T			X7R	0.47 μ	±10, ±20	2.5	150	2.5±0.20	R
SMK432 B7473□M-T		630	X7R	0.047 μ	±10, ±20	2.5	120	2.5±0.20	R
SMK432 B7683□M-T			X7R	0.068 μ	±10, ±20	2.5	120	2.5±0.20	R
SMK432 B7104□M-T			X7R	0.1 μ	±10, ±20	2.5	120	2.5±0.20	R

【Temperature Characteristic B7 : X7R(-55~+125°C)】 2.0mm thickness(Y)

Part number 1	Part number 2	Rated voltage [V]	Temperature characteristics	Capacitance [F]	Capacitance tolerance [%]	tan δ [%]	HTLT	Thickness*3 [mm]	Soldering R:Reflow W:Wave
							Rated voltage x %		
XMK432 B7222KY-TE		2000	X7R	2200 p	±10	2.5	110	2.0+0/-0.30	R
XMK432 B7472KY-TE		2000	X7R	4700 p	±10	2.5	110	2.0+0/-0.30	R

► This catalog contains the typical specification only due to the limitation of space. When you consider the purchase of our products, please check our product specification sheets. For details of each product (characteristics graph, reliability information, precautions for use, and so on), see our website (<http://www.ty-top.com/>).

Multilayer Ceramic Capacitors

PACKAGING

① Minimum Quantity

● Taped package

Type(EIA)	Thickness		Standard quantity [pcs]	
	mm	code	Paper tape	Embossed tape
□MK021(008004)	0.125	K	—	50000
□VS021(008004)				
□MK042(01005)	0.2	C, D	—	40000
□VS042(01005)				
□MK063(0201)	0.3	P, T	15000	—
□WK105(0204) ※	0.3	P	10000	—
□MK105(0402) □MF105(0402)	0.13	H	—	20000
	0.18	E	—	15000
	0.2	C	20000	—
	0.3	P	15000	—
	0.5	V	10000	—
□VK105(0402)	0.5	W	10000	—
□MK107(0603)	0.45	K	4000	—
□WK107(0306) ※				
□MF107(0603)	0.5	V	—	4000
□VS107(0603)	0.8	A	4000	—
□MJ107(0603)	0.7	C	4000	—
□MJ107(0603)	0.8	A	3000	3000
□MK212(0805)	0.45	K	4000	—
□WK212(0508) ※				
□MF212(0805)	0.85	D	—	3000
□VS212(0805)	1.25	G	—	3000
□MJ212(0805)	0.85	D	4000	—
	1.25	G	—	2000
□MK316(1206) □MF316(1206)	0.85	D	4000	—
	1.15	F	—	3000
□MJ316(1206)	1.6	L	—	2000
	1.15	F	—	3000
□MK325(1210) □MF325(1210)	1.6	L	—	2000
	0.85	D	—	2000
	1.15	F		
	1.9	N		
2.0max.	Y			
□MJ325(1210)	2.5	M	—	1000
	1.9	N	—	2000
□MK432(1812)	2.5	M	—	500(T), 1000(P)
	2.5	M	—	500

Note : ※ LW Reverse type.

② Taping material

※No bottom tape for pressed carrier tape

● Card board carrier tape

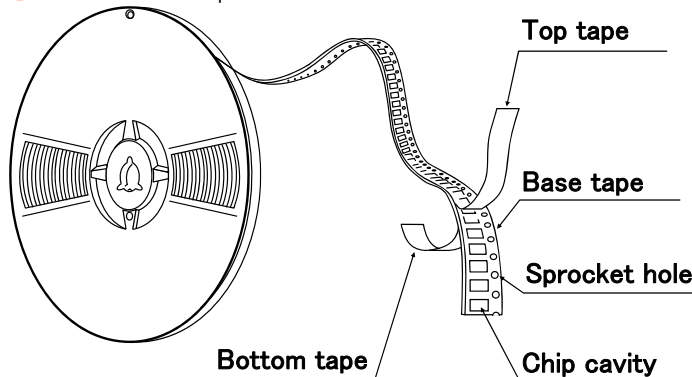

● Embossed tape

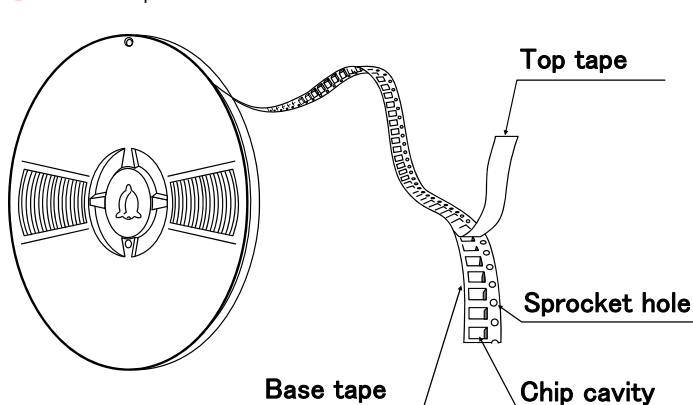

▶ This catalog contains the typical specification only due to the limitation of space. When you consider the purchase of our products, please check our specification. For details of each product (characteristics graph, reliability information, precautions for use, and so on), see our Web site (<http://www.ty-top.com/>).

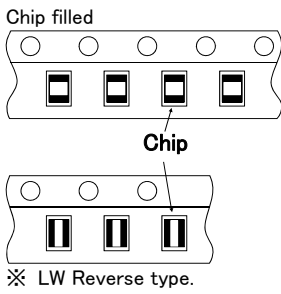

③ Representative taping dimensions

● Paper Tape (8mm wide)

● Pressed carrier tape (2mm pitch)

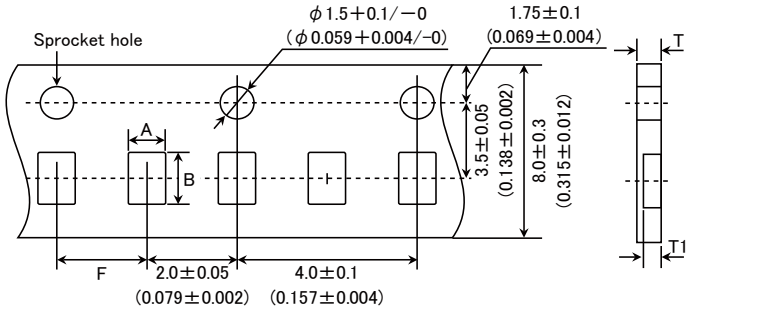

Type(EIA)	Chip Cavity		Insertion Pitch F	Tape Thickness	
	A	B		T	T1
□MK063(0201)	0.37	0.67	2.0±0.05	0.45max.	0.42max.
□WK105(0204) ※	0.65	1.15		0.4max.	0.3max.
□MK105(0402) (*1 C)				0.45max.	0.42max.
□MK105(0402) (*1 P)					

Note *1 Thickness, C:0.2mm ,P:0.3mm. ※ LW Reverse type.

Unit: mm

● Punched carrier tape (2mm pitch)

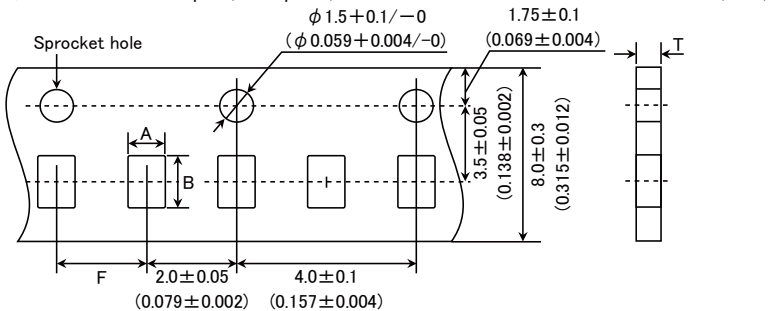

Type(EIA)	Chip Cavity		Insertion Pitch F	Tape Thickness T
	A	B		
□MK105 (0402)	0.65	1.15	2.0±0.05	0.8max.
□MF105 (0402)				
□VK105 (0402)				

Unit: mm

● Punched carrier tape (4mm pitch)

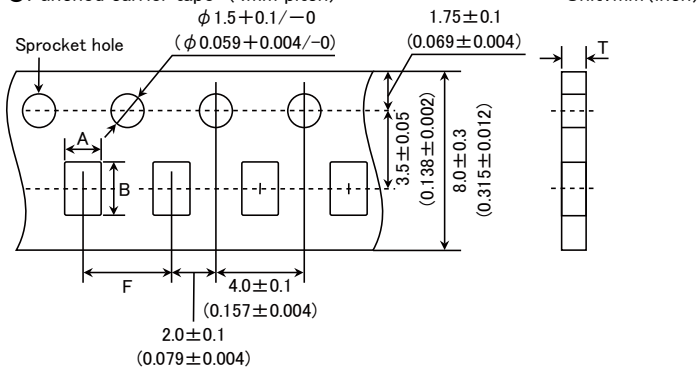

▶ This catalog contains the typical specification only due to the limitation of space. When you consider the purchase of our products, please check our specification. For details of each product (characteristics graph, reliability information, precautions for use, and so on), see our Web site (<http://www.ty-top.com/>).

Type(EIA)	Chip Cavity		Insertion Pitch	Tape Thickness	
	A	B		F	T
□MK107(0603) □WK107(0306) ※ □MF107(0603)	1.0	1.8	4.0±0.1	1.1max.	
□MK212(0805) □WK212(0508) ※ □MK316(1206)				1.65	2.4
	2.0	3.6			

Note: Taping size might be different depending on the size of the product. ※ LW Reverse type.

Unit: mm

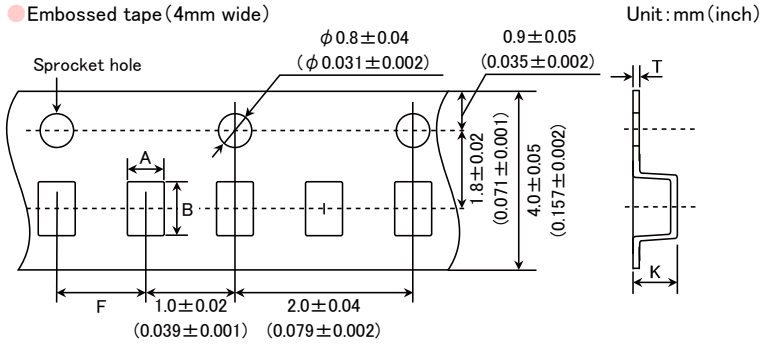

Type(EIA)	Chip Cavity		Insertion Pitch	Tape Thickness			
	A	B		F	K	T	
□MK021(008004) □VS021(008004)	0.135	0.27	1.0±0.02	0.5max.	0.25max.		
□MK042(01005) □VS042(01005)						0.23	0.43

Unit: mm

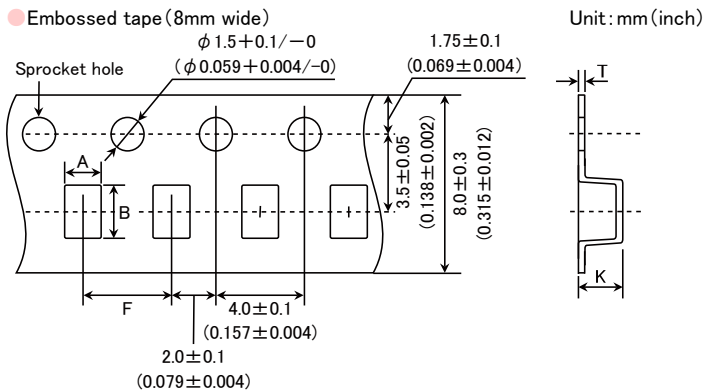

Type(EIA)	Chip Cavity		Insertion Pitch	Tape Thickness	
	A	B		F	K
□MK105(0402) □WK107(0306) ※ □MK212(0805) □MF212(0805)	0.6	1.1	2.0±0.1	0.6max.	0.2±0.1
□MK316(1206) □MF316(1206)	2.0	3.6		4.0±0.1	1.3max.
□MK325(1210) □MF325(1210)	2.8	3.6	3.4max.		0.6max.

Note: ※ LW Reverse type.

Unit: mm

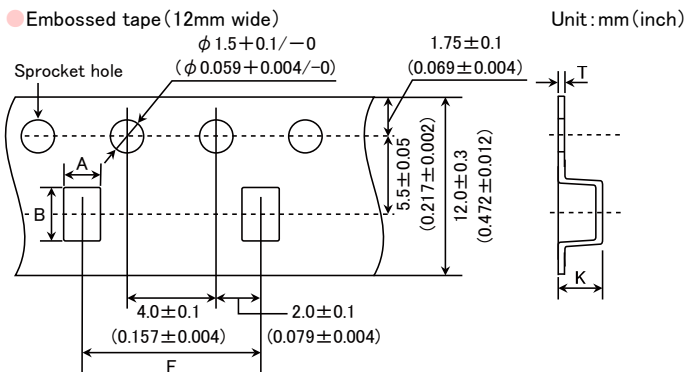

Type(EIA)	Chip Cavity		Insertion Pitch F	Tape Thickness	
	A	B		K	T
□MK325(1210)	3.1	4.0	8.0±0.1	4.0max.	0.6max.
□MK432(1812)	3.7	4.9	8.0±0.1	4.0max.	0.6max.

Unit: mm

④Trailer and Leader

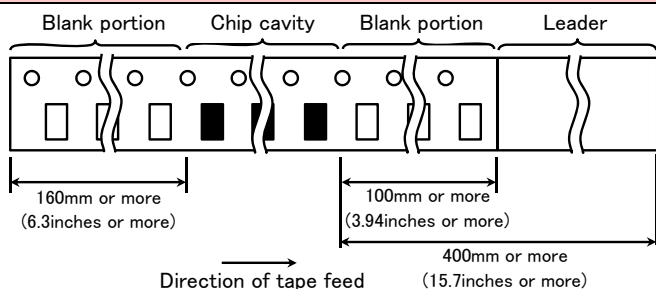

⑤Reel size

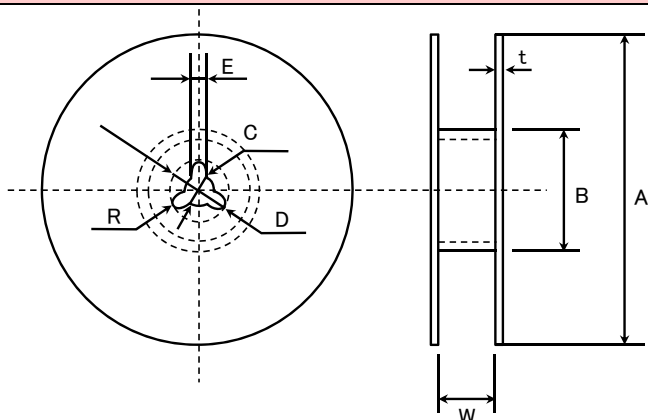

A	B	C	D	E	R
$\phi 178 \pm 2.0$	$\phi 50 \text{ min.}$	$\phi 13.0 \pm 0.2$	$\phi 21.0 \pm 0.8$	2.0 ± 0.5	1.0

	T	W
4mm wide tape	1.5max.	5 ± 1.0
8mm wide tape	2.5max.	10 ± 1.5
12mm wide tape	2.5max.	14 ± 1.5

Unit: mm

⑥Top Tape Strength

The top tape requires a peel-off force of 0.1 to 0.7N in the direction of the arrow as illustrated below.

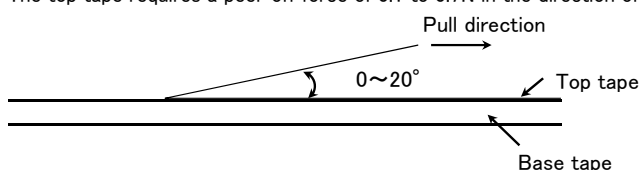

▶ This catalog contains the typical specification only due to the limitation of space. When you consider the purchase of our products, please check our specification. For details of each product (characteristics graph, reliability information, precautions for use, and so on), see our Web site (<http://www.ty-top.com/>).

Medium-High Voltage Multilayer Ceramic Capacitor

RELIABILITY DATA

1. Operating Temperature Range		
Specified Value	Temperature Compensating(Class1)	CG : -55 to +125°C
	High Permittivity (Class2)	X7R, X7S : -55 to +125°C X5R : -55 to +85°C B : -25 to +85°C SD : -55 to +125°C
2. Storage Temperature Range		
Specified Value	Temperature Compensating(Class1)	CG : -55 to +125°C
	High Permittivity (Class2)	X7R, X7S : -55 to +125°C X5R : -55 to +85°C B : -25 to +85°C SD : -55 to +125°C
3. Rated Voltage		
Specified Value	Temperature Compensating(Class1)	100VDC(HMK)
	High Permittivity (Class2)	100VDC(HMK), 250VDC(QMK), 630VDC(SMK), 2000VDC(XMK)
4. Withstanding Voltage (Between terminals)		
Specified Value	No breakdown or damage	
Test Methods and Remarks	Applied voltage : Rated voltage × 2.5 (HMK), Rated voltage × 2 (QMK), Rated voltage × 1.2 (SMK) (XMK) Duration : 1 to 5sec. Charge/discharge current : 50mA max.	
5. Insulation Resistance		
Specified Value	Temperature Compensating(Class1)	10000 MΩ min.
	High Permittivity (Class2)	100MΩ · μF or 10GΩ, whichever is smaller.
Test Methods and Remarks	Applied voltage : Rated voltage (HMK, QMK), 500V (SMK, XMK) Duration : 60 ± 5sec. Charge/discharge current : 50mA max.	
6. Capacitance (Tolerance)		
Specified Value	Temperature Compensating(Class1)	0.2pF ≤ C ≤ 5pF : ±0.25pF 0.2pF ≤ C ≤ 10pF : ±0.5pF C > 10pF : ±5% or ±10%
	High Permittivity (Class2)	±10%, ±20%
Test Methods and Remarks	Temperature Compensating(Class1)	Measuring frequency : 1MHz ± 10% Measuring voltage : 0.5 ~ 5Vrms Bias application : None
	High Permittivity (Class2)	Measuring frequency : 1kHz ± 10% Measuring voltage : 1 ± 0.2Vrms Bias application : None
7. Q or Dissipation Factor		
Specified Value	Temperature Compensating(Class1)	C < 30pF : Q ≥ 400 + 20C C ≥ 30pF : Q ≥ 1000 (C: Nominal capacitance)
	High Permittivity (Class2)	3.5%max (HMK), 2.5%max (QMK, SMK)
Test Methods and Remarks	Temperature Compensating(Class1)	Measuring frequency : 1MHz ± 10% Measuring voltage : 0.5 ~ 5Vrms Bias application : None
	High Permittivity (Class2)	Measuring frequency : 1kHz ± 10% Measuring voltage : 1 ± 0.2Vrms Bias application : None

▶ This catalog contains the typical specification only due to the limitation of space. When you consider the purchase of our products, please check our specification. For details of each product (characteristics graph, reliability information, precautions for use, and so on), see our Web site (<http://www.ty-top.com/>).

8. Temperature Characteristic of Capacitance

Specified Value	Temperature Compensating(Class1)	CG : $0 \pm 30 \text{ ppm}/^\circ\text{C} (-55 \text{ to } +125^\circ\text{C})$												
	High Permittivity (Class2)	B : $\pm 10\% (-25 \text{ to } +85^\circ\text{C})$ X5R : $\pm 15\% (-55 \text{ to } +85^\circ\text{C})$ X7R : $\pm 15\% (-55 \text{ to } +125^\circ\text{C})$ X7S : $\pm 22\% (-55 \text{ to } +125^\circ\text{C})$ SD : - ($-55 \text{ to } +125^\circ\text{C}$)												
Test Methods and Remarks	Class 1 Capacitance at 20°C and 85°C shall be measured in thermal equilibrium, and the temperature characteristic shall be calculated from the following equation. $\frac{(C_{85} - C_{20})}{C_{20} \times \Delta T} \times 10^6 (\text{ppm}/^\circ\text{C}) \quad \Delta T = 65$													
	Class 2 Capacitance at each step shall be measured in thermal equilibrium, and the temperature characteristic shall be calculated from the following equation.													
	<table border="1"> <thead> <tr> <th>Step</th> <th>B</th> <th>X5R, X7R, X6S, X7S</th> </tr> </thead> <tbody> <tr> <td>1</td> <td colspan="2">Minimum operating temperature</td> </tr> <tr> <td>2</td> <td>20°C</td> <td>25°C</td> </tr> <tr> <td>3</td> <td colspan="2">Maximum operating temperature</td> </tr> </tbody> </table>		Step	B	X5R, X7R, X6S, X7S	1	Minimum operating temperature		2	20°C	25°C	3	Maximum operating temperature	
	Step	B	X5R, X7R, X6S, X7S											
1	Minimum operating temperature													
2	20°C	25°C												
3	Maximum operating temperature													
$\frac{(C - C_2)}{C_2} \times 100 (\%)$ C : Capacitance value in Step 1 or Step 3 C2 : Capacitance value in Step 2														

9. Deflection

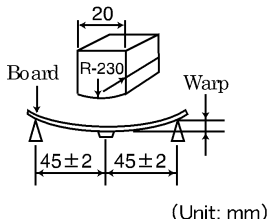
Specified Value	Temperature Compensating(Class1)	Appearance : No abnormality Capacitance change : Within $\pm 5\%$ or $\pm 0.5 \text{ pF}$, whichever is larger.
	High Permittivity (Class2)	Appearance : No abnormality Capacitance change : Within $\pm 10\%$
Test Methods and Remarks	Warp : 1mm Duration : 10sec. Test board : Glass epoxy-resin substrate Thickness : 1.6mm	
	 <p>(Unit: mm)</p> <p>Capacitance measurement shall be conducted with the board bent.</p>	

10. Adhesive Strength of Terminal Electrodes

Specified Value	Temperature Compensating(Class1)	No terminal separation or its indication.
	High Permittivity (Class2)	
Test Methods and Remarks	Applied force : 5N	
	Duration : $30 \pm 5 \text{ sec.}$	

11. Solderability

Specified Value	Temperature Compensating(Class1)	At least 95% of terminal electrode is covered by new solder	
	High Permittivity (Class2)		
Test Methods and Remarks		Eutectic solder	Lead-free solder
	Solder type	H60A or H63A	Sn-3.0Ag-0.5Cu
	Solder temperature	$230 \pm 5^\circ\text{C}$	$245 \pm 3^\circ\text{C}$
	Duration	$4 \pm 1 \text{ sec.}$	

12. Resistance to Soldering

Specified Value	Temperature Compensating(Class1)	Appearance : No abnormality Capacitance change : Within $\pm 2.5\%$ or $\pm 0.25\text{pF}$, whichever is larger.(HMK) Q : Initial value Insulation resistance : Initial value Withstanding voltage (between terminals) : No abnormality
	High Permittivity (Class2)	Appearance : No abnormality Capacitance change : Within $\pm 15\%$ (HMK), $\pm 10\%$ (QMK, SMK, XMK) Dissipation facto : Initial value Insulation resistance : Initial value Withstanding voltage (between terminals) : No abnormality
Test Methods and Remarks	Temperature Compensating(Class1)	
	Preconditioning	None
	Solder temperature	$270 \pm 5^\circ\text{C}$
	Duration	$3 \pm 0.5\text{sec.}$
	Preheating conditions	80 to 100°C , 2 to 5 min. 150 to 200°C , 2 to 5min.
	Recovery	$24 \pm 2\text{hrs}$ under the standard condition Note3
	High Permittivity (Class2)	
	Preconditioning	Thermal treatment(at 150°C for 1hr) Note1
	Solder temperature	$270 \pm 5^\circ\text{C}$
	Duration	$3 \pm 0.5\text{sec.}$
	Preheating conditions	80 to 100°C , 2 to 5 min. 150 to 200°C , 2 to 5min.
	Recovery	$24 \pm 2\text{hrs}$ under the standard condition Note3

13. Temperature Cycle (Thermal Shock)

Specified Value	Temperature Compensating(Class1)	Appearance : No abnormality Capacitance change : Within $\pm 2.5\%$ or $\pm 0.25\text{pF}$, whichever is larger.(HMK) Q : Initial value Insulation resistance : Initial value Withstanding voltage (between terminals) : No abnormality	
	High Permittivity (Class2)	Appearance : No abnormality Capacitance change : Within $\pm 15\%$ (HMK), $\pm 10\%$ (QMK, SMK, XMK) Dissipation facto : Initial value Insulation resistance : Initial value Withstanding voltage (between terminals) : No abnormality	
Test Methods and Remarks	Class 1		
	Preconditioning	None	
	1 cycle	Step	Temperature ($^\circ\text{C}$)
		1	Minimum operating temperature
		2	Normal temperature
		3	Maximum operating temperature
	4	Normal temperature	
Number of cycles	5 times		
Recovery	6 to 24 hrs (Standard condition) Note 3	24 ± 2 hrs (Standard condition) Note 3	

14. Humidity (Steady state)

Specified Value	Temperature Compensating(Class1)	Appearance : No abnormality Capacitance change : Within $\pm 5\%$ or $\pm 0.5\text{pF}$, whichever is larger.(HMK) Q : $C < 10\text{pF}$: $Q \geq 200 + 10C$ $10 \leq C < 30\text{pF}$: $Q \geq 275 + 2.5C$ $C \geq 30\text{pF}$: $Q \geq 350$ (C: Nominal capacitance) Insulation resistance : $1000 \text{ M}\Omega$ min.
	High Permittivity (Class2)	Appearance : No abnormality Capacitance change : Within $\pm 15\%$ Dissipation factor : $7\%\text{max}$ (HMK), $5\%\text{max}$ (QMK, SMK, XMK). Insulation resistance : $25 \text{ M}\Omega$ μF or $1000 \text{ M}\Omega$, whichever is smaller.
Test Methods and Remarks	Class 1	
	Preconditioning	None
	Temperature	$40 \pm 2^\circ\text{C}$
	Humidity	90 to 95%RH
	Duration	$500 + 24 / - 0$ hrs
	Recovery	6 to 24 hrs (Standard condition) Note 3
Class 2		
Preconditioning	Thermal treatment(at 150°C for 1 hr) Note 1	
Temperature	$40 \pm 2^\circ\text{C}$	
Humidity	90 to 95%RH	
Duration	$500 + 24 / - 0$ hrs	
Recovery	24 ± 2 hrs (Standard condition) Note 3	

▶ This catalog contains the typical specification only due to the limitation of space. When you consider the purchase of our products, please check our specification. For details of each product (characteristics graph, reliability information, precautions for use, and so on), see our Web site (<http://www.ty-top.com/>).

15. Humidity Loading

Specified Value	Temperature Compensating(Class1)	Appearance : No abnormality Capacitance change : Within $\pm 7.5\%$ or $\pm 0.75\text{pF}$, whichever is larger (HMK). Q : $C < 30\text{pF} : Q \geq 100 + 10C/3$ $C \geq 30\text{pF} : Q \geq 200$ (C: Nominal capacitance) Insulation resistance : 500 M Ω min.	
	High Permittivity (Class2)	Appearance : No abnormality Capacitance change : Within $\pm 15\%$ Dissipation factor : 7%max (HMK), 5%max (QMK, SMK, XMK). Insulation resistance : 10M Ω μ F or 500M Ω , whichever is smaller.	
Test Methods and Remarks	According to JIS 5101-1.		
		Class 1	Class 2
	Preconditioning	None	Voltage treatment (Rated voltage are applied for 1 hour at 40°C) Note 2
	Temperature	40 \pm 2°C	40 \pm 2°C
	Humidity	90 to 95%RH	90 to 95%RH
	Duration	500 + 24 / - 0 hrs	500 + 24 / - 0 hrs
	Applied voltage	Rated voltage	Rated voltage
	Charge/discharge current	50mA max.	50mA max.
Recovery	6 to 24 hrs (Standard condition) Note 3	24 \pm 2 hrs (Standard condition) Note 3	

16. High Temperature Loading

Specified Value	Temperature Compensating(Class1)	Appearance : No abnormality Capacitance change : Within $\pm 7.5\%$ or $\pm 0.75\text{pF}$, whichever is larger.(HMK) Q : $C < 30\text{pF} : Q \geq 100 + 10C/3$ $C \geq 30\text{pF} : Q \geq 200$ (C: Nominal capacitance) Insulation resistance : 500 M Ω min.	
	High Permittivity (Class2)	Appearance : No abnormality Capacitance change : Within $\pm 15\%$ Dissipation factor : 7%max (HMK), 5%max (QMK, SMK, XMK). Insulation resistance : 50M Ω μ F or 1000M Ω , whichever is smaller.	
Test Methods and Remarks	According to JIS 5101-1.		
		Class 1	Class 2
	Preconditioning	None	Voltage treatment Note 2
	Temperature	Maximum operating temperature	Maximum operating temperature
	Duration	1000 + 48 / - 0 hrs	1000 + 48 / - 0 hrs
	Applied voltage	Rated voltage \times 2(HMK)	Rated voltage \times 2(HMK), Rated voltage \times 1.5 (QMK), Rated voltage \times 1.2 (SMK, XMK)
	Charge/discharge current	50mA max.	50mA max.
	Recovery	6 to 24hr (Standard condition) Note 3	24 \pm 2 hrs (Standard condition) Note 3

Note1 Thermal treatment : Initial value shall be measured after test sample is heat-treated at 150 + 0 / - 10°C for an hour and kept at room temperature for 24 \pm 2hours.

Note2 Voltage treatment : Initial value shall be measured after test sample is voltage-treated for an hour at both the temperature and voltage specified in the test conditions, and kept at room temperature for 24 \pm 2hours.

Note3 Standard condition : Temperature: 5 to 35°C, Relative humidity: 45 to 85 % RH, Air pressure: 86 to 106kPa

When there are questions concerning measurement results, in order to provide correlation data, the test shall be conducted under the following condition.

Temperature: 20 \pm 2°C, Relative humidity: 60 to 70 % RH, Air pressure: 86 to 106kPa

Unless otherwise specified, all the tests are conducted under the "standard condition".

Precautions on the use of Multilayer Ceramic Capacitors

■ PRECAUTIONS

1. Circuit Design

- ◆ Verification of operating environment, electrical rating and performance**
1. A malfunction of equipment in fields such as medical, aerospace, nuclear control, etc. may cause serious harm to human life or have severe social ramifications.
Therefore, any capacitors to be used in such equipment may require higher safety and reliability, and shall be clearly differentiated from them used in general purpose applications.
- ◆ Operating Voltage (Verification of Rated voltage)**
1. The operating voltage for capacitors must always be their rated voltage or less.
If an AC voltage is loaded on a DC voltage, the sum of the two peak voltages shall be the rated voltage or less.
For a circuit where an AC or a pulse voltage may be used, the sum of their peak voltages shall also be the rated voltage or less.
 2. Even if an applied voltage is the rated voltage or less reliability of capacitors may be deteriorated in case that either a high frequency AC voltage or a pulse voltage having rapid rise time is used in a circuit.

2. PCB Design

- ◆ Pattern configurations (Design of Land-patterns)**
1. When capacitors are mounted on PCBs, the amount of solder used (size of fillet) can directly affect the capacitor performance.
Therefore, the following items must be carefully considered in the design of land patterns:
 - (1) Excessive solder applied can cause mechanical stresses which lead to chip breaking or cracking. Therefore, please consider appropriate land-patterns for proper amount of solder.
 - (2) When more than one component are jointly soldered onto the same land, each component's soldering point shall be separated by solder-resist.
- ◆ Pattern configurations (Capacitor layout on PCBs)**
- After capacitors are mounted on boards, they can be subjected to mechanical stresses in subsequent manufacturing processes (PCB cutting, board inspection, mounting of additional parts, assembly into the chassis, wave soldering of the boards, etc.). For this reason, land pattern configurations and positions of capacitors shall be carefully considered to minimize stresses.

◆ Pattern configurations (Design of Land-patterns)

The following diagrams and tables show some examples of recommended land patterns to prevent excessive solder amounts.

(1) Recommended land dimensions for typical chip capacitors

● Multilayer Ceramic Capacitors : Recommended land dimensions (unit: mm)

Wave-soldering

Type	107	212	316	325
Size	L	1.6	2.0	3.2
	W	0.8	1.25	1.6
A	0.8 to 1.0	1.0 to 1.4	1.8 to 2.5	1.8 to 2.5
B	0.5 to 0.8	0.8 to 1.5	0.8 to 1.7	0.8 to 1.7
C	0.6 to 0.8	0.9 to 1.2	1.2 to 1.6	1.8 to 2.5

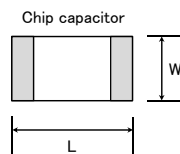
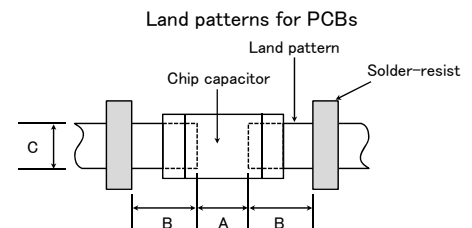

Reflow-soldering

Type	021	042	063	105	107	212	316	325	432
Size	L	0.25	0.4	0.6	1.0	1.6	2.0	3.2	4.5
	W	0.125	0.2	0.3	0.5	0.8	1.25	1.6	3.2
A	0.095~0.135	0.15~0.25	0.20~0.30	0.45~0.55	0.6~0.8	0.8~1.2	1.8~2.5	1.8~2.5	2.5~3.5
B	0.085~0.125	0.10~0.20	0.20~0.30	0.40~0.50	0.6~0.8	0.8~1.2	1.0~1.5	1.0~1.5	1.5~1.8
C	0.110~0.150	0.15~0.30	0.25~0.40	0.45~0.55	0.6~0.8	0.9~1.6	1.2~2.0	1.8~3.2	2.3~3.5

Note: Recommended land size might be different according to the allowance of the size of the product.

● LWDC: Recommended land dimensions for reflow-soldering (unit: mm)

Type	105	107	212
Size	L	0.52	0.8
	W	1.0	1.6
A	0.18~0.22	0.25~0.3	0.5~0.7
B	0.2~0.25	0.3~0.4	0.4~0.5
C	0.9~1.1	1.5~1.7	1.9~2.1

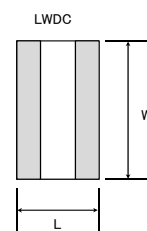

Technical considerations

(2) Examples of good and bad solder application

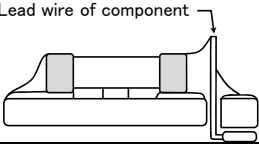
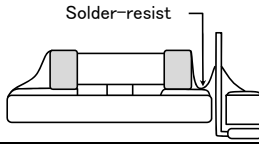
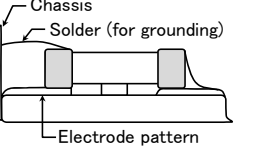
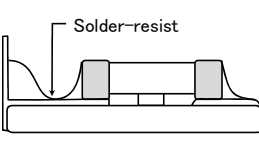
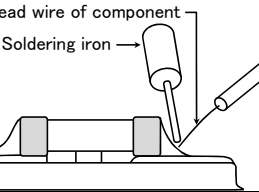
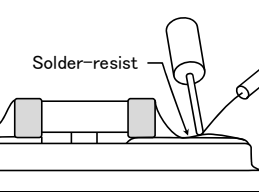
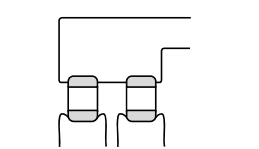
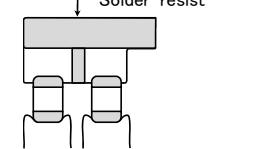
Item	Not recommended	Recommended
Mixed mounting of SMD and leaded components		
Component placement close to the chassis		
Hand-soldering of leaded components near mounted components		
Horizontal component placement		

◆ Pattern configurations (Capacitor layout on PCBs)

1-1. The following is examples of good and bad capacitor layouts ; capacitors shall be located to minimize any possible mechanical stresses from board warp or deflection.

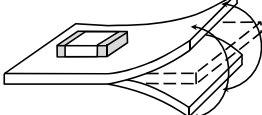
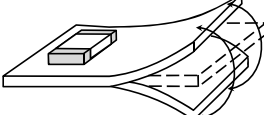
Items	Not recommended	Recommended
Deflection of board		 Place the product at a right angle to the direction of the anticipated mechanical stress.

1-2. The amount of mechanical stresses given will vary depending on capacitor layout. Please refer to diagram below.

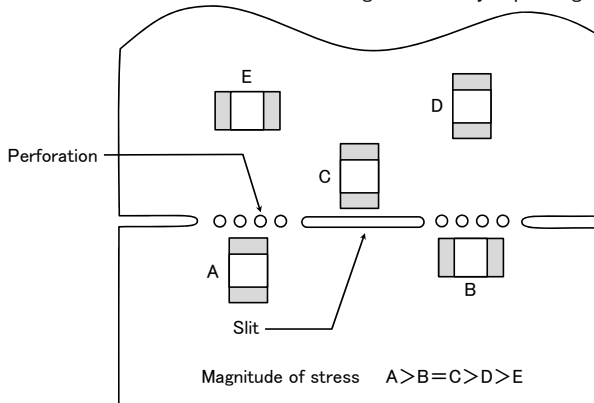

1-3. When PCB is split, the amount of mechanical stress on the capacitors can vary according to the method used. The following methods are listed in order from least stressful to most stressful: push-back, slit, V-grooving, and perforation. Thus, please consider the PCB, split methods as well as chip location.

3. Mounting

Precautions

◆ Adjustment of mounting machine

- When capacitors are mounted on PCB, excessive impact load shall not be imposed on them.
- Maintenance and inspection of mounting machines shall be conducted periodically.

◆ Selection of Adhesives

- When chips are attached on PCBs with adhesives prior to soldering, it may cause capacitor characteristics degradation unless the following factors are appropriately checked : size of land patterns, type of adhesive, amount applied, hardening temperature and hardening period. Therefore, please contact us for further information.

◆ Adjustment of mounting machine

1. When the bottom dead center of a pick-up nozzle is too low, excessive force is imposed on capacitors and causes damages. To avoid this, the following points shall be considerable.

- (1) The bottom dead center of the pick-up nozzle shall be adjusted to the surface level of PCB without the board deflection.
- (2) The pressure of nozzle shall be adjusted between 1 and 3 N static loads.
- (3) To reduce the amount of deflection of the board caused by impact of the pick-up nozzle, supporting pins or back-up pins shall be used on the other side of the PCB. The following diagrams show some typical examples of good and bad pick-up nozzle placement:

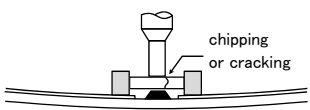
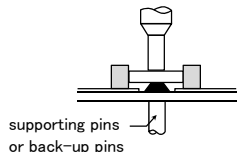
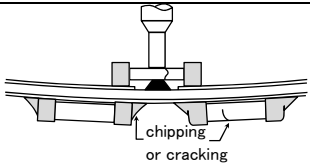
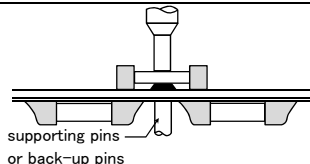
Item	Improper method	Proper method
Single-sided mounting		
Double-sided mounting		

Technical considerations

2. As the alignment pin is worn out, adjustment of the nozzle height can cause chipping or cracking of capacitors because of mechanical impact on the capacitors.

To avoid this, the monitoring of the width between the alignment pins in the stopped position, maintenance, check and replacement of the pin shall be conducted periodically.

◆ Selection of Adhesives

Some adhesives may cause IR deterioration. The different shrinkage percentage of between the adhesive and the capacitors may result in stresses on the capacitors and lead to cracking. Moreover, too little or too much adhesive applied to the board may adversely affect components. Therefore, the following precautions shall be noted in the application of adhesives.

(1) Required adhesive characteristics

- a. The adhesive shall be strong enough to hold parts on the board during the mounting & solder process.
- b. The adhesive shall have sufficient strength at high temperatures.
- c. The adhesive shall have good coating and thickness consistency.
- d. The adhesive shall be used during its prescribed shelf life.
- e. The adhesive shall harden rapidly.
- f. The adhesive shall have corrosion resistance.
- g. The adhesive shall have excellent insulation characteristics.
- h. The adhesive shall have no emission of toxic gasses and no effect on the human body.

(2) The recommended amount of adhesives is as follows;

[Recommended condition]

Figure	212/316 case sizes as examples
a	0.3mm min
b	100 to 120 μm
c	Adhesives shall not contact land

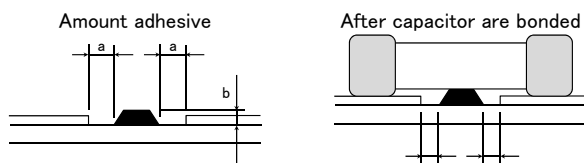

4. Soldering

◆ Selection of Flux

Since flux may have a significant effect on the performance of capacitors, it is necessary to verify the following conditions prior to use;

- (1) Flux used shall be less than or equal to 0.1 wt% (in Cl equivalent) of halogenated content. Flux having a strong acidity content shall not be applied.
- (2) When shall capacitors are soldered on boards, the amount of flux applied shall be controlled at the optimum level.
- (3) When water-soluble flux is used, special care shall be taken to properly clean the boards.

Precautions

◆ Soldering

Temperature, time, amount of solder, etc. shall be set in accordance with their recommended conditions.

Sn-Zn solder paste can adversely affect MLCC reliability.

Please contact us prior to usage of Sn-Zn solder.

Technical considerations

◆ Selection of Flux

1-1. When too much halogenated substance (Chlorine, etc.) content is used to activate flux, or highly acidic flux is used, it may lead to corrosion of terminal electrodes or degradation of insulation resistance on the surfaces of the capacitors.

1-2. Flux is used to increase solderability in wave soldering. However if too much flux is applied, a large amount of flux gas may be emitted and may adversely affect the solderability. To minimize the amount of flux applied, it is recommended to use a flux-bubbling system.

1-3. Since the residue of water-soluble flux is easily dissolved in moisture in the air, the residues on the surfaces of capacitors in high humidity conditions may cause a degradation of insulation resistance and reliability of the capacitors. Therefore, the cleaning methods and the capability of the machines used shall also be considered carefully when water-soluble flux is used.

▶ This catalog contains the typical specification only due to the limitation of space. When you consider the purchase of our products, please check our specification. For details of each product (characteristics graph, reliability information, precautions for use, and so on), see our Web site (<http://www.ty-top.com/>).

◆Soldering

- Ceramic chip capacitors are susceptible to thermal shock when exposed to rapid or concentrated heating or rapid cooling.
- Therefore, the soldering must be conducted with great care so as to prevent malfunction of the components due to excessive thermal shock.
- Preheating : Capacitors shall be preheated sufficiently, and the temperature difference between the capacitors and solder shall be within 130°C.
- Cooling : The temperature difference between the capacitors and cleaning process shall not be greater than 100°C.

[Reflow soldering]

【Recommended conditions for eutectic soldering】

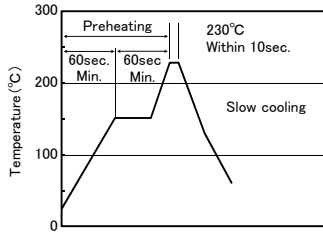

【Recommended condition for Pb-free soldering】

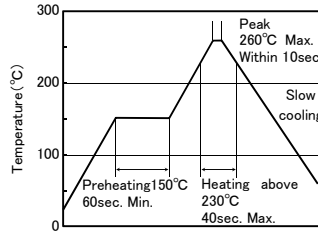

Caution

- ①The ideal condition is to have solder mass(fillet) controlled to 1/2 to 1/3 of the thickness of a capacitor.
- ②Because excessive dwell times can adversely affect solderability, soldering duration shall be kept as close to recommended times as possible. soldering for 2 times.

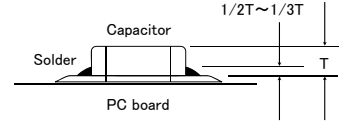

[Wave soldering]

【Recommended conditions for eutectic soldering】

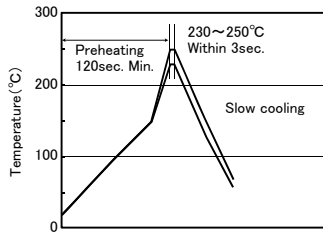

【Recommended condition for Pb-free soldering】

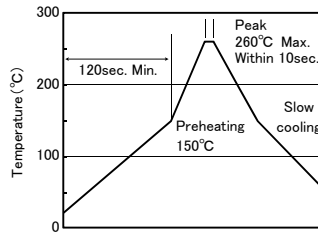

Caution

- ①Wave soldering must not be applied to capacitors designated as for reflow soldering only. soldering for 1 times.

[Hand soldering]

【Recommended conditions for eutectic soldering】

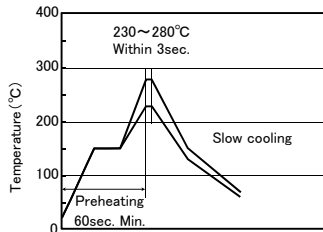

【Recommended condition for Pb-free soldering】

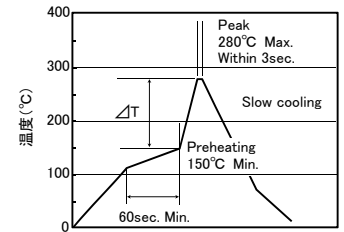
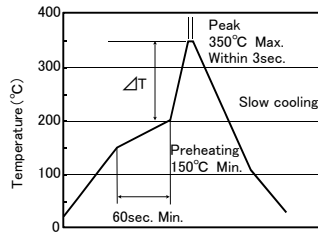

316type or less	$\Delta T \leq 150^{\circ}\text{C}$
-----------------	-------------------------------------

325type or more	$\Delta T \leq 130^{\circ}\text{C}$
-----------------	-------------------------------------

Caution

- ①Use a 50W soldering iron with a maximum tip diameter of 1.0 mm.
- ②The soldering iron shall not directly touch capacitors. soldering for 1 times.

5. Cleaning	
Precautions	<p>◆Cleaning conditions</p> <ol style="list-style-type: none"> When PCBs are cleaned after capacitors mounting, please select the appropriate cleaning solution in accordance with the intended use of the cleaning. (e.g. to remove soldering flux or other materials from the production process.) Cleaning condition shall be determined after it is verified by using actual cleaning machine that the cleaning process does not affect capacitor's characteristics.
Technical considerations	<ol style="list-style-type: none"> The use of inappropriate cleaning solutions can cause foreign substances such as flux residue to adhere to capacitors or deteriorate their outer coating, resulting in a degradation of the capacitor's electrical properties (especially insulation resistance). Inappropriate cleaning conditions (insufficient or excessive cleaning) may adversely affect the performance of the capacitors. In the case of ultrasonic cleaning, too much power output can cause excessive vibration of PCBs which may lead to the cracking of capacitors or the soldered portion, or decrease the terminal electrodes' strength. Therefore, the following conditions shall be carefully checked: Ultrasonic output : 20 W/ℓ or less Ultrasonic frequency : 40 kHz or less Ultrasonic washing period : 5 min. or less

6. Resin coating and mold	
Precautions	<ol style="list-style-type: none"> With some type of resins, decomposition gas or chemical reaction vapor may remain inside the resin during the hardening period or while left under normal storage conditions resulting in the deterioration of the capacitor's performance. When a resin's hardening temperature is higher than capacitor's operating temperature, the stresses generated by the excessive heat may lead to damage or destruction of capacitors. The use of such resins, molding materials etc. is not recommended.

7. Handling	
Precautions	<p>◆Splitting of PCB</p> <ol style="list-style-type: none"> When PCBs are split after components mounting, care shall be taken so as not to give any stresses of deflection or twisting to the board. Board separation shall not be done manually, but by using the appropriate devices. <p>◆Mechanical considerations</p> <p>Be careful not to subject capacitors to excessive mechanical shocks.</p> <ol style="list-style-type: none"> If ceramic capacitors are dropped onto a floor or a hard surface, they shall not be used. Please be careful that the mounted components do not come in contact with or bump against other boards or components.

8. Storage conditions	
Precautions	<p>◆Storage</p> <ol style="list-style-type: none"> To maintain the solderability of terminal electrodes and to keep packaging materials in good condition, care must be taken to control temperature and humidity in the storage area. Humidity should especially be kept as low as possible. <ul style="list-style-type: none"> Recommended conditions Ambient temperature : Below 30°C Humidity : Below 70% RH The ambient temperature must be kept below 40°C. Even under ideal storage conditions, solderability of capacitor is deteriorated as time passes, so capacitors shall be used within 6 months from the time of delivery. <ul style="list-style-type: none"> Ceramic chip capacitors shall be kept where no chlorine or sulfur exists in the air. The capacitance values of high dielectric constant capacitors will gradually decrease with the passage of time, so care shall be taken to design circuits. Even if capacitance value decreases as time passes, it will get back to the initial value by a heat treatment at 150°C for 1hour.
Technical considerations	<p>If capacitors are stored in a high temperature and humidity environment, it might rapidly cause poor solderability due to terminal oxidation and quality loss of taping/packaging materials. For this reason, capacitors shall be used within 6 months from the time of delivery. If exceeding the above period, please check solderability before using the capacitors.</p>

※RCR-2335B (Safety Application Guide for fixed ceramic capacitors for use in electronic equipment) is published by JEITA.

Please check the guide regarding precautions for deflection test, soldering by spot heat, and so on.

X-ON Electronics

Largest Supplier of Electrical and Electronic Components

Click to view similar products for [Multilayer Ceramic Capacitors MLCC - SMD/SMT category](#):

Click to view products by [Taiyo Yuden manufacturer](#):

Other Similar products are found below :

[D55342E07B523DR-T/R](#) [NCA1206X7R103K50TRPF](#) [NCA1206X7R104K16TRPF](#) [NIN-FB391JTRF](#) [NIN-FC2R7JTRF](#)
[NMC0402NPO220J50TRPF](#) [NMC0402X5R105K6.3TRPF](#) [NMC0402X5R224K6.3TRPF](#) [NMC0402X7R103J25TRPF](#)
[NMC0402X7R153K16TRPF](#) [NMC0603NPO330G50TRPF](#) [NMC0603NPO331F50TRPF](#) [NMC0603X5R475M6.3TRPF](#)
[NMC0805NPO220J100TRPF](#) [NMC0805NPO270J50TRPF](#) [NMC0805NPO681F50TRPF](#) [NMC0805NPO820J50TRPF](#)
[NMC1206X7R102K50TRPF](#) [NMC1210Y5V105Z50TRPLPF](#) [NMC-H0805X7R472K250TRPF](#) [NMC-L0402NPO7R0C50TRPF](#) [NMC-](#)
[L0603NPO2R2B50TRPF](#) [NMC-Q0402NPO8R2D200TRPF](#) [C1206C101J1GAC](#) [C1608C0G2A221J](#) [C1608X7R1E334K](#) [C2012C0G2A472J](#)
[2220J2K00562KXT](#) [KHC201E225M76N0T00](#) [1812J2K00332KXT](#) [CCR06CG153FSV](#) [CDR14BP471CJUR](#) [CDR31BX103AKWR](#)
[CDR33BX683AKUS](#) [CGA2B2C0G1H010C](#) [CGA2B2C0G1H040C](#) [CGA2B2C0G1H050C](#) [CGA2B2C0G1H060D](#) [CGA2B2C0G1H070D](#)
[CGA2B2C0G1H120J](#) [CGA2B2C0G1H151J](#) [CGA2B2C0G1H1R5C](#) [CGA2B2C0G1H2R2C](#) [CGA2B2C0G1H390J](#) [CGA2B2C0G1H391J](#)
[CGA2B2C0G1H3R3C](#) [CGA2B2C0G1H680J](#) [CGA2B2C0G1H6R8D](#) [CGA2B2C0G1H820J](#) [CGA2B2X8R1H152K](#)