

## 有关敝公司产品的注意事项

请务必在使用敝公司产品之前阅读。



注意

### ■ 产品目录中的记载内容

本产品目录中所记载的内容为2021年1月的内容。因产品改良等原因，可能会不经预告而变更其记载内容，或是停止供应本产品目录中所记载的产品。所以，请务必在使用前先确认最新的产品信息。

未按照本产品目录中所记载的内容或交货规格说明书使用敝公司产品，即便其致使用设备发生损害、不良情况等时，敝公司也不承担任何责任，敬请知悉。

### ■ 签署交货规格说明书

就本产品目录中所记载产品的产品规格等相关内容，敝公司备有交货规格说明书，详情请向敝公司咨询。在使用敝公司产品前请务必就交货规格说明书之内容确认并批准之。

### ■ 实装前的事前评估

使用敝公司产品时，请务必事先安装到使用设备之后，在实际使用的环境下进行评估和确认。

### ■ 用途的限定

#### 1. 可以使用的设备

本产品目录中所记载的产品预设为使用于一般电子设备 [音像设备、办公自动化设备、家电产品、办公设备、信息通讯设备 (手机、电脑等)] 以及面向本产品目录或是交货规格说明书中另行注明的设备通用性、标准性用途。

另外，面向汽车用电子设备、电信基础设施 / 工业设备、医疗设备 (国际 (GHTF) 第一类、第二类、第三类) 方面的应用，敝公司也有预设的产品线，请参考本产品目录或是交货规格说明书的内容，使用相对应的产品。

#### 2. 需要另行确认的设备

若考虑将本产品目录中所记载的产品使用于当产品发生故障、品质不良，或是由此引起的运转失常而可能会危及生命、身体或是财产，以及有可能给社会造成深刻影响的以下设备 (不包括本产品目录或是交货规格说明书中另行注明可以使用设备) 等时，请务必事先向敝公司咨询。

- (1) 运输用设备 (汽车驱动控制设备、火车控制设备、船舶控制设备等)
- (2) 交通信号设备
- (3) 防灾 / 保安设备
- (4) 医疗设备 (国际 (GHTF) 第三类)
- (5) 高公共性信息通讯设备 / 信息处理设备 (电话交换机、电话 / 无线 / 广播电视基站等)
- (6) 其他与上述设备有同等品质与可靠性要求的设备

#### 3. 禁止使用的设备

请勿将敝公司产品使用于对安全性和可靠性有着极高要求的以下设备。

- (1) 航天设备 (人工卫星、火箭等)
- (2) 航空设备 <sup>(注释1)</sup>
- (3) 医疗设备 (国际 (GHTF) 第四类)、植体 (体内植入型) 医疗设备 <sup>(注释2)</sup>
- (4) 发电控制设备 (面向核能 / 水力 / 火力发电厂等的设备)
- (5) 海底设备 (海底中继设备、海中的作业设备等)
- (6) 军事设备
- (7) 其他与上述设备有同等品质与可靠性要求的设备

注释 1：仅限于对航空设备的安全运行不产生直接干扰的设备 [机内娱乐设备、机内照明设备、电动座椅、餐饮设备等]，在满足敝公司另行指定的相关条件时，亦可将敝公司产品用于以上用途。在贵公司考虑将敝公司的产品用于以上用途时，请务必事先向敝公司咨询相关的信息。

注释 2：包括注入人体内的部分和与此相连接的体外部分。

#### 4. 责任的限制

未经敝公司的事先书面同意，把本产品目录中所记载的产品使用于非敝公司预设用途的设备、前述需要向敝公司咨询的设备或敝公司禁止使用的设备，从而给客户或第三方造成损害的，敝公司不承担任何责任，敬请知悉。

### ■ 安全设计

需将敝公司的产品使用于对安全性和可靠性要求较高的设备、电路上时，请进行充分的安全性评估和可靠性评估。另外，请通过设置保护电路、保护装置的系统，设置冗余电路不会被单一故障影响安全性的系统等失效导向安全 (fail-safe) 设计，确保充分的安全性。

### ■ 有关知识产权

本产品目录中所记载的信息是用于说明相关产品的典型操作以及相关应用。此类信息的使用不代表对于敝公司以及第三方的知识产权以及其他权利的使用许可或是不侵权保证。

### ■ 保证范围

敝公司产品的保证范围仅限于已经交付的敝公司产品本身，由敝公司产品的故障或不良情况所诱发的损害，敝公司不承担任何责任，敬请知悉。但是，以书面形式另行签署了交易基本合同书、品质保证协定书等时，敝公司将根据该合同的条件提供保证。

### ■ 正规销售渠道

本产品目录中所记载的内容适用于从敝公司营业所、销售子公司、销售代理店 (即“正规销售渠道”) 购买的敝公司产品，并不适用于从其他渠道购买的敝公司产品，敬请知悉。

### ■ 出口时的注意事项

本产品目录中所记载的部分产品在出口时须事先确认《外汇和对外贸易法》以及美国在出口管理方面的相关法规，并办理相关手续。如有不明之处，请向敝公司咨询。

## 多层陶瓷电容器

波峰焊 回流焊

■型号标示法

J	M	K	3	1	6	△	B	J	1	0	6	M	L	—	T	△
①	②	③	④	⑤	⑥	⑦	⑧	⑨	⑩	⑪	⑫					

△=空格

## ①额定电压

代码	额定电压 [VDC]
P	2.5
A	4
J	6.3
L	10
E	16
T	25
G	35
U	50
H	100
Q	250
S	630
X	2000

## ②系列名称

代码	系列名称
M	多层电容器
V	高频多层电容器
W	LW 逆转型多层电容器

## ③端接类型

代码	端接类型
K	电镀
S	铜内部电极 (高频用)

## ④外型尺寸

外型	L × W [mm]	EIA (inch)
021	0.25 × 0.125	008004
042	0.4 × 0.2	01005
063	0.6 × 0.3	0201
105	1.0 × 0.5	0402
	0.52 × 1.0 ※	0204
107	1.6 × 0.8	0603
	0.8 × 1.6 ※	0306
212	2.0 × 1.25	0805
	1.25 × 2.0 ※	0508
316	3.2 × 1.6	1206
325	3.2 × 2.5	1210
432	4.5 × 3.2	1812

注: \*LW 逆转型 (□WK)

## ⑤产品尺寸公差

代码	外型	L [mm]	W [mm]	T [mm]
△	所有规格	标准	标准	标准
A	063	0.6±0.05	0.3±0.05	0.3±0.05
	105	1.0±0.10	0.5±0.10	0.5±0.10
	107	1.6+0.15/-0.05	0.8+0.15/-0.05	0.8+0.15/-0.05
	212	2.0+0.15/-0.05	1.25+0.15/-0.05	0.45±0.05
				0.85±0.10
				1.25+0.15/-0.05
316	3.2±0.20	1.6±0.20	0.85±0.10	
			1.6±0.20	
325	3.2±0.30	2.5±0.30	2.5±0.30	
B	063	0.6±0.09	0.3±0.09	0.3±0.09
	105	1.0+0.15/-0.05	0.5+0.15/-0.05	0.5+0.15/-0.05
	107	1.6+0.20/-0	0.8+0.20/-0	0.45±0.05
				0.8+0.20/-0
	212	2.0+0.20/-0	1.25+0.20/-0	0.45±0.05
				0.85±0.10
1.25+0.20/-0				
316	3.2±0.30	1.6±0.30	1.6±0.30	
C	105	1.0+0.20/-0	0.5+0.20/-0	0.5+0.20/-0
	063	0.6+0.25/-0	0.3+0.25/-0	0.3+0.25/-0
E	105	1.0+0.30/-0	0.5+0.30/-0	0.5+0.30/-0

注: 参照标准产品尺寸

△=空格

## ⑥温度特性

■高介电常数【超低失真多层陶瓷电容器除外】

代码	适用标准	温度范围 [°C]	基准温度 [°C]	静电容量变化率	静电容量允许偏差	允许偏差代码	
BJ	JIS	-25~+85	20	±10%	±10%	K	
	B				±20%	M	
EIA	X5R	-55~+85	25	±15%	±10%	K	
					±20%	M	
B7	EIA	X7R	-55~+125	25	±15%	±10%	K
						±20%	M
C6	EIA	X6S	-55~+105	25	±22%	±10%	K
						±20%	M
C7	EIA	X7S	-55~+125	25	±22%	±10%	K
						±20%	M
LD(※)	EIA	X5R	-55~+85	25	±15%	±10%	K
						±20%	M

注: ※LD 低失真大容量多层陶瓷电容器

△=空格

▶由于篇幅有限, 本产品目录中只记载了有代表性的产品规格, 若考虑使用敝公司产品时, 请确认交货规格说明书中的详细规格。  
另外, 有关各产品的详细信息(特性图、可靠性信息、使用时的注意事项等), 请参阅敝公司网站(<http://www.ty-top.com/>)。

## ■温度补偿用

代码	适用标准		温度范围 [°C]	基准温度 [°C]	静电容量变化率	静电容量允许偏差	允许偏差代码
CH	JIS	CH	-55~+125	20	0±60ppm/°C	±0.05pF	A
						±0.1pF	B
						±0.25pF	C
						±0.5pF	D
CJ	JIS	CJ	-55~+125	20	0±120ppm/°C	±5%	J
						±0.1pF	B
						±0.25pF	C
CK	JIS	CK	-55~+125	20	0±250ppm/°C	±0.05pF	A
						±0.1pF	B
						±0.25pF	C
UJ	JIS	UJ	-55~+125	20	-750±120ppm/°C	±0.25pF	C
						±0.5pF	D
						±5%	J
UK	JIS	UK	-55~+125	20	-750±250ppm/°C	±0.25pF	C

## ⑥系列名称

· 超低失真多层陶瓷电容器

代码	系列名称
SD	标准品

· 中高耐压多层陶瓷电容器

代码	系列名称
SD	标准品

## ⑦静电容量

代码 (例)	静电容量
0R5	0.5pF
010	1pF
100	10pF
101	100pF
102	1,000pF
103	10,000pF
104	0.1 μF
105	1 μF
106	10 μF
107	100 μF

注: R = 小数点

## ⑧静电容量允许偏差

代码	静电容量允许偏差
A	±0.05pF
B	±0.1pF
C	±0.25pF
D	±0.5pF
F	±1pF
G	±2%
J	±5%
K	±10%
M	±20%
Z	+80/-20%

## ⑨产品厚度

代码	产品厚度 [mm]
K	0.125
H	0.13
E	0.18
C	0.2
D	0.2
P	0.3
T	0.3
K	0.45(107型以上)
V	0.5
W	0.5
A	0.8
D	0.85(212型以上)
F	1.15
G	1.25
L	1.6
N	1.9
Y	2.0 max
M	2.5

## ⑩个别规格

代码	个别规格
-	标准

## ⑪包装

代码	包装规格
F	φ178mm 卷盘带装 (2mm 间隔)
T	φ178mm 卷盘带装 (4mm 间隔)
P	φ178mm 卷盘带装 (4mm 间隔, 1000 个/卷盘) 325 规格 (厚度代码 M)
R	φ178mm 压模带 (2mm 间隔) 105 规格专用 (厚度代码 E,H)
W	φ178mm 压模带 (1mm 间隔) 021/042 规格专用

## ⑫管理记号

代码	管理记号
△	标准

## 标准产品尺寸

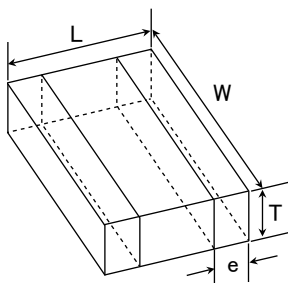
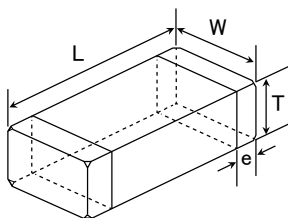

※LW 逆转型

Type( EIA )	标准产品尺寸 [mm]				
	L	W	T	*1	e
□MK021(008004)	0.25±0.013	0.125±0.013	0.125±0.013	K	0.0675±0.0275
□VS021(008004)	0.25±0.013	0.125±0.013	0.125±0.013	K	0.0675±0.0275
□MK042(01005)	0.4±0.02	0.2±0.02	0.2±0.02	C	0.1±0.03
				D	
□VS042(01005)	0.4±0.02	0.2±0.02	0.2±0.02	C	0.1±0.03
□MK063(0201)	0.6±0.03	0.3±0.03	0.3±0.03	P	0.15±0.05
				T	
□MK105(0402)	1.0±0.05	0.5±0.05	0.13±0.02	H	0.25±0.10
			0.18±0.02	E	
			0.2±0.02	C	
			0.3±0.03	P	
			0.5±0.05	V	
□VK105(0402)	1.0±0.05	0.5±0.05	0.5±0.05	W	0.25±0.10
□WK105(0204)※	0.52±0.05	1.0±0.05	0.3±0.05	P	0.18±0.08
□MK107(0603)	1.6±0.10	0.8±0.10	0.45±0.05	K	0.35±0.25
			0.8±0.10	A	
□WK107(0306)※	0.8±0.10	1.6±0.10	0.5±0.05	V	0.25±0.15
□MK212(0805)	2.0±0.10	1.25±0.10	0.45±0.05	K	0.5±0.25
			0.85±0.10	D	
			1.25±0.10	G	
□WK212(0508)※	1.25±0.15	2.0±0.15	0.85±0.10	D	0.3±0.2
			0.85±0.10	D	
□MK316(1206)	3.2±0.15	1.6±0.15	1.15±0.10	F	0.5+0.35/-0.25
			1.6±0.20	L	
			0.85±0.10	D	
□MK325(1210)	3.2±0.30	2.5±0.20	1.15±0.10	F	0.6±0.3
			1.9±0.20	N	
			1.9+0.1/-0.2	Y	
			2.5±0.20	M	
			2.0+0/-0.30	Y	
□MK432(1812)	4.5±0.40	3.2±0.30	2.5±0.20	M	0.6±0.4
			2.5±0.20	M	0.9±0.6

注: ※LW 逆转型、\*1 产品厚度代码

## 标准包装

形状	EIA (inch)	产品厚度		标准数量 [pcs]				
		[mm]	代码	纸带	压模带			
021	008004	0.125	K	—	50000			
042	01005	0.2	C	—	40000			
			D					
063	0201	0.3	P	15000	—			
			T					
105	0402	0.13	H	—	20000			
			0.18			E		
			0.2			C		
			0.3			P		
			0.5			V	15000	—
						W		
						10000		
0204 ※	0.30	P	—					
107	0603	0.45	K	4000	—			
			0.8			A		
			0306 ※			0.50	V	—
212	0805	0.45	K	4000	—			
			0.85			D		
			1.25			G		
			0508 ※			0.85	D	4000
316	1206	0.85	D	4000	—			
			1.15			F		
			1.6			L		
325	1210	0.85	D	—	2000			
			1.15			F		
			1.9			N		
			2.0 max			Y		
			2.5			M		
432	1812	2.0 max	Y	—	1000			
			2.5			M	—	500

注: ※LW 逆转型(□WK)

▶ 由于篇幅有限, 本产品目录中只记载了有代表性的产品规格, 若考虑使用敝公司产品时, 请确认交货规格说明书中的详细规格。另外, 有关各产品的详细信息(特性图、可靠性信息、使用时的注意事项等), 请参阅敝公司网站(<http://www.ty-top.com/>)。

• 产品目录中的多层陶瓷电容器全部属于RoHS对应品。  
• 型号的 □ 中将会记入静电容量允许偏差代码。

注)

\*1 根据个别规格的约定，将存在对应X7R/X7S规格的情况。

\*2 根据使用电路和机器，需要按照相应规格处理。请务必咨询正规销售渠道。

\*3 关于尺寸规格，请参照型号标示法4外形尺寸、⑤产品尺寸允许误差、⑨产品厚度及标准产品的尺寸。

多层陶瓷电容器 (高介电常数)

●021规格

【温度特性 BJ : X5R ( - 55 ~ + 85°C )】 0.125mm厚度 (K)

型号1	型号2	额定电压 [V]	温度特性	静电容量 [F]	静电容量允许偏差 [%]	tanδ [%]	高温负载	厚度 <sup>-3</sup> [mm]	焊接方式 R: 回流焊 W: 波峰焊
							额定电压 x %		
EMK021 BJ221□K-W		16	X5R	220 p	±10, ±20	10	150	0.125±0.013	R
EMK021 BJ471□K-W			X5R	470 p	±10, ±20	10	150	0.125±0.013	R
EMK021 BJ102□K-W			X5R	1000 p	±10, ±20	10	150	0.125±0.013	R
JMK021 BJ222□K-W		6.3	X5R	2200 p	±10, ±20	10	150	0.125±0.013	R
JMK021 BJ472□K-W			X5R	4700 p	±10, ±20	10	150	0.125±0.013	R
JMK021 BJ103□K-W			X5R	0.01 μ	±10, ±20	10	150	0.125±0.013	R
AMK021 BJ223MK-W		4	X5R	0.022 μ	±20	10	150	0.125±0.013	R

●042规格

【温度特性 BJ : B ( - 25 ~ + 85°C ) / X5R ( - 55 ~ + 85°C )】 0.2mm厚度 (C)

型号1	型号2	额定电压 [V]	温度特性	静电容量 [F]	静电容量允许偏差 [%]	tanδ [%]	高温负载	厚度 <sup>-3</sup> [mm]	焊接方式 R: 回流焊 W: 波峰焊			
							额定电压 x %					
EMK042 BJ101□C-W		16	X5R	100 p	±10, ±20	5	200	0.2±0.02	R			
EMK042 BJ151□C-W			X5R	150 p	±10, ±20	5	200	0.2±0.02	R			
EMK042 BJ221□C-W			X5R	220 p	±10, ±20	5	200	0.2±0.02	R			
EMK042 BJ331□C-W			X5R	330 p	±10, ±20	5	200	0.2±0.02	R			
EMK042 BJ471□C-W			X5R	470 p	±10, ±20	5	200	0.2±0.02	R			
EMK042 BJ681□C-W			X5R	680 p	±10, ±20	5	200	0.2±0.02	R			
EMK042 BJ102□C-W			10	B	X5R	1000 p	±10, ±20	5	200	0.2±0.02		
EMK042 BJ152□C-W				X5R	1500 p	±10, ±20	10	150	0.2±0.02	R		
EMK042 BJ222□C-W				X5R	2200 p	±10, ±20	10	150	0.2±0.02	R		
EMK042 BJ332□C-W				X5R	3300 p	±10, ±20	10	150	0.2±0.02	R		
EMK042 BJ472□C-W				X5R	4700 p	±10, ±20	10	150	0.2±0.02	R		
EMK042 BJ682□C-W				X5R	6800 p	±10, ±20	10	150	0.2±0.02	R		
EMK042 BJ103□C-W				X5R	0.01 μ	±10, ±20	10	150	0.2±0.02	R		
LMK042 BJ101□C-W				6.3	X5R <sup>*1</sup>	100 p	±10, ±20	5	200	0.2±0.02	R	
LMK042 BJ151□C-W					X5R <sup>*1</sup>	150 p	±10, ±20	5	200	0.2±0.02	R	
LMK042 BJ221□C-W					X5R <sup>*1</sup>	220 p	±10, ±20	5	200	0.2±0.02	R	
LMK042 BJ331□C-W					X5R <sup>*1</sup>	330 p	±10, ±20	5	200	0.2±0.02	R	
LMK042 BJ471□C-W					X5R <sup>*1</sup>	470 p	±10, ±20	5	200	0.2±0.02	R	
LMK042 BJ681□C-W					X5R <sup>*1</sup>	680 p	±10, ±20	5	200	0.2±0.02	R	
LMK042 BJ102□C-W					4	B	X5R <sup>*1</sup>	1000 p	±10, ±20	5	200	0.2±0.02
LMK042 BJ152□C-W						X5R	1500 p	±10, ±20	10	150	0.2±0.02	R
LMK042 BJ222□C-W						X5R	2200 p	±10, ±20	10	150	0.2±0.02	R
LMK042 BJ332□C-W						X5R	3300 p	±10, ±20	10	150	0.2±0.02	R
LMK042 BJ472□C-W						X5R	4700 p	±10, ±20	10	150	0.2±0.02	R
LMK042 BJ682□C-W		X5R				6800 p	±10, ±20	10	150	0.2±0.02	R	
LMK042 BJ103□C-W		X5R				0.01 μ	±10, ±20	10	150	0.2±0.02	R	
JMK042 BJ152□C-W		6.3				X5R <sup>*1</sup>	1500 p	±10, ±20	10	150	0.2±0.02	R
JMK042 BJ222□C-W						X5R <sup>*1</sup>	2200 p	±10, ±20	10	150	0.2±0.02	R
JMK042 BJ332□C-W						X5R <sup>*1</sup>	3300 p	±10, ±20	10	150	0.2±0.02	R
JMK042 BJ472□C-W						X5R <sup>*1</sup>	4700 p	±10, ±20	10	150	0.2±0.02	R
JMK042 BJ682□C-W			X5R <sup>*1</sup>			6800 p	±10, ±20	10	150	0.2±0.02	R	
JMK042 BJ103□C-W			X5R <sup>*1</sup>			0.01 μ	±10, ±20	10	150	0.2±0.02	R	
JMK042 BJ223□C-W			X5R			0.022 μ	±10, ±20	10	150	0.2±0.02	R	
JMK042 BJ473□C-W			X5R			0.047 μ	±10, ±20	10	150	0.2±0.02	R	
JMK042 BJ104□C-W			X5R			0.1 μ	±10, ±20	10	150	0.2±0.02	R	
AMK042 BJ473□C-W			4			X5R	0.047 μ	±10, ±20	10	150	0.2±0.02	R
AMK042 BJ104□C-W						X5R	0.1 μ	±10, ±20	10	150	0.2±0.02	R

【温度特性 B7 : X7R ( - 55 ~ + 125°C )】 0.2mm厚度 (C)

型号1	型号2	额定电压 [V]	温度特性	静电容量 [F]	静电容量允许偏差 [%]	tanδ [%]	高温负载	厚度 <sup>-3</sup> [mm]	焊接方式 R: 回流焊 W: 波峰焊	
							额定电压 x %			
EMK042 B7101□C-W		16	X7R	100 p	±10, ±20	5	200	0.2±0.02	R	
EMK042 B7151□C-W			X7R	150 p	±10, ±20	5	200	0.2±0.02	R	
EMK042 B7221□C-W			X7R	220 p	±10, ±20	5	200	0.2±0.02	R	
EMK042 B7331□C-W			X7R	330 p	±10, ±20	5	200	0.2±0.02	R	
EMK042 B7471□C-W			X7R	470 p	±10, ±20	5	200	0.2±0.02	R	
EMK042 B7681□C-W			X7R	680 p	±10, ±20	5	200	0.2±0.02	R	
EMK042 B7102□C-W			10	X7R	1000 p	±10, ±20	5	200	0.2±0.02	R
LMK042 B7101□C-W				X7R	100 p	±10, ±20	5	200	0.2±0.02	R
LMK042 B7151□C-W				X7R	150 p	±10, ±20	5	200	0.2±0.02	R
LMK042 B7221□C-W				X7R	220 p	±10, ±20	5	200	0.2±0.02	R
LMK042 B7331□C-W				X7R	330 p	±10, ±20	5	200	0.2±0.02	R
LMK042 B7471□C-W				X7R	470 p	±10, ±20	5	200	0.2±0.02	R
LMK042 B7681□C-W		X7R		680 p	±10, ±20	5	200	0.2±0.02	R	
LMK042 B7102□C-W		4		X7R	1000 p	±10, ±20	5	200	0.2±0.02	R
EMK042 B7101□C-W				X7R	100 p	±10, ±20	5	200	0.2±0.02	R
EMK042 B7151□C-W				X7R	150 p	±10, ±20	5	200	0.2±0.02	R
EMK042 B7221□C-W				X7R	220 p	±10, ±20	5	200	0.2±0.02	R
EMK042 B7331□C-W				X7R	330 p	±10, ±20	5	200	0.2±0.02	R
EMK042 B7471□C-W			X7R	470 p	±10, ±20	5	200	0.2±0.02	R	

▶ 由于篇幅有限，本产品目录中只记载了有代表性的产品规格，若考虑使用敝公司产品时，请确认交货规格说明书中的详细规格。另外，有关各产品的详细信息(特性图、可靠性信息、使用时的注意事项等)，请参阅敝公司网站 (<http://www.ty-top.com/>)。

●063规格  
【温度特性 B: B (-25 ~ +85°C) / X5R (-55 ~ +85°C)】 0.3mm厚度 (P)

型号1	型号2	额定电压 [V]	温度特性	静电容量 [F]	静电容量允许偏差 [%]	tanδ [%]	高温负载	厚度 <sup>3</sup> [mm]	焊接方式 R: 回流焊 W: 波峰焊	
							额定电压 x %			
UMK063 BJ101□P-F		50	B	X5R <sup>-1</sup>	100 p	±10, ±20	3.5	200	0.3±0.03	R
UMK063 BJ151□P-F			B	X5R <sup>-1</sup>	150 p	±10, ±20	3.5	200	0.3±0.03	R
UMK063 BJ221□P-F			B	X5R <sup>-1</sup>	220 p	±10, ±20	3.5	200	0.3±0.03	R
UMK063 BJ331□P-F			B	X5R <sup>-1</sup>	330 p	±10, ±20	3.5	200	0.3±0.03	R
UMK063 BJ471□P-F			B	X5R <sup>-1</sup>	470 p	±10, ±20	3.5	200	0.3±0.03	R
UMK063 BJ681□P-F			B	X5R <sup>-1</sup>	680 p	±10, ±20	3.5	200	0.3±0.03	R
UMK063 BJ102□P-F			B	X5R <sup>-1</sup>	1000 p	±10, ±20	3.5	200	0.3±0.03	R
UMK063 BJ152□P-F			B	X5R	1500 p	±10, ±20	5	200	0.3±0.03	R
UMK063 BJ222□P-F			B	X5R	2200 p	±10, ±20	5	200	0.3±0.03	R
UMK063 BJ332□P-F			B	X5R	3300 p	±10, ±20	5	200	0.3±0.03	R
UMK063 BJ472□P-F			B	X5R	4700 p	±10, ±20	5	200	0.3±0.03	R
UMK063 BJ682□P-F			B	X5R	6800 p	±10, ±20	5	200	0.3±0.03	R
UMK063 BJ103□P-F			B	X5R	0.01 μ	±10, ±20	5	200	0.3±0.03	R
GMK063 BJ104□P-F			X5R	0.1 μ	±10, ±20	10	150	0.3±0.03	R	
TMK063 BJ152□P-F			B	X5R	1500 p	±10, ±20	5	200	0.3±0.03	R
TMK063 BJ222□P-F			B	X5R	2200 p	±10, ±20	5	200	0.3±0.03	R
TMK063 BJ332□P-F		B	X5R	3300 p	±10, ±20	5	200	0.3±0.03	R	
TMK063 BJ472□P-F		B	X5R	4700 p	±10, ±20	5	200	0.3±0.03	R	
TMK063 BJ682□P-F		B	X5R	6800 p	±10, ±20	5	200	0.3±0.03	R	
TMK063 BJ103□P-F		B	X5R	0.01 μ	±10, ±20	5	200	0.3±0.03	R	
TMK063 BJ223□P-F		B	X5R	0.022 μ	±10, ±20	7.5	200	0.3±0.03	R	
TMK063ABJ104□P-F		X5R	0.1 μ	±10, ±20	10	150	0.3±0.05	R		
EMK063 BJ152□P-F		B	X5R <sup>-1</sup>	1500 p	±10, ±20	5	200	0.3±0.03	R	
EMK063 BJ222□P-F		B	X5R <sup>-1</sup>	2200 p	±10, ±20	5	200	0.3±0.03	R	
EMK063 BJ332□P-F		B	X5R <sup>-1</sup>	3300 p	±10, ±20	5	200	0.3±0.03	R	
EMK063 BJ472□P-F		B	X5R <sup>-1</sup>	4700 p	±10, ±20	5	200	0.3±0.03	R	
EMK063 BJ682□P-F		B	X5R <sup>-1</sup>	6800 p	±10, ±20	5	200	0.3±0.03	R	
EMK063 BJ103□P-F		B	X5R <sup>-1</sup>	0.01 μ	±10, ±20	5	200	0.3±0.03	R	
EMK063 BJ153□P-F		X5R	0.015 μ	±10, ±20	7.5	200	0.3±0.03	R		
EMK063 BJ223□P-F		B	X5R	0.022 μ	±10, ±20	7.5	200	0.3±0.03	R	
EMK063 BJ333□P-F		X5R	0.033 μ	±10, ±20	7.5	150	0.3±0.03	R		
EMK063 BJ473□P-F		X5R	0.047 μ	±10, ±20	7.5	150	0.3±0.03	R		
EMK063 BJ683□P-F		X5R	0.068 μ	±10, ±20	10	150	0.3±0.03	R		
EMK063 BJ104□P-F		X5R	0.1 μ	±10, ±20	10	150	0.3±0.03	R		
EMK063 BJ224□P-F		X5R	0.22 μ	±10, ±20	10	150	0.3±0.03	R		
EMK063BBJ474□PLF		X5R	0.47 μ	±10, ±20	10	150	0.3±0.09	R		
LMK063 BJ223□P-F		B	X5R	0.022 μ	±10, ±20	7.5	150	0.3±0.03	R	
LMK063 BJ333□P-F		X5R	0.033 μ	±10, ±20	7.5	150	0.3±0.03	R		
LMK063 BJ473□P-F		X5R	0.047 μ	±10, ±20	7.5	150	0.3±0.03	R		
LMK063 BJ683□P-F		X5R	0.068 μ	±10, ±20	10	150	0.3±0.03	R		
LMK063 BJ104□P-F		X5R	0.1 μ	±10, ±20	10	150	0.3±0.03	R		
LMK063 BJ224□P-F		X5R	0.22 μ	±10, ±20	10	150	0.3±0.03	R		
LMK063BBJ474□PLF		X5R	0.47 μ	±10, ±20	10	150	0.3±0.09	R		
LMK063BBJ105MPLF		X5R	1 μ	±20	10	150	0.3±0.09	R		
JMK063 BJ104□P-F		X5R	0.1 μ	±10, ±20	10	150	0.3±0.03	R		
JMK063 BJ224□P-F		X5R	0.22 μ	±10, ±20	10	150	0.3±0.03	R		
JMK063 BJ334MP-F		X5R	0.33 μ	±20	10	150	0.3±0.03	R		
JMK063 BJ474□P-F		X5R	0.47 μ	±10, ±20	10	150	0.3±0.03	R		
JMK063ABJ105□P-F		X5R	1 μ	±10, ±20	10	150	0.3±0.05	R		
AMK063EBJ475MP-F		4	X5R	4.7 μ	±20	10	150	0.3+0.25/-0	R	
PMK063EBJ475MP-F		2.5	X5R	4.7 μ	±20	10	150	0.3+0.25/-0	R	

【温度特性 C6: X6S (-55 ~ +105°C)】 0.3mm厚度 (P)

型号1	型号2	额定电压 [V]	温度特性	静电容量 [F]	静电容量允许偏差 [%]	tanδ [%]	高温负载	厚度 <sup>3</sup> [mm]	焊接方式 R: 回流焊 W: 波峰焊
							额定电压 x %		
TMK063 C6104□P-F		25	X6S	0.1 μ	±10, ±20	10	150	0.3±0.03	R
EMK063AC6104□P-F		16	X6S	0.1 μ	±10, ±20	10	150	0.3±0.05	R
LMK063 C6104□P-F		10	X6S	0.1 μ	±10, ±20	10	150	0.3±0.03	R
LMK063 C6224□P-F			X6S	0.22 μ	±10, ±20	10	150	0.3±0.03	R
LMK063BC6474□PLF		X6S	0.47 μ	±10, ±20	10	150	0.3±0.09	R	
JMK063 C6104□P-F		6.3	X6S	0.1 μ	±10, ±20	10	150	0.3±0.03	R
JMK063 C6224□P-F			X6S	0.22 μ	±10, ±20	10	150	0.3±0.03	R
JMK063BC6474□P-F			X6S	0.47 μ	±10, ±20	10	150	0.3±0.09	R
JMK063BC6105MP-F			X6S	1 μ	±20	10	150	0.3±0.09	R
AMK063 C6474□P-F		4	X6S	0.47 μ	±10, ±20	10	150	0.3±0.03	R
AMK063AC6105□P-F			X6S	1 μ	±10, ±20	10	150	0.3±0.05	R

▶ 由于篇幅有限, 本产品目录中只记载了有代表性的产品规格, 若考虑使用敝公司产品时, 请确认交货规格说明书中的详细规格。另外, 有关各产品的详细信息(特性图、可靠性信息、使用时的注意事项等), 请参阅敝公司网站(<http://www.ty-top.com/>)。

■ 型号一览

【温度特性 B7 : X7R (-55 ~ +125°C)】 0.3mm厚度 (P)

型号1	型号2	额定电压 [V]	温度特性		静电容量 [F]	静电容量允许偏差 [%]	tanδ [%]	高温负载	厚度 <sup>-3</sup> [mm]	焊接方式 R: 回流焊 W: 波峰焊	
								额定电压 x %			
UMK063 B7101□P-F		50		X7R	100 p	±10, ±20	3.5	200	0.3±0.03	R	
UMK063 B7151□P-F				X7R	150 p	±10, ±20	3.5	200	0.3±0.03	R	
UMK063 B7221□P-F				X7R	220 p	±10, ±20	3.5	200	0.3±0.03	R	
UMK063 B7331□P-F				X7R	330 p	±10, ±20	3.5	200	0.3±0.03	R	
UMK063 B7471□P-F				X7R	470 p	±10, ±20	3.5	200	0.3±0.03	R	
UMK063 B7681□P-F				X7R	680 p	±10, ±20	3.5	200	0.3±0.03	R	
UMK063 B7102□P-F				X7R	1000 p	±10, ±20	3.5	200	0.3±0.03	R	
TMK063 B7152□P-F				X7R	1500 p	±10, ±20	5	200	0.3±0.03	R	
TMK063 B7222□P-F			25		X7R	2200 p	±10, ±20	5	200	0.3±0.03	R
TMK063 B7332□P-F					X7R	3300 p	±10, ±20	5	200	0.3±0.03	R
TMK063 B7472□P-F				X7R	4700 p	±10, ±20	5	200	0.3±0.03	R	
TMK063 B7682□P-F				X7R	6800 p	±10, ±20	5	200	0.3±0.03	R	
TMK063 B7103□P-F				X7R	0.01 μ	±10, ±20	5	200	0.3±0.03	R	
EMK063 B7152□P-F				X7R	1500 p	±10, ±20	5	200	0.3±0.03	R	
EMK063 B7222□P-F				X7R	2200 p	±10, ±20	5	200	0.3±0.03	R	
EMK063 B7332□P-F				X7R	3300 p	±10, ±20	5	200	0.3±0.03	R	
EMK063 B7472□P-F		16			X7R	4700 p	±10, ±20	5	200	0.3±0.03	R
EMK063 B7682□P-F					X7R	6800 p	±10, ±20	5	200	0.3±0.03	R
EMK063 B7103□P-F				X7R	0.01 μ	±10, ±20	5	200	0.3±0.03	R	
EMK063 B7223□P-F				X7R	0.022 μ	±10, ±20	7.5	150	0.3±0.03	R	

● 105规格

【温度特性 BJ : B (-25 ~ +85°C) / X5R (-55 ~ +85°C)】 0.5mm厚度 (V)

型号1	型号2	额定电压 [V]	温度特性		静电容量 [F]	静电容量允许偏差 [%]	tanδ [%]	高温负载	厚度 <sup>-3</sup> [mm]	焊接方式 R: 回流焊 W: 波峰焊		
								额定电压 x %				
UMK105 BJ223□V-F		50		X5R	0.022 μ	±10, ±20	5	200	0.5±0.05	R		
UMK105 BJ473□V-F				X5R	0.047 μ	±10, ±20	5	200	0.5±0.05	R		
UMK105 BJ104□V-F				X5R	0.1 μ	±10, ±20	10	150	0.5±0.05	R		
UMK105 BJ224□V-F				X5R	0.22 μ	±10, ±20	10	150	0.5±0.05	R		
UMK105ABJ474□V-F				X5R	0.47 μ	±10, ±20	10	150	0.5±0.10	R		
UMK105CBJ105□V-F					1 μ	±10, ±20	10	150	0.5+0.20/-0	R		
GMK105 BJ104□V-F			35	B	X5R	0.1 μ	±10, ±20	5	150	0.5±0.05	R	
GMK105ABJ105□V-F					X5R	1 μ	±10, ±20	10	150	0.5±0.10	R	
TMK105 BJ153□V-F					B	X5R <sup>1</sup>	0.015 μ	±10, ±20	3.5	200	0.5±0.05	R
TMK105 BJ223□V-F					B	X5R <sup>1</sup>	0.022 μ	±10, ±20	3.5	200	0.5±0.05	R
TMK105 BJ333□V-F				B	X5R <sup>1</sup>	0.033 μ	±10, ±20	3.5	150	0.5±0.05	R	
TMK105 BJ473□V-F				B	X5R <sup>1</sup>	0.047 μ	±10, ±20	3.5	150	0.5±0.05	R	
TMK105 BJ104□V-F		25		B	X5R	0.1 μ	±10, ±20	5	150	0.5±0.05	R	
TMK105 BJ224□V-F					X5R	0.22 μ	±10, ±20	10	200	0.5±0.05	R	
TMK105ABJ474□V-F					X5R	0.47 μ	±10, ±20	10	200	0.5±0.10	R	
TMK105 BJ105□V-F					X5R	1 μ	±10, ±20	10	150	0.5±0.05	R	
TMK105CBJ225□V-F				X5R	2.2 μ	±10, ±20	10	150	0.5+0.20/-0	R		
EMK105 BJ224□V-F			16	B	X5R	0.22 μ	±10, ±20	5	150	0.5±0.05	R	
EMK105ABJ474□V-F				X5R	0.47 μ	±10, ±20	10	200	0.5±0.10	R		
EMK105 BJ105□V-F				X5R	1 μ	±10, ±20	10	150	0.5±0.05	R		
EMK105ABJ225□V-F				X5R	2.2 μ	±10, ±20	10	150	0.5±0.10	R		
LMK105 BJ225□V-F		10			X5R	2.2 μ	±10, ±20	10	150	0.5±0.05	R	
LMK105BBJ475MVF					X5R	4.7 μ	±20	10	150	0.5+0.15/-0.05	R	
JMK105 BJ225□V-F		6.3		X5R	2.2 μ	±10, ±20	10	150	0.5±0.05	R		
JMK105BBJ475MV-F	JMK105 BJ475MV-FD			X5R	4.7 μ	±20	10	150	0.5+0.15/-0.05	R		
JMK105EBJ226MV-F				X5R	22 μ	±20	20	150	0.5+0.30/-0	R		
AMK105EBJ226MV-F			4	X5R	22 μ	±20	20	150	0.5+0.30/-0	R		

【温度特性 BJ : B (-25 ~ +85°C) / X5R (-55 ~ +85°C)】 0.3mm厚度 (P)

型号1	型号2	额定电压 [V]	温度特性		静电容量 [F]	静电容量允许偏差 [%]	tanδ [%]	高温负载	厚度 <sup>-3</sup> [mm]	焊接方式 R: 回流焊 W: 波峰焊	
								额定电压 x %			
UMK105 BJ104□P-F		50		X5R	0.1 μ	±10, ±20	10	150	0.3±0.03	R	
TMK105 BJ103□P-F				B	X5R	0.01 μ	±10, ±20	5	150	0.3±0.03	R
TMK105 BJ104□P-F			25		X5R	0.1 μ	±10, ±20	10	150	0.3±0.03	R
TMK105 BJ224□P-F					X5R	0.22 μ	±10, ±20	10	150	0.3±0.03	R
TMK105 BJ474□P-F		16		X5R	0.47 μ	±10, ±20	10	150	0.3±0.03	R	
EMK105 BJ474□P-F				X5R	0.47 μ	±10, ±20	10	150	0.3±0.03	R	
LMK105 BJ105□PLF		10		X5R	1 μ	±10, ±20	10	150	0.3±0.03	R	
JMK105 BJ105□P-F		6.3		X5R	1 μ	±10, ±20	10	150	0.3±0.03	R	
AMK105 BJ225MP-F		4		X5R	2.2 μ	±20	10	150	0.3±0.03	R	

【温度特性 BJ : X5R (-55 ~ +85°C)】 0.2mm厚度 (C)

型号1	型号2	额定电压 [V]	温度特性		静电容量 [F]	静电容量允许偏差 [%]	tanδ [%]	高温负载	厚度 <sup>-3</sup> [mm]	焊接方式 R: 回流焊 W: 波峰焊	
								额定电压 x %			
LMK105 BJ104□C-F		10		X5R	0.1 μ	±10, ±20	10	150	0.2±0.02	R	
JMK105 BJ224□C-F					X5R	0.22 μ	±10, ±20	10	150	0.2±0.02	R
JMK105 BJ474□C-F			6.3		X5R	0.47 μ	±10, ±20	10	150	0.2±0.02	R
JMK105 BJ105MC-F						X5R	1 μ	±20	10	150	0.2±0.02

【温度特性 BJ : X5R (-55 ~ +85°C)】 0.18mm厚度 (E)

型号1	型号2	额定电压 [V]	温度特性		静电容量 [F]	静电容量允许偏差 [%]	tanδ [%]	高温负载	厚度 <sup>-3</sup> [mm]	焊接方式 R: 回流焊 W: 波峰焊	
								额定电压 x %			
LMK105 BJ104□E-R		10		X5R	0.1 μ	±10, ±20	10	150	0.18±0.02	R	
JMK105 BJ224□E-R					X5R	0.22 μ	±10, ±20	10	150	0.18±0.02	R
JMK105 BJ474□E-R			6.3		X5R	0.47 μ	±10, ±20	10	150	0.18±0.02	R
AMK105 BJ105ME-R		4			X5R	1 μ	±20	10	150	0.18±0.02	R

▶ 由于篇幅有限, 本产品目录中只记载了有代表性的产品规格, 若考虑使用敝公司产品时, 请确认交货规格说明书中的详细规格。另外, 有关各产品的详细信息(特性图、可靠性信息、使用时的注意事项等), 请参阅敝公司网站(<http://www.ty-top.com/>)。

【温度特性 BJ: X5R (-55 ~ +85°C)】 0.13mm厚度 (H)

型号1	型号2	额定电压 [V]	温度特性	静电容量 [F]	静电容量允许偏差 [%]	tanδ [%]	高温负载	厚度 <sup>3</sup> [mm]	焊接方式 R: 回流焊 W: 波峰焊
							额定电压 x %		
LMK105 BJ104MH-R		10	X5R	0.1 μ	±20	10	150	0.13±0.02	R
JMK105 BJ224MH-R		6.3	X5R	0.22 μ	±20	10	150	0.13±0.02	R
AMK105 BJ474MH-R		4	X5R	0.47 μ	±20	10	150	0.13±0.02	R

【温度特性 C6: X6S (-55 ~ +105°C)】 0.5mm厚度 (V)

型号1	型号2	额定电压 [V]	温度特性	静电容量 [F]	静电容量允许偏差 [%]	tanδ [%]	高温负载	厚度 <sup>3</sup> [mm]	焊接方式 R: 回流焊 W: 波峰焊
							额定电压 x %		
GMK105C6105MV-F		35	X6S	1 μ	±20	10	150	0.5+0.20/-0	R
TMK105AC6105[V-F		25	X6S	1 μ	±10, ±20	10	150	0.5±0.10	R
EMK105 C6105[V-F		16	X6S	1 μ	±10, ±20	10	150	0.5±0.05	R
EMK105C6225[V-F			X6S	2.2 μ	±10, ±20	10	150	0.5+0.20/-0	R
LMK105 C6105[V-F		10	X6S	1 μ	±10, ±20	10	200	0.5±0.05	R
LMK105AC6225[V-F			X6S	2.2 μ	±10, ±20	10	150	0.5±0.10	R
JMK105 C6105[V-F		6.3	X6S	1 μ	±10, ±20	10	150	0.5±0.05	R
JMK105 C6225[V-F			X6S	2.2 μ	±10, ±20	10	150	0.5±0.05	R
JMK105BC6475MV-F			X6S	4.7 μ	±20	10	150	0.5+0.15/-0.05	R
AMK105BC6475MV-F		4	X6S	4.7 μ	±20	10	200	0.5+0.15/-0.05	R

【温度特性 B7: X7R (-55 ~ +125°C)】 0.5mm厚度 (V)

型号1	型号2	额定电压 [V]	温度特性	静电容量 [F]	静电容量允许偏差 [%]	tanδ [%]	高温负载	厚度 <sup>3</sup> [mm]	焊接方式 R: 回流焊 W: 波峰焊
							额定电压 x %		
UMK105 B7152[V-F		50	X7R	1500 p	±10, ±20	2.5	200	0.5±0.05	R
UMK105 B7222[V-F			X7R	2200 p	±10, ±20	2.5	200	0.5±0.05	R
UMK105 B7332[V-F			X7R	3300 p	±10, ±20	2.5	200	0.5±0.05	R
UMK105 B7472[V-F			X7R	4700 p	±10, ±20	2.5	150	0.5±0.05	R
UMK105 B7682[V-F			X7R	6800 p	±10, ±20	2.5	150	0.5±0.05	R
UMK105 B7103[V-F			X7R	0.01 μ	±10, ±20	3.5	150	0.5±0.05	R
UMK105 B7223[V-FR			X7R	0.022 μ	±10, ±20	10	200	0.5±0.05	R
UMK105 B7473[V-FR			X7R	0.047 μ	±10, ±20	10	200	0.5±0.05	R
UMK105 B7104[V-FR			X7R	0.1 μ	±10, ±20	10	150	0.5±0.05	R
TMK105 B7223[V-F			25	X7R	0.022 μ	±10, ±20	3.5	150	0.5±0.05
TMK105 B7473[V-F		X7R		0.047 μ	±10, ±20	3.5	150	0.5±0.05	R
TMK105 B7104[V-FR		X7R		0.1 μ	±10, ±20	10	200	0.5±0.05	R
TMK105 B7224[V-FR		X7R		0.22 μ	±10, ±20	10	150	0.5±0.05	R
EMK105 B7223[V-F		16	X7R	0.022 μ	±10, ±20	3.5	200	0.5±0.05	R
EMK105 B7473[V-F			X7R	0.047 μ	±10, ±20	3.5	200	0.5±0.05	R
EMK105 B7104[V-F			X7R	0.1 μ	±10, ±20	5	150	0.5±0.05	R
EMK105 B7224[V-FR		10	X7R	0.22 μ	±10, ±20	10	150	0.5±0.05	R
LMK105 B7224[V-FR			X7R	0.22 μ	±10, ±20	10	150	0.5±0.05	R
LMK105 B7474[V-F			X7R	0.47 μ	±10, ±20	10	150	0.5±0.05	R
JMK105 B7224[V-F			X7R	0.22 μ	±10, ±20	5	150	0.5±0.05	R
JMK105 B7474[V-F		6.3	X7R	0.47 μ	±10, ±20	10	150	0.5±0.05	R

● 107规格

【温度特性 BJ: B (-25 ~ +85°C) / X5R (-55 ~ +85°C)】 0.8mm厚度 (A)

型号1	型号2	额定电压 [V]	温度特性	静电容量 [F]	静电容量允许偏差 [%]	tanδ [%]	高温负载	厚度 <sup>3</sup> [mm]	焊接方式 R: 回流焊 W: 波峰焊
							额定电压 x %		
UMK107ABJ474[A-T	UMK107 BJ474[A-TD	50	X5R	0.47 μ	±10, ±20	10	150	0.8+0.15/-0.05	R
UMK107 BJ105[A-T			X5R	1 μ	±10, ±20	10	150	0.8±0.10	R
UMK107BBJ225[A-T			X5R	2.2 μ	±10, ±20	10	150	0.8+0.20/-0	R
GMK107BBJ475[A-T		35	X5R	4.7 μ	±10, ±20	10	150	0.8+0.20/-0	R
TMK107ABJ225[A-T	TMK107 BJ225[A-TD	25	X5R	2.2 μ	±10, ±20	10	150	0.8+0.15/-0.05	R
TMK107BBJ475[A-T			X5R	4.7 μ	±10, ±20	10	150	0.8+0.20/-0	R
TMK107BBJ106MA-T		16	X5R	10 μ	±20	10	150	0.8+0.20/-0	R
EMK107ABJ475[A-T	EMK107 BJ475[A-TD		X5R	4.7 μ	±10, ±20	10	150	0.8+0.15/-0.05	R
EMK107BBJ106MA-T			X5R	10 μ	±20	10	150	0.8+0.20/-0	R
LMK107BBJ106[ALT	LMK107 BJ106[ALTD	10	X5R	10 μ	±10, ±20	10	150	0.8+0.20/-0	R
LMK107BBJ226MA-T		6.3	X5R	22 μ	±20	10	150	0.8+0.20/-0	R
JMK107ABJ106[A-T	JMK107 BJ106[A-T		X5R	10 μ	±10, ±20	10	150	0.8+0.15/-0.05	R
JMK107BBJ226MA-T			X5R	22 μ	±20	10	150	0.8+0.20/-0	R
JMK107BBJ476MA-RE		4	X5R	47 μ	±20	15	150	0.8+0.20/-0	R
AMK107BBJ476MA-RE			X5R	47 μ	±20	20	150	0.8+0.20/-0	R

【温度特性 BJ: X5R (-55 ~ +85°C)】 0.45mm厚度 (K)

型号1	型号2	额定电压 [V]	温度特性	静电容量 [F]	静电容量允许偏差 [%]	tanδ [%]	高温负载	厚度 <sup>3</sup> [mm]	焊接方式 R: 回流焊 W: 波峰焊
							额定电压 x %		
TMK107 BJ105[K-T		25	X5R	1 μ	±10, ±20	10	150	0.45±0.05	R
EMK107 BJ105[K-T		16	X5R	1 μ	±10, ±20	10	150	0.45±0.05	R
EMK107BBJ225[K-T			X5R	2.2 μ	±10, ±20	10	150	0.45±0.05	R
LMK107 BJ105[K-T		10	X5R	1 μ	±10, ±20	10	150	0.45±0.05	R
LMK107 BJ225[K-T			X5R	2.2 μ	±10, ±20	10	150	0.45±0.05	R
LMK107BBJ475MKLT	LMK107 BJ475MKLTD		X5R	4.7 μ	±20	10	150	0.45±0.05	R
JMK107 BJ105[K-T		6.3	X5R	1 μ	±10, ±20	10	150	0.45±0.05	R
JMK107 BJ225[K-T			X5R	2.2 μ	±10, ±20	10	150	0.45±0.05	R
JMK107 BJ475MK-T			X5R	4.7 μ	±20	10	150	0.45±0.05	R
JMK107BBJ106MK-TT		4	X5R	10 μ	±20	10	150	0.45±0.05	R
AMK107BBJ106MK-T*2			X5R	10 μ	±20	10	150	0.45±0.05	R

▶ 由于篇幅有限，本产品目录中只记载了有代表性的产品规格，若考虑使用敝公司产品时，请确认交货规格说明书中的详细规格。另外，有关各产品的详细信息(特性图、可靠性信息、使用时的注意事项等)，请参阅敝公司网站(<http://www.ty-top.com/>)。



■ 型号一览

【温度特性 C6: X6S (-55 ~ +105°C)】 0.8mm厚度 (A)

型号1	型号2	额定电压 [V]	温度特性	静电容量 [F]	静电容量允许偏差 [%]	tanδ [%]	高温负载	厚度 <sup>3</sup> [mm]	焊接方式 R: 回流焊 W: 波峰焊
							额定电压 x %		
TMK107BC6225□A-T		25	X6S	2.2 μ	±10, ±20	10	150	0.8±0.20/-0	R
EMK107 C6105□A-T			X6S	1 μ	±10, ±20	5	150	0.8±0.10	R
EMK107BC6225□A-T			X6S	2.2 μ	±10, ±20	10	150	0.8±0.20/-0	R
EMK107BC6475□A-T			X6S	4.7 μ	±10, ±20	10	150	0.8±0.20/-0	R
EMK107BC6106MA-T		10	X6S	10 μ	±20	10	150	0.8±0.20/-0	R
LMK107 C6105□A-T			X6S	1 μ	±10, ±20	5	150	0.8±0.10	R
LMK107AC6475□A-T			X6S	4.7 μ	±10, ±20	10	150	0.8±0.15/-0.05	R
LMK107BC6106MA-T			X6S	10 μ	±20	10	150	0.8±0.20/-0	R
JMK107 C6475□A-T		6.3	X6S	4.7 μ	±10, ±20	10	150	0.8±0.10	R
JMK107BC6106MA-T			X6S	10 μ	±20	10	150	0.8±0.20/-0	R
JMK107BC6226MA-T			X6S	22 μ	±20	10	150	0.8±0.20/-0	R
AMK107BC6226MA-T			X6S	22 μ	±20	10	150	0.8±0.20/-0	R
AMK107BC6476MA-RE		4	X6S	47 μ	±20	20	150	0.8±0.20/-0	R
			X6S	47 μ	±20	20	150	0.8±0.20/-0	R

【温度特性 B7: X7R (-55 ~ +125°C)】 0.8mm厚度 (A)

型号1	型号2	额定电压 [V]	温度特性	静电容量 [F]	静电容量允许偏差 [%]	tanδ [%]	高温负载	厚度 <sup>3</sup> [mm]	焊接方式 R: 回流焊 W: 波峰焊
							额定电压 x %		
UMK107 B7224□A-TR		50	X7R	0.22 μ	±10, ±20	10	150	0.8±0.10	R
UMK107 B7474□A-TR			X7R	0.47 μ	±10, ±20	10	150	0.8±0.10	R
UMK107AB7105□A-T			X7R	1 μ	±10, ±20	10	150	0.8±0.15/-0.05	R
TMK107 B7474□A-TR			X7R	0.47 μ	±10, ±20	10	150	0.8±0.10	R
TMK107 B7105□A-T		25	X7R	1 μ	±10, ±20	10	150	0.8±0.10	R
EMK107 B7474□A-T			X7R	0.47 μ	±10, ±20	3.5	150	0.8±0.10	R
EMK107 B7105□A-T			X7R	1 μ	±10, ±20	5	150	0.8±0.10	R
EMK107BB7225□A-T			X7R	2.2 μ	±10, ±20	10	150	0.8±0.20/-0	R
LMK107 B7225□A-TR		10	X7R	2.2 μ	±10, ±20	10	150	0.8±0.10	R
JMK107 B7225□A-TR			X7R	2.2 μ	±10, ±20	10	200	0.8±0.10	R
JMK107BB7475□A-T		6.3	X7R	4.7 μ	±10, ±20	10	150	0.8±0.20/-0	R
			X7R	4.7 μ	±10, ±20	10	150	0.8±0.20/-0	R

● 212规格

【温度特性 BJ: B (-25 ~ +85°C) / X5R (-55 ~ +85°C)】 1.25mm厚度 (G)

型号1	型号2	额定电压 [V]	温度特性	静电容量 [F]	静电容量允许偏差 [%]	tanδ [%]	高温负载	厚度 <sup>3</sup> [mm]	焊接方式 R: 回流焊 W: 波峰焊
							额定电压 x %		
UMK212BBJ475□G-T		50	X5R	4.7 μ	±10, ±20	10	150	1.25±0.20/-0	R
GMK212BBJ106□G-T		35	X5R	10 μ	±10, ±20	10	150	1.25±0.20/-0	R
TMK212ABJ475□G-T	TMK212 BJ475□G-T		X5R	4.7 μ	±10, ±20	10	150	1.25±0.15/-0.05	R
TMK212BBJ106MG-T		25	X5R	10 μ	±20	10	150	1.25±0.20/-0	R
TMK212BBJ226MG-TT			X5R	22 μ	±20	10	150	1.25±0.20/-0	R
EMK212ABJ106□G-T	EMK212 BJ106□G-T		X5R	10 μ	±10, ±20	10	150	1.25±0.15/-0.05	R
EMK212BBJ226MG-T			X5R	22 μ	±20	10	150	1.25±0.20/-0	R
LMK212BBJ476MG-T		10	X5R	47 μ	±20	10	150	1.25±0.20/-0	R
JMK212BBJ476MG-T	JMK212 BJ476MG-T		X5R	47 μ	±20	10	150	1.25±0.20/-0	R
JMK212BBJ107MG-TE		6.3	X5R	100 μ	±20	20	150	1.25±0.20/-0	R
AMK212BBJ107MG-TE			X5R	100 μ	±20	20	150	1.25±0.20/-0	R
PMK212BBJ107MG-T		2.5	X5R	100 μ	±20	10	150	1.25±0.20/-0	R

【温度特性 BJ: B (-25 ~ +85°C) / X5R (-55 ~ +85°C)】 0.85mm厚度 (D)

型号1	型号2	额定电压 [V]	温度特性	静电容量 [F]	静电容量允许偏差 [%]	tanδ [%]	高温负载	厚度 <sup>3</sup> [mm]	焊接方式 R: 回流焊 W: 波峰焊	
							额定电压 x %			
UMK212ABJ105□D-T	UMK212 BJ105□D-TD	50	X5R	1 μ	±10, ±20	10	150	0.85±0.10	R	
UMK212BBJ225□D-T			X5R	2.2 μ	±10, ±20	10	150	0.85±0.10	R	
GMK212BBJ475□D-T		35	X5R	4.7 μ	±10, ±20	10	150	0.85±0.10	R	
TMK212 BJ474□D-T			B	X5R	0.47 μ	±10, ±20	3.5	200	0.85±0.10	R
TMK212 BJ105□D-T			B	X5R	1 μ	±10, ±20	5	200	0.85±0.10	R
TMK212ABJ225□D-T	TMK212 BJ225□D-T		X5R	2.2 μ	±10, ±20	5	150	0.85±0.10	R	
TMK212BBJ475□D-T	TMK212 BJ475□D-TD	25	X5R	4.7 μ	±10, ±20	10	150	0.85±0.10	R	
TMK212BBJ106□D-T			X5R	10 μ	±10, ±20	10	150	0.85±0.10	R	
EMK212 BJ105□D-T			B	X5R <sup>1</sup>	1 μ	±10, ±20	5	200	0.85±0.10	R
EMK212ABJ225□D-T	EMK212 BJ225□D-T		X5R <sup>1</sup>	2.2 μ	±10, ±20	5	200	0.85±0.10	R	
EMK212 BJ475□D-T		16	X5R	4.7 μ	±10, ±20	10	150	0.85±0.10	R	
EMK212ABJ106□D-T	EMK212 BJ106□D-TD		X5R	10 μ	±10, ±20	10	150	0.85±0.10	R	
LMK212 BJ105□D-T			B	X5R <sup>1</sup>	1 μ	±10, ±20	3.5	200	0.85±0.10	R
LMK212 BJ225□D-T			X5R <sup>1</sup>	2.2 μ	±10, ±20	5	200	0.85±0.10	R	
LMK212ABJ106□D-T	LMK212 BJ106□D-T	10	X5R	10 μ	±10, ±20	10	150	0.85±0.10	R	
LMK212BBJ226MD-T			X5R	22 μ	±20	10	150	0.85±0.10	R	
JMK212ABJ106□D-T	JMK212 BJ106□D-T		X5R	10 μ	±10, ±20	10	200	0.85±0.10	R	
JMK212ABJ226MD-T	JMK212 BJ226MD-T		X5R	22 μ	±20	10	150	0.85±0.10	R	
AMK212BBJ476MD-T		4	X5R	47 μ	±20	10	150	0.85±0.10	R	
			X5R	47 μ	±20	10	150	0.85±0.10	R	

【温度特性 C6: X6S (-55 ~ +105°C)】 1.25mm厚度 (G)

型号1	型号2	额定电压 [V]	温度特性	静电容量 [F]	静电容量允许偏差 [%]	tanδ [%]	高温负载	厚度 <sup>3</sup> [mm]	焊接方式 R: 回流焊 W: 波峰焊
							额定电压 x %		
TMK212BC6106□G-T		25	X6S	10 μ	±10, ±20	10	150	1.25±0.20/-0	R
EMK212BC6226MG-TT		16	X6S	22 μ	±20	10	150	1.25±0.20/-0	R
LMK212BC6226MG-T			X6S	22 μ	±20	10	150	1.25±0.20/-0	R
JMK212BC6226MG-T		6.3	X6S	22 μ	±20	10	150	1.25±0.20/-0	R
JMK212BC6476MG-T			X6S	47 μ	±20	10	150	1.25±0.20/-0	R
AMK212BC6476MG-T		4	X6S	47 μ	±20	10	150	1.25±0.20/-0	R
AMK212BC6107MG-TE			X6S	100 μ	±20	20	150	1.25±0.20/-0	R

▶ 由于篇幅有限, 本产品目录中只记载了有代表性的产品规格, 若考虑使用敝公司产品时, 请确认交货规格说明书中的详细规格。  
另外, 有关各产品的详细信息(特性图、可靠性信息、使用时的注意事项等), 请参阅敝公司网站 (<http://www.ty-top.com/>)。

■型号一览

【温度特性 C6 : X6S (-55 ~ +105°C)】 0.85mm厚度 (D)

型号1	型号2	额定电压 [V]	温度特性	静电容量 [F]	静电容量允许偏差 [%]	tanδ [%]	高温负载	厚度 <sup>3</sup> [mm]	焊接方式 R: 回流焊 W: 波峰焊
							额定电压 x %		
LMK212AC6106□D-T		10	X6S	10 μ	±10, ±20	10	150	0.85±0.10	R
AMK212BC6226MD-T		4	X6S	22 μ	±20	10	150	0.85±0.10	R

【温度特性 B7 : X7R (-55 ~ +125°C)】 1.25mm厚度 (G)

型号1	型号2	额定电压 [V]	温度特性	静电容量 [F]	静电容量允许偏差 [%]	tanδ [%]	高温负载	厚度 <sup>3</sup> [mm]	焊接方式 R: 回流焊 W: 波峰焊
							额定电压 x %		
UMK212 B7224□G-T		50	X7R	0.22 μ	±10, ±20	3.5	150	1.25±0.10	R/W
UMK212 B7474□G-T			X7R	0.47 μ	±10, ±20	3.5	150	1.25±0.10	R/W
UMK212 B7105□G-T			X7R	1 μ	±10, ±20	10	150	1.25±0.10	R/W
UMK212BB7225□G-T			X7R	2.2 μ	±10, ±20	10	150	1.25±0.20/-0	R
TMK212 B7225□G-TR		25	X7R	2.2 μ	±10, ±20	10	150	1.25±0.10	R
TMK212AB7475□G-T	TMK212 B7475□G-T		X7R	4.7 μ	±10, ±20	10	150	1.25±0.15/-0.05	R
EMK212 B7475□G-T		16	X7R	4.7 μ	±10, ±20	10	150	1.25±0.10	R
EMK212BB7106MG-T			X7R	10 μ	±20	10	150	1.25±0.20/-0	R
LMK212AB7106□G-T	LMK212 B7106□G-TD		10	X7R	10 μ	±10, ±20	10	150	1.25±0.15/-0.05
JMK212AB7106□G-T	JMK212 B7106□G-T	6.3	X7R	10 μ	±10, ±20	10	150	1.25±0.15/-0.05	R

【温度特性 B7 : X7R (-55 ~ +125°C)】 0.85mm厚度 (D)

型号1	型号2	额定电压 [V]	温度特性	静电容量 [F]	静电容量允许偏差 [%]	tanδ [%]	高温负载	厚度 <sup>3</sup> [mm]	焊接方式 R: 回流焊 W: 波峰焊
							额定电压 x %		
UMK212AB7104□D-T		50	X7R	0.1 μ	±10, ±20	10	150	0.85±0.10	R
UMK212AB7224□D-T			X7R	0.22 μ	±10, ±20	10	150	0.85±0.10	R
UMK212AB7474□D-T			X7R	0.47 μ	±10, ±20	10	150	0.85±0.10	R
UMK212AB7105□D-T			X7R	1 μ	±10, ±20	10	150	0.85±0.10	R
TMK212AB7225□D-TR		25	X7R	2.2 μ	±10, ±20	10	150	0.85±0.10	R
EMK212 B7474□D-T			X7R	0.47 μ	±10, ±20	3.5	200	0.85±0.10	R/W
EMK212 B7105□D-T		16	X7R	1 μ	±10, ±20	5	200	0.85±0.10	R
EMK212AB7225□D-T	EMK212 B7225□D-T		X7R	2.2 μ	±10, ±20	5	150	0.85±0.10	R
EMK212BB7475□D-T			X7R	4.7 μ	±10, ±20	10	150	0.85±0.10	R
LMK212 B7105□D-T		10	X7R	1 μ	±10, ±20	3.5	200	0.85±0.10	R
LMK212AB7225□D-T	LMK212 B7225□D-T		X7R	2.2 μ	±10, ±20	5	200	0.85±0.10	R
LMK212AB7475□D-TR	LMK212 B7475□D-TR		X7R	4.7 μ	±10, ±20	10	150	0.85±0.10	R

●316规格

【温度特性 BJ : B (-25 ~ +85°C) / X5R (-55 ~ +85°C)】 1.6mm厚度 (L)

型号1	型号2	额定电压 [V]	温度特性	静电容量 [F]	静电容量允许偏差 [%]	tanδ [%]	高温负载	厚度 <sup>3</sup> [mm]	焊接方式 R: 回流焊 W: 波峰焊
							额定电压 x %		
UMK316 BJ475□L-T		50	X5R	4.7 μ	±10, ±20	10	150	1.6±0.20	R
UMK316BBJ106□L-T			X5R	10 μ	±10, ±20	10	150	1.6±0.30	R
TMK316BBJ226ML-T		25	X5R	22 μ	±20	10	150	1.6±0.30	R
EMK316BBJ476ML-T		16	X5R	47 μ	±20	10	150	1.6±0.30	R
LMK316ABJ476ML-T	LMK316 BJ476ML-T	10	X5R	47 μ	±20	10	150	1.6±0.20	R
JMK316ABJ107ML-T	JMK316 BJ107ML-T	6.3	X5R	100 μ	±20	10	150	1.6±0.20	R
JMK316BBJ227ML-TE			X5R	220 μ	±20	20	150	1.6±0.30	R
AMK316ABJ107ML-T	AMK316 BJ107ML-T	4	X5R	100 μ	±20	10	150	1.6±0.20	R
AMK316BBJ157ML-T			X5R	150 μ	±20	10	150	1.6±0.30	R
AMK316BBJ227ML-TE			X5R	220 μ	±20	10	150	1.6±0.30	R
PMK316BBJ227ML-T		2.5	X5R	220 μ	±20	10	150	1.6±0.30	R

【温度特性 BJ : B (-25 ~ +85°C) / X5R (-55 ~ +85°C)】 0.85mm厚度 (D)

型号1	型号2	额定电压 [V]	温度特性	静电容量 [F]	静电容量允许偏差 [%]	tanδ [%]	高温负载	厚度 <sup>3</sup> [mm]	焊接方式 R: 回流焊 W: 波峰焊
							额定电压 x %		
UMK316 BJ105□D-T		50	B X5R	1 μ	±10, ±20	3.5	150	0.85±0.10	R
UMK316 BJ225□D-T			B X5R	2.2 μ	±10, ±20	3.5	150	0.85±0.10	R
UMK316ABJ475□D-T	UMK316 BJ475□D-T		X5R	4.7 μ	±10, ±20	10	150	0.85±0.10	R
TMK316 BJ105□D-T			B X5R	1 μ	±10, ±20	3.5	200	0.85±0.10	R
TMK316 BJ225□D-T		25	B X5R	2.2 μ	±10, ±20	3.5	150	0.85±0.10	R
TMK316 BJ475□D-T			X5R	4.7 μ	±10, ±20	5	150	0.85±0.10	R
TMK316ABJ106□D-T	TMK316 BJ106□D-TD		X5R	10 μ	±10, ±20	10	150	0.85±0.10	R
EMK316 BJ225□D-T			B X5R	2.2 μ	±10, ±20	3.5	200	0.85±0.10	R
EMK316 BJ475□D-T		16	B X5R	4.7 μ	±10, ±20	5	200	0.85±0.10	R
EMK316 BJ106□D-T			X5R	10 μ	±10, ±20	10	150	0.85±0.10	R
EMK316ABJ226MD-T	EMK316 BJ226MD-T		X5R	22 μ	±20	10	150	0.85±0.10	R
LMK316 BJ475□D-T		10	B X5R	4.7 μ	±10, ±20	5	200	0.85±0.10	R
LMK316 BJ106□D-T			X5R	10 μ	±10, ±20	10	200	0.85±0.10	R
LMK316ABJ226MD-T	LMK316 BJ226MD-T		X5R	22 μ	±20	10	150	0.85±0.10	R
JMK316 BJ106□D-T			X5R	10 μ	±10, ±20	10	200	0.85±0.10	R
JMK316ABJ226MD-T	JMK316 BJ226MD-T	6.3	X5R	22 μ	±20	10	150	0.85±0.10	R
JMK316ABJ476MD-T	JMK316 BJ476MD-T		X5R	47 μ	±20	10	150	0.85±0.10	R

【温度特性 C6 : X6S (-55 ~ +105°C)】 1.6mm厚度 (L)

型号1	型号2	额定电压 [V]	温度特性	静电容量 [F]	静电容量允许偏差 [%]	tanδ [%]	高温负载	厚度 <sup>3</sup> [mm]	焊接方式 R: 回流焊 W: 波峰焊
							额定电压 x %		
EMK316BC6226ML-T		16	X6S	22 μ	±20	10	150	1.6±0.30	R
LMK316BC6476ML-T		10	X6S	47 μ	±20	10	150	1.6±0.30	R
JMK316AC6476ML-T		6.3	X6S	47 μ	±20	10	150	1.6±0.20	R
AMK316AC6476ML-T		4	X6S	47 μ	±20	10	200	1.6±0.20	R
AMK316AC6107ML-T			X6S	100 μ	±20	10	150	1.6±0.20	R
AMK316BC6227ML-TE			X6S	220 μ	±20	20	150	1.6±0.30	R

▶ 由于篇幅有限, 本产品目录中只记载了有代表性的产品规格, 若考虑使用敝公司产品时, 请确认交货规格说明书中的详细规格。另外, 有关各产品的详细信息(特性图、可靠性信息、使用时的注意事项等), 请参阅敝公司网站(<http://www.ty-top.com/>)。

■ 型号一览

【温度特性 C7 : X7S (-55 ~ +125°C)】 1.6mm厚度 (L)

型号1	型号2	额定电压 [V]	温度特性	静电容量 [F]	静电容量允许偏差 [%]	tanδ [%]	高温负载	厚度 <sup>3</sup> [mm]	焊接方式 R: 回流焊 W: 波峰焊
							额定电压 x %		
JMK316AC7476ML-T		6.3	X7S	47 μ	±20	10	150	1.6±0.20	R
AMK316AC7476ML-T		4	X7S	47 μ	±20	10	150	1.6±0.20	R

【温度特性 B7 : X7R (-55 ~ +125°C)】 1.6mm厚度 (L)

型号1	型号2	额定电压 [V]	温度特性	静电容量 [F]	静电容量允许偏差 [%]	tanδ [%]	高温负载	厚度 <sup>3</sup> [mm]	焊接方式 R: 回流焊 W: 波峰焊
							额定电压 x %		
UMK316 B7225□L-T		50	X7R	2.2 μ	±10, ±20	10	150	1.6±0.20	R
UMK316AB7475□L-T	UMK316 B7475□L-T		X7R	4.7 μ	±10, ±20	10	150	1.6±0.20	R
GMK316AB7106□L-TR		35	X7R	10 μ	±10, ±20	10	150	1.6±0.20	R
TMK316AB7475□L-T	TMK316 B7475□L-T		X7R	4.7 μ	±10, ±20	10	200	1.6±0.20	R
TMK316AB7106□L-T	TMK316 B7106□L-TD	25	X7R	10 μ	±10, ±20	10	150	1.6±0.20	R
EMK316 B7475□L-T			X7R	4.7 μ	±10, ±20	5	200	1.6±0.20	R
EMK316AB7106□L-T	EMK316 B7106□L-TD	16	X7R	10 μ	±10, ±20	10	200	1.6±0.20	R
EMK316BB7226ML-T			X7R	22 μ	±20	10	150	1.6±0.30	R
LMK316AB7106□L-T	LMK316 B7106□L-TD	10	X7R	10 μ	±10, ±20	10	200	1.6±0.20	R
LMK316AB7226□L-TR	LMK316 B7226□L-TD		X7R	22 μ	±10, ±20	10	150	1.6±0.20	R

【温度特性 B7 : X7R (-55 ~ +125°C)】 0.85mm厚度 (D)

型号1	型号2	额定电压 [V]	温度特性	静电容量 [F]	静电容量允许偏差 [%]	tanδ [%]	高温负载	厚度 <sup>3</sup> [mm]	焊接方式 R: 回流焊 W: 波峰焊
							额定电压 x %		
UMK316 B7225□D-T		50	X7R	2.2 μ	±10, ±20	10	150	0.85±0.10	R
TMK316AB7475□D-T		25	X7R	4.7 μ	±10, ±20	10	150	0.85±0.10	R
LMK316AB7106MD-T		10	X7R	10 μ	±20	10	150	0.85±0.10	R

● 325规格

【温度特性 BJ : B (-25 ~ +85°C) / X5R (-55 ~ +85°C)】 2.5mm厚度 (M)

型号1	型号2	额定电压 [V]	温度特性	静电容量 [F]	静电容量允许偏差 [%]	tanδ [%]	高温负载	厚度 <sup>3</sup> [mm]	焊接方式 R: 回流焊 W: 波峰焊
							额定电压 x %		
UMK325 BJ106□M-P		50	X5R	10 μ	±10, ±20	5	150	2.5±0.20	R
GMK325 BJ226MM-P		35	X5R	22 μ	±20	5	150	2.5±0.20	R
TMK325ABJ476MM-P		25	X5R	47 μ	±20	10	150	2.5±0.30	R
EMK325ABJ107MM-P		16	X5R	100 μ	±20	10	150	2.5±0.30	R
LMK325 BJ476MM-P		10	X5R	47 μ	±20	10	150	2.5±0.20	R
LMK325ABJ107MM-P	LMK325 BJ107MM-P		X5R	100 μ	±20	10	150	2.5±0.30	R
JMK325ABJ157MM-P		6.3	X5R	150 μ	±20	10	150	2.5±0.30	R
JMK325ABJ227MM-P			X5R	220 μ	±20	10	150	2.5±0.30	R
JMK325ABJ337MM-PE			X5R	330 μ	±20	10	150	2.5±0.30	R
AMK325ABJ157MM-P			X5R	150 μ	±20	10	150	2.5±0.30	R
AMK325ABJ227MM-P		4	X5R	220 μ	±20	10	150	2.5±0.30	R
AMK325ABJ337MM-P			X5R	330 μ	±20	10	150	2.5±0.30	R

【温度特性 BJ : B (-25 ~ +85°C) / X5R (-55 ~ +85°C)】 1.9mm厚度 (Y,N)

型号1	型号2	额定电压 [V]	温度特性	静电容量 [F]	静电容量允许偏差 [%]	tanδ [%]	高温负载	厚度 <sup>3</sup> [mm]	焊接方式 R: 回流焊 W: 波峰焊	
							额定电压 x %			
UMK325 BJ475□N-T		50	X5R	4.7 μ	±10, ±20	10	150	1.9±0.20	R	
GMK325 BJ225□N-T		35	B	X5R	2.2 μ	±10, ±20	3.5	200	1.9±0.20	R
GMK325 BJ475□N-T			X5R	4.7 μ	±10, ±20	10	150	1.9±0.20	R	
GMK325 BJ106□N-T		25	X5R	10 μ	±10, ±20	5	150	1.9±0.20	R	
TMK325 BJ335MN-T			B	X5R <sup>1</sup>	3.3 μ	±20	3.5	200	1.9±0.20	R
TMK325 BJ475□N-T			B	X5R <sup>1</sup>	4.7 μ	±10, ±20	3.5	200	1.9±0.20	R
TMK325 BJ106□N-T			X5R	10 μ	±10, ±20	5	200	1.9±0.20	R	
EMK325 BJ475□N-T		16	B	X5R <sup>1</sup>	4.7 μ	±10, ±20	3.5	200	1.9±0.20	R
EMK325 BJ106□N-T			X5R	10 μ	±10, ±20	3.5	200	1.9±0.20	R	
EMK325 BJ476MY-T		10	X5R	47 μ	±20	10	150	1.9±0.1/-0.2	R	
LMK325 BJ226MY-T			B	X5R	22 μ	±20	5	150	1.9±0.1/-0.2	R
LMK325 BJ106□N-T			X5R	10 μ	±10, ±20	3.5	200	1.9±0.20	R	
JMK325 BJ226MY-T			B	X5R	22 μ	±20	5	200	1.9±0.1/-0.2	R
JMK325 BJ107MY-T		6.3	X5R	100 μ	±20	10	150	1.9±0.1/-0.2	R	
JMK325 BJ476MN-T			X5R	47 μ	±20	10	150	1.9±0.20	R	

【温度特性 BJ : B (-25 ~ +85°C) / X5R (-55 ~ +85°C)】 0.85mm厚度 (D)

型号1	型号2	额定电压 [V]	温度特性	静电容量 [F]	静电容量允许偏差 [%]	tanδ [%]	高温负载	厚度 <sup>3</sup> [mm]	焊接方式 R: 回流焊 W: 波峰焊	
							额定电压 x %			
TMK325 BJ106□D-T		25	X5R	10 μ	±10, ±20	5	150	0.85±0.10	R	
EMK325 BJ106□D-T		16	X5R	10 μ	±10, ±20	5	150	0.85±0.10	R	
EMK325 BJ226MD-T			X5R	22 μ	±20	10	150	0.85±0.10	R	
LMK325 BJ335□D-T		10	B	X5R	3.3 μ	±10, ±20	3.5	200	0.85±0.10	R
LMK325 BJ475□D-T			B	X5R	4.7 μ	±10, ±20	5	200	0.85±0.10	R
LMK325 BJ106□D-T			X5R	10 μ	±10, ±20	5	150	0.85±0.10	R	

【温度特性 C6 : X6S (-55 ~ +105°C)】 2.5mm厚度 (M)

型号1	型号2	额定电压 [V]	温度特性	静电容量 [F]	静电容量允许偏差 [%]	tanδ [%]	高温负载	厚度 <sup>3</sup> [mm]	焊接方式 R: 回流焊 W: 波峰焊
							额定电压 x %		
EMK325AC6476MM-P		16	X6S	47 μ	±20	10	150	2.5±0.30	R
LMK325AC6107MM-P		10	X6S	100 μ	±20	10	150	2.5±0.30	R
AMK325AC6157MM-P			X6S	150 μ	±20	10	150	2.5±0.30	R
AMK325AC6227MM-P		4	X6S	220 μ	±20	10	150	2.5±0.30	R
AMK325AC6337MM-PE			X6S	330 μ	±20	10	150	2.5±0.30	R
PMK325AC6337MM-P		2.5	X6S	330 μ	±20	10	150	2.5±0.30	R

▶ 由于篇幅有限, 本产品目录中只记载了有代表性的产品规格, 若考虑使用敝公司产品时, 请确认交货规格说明书中的详细规格。另外, 有关各产品的详细信息(特性图、可靠性信息、使用时的注意事项等), 请参阅敝公司网站 (<http://www.ty-top.com/>)。

■型号一览

【温度特性 C7 : X7S (-55 ~ +125°C)】 2.5mm厚度 (M)

型号1	型号2	额定电压 [V]	温度特性	静电容量 [F]	静电容量允许偏差 [%]	tanδ [%]	高温负载	厚度 <sup>3</sup> [mm]	焊接方式 R: 回流焊 W: 波峰焊
							额定电压 x %		
JMK325AC7107MM-P		6.3	X7S	100 μ	±20	10	150	2.5±0.30	R

【温度特性 B7 : X7R (-55 ~ +125°C)】 2.5mm厚度 (M)

型号1	型号2	额定电压 [V]	温度特性	静电容量 [F]	静电容量允许偏差 [%]	tanδ [%]	高温负载	厚度 <sup>3</sup> [mm]	焊接方式 R: 回流焊 W: 波峰焊
							额定电压 x %		
UMK325 B7335□M-P		50	X7R	3.3 μ	±10, ±20	3.5	200	2.5±0.20	R
UMK325 B7475□M-P			X7R	4.7 μ	±10, ±20	5	150	2.5±0.20	R
UMK325AB7106□M-P			X7R	10 μ	±10, ±20	10	150	2.5±0.30	R
TMK325AB7106□M-P		25	X7R	10 μ	±10, ±20	10	200	2.5±0.30	R
TMK325 B7226□M-PR			X7R	22 μ	±10, ±20	10	150	2.5±0.20	R
EMK325 B7226□M-PR		16	X7R	22 μ	±10, ±20	10	150	2.5±0.20	R
LMK325 B7476□M-PR		10	X7R	47 μ	±10, ±20	10	150	2.5±0.20	R
JMK325 B7476□M-PR		6.3	X7R	47 μ	±10, ±20	10	200	2.5±0.20	R

【温度特性 B7 : X7R (-55 ~ +125°C)】 1.9mm厚度 (N)

型号1	型号2	额定电压 [V]	温度特性	静电容量 [F]	静电容量允许偏差 [%]	tanδ [%]	高温负载	厚度 <sup>3</sup> [mm]	焊接方式 R: 回流焊 W: 波峰焊
							额定电压 x %		
UMK325 B7475□N-TR		50	X7R	4.7 μ	±10, ±20	10	150	1.9±0.20	R
TMK325 B7335□N-T		25	X7R	3.3 μ	±10, ±20	3.5	200	1.9±0.20	R
TMK325 B7475□N-T			X7R	4.7 μ	±10, ±20	3.5	150	1.9±0.20	R
TMK325 B7106□N-TR			X7R	10 μ	±10, ±20	10	150	1.9±0.20	R
EMK325 B7475□N-T		16	X7R	4.7 μ	±10, ±20	3.5	200	1.9±0.20	R
EMK325 B7106□N-T			X7R	10 μ	±10, ±20	3.5	150	1.9±0.20	R
LMK325 B7106□N-T		10	X7R	10 μ	±10, ±20	3.5	200	1.9±0.20	R

●432规格

【温度特性 BJ : X5R (-55 ~ +85°C)】 2.5mm厚度 (M)

型号1	型号2	额定电压 [V]	温度特性	静电容量 [F]	静电容量允许偏差 [%]	tanδ [%]	高温负载	厚度 <sup>3</sup> [mm]	焊接方式 R: 回流焊 W: 波峰焊
							额定电压 x %		
AMK432 BJ477MM-T		4	X5R	470 μ	±20	10	150	2.5±0.20	R

【温度特性 C6 : X6S (-55 ~ +105°C)】 2.5mm厚度 (M)

型号1	型号2	额定电压 [V]	温度特性	静电容量 [F]	静电容量允许偏差 [%]	tanδ [%]	高温负载	厚度 <sup>3</sup> [mm]	焊接方式 R: 回流焊 W: 波峰焊
							额定电压 x %		
PMK432 C6477MM-T		2.5	X6S	470 μ	±20	10	150	2.5±0.20	R

▶由于篇幅有限,本产品目录中只记载了有代表性的产品规格,若考虑使用敝公司产品时,请确认交货规格说明书中的详细规格。另外,有关各产品的详细信息(特性图、可靠性信息、使用时的注意事项等),请参阅敝公司网站(<http://www.ty-top.com/>)。

多层陶瓷电容器 (温度补偿用)

● 021规格

【温度特性  $C\Delta : C\Delta/C0\Delta (-55 \sim +125^\circ\text{C})$ 】 0.125mm厚度 (K)

Table with columns: 型号1, 型号2, 额定电压 [V], 温度特性, 静电容量 [F], 静电容量允许偏差, Q值 (at 1MHz) (min), 高温负载 (额定电压 x %), 厚度³ [mm], 焊接方式. Lists various capacitor models like TMK021 CK0R2K-K-W, etc.

陶瓷电容器

多层陶瓷电容器

由于篇幅有限, 本产品目录中只记载了有代表性的产品规格, 若考虑使用敝公司产品时, 请确认交货规格说明书中的详细规格。另外, 有关各产品的详细信息 (特性图、可靠性信息、使用时的注意事项等), 请参阅敝公司网站 (http://www.ty-top.com/)。



型号1	型号2	额定电压 [V]	温度特性	静电容量 [F]	静电容量允许偏差	Q值 (at 1MHz) (min)	高温负载	厚度 <sup>-3</sup> [mm]	焊接方式 R: 回流焊 W: 波峰焊
							额定电压 x %		
TMK042 CH5R9[D-W]		25	CH C0H	5.9 p	±0.1pF, ±0.25pF, ±0.5pF	518	200	0.2±0.02	R
TMK042 CH060[D-W]			CH C0H	6 p	±0.1pF, ±0.25pF, ±0.5pF	520	200	0.2±0.02	R
TMK042 CH6R1[D-W]			CH C0H	6.1 p	±0.1pF, ±0.25pF, ±0.5pF	522	200	0.2±0.02	R
TMK042 CH6R2[D-W]			CH C0H	6.2 p	±0.1pF, ±0.25pF, ±0.5pF	524	200	0.2±0.02	R
TMK042 CH6R3[D-W]			CH C0H	6.3 p	±0.1pF, ±0.25pF, ±0.5pF	526	200	0.2±0.02	R
TMK042 CH6R4[D-W]			CH C0H	6.4 p	±0.1pF, ±0.25pF, ±0.5pF	528	200	0.2±0.02	R
TMK042 CH6R5[D-W]			CH C0H	6.5 p	±0.1pF, ±0.25pF, ±0.5pF	530	200	0.2±0.02	R
TMK042 CH6R6[D-W]			CH C0H	6.6 p	±0.1pF, ±0.25pF, ±0.5pF	532	200	0.2±0.02	R
TMK042 CH6R7[D-W]			CH C0H	6.7 p	±0.1pF, ±0.25pF, ±0.5pF	534	200	0.2±0.02	R
TMK042 CH6R8[D-W]			CH C0H	6.8 p	±0.1pF, ±0.25pF, ±0.5pF	536	200	0.2±0.02	R
TMK042 CH6R9[D-W]			CH C0H	6.9 p	±0.1pF, ±0.25pF, ±0.5pF	538	200	0.2±0.02	R
TMK042 CH070[D-W]			CH C0H	7 p	±0.1pF, ±0.25pF, ±0.5pF	540	200	0.2±0.02	R
TMK042 CH7R1[D-W]			CH C0H	7.1 p	±0.1pF, ±0.25pF, ±0.5pF	542	200	0.2±0.02	R
TMK042 CH7R2[D-W]			CH C0H	7.2 p	±0.1pF, ±0.25pF, ±0.5pF	544	200	0.2±0.02	R
TMK042 CH7R3[D-W]			CH C0H	7.3 p	±0.1pF, ±0.25pF, ±0.5pF	546	200	0.2±0.02	R
TMK042 CH7R4[D-W]			CH C0H	7.4 p	±0.1pF, ±0.25pF, ±0.5pF	548	200	0.2±0.02	R
TMK042 CH7R5[D-W]			CH C0H	7.5 p	±0.1pF, ±0.25pF, ±0.5pF	550	200	0.2±0.02	R
TMK042 CH7R6[D-W]			CH C0H	7.6 p	±0.1pF, ±0.25pF, ±0.5pF	552	200	0.2±0.02	R
TMK042 CH7R7[D-W]			CH C0H	7.7 p	±0.1pF, ±0.25pF, ±0.5pF	554	200	0.2±0.02	R
TMK042 CH7R8[D-W]			CH C0H	7.8 p	±0.1pF, ±0.25pF, ±0.5pF	556	200	0.2±0.02	R
TMK042 CH7R9[D-W]			CH C0H	7.9 p	±0.1pF, ±0.25pF, ±0.5pF	558	200	0.2±0.02	R
TMK042 CH080[D-W]			CH C0H	8 p	±0.1pF, ±0.25pF, ±0.5pF	560	200	0.2±0.02	R
TMK042 CH8R1[D-W]			CH C0H	8.1 p	±0.1pF, ±0.25pF, ±0.5pF	562	200	0.2±0.02	R
TMK042 CH8R2[D-W]			CH C0H	8.2 p	±0.1pF, ±0.25pF, ±0.5pF	564	200	0.2±0.02	R
TMK042 CH8R3[D-W]			CH C0H	8.3 p	±0.1pF, ±0.25pF, ±0.5pF	566	200	0.2±0.02	R
TMK042 CH8R4[D-W]			CH C0H	8.4 p	±0.1pF, ±0.25pF, ±0.5pF	568	200	0.2±0.02	R
TMK042 CH8R5[D-W]			CH C0H	8.5 p	±0.1pF, ±0.25pF, ±0.5pF	570	200	0.2±0.02	R
TMK042 CH8R6[D-W]			CH C0H	8.6 p	±0.1pF, ±0.25pF, ±0.5pF	572	200	0.2±0.02	R
TMK042 CH8R7[D-W]			CH C0H	8.7 p	±0.1pF, ±0.25pF, ±0.5pF	574	200	0.2±0.02	R
TMK042 CH8R8[D-W]			CH C0H	8.8 p	±0.1pF, ±0.25pF, ±0.5pF	576	200	0.2±0.02	R
TMK042 CH8R9[D-W]			CH C0H	8.9 p	±0.1pF, ±0.25pF, ±0.5pF	578	200	0.2±0.02	R
TMK042 CH090[D-W]			CH C0H	9 p	±0.1pF, ±0.25pF, ±0.5pF	580	200	0.2±0.02	R
TMK042 CH9R1[D-W]			CH C0H	9.1 p	±0.1pF, ±0.25pF, ±0.5pF	582	200	0.2±0.02	R
TMK042 CH9R2[D-W]			CH C0H	9.2 p	±0.1pF, ±0.25pF, ±0.5pF	584	200	0.2±0.02	R
TMK042 CH9R3[D-W]			CH C0H	9.3 p	±0.1pF, ±0.25pF, ±0.5pF	586	200	0.2±0.02	R
TMK042 CH9R4[D-W]			CH C0H	9.4 p	±0.1pF, ±0.25pF, ±0.5pF	588	200	0.2±0.02	R
TMK042 CH9R5[D-W]			CH C0H	9.5 p	±0.1pF, ±0.25pF, ±0.5pF	590	200	0.2±0.02	R
TMK042 CH9R6[D-W]			CH C0H	9.6 p	±0.1pF, ±0.25pF, ±0.5pF	592	200	0.2±0.02	R
TMK042 CH9R7[D-W]			CH C0H	9.7 p	±0.1pF, ±0.25pF, ±0.5pF	594	200	0.2±0.02	R
TMK042 CH9R8[D-W]			CH C0H	9.8 p	±0.1pF, ±0.25pF, ±0.5pF	596	200	0.2±0.02	R
TMK042 CH9R9[D-W]			CH C0H	9.9 p	±0.1pF, ±0.25pF, ±0.5pF	598	200	0.2±0.02	R
TMK042 CH100DD-W			CH C0H	10 p	±0.5pF	600	200	0.2±0.02	R
TMK042 CH110JD-W			CH C0H	11 p	±5%	620	200	0.2±0.02	R
TMK042 CH120JD-W			CH C0H	12 p	±5%	640	200	0.2±0.02	R
TMK042 CH130JD-W			CH C0H	13 p	±5%	660	200	0.2±0.02	R
TMK042 CH150JD-W			CH C0H	15 p	±5%	700	200	0.2±0.02	R
TMK042 CH160JC-W			CH C0H	16 p	±5%	720	200	0.2±0.02	R
TMK042 CH180JC-W			CH C0H	18 p	±5%	760	200	0.2±0.02	R
TMK042 CH200JC-W			CH C0H	20 p	±5%	800	200	0.2±0.02	R
TMK042 CH220JC-W			CH C0H	22 p	±5%	840	200	0.2±0.02	R
TMK042 CH240JC-W			CH C0H	24 p	±5%	880	200	0.2±0.02	R
TMK042 CH270JC-W			CH C0H	27 p	±5%	940	200	0.2±0.02	R
TMK042 CH300JC-W			CH C0H	30 p	±5%	1000	200	0.2±0.02	R
TMK042 CH330JC-W			CH C0H	33 p	±5%	1000	200	0.2±0.02	R
TMK042 CH360JC-W			CH C0H	36 p	±5%	1000	200	0.2±0.02	R
TMK042 CH390JC-W			CH C0H	39 p	±5%	1000	200	0.2±0.02	R
TMK042 CH430JC-W			CH C0H	43 p	±5%	1000	200	0.2±0.02	R
TMK042 CH470JC-W			CH C0H	47 p	±5%	1000	200	0.2±0.02	R
TMK042 CH510JC-W			CH C0H	51 p	±5%	1000	200	0.2±0.02	R
TMK042 CH560JC-W			CH C0H	56 p	±5%	1000	200	0.2±0.02	R
TMK042 CH620JC-W			CH C0H	62 p	±5%	1000	200	0.2±0.02	R
TMK042 CH680JC-W			CH C0H	68 p	±5%	1000	200	0.2±0.02	R
TMK042 CH750JC-W			CH C0H	75 p	±5%	1000	200	0.2±0.02	R
TMK042 CH820JC-W			CH C0H	82 p	±5%	1000	200	0.2±0.02	R
TMK042 CH910JC-W			CH C0H	91 p	±5%	1000	200	0.2±0.02	R
TMK042 CH101JC-W			CH C0H	100 p	±5%	1000	200	0.2±0.02	R

▶ 由于篇幅有限, 本产品目录中只记载了有代表性的产品规格, 若考虑使用敝公司产品时, 请确认交货规格说明书中的详细规格。另外, 有关各产品的详细信息(特性图、可靠性信息、使用时的注意事项等), 请参阅敝公司网站 (<http://www.ty-top.com/>)。





■ 型号一览

型号1	型号2	额定电压 [V]	温度特性		静电容量 [F]	静电容量允许偏差	Q值 (at 1MHz) (min)	高温负载	厚度 <sup>3</sup> [mm]	焊接方式 R: 回流焊 W: 波峰焊
								额定电压 x %		
EMK042 CH9R1□D-W		16	CH	C0H	9.1 p	±0.1pF, ±0.25pF, ±0.5pF	582	200	0.2±0.02	R
EMK042 CH9R2□D-W			CH	C0H	9.2 p	±0.1pF, ±0.25pF, ±0.5pF	584	200	0.2±0.02	R
EMK042 CH9R3□D-W			CH	C0H	9.3 p	±0.1pF, ±0.25pF, ±0.5pF	586	200	0.2±0.02	R
EMK042 CH9R4□D-W			CH	C0H	9.4 p	±0.1pF, ±0.25pF, ±0.5pF	588	200	0.2±0.02	R
EMK042 CH9R5□D-W			CH	C0H	9.5 p	±0.1pF, ±0.25pF, ±0.5pF	590	200	0.2±0.02	R
EMK042 CH9R6□D-W			CH	C0H	9.6 p	±0.1pF, ±0.25pF, ±0.5pF	592	200	0.2±0.02	R
EMK042 CH9R7□D-W			CH	C0H	9.7 p	±0.1pF, ±0.25pF, ±0.5pF	594	200	0.2±0.02	R
EMK042 CH9R8□D-W			CH	C0H	9.8 p	±0.1pF, ±0.25pF, ±0.5pF	596	200	0.2±0.02	R
EMK042 CH9R9□D-W			CH	C0H	9.9 p	±0.1pF, ±0.25pF, ±0.5pF	598	200	0.2±0.02	R
EMK042 CH100DD-W			CH	C0H	10 p	±0.5pF	600	200	0.2±0.02	R
EMK042 CH110JD-W			CH	C0H	11 p	±5%	620	200	0.2±0.02	R
EMK042 CH120JD-W			CH	C0H	12 p	±5%	640	200	0.2±0.02	R
EMK042 CH130JD-W			CH	C0H	13 p	±5%	660	200	0.2±0.02	R
EMK042 CH150JD-W			CH	C0H	15 p	±5%	700	200	0.2±0.02	R
EMK042 CH160JC-W			CH	C0H	16 p	±5%	720	200	0.2±0.02	R
EMK042 CH180JC-W			CH	C0H	18 p	±5%	760	200	0.2±0.02	R
EMK042 CH200JC-W			CH	C0H	20 p	±5%	800	200	0.2±0.02	R
EMK042 CH220JC-W			CH	C0H	22 p	±5%	840	200	0.2±0.02	R
EMK042 CH240JC-W			CH	C0H	24 p	±5%	880	200	0.2±0.02	R
EMK042 CH270JC-W			CH	C0H	27 p	±5%	940	200	0.2±0.02	R
EMK042 CH300JC-W			CH	C0H	30 p	±5%	1000	200	0.2±0.02	R
EMK042 CH330JC-W			CH	C0H	33 p	±5%	1000	200	0.2±0.02	R
EMK042 CH360JC-W			CH	C0H	36 p	±5%	1000	200	0.2±0.02	R
EMK042 CH390JC-W			CH	C0H	39 p	±5%	1000	200	0.2±0.02	R
EMK042 CH430JC-W			CH	C0H	43 p	±5%	1000	200	0.2±0.02	R
EMK042 CH470JC-W			CH	C0H	47 p	±5%	1000	200	0.2±0.02	R
EMK042 CH510JC-W			CH	C0H	51 p	±5%	1000	200	0.2±0.02	R
EMK042 CH560JC-W			CH	C0H	56 p	±5%	1000	200	0.2±0.02	R
EMK042 CH620JC-W			CH	C0H	62 p	±5%	1000	200	0.2±0.02	R
EMK042 CH680JC-W			CH	C0H	68 p	±5%	1000	200	0.2±0.02	R
EMK042 CH750JC-W			CH	C0H	75 p	±5%	1000	200	0.2±0.02	R
EMK042 CH820JC-W			CH	C0H	82 p	±5%	1000	200	0.2±0.02	R
EMK042 CH910JC-W			CH	C0H	91 p	±5%	1000	200	0.2±0.02	R
EMK042 CH101JC-W			CH	C0H	100 p	±5%	1000	200	0.2±0.02	R
EMK042 CH221JC-W			CH	C0H	220 p	±5%	1000	200	0.2±0.02	R
EMK042 CH241JC-W			CH	C0H	240 p	±5%	1000	200	0.2±0.02	R
EMK042 CH271JC-W			CH	C0H	270 p	±5%	1000	200	0.2±0.02	R
EMK042 CH331JC-W			CH	C0H	330 p	±5%	1000	200	0.2±0.02	R

● 063规格

【温度特性 CΔ : CΔ/C0Δ (-55 ~ +125°C)】 0.3mm厚度 (T)

型号1	型号2	额定电压 [V]	温度特性		静电容量 [F]	静电容量允许偏差	Q值 (at 1MHz) (min)	高温负载	厚度 <sup>3</sup> [mm]	焊接方式 R: 回流焊 W: 波峰焊
								额定电压 x %		
UMK063 CH200JT-F		50	CH	C0H	20 p	±5%	800	200	0.3±0.03	R
UMK063 CH220JT-F			CH	C0H	22 p	±5%	840	200	0.3±0.03	R
UMK063 CH240JT-F			CH	C0H	24 p	±5%	880	200	0.3±0.03	R
UMK063 CH270JT-F			CH	C0H	27 p	±5%	940	200	0.3±0.03	R
UMK063 CH300JT-F			CH	C0H	30 p	±5%	1000	200	0.3±0.03	R
UMK063 CH330JT-F			CH	C0H	33 p	±5%	1000	200	0.3±0.03	R
UMK063 CH360JT-F			CH	C0H	36 p	±5%	1000	200	0.3±0.03	R
UMK063 CH390JT-F			CH	C0H	39 p	±5%	1000	200	0.3±0.03	R
UMK063 CH430JT-F			CH	C0H	43 p	±5%	1000	200	0.3±0.03	R
UMK063 CH470JT-F			CH	C0H	47 p	±5%	1000	200	0.3±0.03	R
UMK063 CH510JT-F			CH	C0H	51 p	±5%	1000	200	0.3±0.03	R
UMK063 CH560JT-F			CH	C0H	56 p	±5%	1000	200	0.3±0.03	R
UMK063 CH620JT-F			CH	C0H	62 p	±5%	1000	200	0.3±0.03	R
UMK063 CH680JT-F			CH	C0H	68 p	±5%	1000	200	0.3±0.03	R
UMK063 CH750JT-F			CH	C0H	75 p	±5%	1000	200	0.3±0.03	R
UMK063 CH820JT-F			CH	C0H	82 p	±5%	1000	200	0.3±0.03	R
UMK063 CH910JT-F			CH	C0H	91 p	±5%	1000	200	0.3±0.03	R
UMK063 CH101JT-F			CH	C0H	100 p	±5%	1000	200	0.3±0.03	R
UMK063 CH111JT-F			CH	C0H	110 p	±5%	1000	200	0.3±0.03	R
UMK063 CH121JT-F			CH	C0H	120 p	±5%	1000	200	0.3±0.03	R
UMK063 CH131JT-F			CH	C0H	130 p	±5%	1000	200	0.3±0.03	R
UMK063 CH151JT-F			CH	C0H	150 p	±5%	1000	200	0.3±0.03	R
UMK063 CH181JT-F			CH	C0H	180 p	±5%	1000	200	0.3±0.03	R
UMK063 CH201JT-F			CH	C0H	200 p	±5%	1000	200	0.3±0.03	R
UMK063 CH221JT-F			CH	C0H	220 p	±5%	1000	200	0.3±0.03	R
TMK063 CH241JT-F			CH	C0H	240 p	±5%	1000	200	0.3±0.03	R
TMK063 CH271JT-F			CH	C0H	270 p	±5%	1000	200	0.3±0.03	R
TMK063 CH301JT-F			CH	C0H	300 p	±5%	1000	200	0.3±0.03	R
TMK063 CH331JT-F			CH	C0H	330 p	±5%	1000	200	0.3±0.03	R
TMK063 CH361JT-F			CH	C0H	360 p	±5%	1000	200	0.3±0.03	R
TMK063 CH391JT-F			CH	C0H	390 p	±5%	1000	200	0.3±0.03	R
TMK063 CH431JT-F			CH	C0H	430 p	±5%	1000	200	0.3±0.03	R
TMK063 CH471JT-F			CH	C0H	470 p	±5%	1000	200	0.3±0.03	R
TMK063 CH511JT-F			CH	C0H	510 p	±5%	1000	200	0.3±0.03	R
TMK063 CH561JT-F			CH	C0H	560 p	±5%	1000	200	0.3±0.03	R
TMK063 CH621JT-F			CH	C0H	620 p	±5%	1000	200	0.3±0.03	R
TMK063 CH681JT-F			CH	C0H	680 p	±5%	1000	200	0.3±0.03	R
TMK063 CH751JT-F			CH	C0H	750 p	±5%	1000	200	0.3±0.03	R
TMK063 CH821JT-F			CH	C0H	820 p	±5%	1000	200	0.3±0.03	R
TMK063 CH911JT-F			CH	C0H	910 p	±5%	1000	200	0.3±0.03	R
TMK063 CH102JT-F			CH	C0H	1000 p	±5%	1000	200	0.3±0.03	R

▶ 由于篇幅有限, 本产品目录中只记载了有代表性的产品规格, 若考虑使用敝公司产品时, 请确认交货规格说明书中的详细规格。另外, 有关各产品的详细信息(特性图、可靠性信息、使用时的注意事项等), 请参阅敝公司网站 (<http://www.ty-top.com/>)。

● 105规格  
 【温度特性 UΔ : UΔ/U2Δ (-55 ~ +125°C)】 0.5mm厚度 (V)

型号1	型号2	额定电压 [V]	温度特性		静电容量 [F]	静电容量允许偏差	Q值 (at 1MHz) (min)	高温负载	厚度 <sup>3</sup> [mm]	焊接方式 R: 回流焊 W: 波峰焊
								额定电压 x %		
UMK105 UK0R5CV-F		50	UK	U2K	0.5 p	±0.25pF	410	200	0.5±0.05	R
UMK105 UK010CV-F			UK	U2K	1 p	±0.25pF	420	200	0.5±0.05	R
UMK105 UK1R5CV-F			UK	U2K	1.5 p	±0.25pF	430	200	0.5±0.05	R
UMK105 UK020CV-F			UK	U2K	2 p	±0.25pF	440	200	0.5±0.05	R
UMK105 UK030CV-F			UK	U2K	3 p	±0.25pF	460	200	0.5±0.05	R
UMK105 UJ040CV-F			UJ	U2J	4 p	±0.25pF	480	200	0.5±0.05	R
UMK105 UJ050CV-F			UJ	U2J	5 p	±0.25pF	500	200	0.5±0.05	R
UMK105 UJ060DV-F			UJ	U2J	6 p	±0.5pF	520	200	0.5±0.05	R
UMK105 UJ070DV-F			UJ	U2J	7 p	±0.5pF	540	200	0.5±0.05	R
UMK105 UJ080DV-F			UJ	U2J	8 p	±0.5pF	560	200	0.5±0.05	R
UMK105 UJ090DV-F			UJ	U2J	9 p	±0.5pF	580	200	0.5±0.05	R
UMK105 UJ100DV-F			UJ	U2J	10 p	±0.5pF	600	200	0.5±0.05	R
UMK105 UJ120JV-F			UJ	U2J	12 p	±5%	640	200	0.5±0.05	R
UMK105 UJ150JV-F			UJ	U2J	15 p	±5%	700	200	0.5±0.05	R
UMK105 UJ180JV-F			UJ	U2J	18 p	±5%	760	200	0.5±0.05	R
UMK105 UJ220JV-F			UJ	U2J	22 p	±5%	840	200	0.5±0.05	R
UMK105 UJ270JV-F			UJ	U2J	27 p	±5%	940	200	0.5±0.05	R
UMK105 UJ330JV-F			UJ	U2J	33 p	±5%	1000	200	0.5±0.05	R
UMK105 UJ390JV-F			UJ	U2J	39 p	±5%	1000	200	0.5±0.05	R
UMK105 UJ470JV-F			UJ	U2J	47 p	±5%	1000	200	0.5±0.05	R
UMK105 UJ560JV-F			UJ	U2J	56 p	±5%	1000	200	0.5±0.05	R
UMK105 UJ680JV-F			UJ	U2J	68 p	±5%	1000	200	0.5±0.05	R
UMK105 UJ820JV-F			UJ	U2J	82 p	±5%	1000	200	0.5±0.05	R
UMK105 UJ101JV-F			UJ	U2J	100 p	±5%	1000	200	0.5±0.05	R
UMK105 UJ121JV-F			UJ	U2J	120 p	±5%	1000	200	0.5±0.05	R
UMK105 UJ151JV-F			UJ	U2J	150 p	±5%	1000	200	0.5±0.05	R
UMK105 UJ181JV-F			UJ	U2J	180 p	±5%	1000	200	0.5±0.05	R
UMK105 UJ221JV-F			UJ	U2J	220 p	±5%	1000	200	0.5±0.05	R
UMK105 UJ271JV-F			UJ	U2J	270 p	±5%	1000	200	0.5±0.05	R
UMK105 UJ331JV-F			UJ	U2J	330 p	±5%	1000	200	0.5±0.05	R

多面陶瓷电容器

▶ 由于篇幅有限，本产品目录中只记载了有代表性的产品规格，若考虑使用贵公司产品时，请确认交货规格说明书中的详细规格。另外，有关各产品的详细信息(特性图、可靠性信息、使用时的注意事项等)，请参阅贵公司网站(<http://www.ty-top.com/>)。

高频多层陶瓷电容器

●021规格

【温度特性 CH: CH/COH (-55 ~ +125°C)】 0.125mm厚度 (K)

型号1	型号2	额定电压 [V]	温度特性		静电容量 [F]	静电容量允许偏差	Q值 (at 1GHz) (min)	高温负载	厚度 <sup>3</sup> [mm]	焊接方式 R: 回流焊 W: 波峰焊
								额定电压 x %		
TVS021 CH0R2□K-W		25	CH	COH	0.2 p	±0.05pF, ±0.1pF, ±0.25pF	260	200	0.125±0.013	R
TVS021 CH0R3□K-W			CH	COH	0.3 p	±0.05pF, ±0.1pF, ±0.25pF	260	200	0.125±0.013	R
TVS021 CH0R4□K-W			CH	COH	0.4 p	±0.05pF, ±0.1pF, ±0.25pF	260	200	0.125±0.013	R
TVS021 CH0R5□K-W			CH	COH	0.5 p	±0.05pF, ±0.1pF, ±0.25pF	260	200	0.125±0.013	R
TVS021 CH0R6□K-W			CH	COH	0.6 p	±0.05pF, ±0.1pF, ±0.25pF	260	200	0.125±0.013	R
TVS021 CH0R7□K-W			CH	COH	0.7 p	±0.05pF, ±0.1pF, ±0.25pF	260	200	0.125±0.013	R
TVS021 CH0R75□K-W			CH	COH	0.75 p	±0.05pF, ±0.1pF, ±0.25pF	260	200	0.125±0.013	R
TVS021 CH0R8□K-W			CH	COH	0.8 p	±0.05pF, ±0.1pF, ±0.25pF	260	200	0.125±0.013	R
TVS021 CH0R9□K-W			CH	COH	0.9 p	±0.05pF, ±0.1pF, ±0.25pF	260	200	0.125±0.013	R
TVS021 CH010□K-W			CH	COH	1 p	±0.05pF, ±0.1pF, ±0.25pF	260	200	0.125±0.013	R
TVS021 CH1R1□K-W			CH	COH	1.1 p	±0.05pF, ±0.1pF, ±0.25pF	260	200	0.125±0.013	R
TVS021 CH1R2□K-W			CH	COH	1.2 p	±0.05pF, ±0.1pF, ±0.25pF	250	200	0.125±0.013	R
TVS021 CH1R3□K-W			CH	COH	1.3 p	±0.05pF, ±0.1pF, ±0.25pF	230	200	0.125±0.013	R
TVS021 CH1R4□K-W			CH	COH	1.4 p	±0.05pF, ±0.1pF, ±0.25pF	220	200	0.125±0.013	R
TVS021 CH1R5□K-W			CH	COH	1.5 p	±0.05pF, ±0.1pF, ±0.25pF	210	200	0.125±0.013	R
TVS021 CH1R6□K-W			CH	COH	1.6 p	±0.05pF, ±0.1pF, ±0.25pF	190	200	0.125±0.013	R
TVS021 CH1R7□K-W			CH	COH	1.7 p	±0.05pF, ±0.1pF, ±0.25pF	190	200	0.125±0.013	R
TVS021 CH1R8□K-W			CH	COH	1.8 p	±0.05pF, ±0.1pF, ±0.25pF	180	200	0.125±0.013	R
TVS021 CH1R9□K-W			CH	COH	1.9 p	±0.05pF, ±0.1pF, ±0.25pF	170	200	0.125±0.013	R
TVS021 CH020□K-W			CH	COH	2 p	±0.05pF, ±0.1pF, ±0.25pF	160	200	0.125±0.013	R
TVS021 CH2R1□K-W			CH	COH	2.1 p	±0.05pF, ±0.1pF, ±0.25pF	160	200	0.125±0.013	R
TVS021 CH2R2□K-W			CH	COH	2.2 p	±0.05pF, ±0.1pF, ±0.25pF	150	200	0.125±0.013	R
TVS021 CH2R3□K-W			CH	COH	2.3 p	±0.05pF, ±0.1pF, ±0.25pF	150	200	0.125±0.013	R
TVS021 CH2R4□K-W			CH	COH	2.4 p	±0.05pF, ±0.1pF, ±0.25pF	140	200	0.125±0.013	R
TVS021 CH2R5□K-W			CH	COH	2.5 p	±0.05pF, ±0.1pF, ±0.25pF	140	200	0.125±0.013	R
TVS021 CH2R6□K-W			CH	COH	2.6 p	±0.05pF, ±0.1pF, ±0.25pF	130	200	0.125±0.013	R
TVS021 CH2R7□K-W			CH	COH	2.7 p	±0.05pF, ±0.1pF, ±0.25pF	130	200	0.125±0.013	R
TVS021 CH2R8□K-W			CH	COH	2.8 p	±0.05pF, ±0.1pF, ±0.25pF	120	200	0.125±0.013	R
TVS021 CH2R9□K-W			CH	COH	2.9 p	±0.05pF, ±0.1pF, ±0.25pF	120	200	0.125±0.013	R
TVS021 CH030□K-W			CH	COH	3 p	±0.1pF, ±0.25pF, ±0.5pF	120	200	0.125±0.013	R
TVS021 CH3R1□K-W			CH	COH	3.1 p	±0.1pF, ±0.25pF, ±0.5pF	110	200	0.125±0.013	R
TVS021 CH3R2□K-W			CH	COH	3.2 p	±0.1pF, ±0.25pF, ±0.5pF	110	200	0.125±0.013	R
TVS021 CH3R3□K-W			CH	COH	3.3 p	±0.1pF, ±0.25pF, ±0.5pF	110	200	0.125±0.013	R
TVS021 CH3R4□K-W			CH	COH	3.4 p	±0.1pF, ±0.25pF, ±0.5pF	110	200	0.125±0.013	R
TVS021 CH3R5□K-W			CH	COH	3.5 p	±0.1pF, ±0.25pF, ±0.5pF	100	200	0.125±0.013	R
TVS021 CH3R6□K-W			CH	COH	3.6 p	±0.1pF, ±0.25pF, ±0.5pF	100	200	0.125±0.013	R
TVS021 CH3R7□K-W			CH	COH	3.7 p	±0.1pF, ±0.25pF, ±0.5pF	100	200	0.125±0.013	R
TVS021 CH3R8□K-W			CH	COH	3.8 p	±0.1pF, ±0.25pF, ±0.5pF	100	200	0.125±0.013	R
TVS021 CH3R9□K-W			CH	COH	3.9 p	±0.1pF, ±0.25pF, ±0.5pF	90	200	0.125±0.013	R
TVS021 CH040□K-W			CH	COH	4 p	±0.1pF, ±0.25pF, ±0.5pF	90	200	0.125±0.013	R
TVS021 CH4R1□K-W			CH	COH	4.1 p	±0.1pF, ±0.25pF, ±0.5pF	90	200	0.125±0.013	R
TVS021 CH4R2□K-W			CH	COH	4.2 p	±0.1pF, ±0.25pF, ±0.5pF	90	200	0.125±0.013	R
TVS021 CH4R3□K-W			CH	COH	4.3 p	±0.1pF, ±0.25pF, ±0.5pF	90	200	0.125±0.013	R
TVS021 CH4R4□K-W			CH	COH	4.4 p	±0.1pF, ±0.25pF, ±0.5pF	90	200	0.125±0.013	R
TVS021 CH4R5□K-W			CH	COH	4.5 p	±0.1pF, ±0.25pF, ±0.5pF	80	200	0.125±0.013	R
TVS021 CH4R6□K-W			CH	COH	4.6 p	±0.1pF, ±0.25pF, ±0.5pF	80	200	0.125±0.013	R
TVS021 CH4R7□K-W			CH	COH	4.7 p	±0.1pF, ±0.25pF, ±0.5pF	80	200	0.125±0.013	R
TVS021 CH4R8□K-W			CH	COH	4.8 p	±0.1pF, ±0.25pF, ±0.5pF	80	200	0.125±0.013	R
TVS021 CH4R9□K-W			CH	COH	4.9 p	±0.1pF, ±0.25pF, ±0.5pF	80	200	0.125±0.013	R
TVS021 CH050□K-W			CH	COH	5 p	±0.1pF, ±0.25pF, ±0.5pF	80	200	0.125±0.013	R
TVS021 CH5R1□K-W			CH	COH	5.1 p	±0.1pF, ±0.25pF, ±0.5pF	80	200	0.125±0.013	R
EVS021 CH5R2□K-W			CH	COH	5.2 p	±0.1pF, ±0.25pF, ±0.5pF	70	200	0.125±0.013	R
EVS021 CH5R3□K-W			CH	COH	5.3 p	±0.1pF, ±0.25pF, ±0.5pF	70	200	0.125±0.013	R
EVS021 CH5R4□K-W			CH	COH	5.4 p	±0.1pF, ±0.25pF, ±0.5pF	70	200	0.125±0.013	R
EVS021 CH5R5□K-W		CH	COH	5.5 p	±0.1pF, ±0.25pF, ±0.5pF	70	200	0.125±0.013	R	
EVS021 CH5R6□K-W		CH	COH	5.6 p	±0.1pF, ±0.25pF, ±0.5pF	70	200	0.125±0.013	R	
EVS021 CH5R7□K-W		CH	COH	5.7 p	±0.1pF, ±0.25pF, ±0.5pF	70	200	0.125±0.013	R	
EVS021 CH5R8□K-W		CH	COH	5.8 p	±0.1pF, ±0.25pF, ±0.5pF	70	200	0.125±0.013	R	
EVS021 CH5R9□K-W		CH	COH	5.9 p	±0.1pF, ±0.25pF, ±0.5pF	70	200	0.125±0.013	R	
EVS021 CH060□K-W		CH	COH	6 p	±0.1pF, ±0.25pF, ±0.5pF	70	200	0.125±0.013	R	
EVS021 CH6R1□K-W		CH	COH	6.1 p	±0.1pF, ±0.25pF, ±0.5pF	70	200	0.125±0.013	R	
EVS021 CH6R2□K-W		CH	COH	6.2 p	±0.1pF, ±0.25pF, ±0.5pF	60	200	0.125±0.013	R	
EVS021 CH6R3□K-W		CH	COH	6.3 p	±0.1pF, ±0.25pF, ±0.5pF	60	200	0.125±0.013	R	
EVS021 CH6R4□K-W		CH	COH	6.4 p	±0.1pF, ±0.25pF, ±0.5pF	60	200	0.125±0.013	R	
EVS021 CH6R5□K-W		CH	COH	6.5 p	±0.1pF, ±0.25pF, ±0.5pF	60	200	0.125±0.013	R	
EVS021 CH6R6□K-W		CH	COH	6.6 p	±0.1pF, ±0.25pF, ±0.5pF	60	200	0.125±0.013	R	
EVS021 CH6R7□K-W		CH	COH	6.7 p	±0.1pF, ±0.25pF, ±0.5pF	60	200	0.125±0.013	R	
EVS021 CH6R8□K-W		CH	COH	6.8 p	±0.1pF, ±0.25pF, ±0.5pF	60	200	0.125±0.013	R	
EVS021 CH6R9□K-W		CH	COH	6.9 p	±0.1pF, ±0.25pF, ±0.5pF	60	200	0.125±0.013	R	
EVS021 CH070□K-W		CH	COH	7 p	±0.1pF, ±0.25pF, ±0.5pF	60	200	0.125±0.013	R	
EVS021 CH7R1□K-W		CH	COH	7.1 p	±0.1pF, ±0.25pF, ±0.5pF	60	200	0.125±0.013	R	
EVS021 CH7R2□K-W		CH	COH	7.2 p	±0.1pF, ±0.25pF, ±0.5pF	60	200	0.125±0.013	R	
EVS021 CH7R3□K-W		CH	COH	7.3 p	±0.1pF, ±0.25pF, ±0.5pF	60	200	0.125±0.013	R	
EVS021 CH7R4□K-W		CH	COH	7.4 p	±0.1pF, ±0.25pF, ±0.5pF	60	200	0.125±0.013	R	
EVS021 CH7R5□K-W		CH	COH	7.5 p	±0.1pF, ±0.25pF, ±0.5pF	60	200	0.125±0.013	R	
EVS021 CH7R6□K-W		CH	COH	7.6 p	±0.1pF, ±0.25pF, ±0.5pF	60	200	0.125±0.013	R	
EVS021 CH7R7□K-W		CH	COH	7.7 p	±0.1pF, ±0.25pF, ±0.5pF	50	200	0.125±0.013	R	
EVS021 CH7R8□K-W		CH	COH	7.8 p	±0.1pF, ±0.25pF, ±0.5pF	50	200	0.125±0.013	R	
EVS021 CH7R9□K-W		CH	COH	7.9 p	±0.1pF, ±0.25pF, ±0.5pF	50	200	0.125±0.013	R	
EVS021 CH080□K-W		CH	COH	8 p	±0.1pF, ±0.25pF, ±0.5pF	50	200	0.125±0.013	R	
EVS021 CH8R1□K-W		CH	COH	8.1 p	±0.1pF, ±0.25pF, ±0.5pF	50	200	0.125±0.013	R	
EVS021 CH8R2□K-W		CH	COH	8.2 p	±0.1pF, ±0.25pF, ±0.5pF	50	200	0.125±0.013	R	
EVS021 CH8R3□K-W		CH	COH	8.3 p	±0.1pF, ±0.25pF, ±0.5pF	50	200	0.125±0.013	R	
EVS021 CH8R4□K-W		CH	COH	8.4 p	±0.1pF, ±0.25pF, ±0.5pF	50	200	0.125±0.013	R	
EVS021 CH8R5□K-W		CH	COH	8.5 p	±0.1pF, ±0.25pF, ±0.5pF	50	200	0.125±0.013	R	

▶ 由于篇幅有限, 本产品目录中只记载了有代表性的产品规格, 若考虑使用敝公司产品时, 请确认交货规格说明书中的详细规格。另外, 有关各产品的详细信息(特性图、可靠性信息、使用时的注意事项等), 请参阅敝公司网站 (<http://www.ty-top.com/>)。

■ 型号一览

型号1	型号2	额定电压 [V]	温度特性		静电容量 [F]	静电容量允许偏差	Q值 (at 1GHz) (min)	高温负载	厚度 <sup>3</sup> [mm]	焊接方式 R: 回流焊 W: 波峰焊
								额定电压 x %		
EVS021 CH8R6□K-W		16	CH	C0H	8.6 p	±0.1pF, ±0.25pF, ±0.5pF	50	200	0.125±0.013	R
EVS021 CH8R7□K-W			CH	C0H	8.7 p	±0.1pF, ±0.25pF, ±0.5pF	50	200	0.125±0.013	R
EVS021 CH8R8□K-W			CH	C0H	8.8 p	±0.1pF, ±0.25pF, ±0.5pF	50	200	0.125±0.013	R
EVS021 CH8R9□K-W			CH	C0H	8.9 p	±0.1pF, ±0.25pF, ±0.5pF	50	200	0.125±0.013	R
EVS021 CH090□K-W			CH	C0H	9 p	±0.1pF, ±0.25pF, ±0.5pF	50	200	0.125±0.013	R
EVS021 CH9R1□K-W			CH	C0H	9.1 p	±0.1pF, ±0.25pF, ±0.5pF	50	200	0.125±0.013	R
EVS021 CH9R2□K-W			CH	C0H	9.2 p	±0.1pF, ±0.25pF, ±0.5pF	50	200	0.125±0.013	R
EVS021 CH9R3□K-W			CH	C0H	9.3 p	±0.1pF, ±0.25pF, ±0.5pF	50	200	0.125±0.013	R
EVS021 CH9R4□K-W			CH	C0H	9.4 p	±0.1pF, ±0.25pF, ±0.5pF	50	200	0.125±0.013	R
EVS021 CH9R5□K-W			CH	C0H	9.5 p	±0.1pF, ±0.25pF, ±0.5pF	50	200	0.125±0.013	R
EVS021 CH9R6□K-W			CH	C0H	9.6 p	±0.1pF, ±0.25pF, ±0.5pF	50	200	0.125±0.013	R
EVS021 CH9R7□K-W			CH	C0H	9.7 p	±0.1pF, ±0.25pF, ±0.5pF	50	200	0.125±0.013	R
EVS021 CH9R8□K-W			CH	C0H	9.8 p	±0.1pF, ±0.25pF, ±0.5pF	40	200	0.125±0.013	R
EVS021 CH9R9□K-W			CH	C0H	9.9 p	±0.1pF, ±0.25pF, ±0.5pF	40	200	0.125±0.013	R
EVS021 CH100□K-W			CH	C0H	10 p	±2%, ±5%	50	200	0.125±0.013	R

● 042规格

【温度特性 CH: CH/C0H (-55 ~ +125°C)】 0.2mm厚度 (C)

型号1	型号2	额定电压 [V]	温度特性		静电容量 [F]	静电容量允许偏差	Q值 (at 1GHz) (min)	高温负载	厚度 <sup>3</sup> [mm]	焊接方式 R: 回流焊 W: 波峰焊
								额定电压 x %		
TVS042 CH0R2□C-W		25	CH	C0H	0.2 p	±0.05pF, ±0.1pF, ±0.25pF	300	200	0.2±0.02	R
TVS042 CH0R3□C-W			CH	C0H	0.3 p	±0.05pF, ±0.1pF, ±0.25pF	300	200	0.2±0.02	R
TVS042 CH0R4□C-W			CH	C0H	0.4 p	±0.05pF, ±0.1pF, ±0.25pF	300	200	0.2±0.02	R
TVS042 CH0R5□C-W			CH	C0H	0.5 p	±0.05pF, ±0.1pF, ±0.25pF	300	200	0.2±0.02	R
TVS042 CH0R6□C-W			CH	C0H	0.6 p	±0.05pF, ±0.1pF, ±0.25pF	300	200	0.2±0.02	R
TVS042 CH0R7□C-W			CH	C0H	0.7 p	±0.05pF, ±0.1pF, ±0.25pF	300	200	0.2±0.02	R
TVS042 CHR75□C-W			CH	C0H	0.75 p	±0.05pF, ±0.1pF, ±0.25pF	300	200	0.2±0.02	R
TVS042 CH0R8□C-W			CH	C0H	0.8 p	±0.05pF, ±0.1pF, ±0.25pF	300	200	0.2±0.02	R
TVS042 CH0R9□C-W			CH	C0H	0.9 p	±0.05pF, ±0.1pF, ±0.25pF	300	200	0.2±0.02	R
TVS042 CH010□C-W			CH	C0H	1 p	±0.05pF, ±0.1pF, ±0.25pF	300	200	0.2±0.02	R
TVS042 CH1R1□C-W			CH	C0H	1.1 p	±0.05pF, ±0.1pF, ±0.25pF	280	200	0.2±0.02	R
TVS042 CH1R2□C-W			CH	C0H	1.2 p	±0.05pF, ±0.1pF, ±0.25pF	270	200	0.2±0.02	R
TVS042 CH1R3□C-W			CH	C0H	1.3 p	±0.05pF, ±0.1pF, ±0.25pF	260	200	0.2±0.02	R
TVS042 CH1R4□C-W			CH	C0H	1.4 p	±0.05pF, ±0.1pF, ±0.25pF	250	200	0.2±0.02	R
TVS042 CH1R5□C-W			CH	C0H	1.5 p	±0.05pF, ±0.1pF, ±0.25pF	240	200	0.2±0.02	R
TVS042 CH1R6□C-W			CH	C0H	1.6 p	±0.05pF, ±0.1pF, ±0.25pF	230	200	0.2±0.02	R
TVS042 CH1R7□C-W			CH	C0H	1.7 p	±0.05pF, ±0.1pF, ±0.25pF	220	200	0.2±0.02	R
TVS042 CH1R8□C-W			CH	C0H	1.8 p	±0.05pF, ±0.1pF, ±0.25pF	210	200	0.2±0.02	R
TVS042 CH1R9□C-W			CH	C0H	1.9 p	±0.05pF, ±0.1pF, ±0.25pF	200	200	0.2±0.02	R
TVS042 CH020□C-W			CH	C0H	2 p	±0.05pF, ±0.1pF, ±0.25pF	190	200	0.2±0.02	R
TVS042 CH2R1□C-W			CH	C0H	2.1 p	±0.05pF, ±0.1pF, ±0.25pF	185	200	0.2±0.02	R
TVS042 CH2R2□C-W			CH	C0H	2.2 p	±0.05pF, ±0.1pF, ±0.25pF	180	200	0.2±0.02	R
TVS042 CH2R3□C-W			CH	C0H	2.3 p	±0.05pF, ±0.1pF, ±0.25pF	175	200	0.2±0.02	R
TVS042 CH2R4□C-W			CH	C0H	2.4 p	±0.05pF, ±0.1pF, ±0.25pF	170	200	0.2±0.02	R
TVS042 CH2R5□C-W			CH	C0H	2.5 p	±0.05pF, ±0.1pF, ±0.25pF	160	200	0.2±0.02	R
TVS042 CH2R6□C-W			CH	C0H	2.6 p	±0.05pF, ±0.1pF, ±0.25pF	155	200	0.2±0.02	R
TVS042 CH2R7□C-W			CH	C0H	2.7 p	±0.05pF, ±0.1pF, ±0.25pF	150	200	0.2±0.02	R
TVS042 CH2R8□C-W			CH	C0H	2.8 p	±0.05pF, ±0.1pF, ±0.25pF	140	200	0.2±0.02	R
TVS042 CH2R9□C-W			CH	C0H	2.9 p	±0.05pF, ±0.1pF, ±0.25pF	135	200	0.2±0.02	R
TVS042 CH030□C-W			CH	C0H	3 p	±0.05pF, ±0.1pF, ±0.25pF	130	200	0.2±0.02	R
TVS042 CH3R1□C-W			CH	C0H	3.1 p	±0.1pF, ±0.25pF	125	200	0.2±0.02	R
TVS042 CH3R2□C-W			CH	C0H	3.2 p	±0.1pF, ±0.25pF	125	200	0.2±0.02	R
TVS042 CH3R3□C-W			CH	C0H	3.3 p	±0.1pF, ±0.25pF	120	200	0.2±0.02	R
TVS042 CH3R4□C-W			CH	C0H	3.4 p	±0.1pF, ±0.25pF	120	200	0.2±0.02	R
TVS042 CH3R5□C-W			CH	C0H	3.5 p	±0.1pF, ±0.25pF	110	200	0.2±0.02	R
TVS042 CH3R6□C-W			CH	C0H	3.6 p	±0.1pF, ±0.25pF	110	200	0.2±0.02	R
TVS042 CH3R7□C-W			CH	C0H	3.7 p	±0.1pF, ±0.25pF	110	200	0.2±0.02	R
TVS042 CH3R8□C-W			CH	C0H	3.8 p	±0.1pF, ±0.25pF	100	200	0.2±0.02	R
TVS042 CH3R9□C-W			CH	C0H	3.9 p	±0.1pF, ±0.25pF	100	200	0.2±0.02	R
TVS042 CH040□C-W			CH	C0H	4 p	±0.1pF, ±0.25pF	90	200	0.2±0.02	R
TVS042 CH4R1□C-W			CH	C0H	4.1 p	±0.1pF, ±0.25pF	90	200	0.2±0.02	R
TVS042 CH4R2□C-W			CH	C0H	4.2 p	±0.1pF, ±0.25pF	85	200	0.2±0.02	R
TVS042 CH4R3□C-W		CH	C0H	4.3 p	±0.1pF, ±0.25pF	85	200	0.2±0.02	R	
TVS042 CH4R4□C-W		CH	C0H	4.4 p	±0.1pF, ±0.25pF	85	200	0.2±0.02	R	
TVS042 CH4R5□C-W		CH	C0H	4.5 p	±0.1pF, ±0.25pF	85	200	0.2±0.02	R	
TVS042 CH4R6□C-W		CH	C0H	4.6 p	±0.1pF, ±0.25pF	85	200	0.2±0.02	R	
TVS042 CH4R7□C-W		CH	C0H	4.7 p	±0.1pF, ±0.25pF	85	200	0.2±0.02	R	
TVS042 CH4R8□C-W		CH	C0H	4.8 p	±0.1pF, ±0.25pF	80	200	0.2±0.02	R	
TVS042 CH4R9□C-W		CH	C0H	4.9 p	±0.1pF, ±0.25pF	80	200	0.2±0.02	R	
TVS042 CH050□C-W		CH	C0H	5 p	±0.1pF, ±0.25pF	80	200	0.2±0.02	R	
TVS042 CH5R1□C-W		CH	C0H	5.1 p	±0.1pF, ±0.25pF, ±0.5pF	75	200	0.2±0.02	R	
TVS042 CH5R2□C-W		CH	C0H	5.2 p	±0.1pF, ±0.25pF, ±0.5pF	75	200	0.2±0.02	R	
TVS042 CH5R3□C-W		CH	C0H	5.3 p	±0.1pF, ±0.25pF, ±0.5pF	75	200	0.2±0.02	R	
TVS042 CH5R4□C-W		CH	C0H	5.4 p	±0.1pF, ±0.25pF, ±0.5pF	70	200	0.2±0.02	R	
TVS042 CH5R5□C-W		CH	C0H	5.5 p	±0.1pF, ±0.25pF, ±0.5pF	70	200	0.2±0.02	R	
TVS042 CH5R6□C-W		CH	C0H	5.6 p	±0.1pF, ±0.25pF, ±0.5pF	70	200	0.2±0.02	R	
TVS042 CH5R7□C-W		CH	C0H	5.7 p	±0.1pF, ±0.25pF, ±0.5pF	70	200	0.2±0.02	R	
TVS042 CH5R8□C-W		CH	C0H	5.8 p	±0.1pF, ±0.25pF, ±0.5pF	70	200	0.2±0.02	R	
TVS042 CH5R9□C-W		CH	C0H	5.9 p	±0.1pF, ±0.25pF, ±0.5pF	65	200	0.2±0.02	R	
TVS042 CH060□C-W		CH	C0H	6 p	±0.1pF, ±0.25pF, ±0.5pF	65	200	0.2±0.02	R	
TVS042 CH6R1□C-W		CH	C0H	6.1 p	±0.1pF, ±0.25pF, ±0.5pF	65	200	0.2±0.02	R	
TVS042 CH6R2□C-W		CH	C0H	6.2 p	±0.1pF, ±0.25pF, ±0.5pF	65	200	0.2±0.02	R	
TVS042 CH6R3□C-W		CH	C0H	6.3 p	±0.1pF, ±0.25pF, ±0.5pF	65	200	0.2±0.02	R	
TVS042 CH6R4□C-W		CH	C0H	6.4 p	±0.1pF, ±0.25pF, ±0.5pF	65	200	0.2±0.02	R	
TVS042 CH6R5□C-W		CH	C0H	6.5 p	±0.1pF, ±0.25pF, ±0.5pF	65	200	0.2±0.02	R	
TVS042 CH6R6□C-W		CH	C0H	6.6 p	±0.1pF, ±0.25pF, ±0.5pF	60	200	0.2±0.02	R	
TVS042 CH6R7□C-W		CH	C0H	6.7 p	±0.1pF, ±0.25pF, ±0.5pF	60	200	0.2±0.02	R	
TVS042 CH6R8□C-W		CH	C0H	6.8 p	±0.1pF, ±0.25pF, ±0.5pF	60	200	0.2±0.02	R	

▶ 由于篇幅有限, 本产品目录中只记载了有代表性的产品规格, 若考虑使用敝公司产品时, 请确认交货规格说明书中的详细规格。另外, 有关各产品的详细信息(特性图、可靠性信息、使用时的注意事项等), 请参阅敝公司网站(<http://www.ty-top.com/>)。

型号1	型号2	额定电压 [V]	温度特性		静电容量 [F]	静电容量允许偏差	Q值 (at 1GHz) (min)	高温负载	厚度 <sup>-3</sup> [mm]	焊接方式 R: 回流焊 W: 波峰焊
								额定电压 x %		
TVS042 CH6R9□C-W		25	CH	C0H	6.9 p	±0.1pF, ±0.25pF, ±0.5pF	60	200	0.2±0.02	R
TVS042 CH070□C-W			CH	C0H	7 p	±0.1pF, ±0.25pF, ±0.5pF	60	200	0.2±0.02	R
TVS042 CH7R1□C-W			CH	C0H	7.1 p	±0.1pF, ±0.25pF, ±0.5pF	60	200	0.2±0.02	R
TVS042 CH7R2□C-W			CH	C0H	7.2 p	±0.1pF, ±0.25pF, ±0.5pF	60	200	0.2±0.02	R
TVS042 CH7R3□C-W			CH	C0H	7.3 p	±0.1pF, ±0.25pF, ±0.5pF	55	200	0.2±0.02	R
TVS042 CH7R4□C-W			CH	C0H	7.4 p	±0.1pF, ±0.25pF, ±0.5pF	55	200	0.2±0.02	R
TVS042 CH7R5□C-W			CH	C0H	7.5 p	±0.1pF, ±0.25pF, ±0.5pF	55	200	0.2±0.02	R
TVS042 CH7R6□C-W			CH	C0H	7.6 p	±0.1pF, ±0.25pF, ±0.5pF	55	200	0.2±0.02	R
TVS042 CH7R7□C-W			CH	C0H	7.7 p	±0.1pF, ±0.25pF, ±0.5pF	55	200	0.2±0.02	R
TVS042 CH7R8□C-W			CH	C0H	7.8 p	±0.1pF, ±0.25pF, ±0.5pF	55	200	0.2±0.02	R
TVS042 CH7R9□C-W			CH	C0H	7.9 p	±0.1pF, ±0.25pF, ±0.5pF	55	200	0.2±0.02	R
TVS042 CH080□C-W			CH	C0H	8 p	±0.1pF, ±0.25pF, ±0.5pF	55	200	0.2±0.02	R
TVS042 CH8R1□C-W			CH	C0H	8.1 p	±0.1pF, ±0.25pF, ±0.5pF	55	200	0.2±0.02	R
TVS042 CH8R2□C-W			CH	C0H	8.2 p	±0.1pF, ±0.25pF, ±0.5pF	50	200	0.2±0.02	R
TVS042 CH8R3□C-W			CH	C0H	8.3 p	±0.1pF, ±0.25pF, ±0.5pF	50	200	0.2±0.02	R
TVS042 CH8R4□C-W			CH	C0H	8.4 p	±0.1pF, ±0.25pF, ±0.5pF	50	200	0.2±0.02	R
TVS042 CH8R5□C-W			CH	C0H	8.5 p	±0.1pF, ±0.25pF, ±0.5pF	50	200	0.2±0.02	R
TVS042 CH8R6□C-W			CH	C0H	8.6 p	±0.1pF, ±0.25pF, ±0.5pF	50	200	0.2±0.02	R
TVS042 CH8R7□C-W			CH	C0H	8.7 p	±0.1pF, ±0.25pF, ±0.5pF	50	200	0.2±0.02	R
TVS042 CH8R8□C-W			CH	C0H	8.8 p	±0.1pF, ±0.25pF, ±0.5pF	50	200	0.2±0.02	R
TVS042 CH8R9□C-W			CH	C0H	8.9 p	±0.1pF, ±0.25pF, ±0.5pF	50	200	0.2±0.02	R
TVS042 CH090□C-W			CH	C0H	9 p	±0.1pF, ±0.25pF, ±0.5pF	50	200	0.2±0.02	R
TVS042 CH9R1□C-W			CH	C0H	9.1 p	±0.1pF, ±0.25pF, ±0.5pF	45	200	0.2±0.02	R
TVS042 CH9R2□C-W			CH	C0H	9.2 p	±0.1pF, ±0.25pF, ±0.5pF	45	200	0.2±0.02	R
TVS042 CH9R3□C-W			CH	C0H	9.3 p	±0.1pF, ±0.25pF, ±0.5pF	45	200	0.2±0.02	R
TVS042 CH9R4□C-W			CH	C0H	9.4 p	±0.1pF, ±0.25pF, ±0.5pF	45	200	0.2±0.02	R
TVS042 CH9R5□C-W			CH	C0H	9.5 p	±0.1pF, ±0.25pF, ±0.5pF	45	200	0.2±0.02	R
TVS042 CH9R6□C-W			CH	C0H	9.6 p	±0.1pF, ±0.25pF, ±0.5pF	45	200	0.2±0.02	R
TVS042 CH9R7□C-W			CH	C0H	9.7 p	±0.1pF, ±0.25pF, ±0.5pF	45	200	0.2±0.02	R
TVS042 CH9R8□C-W			CH	C0H	9.8 p	±0.1pF, ±0.25pF, ±0.5pF	45	200	0.2±0.02	R
TVS042 CH9R9□C-W			CH	C0H	9.9 p	±0.1pF, ±0.25pF, ±0.5pF	45	200	0.2±0.02	R
TVS042 CH100□C-W			CH	C0H	10 p	±2%, ±5%	45	200	0.2±0.02	R
TVS042 CH110JC-W			CH	C0H	11 p	±5%	40	200	0.2±0.02	R
TVS042 CH120JC-W			CH	C0H	12 p	±5%	40	200	0.2±0.02	R
TVS042 CH130JC-W			CH	C0H	13 p	±5%	40	200	0.2±0.02	R
TVS042 CH150JC-W			CH	C0H	15 p	±5%	40	200	0.2±0.02	R
TVS042 CH160JC-W			CH	C0H	16 p	±5%	40	200	0.2±0.02	R
TVS042 CH180JC-W			CH	C0H	18 p	±5%	40	200	0.2±0.02	R
TVS042 CH220JC-W			CH	C0H	22 p	±5%	30	200	0.2±0.02	R

## 超低失真多层陶瓷电容器

### ● 105规格

【温度特性 SD: Standard (-55 ~ +125°C)】 0.5mm厚度 (V)

型号1	型号2	额定电压 [V]	温度特性	静电容量 [F]	静电容量允许偏差 [%]	tanδ [%]	高温负载	厚度 <sup>3</sup> [mm]	焊接方式 R: 回流焊 W: 波峰焊
							额定电压 x %		
UMK105 SD391KV-F		50	Standard Type	390 p	±10	0.1	200	0.5±0.05	R
UMK105 SD471KV-F				470 p	±10	0.1	200	0.5±0.05	R
UMK105 SD561KV-F		560 p		±10	0.1	200	0.5±0.05	R	
TMK105 SD681KV-F		680 p		±10	0.1	200	0.5±0.05	R	
TMK105 SD821KV-F		25		820 p	±10	0.1	200	0.5±0.05	R
TMK105 SD102KV-F				1000 p	±10	0.1	200	0.5±0.05	R
TMK105 SD122KV-F				1200 p	±10	0.1	200	0.5±0.05	R
EMK105 SD152KV-F				1500 p	±10	0.1	200	0.5±0.05	R
EMK105 SD182KV-F		16		1800 p	±10	0.1	200	0.5±0.05	R
EMK105 SD222KV-F				2200 p	±10	0.1	200	0.5±0.05	R
EMK105 SD272KV-F				2700 p	±10	0.1	200	0.5±0.05	R
LMK105 SD332KV-F				3300 p	±10	0.1	200	0.5±0.05	R
LMK105 SD392KV-F		10	3900 p	±10	0.1	200	0.5±0.05	R	
LMK105 SD472KV-F			4700 p	±10	0.1	200	0.5±0.05	R	

【温度特性 SD: Standard (-55 ~ +125°C)】 0.3mm厚度 (P)

型号1	型号2	额定电压 [V]	温度特性	静电容量 [F]	静电容量允许偏差 [%]	tanδ [%]	高温负载	厚度 <sup>3</sup> [mm]	焊接方式 R: 回流焊 W: 波峰焊
							额定电压 x %		
LMK105 SD152KP-F		10	Standard Type	1500 p	±10	0.1	200	0.3±0.03	R
JMK105 SD272KP-F		6.3		2700 p	±10	0.1	200	0.3±0.03	R

### ● 107规格

【温度特性 SD: Standard (-55 ~ +125°C)】 0.8mm厚度 (A)

型号1	型号2	额定电压 [V]	温度特性	静电容量 [F]	静电容量允许偏差 [%]	tanδ [%]	高温负载	厚度 <sup>3</sup> [mm]	焊接方式 R: 回流焊 W: 波峰焊
							额定电压 x %		
UMK107 SD102KA-T		50	Standard Type	1000 p	±10	0.1	200	0.8±0.10	R
UMK107 SD122KA-T				1200 p	±10	0.1	200	0.8±0.10	R
UMK107 SD152KA-T				1500 p	±10	0.1	200	0.8±0.10	R
UMK107 SD182KA-T				1800 p	±10	0.1	200	0.8±0.10	R
UMK107 SD222KA-T				2200 p	±10	0.1	200	0.8±0.10	R
UMK107 SD272KA-T				2700 p	±10	0.1	200	0.8±0.10	R
UMK107 SD332KA-T		25		3300 p	±10	0.1	200	0.8±0.10	R
TMK107 SD392KA-T				3900 p	±10	0.1	200	0.8±0.10	R
TMK107 SD472KA-T		16		4700 p	±10	0.1	200	0.8±0.10	R
EMK107 SD562KA-T				5600 p	±10	0.1	200	0.8±0.10	R
EMK107 SD682KA-T				6800 p	±10	0.1	200	0.8±0.10	R
EMK107 SD822KA-T				8200 p	±10	0.1	200	0.8±0.10	R
EMK107 SD103KA-T		10	0.01 μ	±10	0.1	200	0.8±0.10	R	
LMK107 SD123KA-T			0.012 μ	±10	0.1	200	0.8±0.10	R	
LMK107 SD153KA-T			0.015 μ	±10	0.1	200	0.8±0.10	R	
LMK107 SD183KA-T			0.018 μ	±10	0.1	200	0.8±0.10	R	
LMK107 SD223KA-T			0.022 μ	±10	0.1	200	0.8±0.10	R	

### ● 212规格

【温度特性 SD: Standard (-55 ~ +125°C)】 1.25mm厚度 (G)

型号1	型号2	额定电压 [V]	温度特性	静电容量 [F]	静电容量允许偏差 [%]	tanδ [%]	高温负载	厚度 <sup>3</sup> [mm]	焊接方式 R: 回流焊 W: 波峰焊
							额定电压 x %		
GMK212 SD183KG-T		35	Standard Type	0.018 μ	±10	0.1	200	1.25±0.10	R
GMK212 SD223KG-T				0.022 μ	±10	0.1	200	1.25±0.10	R
GMK212 SD273KG-T				0.027 μ	±10	0.1	200	1.25±0.10	R
LMK212 SD683KG-T		10		0.068 μ	±10	0.1	200	1.25±0.10	R
LMK212 SD823KG-T				0.082 μ	±10	0.1	200	1.25±0.10	R
LMK212 SD104KG-T				0.1 μ	±10	0.1	200	1.25±0.10	R

【温度特性 SD: Standard (-55 ~ +125°C)】 0.85mm厚度 (D)

型号1	型号2	额定电压 [V]	温度特性	静电容量 [F]	静电容量允许偏差 [%]	tanδ [%]	高温负载	厚度 <sup>3</sup> [mm]	焊接方式 R: 回流焊 W: 波峰焊
							额定电压 x %		
UMK212 SD392KD-T		50	Standard Type	3900 p	±10	0.1	200	0.85±0.10	R
UMK212 SD472KD-T				4700 p	±10	0.1	200	0.85±0.10	R
UMK212 SD562KD-T				5600 p	±10	0.1	200	0.85±0.10	R
UMK212 SD682KD-T				6800 p	±10	0.1	200	0.85±0.10	R
UMK212 SD822KD-T				8200 p	±10	0.1	200	0.85±0.10	R
UMK212 SD103KD-T				0.01 μ	±10	0.1	200	0.85±0.10	R
GMK212 SD123KD-T		35		0.012 μ	±10	0.1	200	0.85±0.10	R
GMK212 SD153KD-T				0.015 μ	±10	0.1	200	0.85±0.10	R
EMK212 SD333KD-T				0.033 μ	±10	0.1	200	0.85±0.10	R
LMK212 SD473KD-T		10		0.047 μ	±10	0.1	200	0.85±0.10	R

▶ 由于篇幅有限，本产品目录中只记载了有代表性的产品规格，若考虑使用敝公司产品时，请确认交货规格说明书中的详细规格。另外，有关各产品的详细信息(特性图、可靠性信息、使用时的注意事项等)，请参阅敝公司网站(<http://www.ty-top.com/>)。

## ● 316规格

【温度特性 SD: Standard (-55 ~ +125°C)】 1.6mm厚度 (L)

型号1	型号2	额定电压 [V]	温度特性	静电容量 [F]	静电容量允许偏差 [%]	tanδ [%]	高温负载	厚度 <sup>-3</sup> [mm]	焊接方式 R: 回流焊 W: 波峰焊
							额定电压 x %		
TMK316 SD823KL-T		25	Standard Type	0.082 μ	±10	0.1	200	1.6±0.20	R
TMK316 SD104KL-T				0.1 μ	±10	0.1	200	1.6±0.20	R

【温度特性 SD: Standard (-55 ~ +125°C)】 1.15mm厚度 (F)

型号1	型号2	额定电压 [V]	温度特性	静电容量 [F]	静电容量允许偏差 [%]	tanδ [%]	高温负载	厚度 <sup>-3</sup> [mm]	焊接方式 R: 回流焊 W: 波峰焊
							额定电压 x %		
GMK316 SD333KF-T		35	Standard Type	0.033 μ	±10	0.1	200	1.15±0.10	R
GMK316 SD393KF-T				0.039 μ	±10	0.1	200	1.15±0.10	R
TMK316 SD473KF-T		25	Standard Type	0.047 μ	±10	0.1	200	1.15±0.10	R
TMK316 SD563KF-T				0.056 μ	±10	0.1	200	1.15±0.10	R
TMK316 SD683KF-T				0.068 μ	±10	0.1	200	1.15±0.10	R

## 低失真大容量多层陶瓷电容器(CF\_LD)

## ●107规格

【温度特性 LD: X5R (-55 ~ +85°C)】 0.8mm厚度 (A)

型号1	型号2	额定电压 [V]	温度特性	静电容量 [F]	静电容量允许偏差 [%]	tanδ [%]	高温负载	厚度 <sup>3</sup> [mm]	焊接方式 R: 回流焊 W: 波峰焊
							额定电压 x %		
UMK107BLD224□A-T		50	X5R	0.22 μ	±10, ±20	10	150	0.8+0.20/-0	R
TMK107BLD474□A-T		25	X5R	0.47 μ	±10, ±20	10	150	0.8+0.20/-0	R
TMK107BLD105□A-T			X5R	1 μ	±10, ±20	10	150	0.8+0.20/-0	R

## ●212规格

【温度特性 LD: X5R (-55 ~ +85°C)】 1.25mm厚度 (G)

型号1	型号2	额定电压 [V]	温度特性	静电容量 [F]	静电容量允许偏差 [%]	tanδ [%]	高温负载	厚度 <sup>3</sup> [mm]	焊接方式 R: 回流焊 W: 波峰焊
							额定电压 x %		
GMK212 LD105□G-T		35	X5R	1 μ	±10, ±20	10	150	1.25±0.10	R
GMK212BLD225□G-T			X5R	2.2 μ	±10, ±20	10	150	1.25+0.20/-0	R

## ●316规格

【温度特性 LD: X5R (-55 ~ +85°C)】 1.6mm厚度 (L)

型号1	型号2	额定电压 [V]	温度特性	静电容量 [F]	静电容量允许偏差 [%]	tanδ [%]	高温负载	厚度 <sup>3</sup> [mm]	焊接方式 R: 回流焊 W: 波峰焊
							额定电压 x %		
UMK316 LD105□L-T		50	X5R	1 μ	±10, ±20	10	150	1.6±0.20	R
GMK316BLD475□L-T		35	X5R	4.7 μ	±10, ±20	10	150	1.6±0.30	R
TMK316BLD106□L-T		25	X5R	10 μ	±10, ±20	10	150	1.6±0.30	R

## ●325规格

【温度特性 LD: X5R (-55 ~ +85°C)】 1.9mm厚度 (N)

型号1	型号2	额定电压 [V]	温度特性	静电容量 [F]	静电容量允许偏差 [%]	tanδ [%]	高温负载	厚度 <sup>3</sup> [mm]	焊接方式 R: 回流焊 W: 波峰焊
							额定电压 x %		
UMK325 LD105□N-T		50	X5R	1 μ	±10, ±20	10	200	1.9±0.20	R

【温度特性 LD: X5R (-55 ~ +85°C)】 2.5mm厚度 (M)

型号1	型号2	额定电压 [V]	温度特性	静电容量 [F]	静电容量允许偏差 [%]	tanδ [%]	高温负载	厚度 <sup>3</sup> [mm]	焊接方式 R: 回流焊 W: 波峰焊
							额定电压 x %		
UMK325 LD475□M-P		50	X5R	4.7 μ	±10, ±20	10	200	2.5±0.20	R



■ 型号一览

## 中高耐压多层陶瓷电容器

## ● 105规格

【温度特性 B7 : X7R (-55 ~ +125°C)】 0.5mm厚度 (V)

型号1	型号2	额定电压 [V]	温度特性		静电容量 [F]	静电容量允许偏差 [%]	tanδ [%]	高温负载	厚度 <sup>-3</sup> [mm]	焊接方式 R: 回流焊 W: 波峰焊	
								额定电压 x %			
HMK105 B7221□V-F		100		X7R	220 p	±10, ±20	2.5	200	0.5±0.05	R	
HMK105 B7331□V-F				X7R	330 p	±10, ±20	2.5	200	0.5±0.05	R	
HMK105 B7471□V-F					X7R	470 p	±10, ±20	2.5	200	0.5±0.05	R
HMK105 B7681□V-F					X7R	680 p	±10, ±20	2.5	200	0.5±0.05	R
HMK105 B7102□V-F					X7R	1000 p	±10, ±20	2.5	200	0.5±0.05	R
HMK105 B7152□V-F					X7R	1500 p	±10, ±20	2.5	200	0.5±0.05	R
HMK105 B7222□V-F					X7R	2200 p	±10, ±20	2.5	200	0.5±0.05	R
HMK105 B7332□V-F					X7R	3300 p	±10, ±20	2.5	200	0.5±0.05	R
HMK105 B7472□V-F					X7R	4700 p	±10, ±20	2.5	200	0.5±0.05	R
HMK105 B7682□V-F					X7R	6800 p	±10, ±20	2.5	200	0.5±0.05	R

【温度特性 CH : CH/COH (-55 ~ +125°C)】 0.5mm厚度 (V)

型号1	型号2	额定电压 [V]	温度特性		静电容量 [F]	静电容量允许偏差	Q值 (at 1MHz) (min)	高温负载	厚度 <sup>-3</sup> [mm]	焊接方式 R: 回流焊 W: 波峰焊
								额定电压 x %		
HMK105 CH080DV-F		100	CH	C0H	8 p	±0.5pF	560	200	0.5±0.05	R
HMK105 CH090DV-F			CH	C0H	9 p	±0.5pF	580	200	0.5±0.05	R
HMK105 CH100DV-F			CH	C0H	10 p	±0.5pF	600	200	0.5±0.05	R
HMK105 CH120JV-F			CH	C0H	12 p	±5%	640	200	0.5±0.05	R
HMK105 CH150JV-F			CH	C0H	15 p	±5%	700	200	0.5±0.05	R
HMK105 CH180JV-F			CH	C0H	18 p	±5%	760	200	0.5±0.05	R
HMK105 CH220JV-F			CH	C0H	22 p	±5%	840	200	0.5±0.05	R
HMK105 CH240JV-F			CH	C0H	24 p	±5%	880	200	0.5±0.05	R
HMK105 CH270JV-F			CH	C0H	27 p	±5%	940	200	0.5±0.05	R
HMK105 CH330JV-F			CH	C0H	33 p	±5%	1000	200	0.5±0.05	R
HMK105 CH390JV-F			CH	C0H	39 p	±5%	1000	200	0.5±0.05	R
HMK105 CH470JV-F			CH	C0H	47 p	±5%	1000	200	0.5±0.05	R
HMK105 CH560JV-F			CH	C0H	56 p	±5%	1000	200	0.5±0.05	R
HMK105 CH680JV-F			CH	C0H	68 p	±5%	1000	200	0.5±0.05	R
HMK105 CH820JV-F			CH	C0H	82 p	±5%	1000	200	0.5±0.05	R
HMK105 CH101JV-F			CH	C0H	100 p	±5%	1000	200	0.5±0.05	R

## ● 107规格

【温度特性 BJ : B (-25 ~ +85°C) / X5R (-55 ~ +85°C)】 0.8mm厚度 (A)

型号1	型号2	额定电压 [V]	温度特性		静电容量 [F]	静电容量允许偏差 [%]	tanδ [%]	高温负载	厚度 <sup>-3</sup> [mm]	焊接方式 R: 回流焊 W: 波峰焊
								额定电压 x %		
HMK107 BJ102□A-T		100	B	X5R <sup>+</sup>	1000 p	±10, ±20	3.5	200	0.8±0.10	R
HMK107 BJ152□A-T			B	X5R <sup>+</sup>	1500 p	±10, ±20	3.5	200	0.8±0.10	R
HMK107 BJ222□A-T			B	X5R <sup>+</sup>	2200 p	±10, ±20	3.5	200	0.8±0.10	R
HMK107 BJ332□A-T			B	X5R <sup>+</sup>	3300 p	±10, ±20	3.5	200	0.8±0.10	R
HMK107 BJ472□A-T			B	X5R <sup>+</sup>	4700 p	±10, ±20	3.5	200	0.8±0.10	R
HMK107 BJ682□A-T			B	X5R <sup>+</sup>	6800 p	±10, ±20	3.5	200	0.8±0.10	R
HMK107 BJ103□A-T			B	X5R <sup>+</sup>	0.01 μ	±10, ±20	3.5	200	0.8±0.10	R
HMK107 BJ153□A-T			B	X5R <sup>+</sup>	0.015 μ	±10, ±20	3.5	200	0.8±0.10	R
HMK107 BJ223□A-T			B	X5R <sup>+</sup>	0.022 μ	±10, ±20	3.5	200	0.8±0.10	R
HMK107 BJ333□A-T			B	X5R <sup>+</sup>	0.033 μ	±10, ±20	3.5	200	0.8±0.10	R
HMK107 BJ473□A-T			B	X5R <sup>+</sup>	0.047 μ	±10, ±20	3.5	200	0.8±0.10	R
HMK107 BJ104□A-T			B	X5R <sup>+</sup>	0.1 μ	±10, ±20	3.5	200	0.8±0.10	R
HMK107 BJ224□A-TE			B	X5R <sup>+</sup>	0.22 μ	±10, ±20	3.5	150	0.8±0.10	R

【温度特性 C7 : X7S (-55 ~ +125°C)】 0.8mm厚度 (A)

型号1	型号2	额定电压 [V]	温度特性		静电容量 [F]	静电容量允许偏差 [%]	tanδ [%]	高温负载	厚度 <sup>-3</sup> [mm]	焊接方式 R: 回流焊 W: 波峰焊
								额定电压 x %		
HMK107 C7224□A-TE		100		X7S	0.22 μ	±10, ±20	3.5	150	0.8±0.10	R

【温度特性 B7 : X7R (-55 ~ +125°C)】 0.8mm厚度 (A)

型号1	型号2	额定电压 [V]	温度特性		静电容量 [F]	静电容量允许偏差 [%]	tanδ [%]	高温负载	厚度 <sup>-3</sup> [mm]	焊接方式 R: 回流焊 W: 波峰焊	
								额定电压 x %			
HMK107 B7102□A-T		100		X7R	1000 p	±10, ±20	3.5	200	0.8±0.10	R	
HMK107 B7152□A-T					X7R	1500 p	±10, ±20	3.5	200	0.8±0.10	R
HMK107 B7222□A-T					X7R	2200 p	±10, ±20	3.5	200	0.8±0.10	R
HMK107 B7332□A-T					X7R	3300 p	±10, ±20	3.5	200	0.8±0.10	R
HMK107 B7472□A-T					X7R	4700 p	±10, ±20	3.5	200	0.8±0.10	R
HMK107 B7682□A-T					X7R	6800 p	±10, ±20	3.5	200	0.8±0.10	R
HMK107 B7103□A-T					X7R	0.01 μ	±10, ±20	3.5	200	0.8±0.10	R
HMK107 B7153□A-T					X7R	0.015 μ	±10, ±20	3.5	200	0.8±0.10	R
HMK107 B7223□A-T					X7R	0.022 μ	±10, ±20	3.5	200	0.8±0.10	R
HMK107 B7333□A-T					X7R	0.033 μ	±10, ±20	3.5	200	0.8±0.10	R
HMK107 B7473□A-T					X7R	0.047 μ	±10, ±20	3.5	200	0.8±0.10	R
HMK107 B7104□A-T					X7R	0.1 μ	±10, ±20	3.5	200	0.8±0.10	R

▶ 由于篇幅有限, 本产品目录中只记载了有代表性的产品规格, 若考虑使用敝公司产品时, 请确认交货规格说明书中的详细规格。  
另外, 有关各产品的详细信息(特性图、可靠性信息、使用时的注意事项等), 请参阅敝公司网站 (<http://www.ty-top.com/>)。

【温度特性 SD: Standard (-55 ~ +125°C)】 0.8mm厚度 (A)

型号1	型号2	额定电压 [V]	温度特性	静电容量 [F]	静电容量允许偏差 [%]	tanδ [%]	高温负载	厚度 <sup>3</sup> [mm]	焊接方式 R: 回流焊 W: 波峰焊
							额定电压 x %		
HMK107 SD101KA-T		100	Standard Type	100 p	±10	0.1	200	0.8±0.10	R
HMK107 SD121KA-T				120 p	±10	0.1	200	0.8±0.10	R
HMK107 SD151KA-T				150 p	±10	0.1	200	0.8±0.10	R
HMK107 SD181KA-T				180 p	±10	0.1	200	0.8±0.10	R
HMK107 SD221KA-T				220 p	±10	0.1	200	0.8±0.10	R
HMK107 SD271KA-T				270 p	±10	0.1	200	0.8±0.10	R
HMK107 SD331KA-T				330 p	±10	0.1	200	0.8±0.10	R
HMK107 SD391KA-T				390 p	±10	0.1	200	0.8±0.10	R
HMK107 SD471KA-T				470 p	±10	0.1	200	0.8±0.10	R
HMK107 SD561KA-T				560 p	±10	0.1	200	0.8±0.10	R
HMK107 SD681KA-T				680 p	±10	0.1	200	0.8±0.10	R
HMK107 SD821KA-T				820 p	±10	0.1	200	0.8±0.10	R
HMK107 SD102KA-T				1000 p	±10	0.1	200	0.8±0.10	R

● 212规格

【温度特性 BJ: B (-25 ~ +85°C) /X5R (-55 ~ +85°C)】 1.25mm厚度 (G)

型号1	型号2	额定电压 [V]	温度特性	静电容量 [F]	静电容量允许偏差 [%]	tanδ [%]	高温负载	厚度 <sup>3</sup> [mm]	焊接方式 R: 回流焊 W: 波峰焊			
							额定电压 x %					
HMK212 BJ103□G-T		100	B	X5R <sup>1</sup>	0.01 μ	±10, ±20	3.5	200	1.25±0.10	R		
HMK212 BJ153□G-T				X5R <sup>1</sup>	0.015 μ	±10, ±20	3.5	200	1.25±0.10	R		
HMK212 BJ223□G-T				X5R <sup>1</sup>	0.022 μ	±10, ±20	3.5	200	1.25±0.10	R		
HMK212 BJ333□G-T				X5R <sup>1</sup>	0.033 μ	±10, ±20	3.5	200	1.25±0.10	R		
HMK212 BJ473□G-T				X5R <sup>1</sup>	0.047 μ	±10, ±20	3.5	200	1.25±0.10	R		
HMK212 BJ683□G-T				X5R <sup>1</sup>	0.068 μ	±10, ±20	3.5	200	1.25±0.10	R		
HMK212 BJ104□G-T				X5R <sup>1</sup>	0.1 μ	±10, ±20	3.5	200	1.25±0.10	R		
HMK212 BJ224□G-T				X5R <sup>1</sup>	0.22 μ	±10, ±20	3.5	200	1.25±0.10	R		
HMK212 BJ474□G-TE				X5R <sup>1</sup>	0.47 μ	±10, ±20	3.5	150	1.25±0.10	R		
HMK212BBJ105□G-TE				X5R <sup>1</sup>	1 μ	±10, ±20	3.5	150	1.25+0.20/-0	R		
QMK212 BJ472□G-T				250	B	X5R <sup>1</sup>	4700 p	±10, ±20	2.5	150	1.25±0.10	R
QMK212 BJ682□G-T						X5R <sup>1</sup>	6800 p	±10, ±20	2.5	150	1.25±0.10	R
QMK212 BJ103□G-T						X5R <sup>1</sup>	0.01 μ	±10, ±20	2.5	150	1.25±0.10	R
QMK212 BJ153□G-T						X5R <sup>1</sup>	0.015 μ	±10, ±20	2.5	150	1.25±0.10	R
QMK212 BJ223□G-T		X5R <sup>1</sup>	0.022 μ			±10, ±20	2.5	150	1.25±0.10	R		

【温度特性 BJ: B (-25 ~ +85°C) /X5R (-55 ~ +85°C)】 0.85mm厚度 (D)

型号1	型号2	额定电压 [V]	温度特性	静电容量 [F]	静电容量允许偏差 [%]	tanδ [%]	高温负载	厚度 <sup>3</sup> [mm]	焊接方式 R: 回流焊 W: 波峰焊	
							额定电压 x %			
QMK212 BJ102□D-T		250	B	X5R <sup>1</sup>	1000 p	±10, ±20	2.5	150	0.85±0.10	R
QMK212 BJ152□D-T				X5R <sup>1</sup>	1500 p	±10, ±20	2.5	150	0.85±0.10	R
QMK212 BJ222□D-T				X5R <sup>1</sup>	2200 p	±10, ±20	2.5	150	0.85±0.10	R
QMK212 BJ332□D-T				X5R <sup>1</sup>	3300 p	±10, ±20	2.5	150	0.85±0.10	R

【温度特性 C7: X7S (-55 ~ +125°C)】 1.25mm厚度 (G)

型号1	型号2	额定电压 [V]	温度特性	静电容量 [F]	静电容量允许偏差 [%]	tanδ [%]	高温负载	厚度 <sup>3</sup> [mm]	焊接方式 R: 回流焊 W: 波峰焊
							额定电压 x %		
HMK212 C7474□G-TE		100	X7S	0.47 μ	±10, ±20	3.5	150	1.25±0.10	R
HMK212BC7105□G-TE		100	X7S	1 μ	±10, ±20	3.5	150	1.25+0.20/-0	R

【温度特性 B7: X7R (-55 ~ +125°C)】 1.25mm厚度 (G)

型号1	型号2	额定电压 [V]	温度特性	静电容量 [F]	静电容量允许偏差 [%]	tanδ [%]	高温负载	厚度 <sup>3</sup> [mm]	焊接方式 R: 回流焊 W: 波峰焊		
							额定电压 x %				
HMK212 B7103□G-T		100	X7R	0.01 μ	±10, ±20	3.5	200	1.25±0.10	R		
HMK212 B7153□G-T				0.015 μ	±10, ±20	3.5	200	1.25±0.10	R		
HMK212 B7223□G-T				0.022 μ	±10, ±20	3.5	200	1.25±0.10	R		
HMK212 B7333□G-T				0.033 μ	±10, ±20	3.5	200	1.25±0.10	R		
HMK212 B7473□G-T				0.047 μ	±10, ±20	3.5	200	1.25±0.10	R		
HMK212 B7683□G-T				0.068 μ	±10, ±20	3.5	200	1.25±0.10	R		
HMK212 B7104□G-T				0.1 μ	±10, ±20	3.5	200	1.25±0.10	R		
HMK212 B7224□G-T				0.22 μ	±10, ±20	3.5	200	1.25±0.10	R		
QMK212 B7472□G-T				250	X7R	4700 p	±10, ±20	2.5	150	1.25±0.10	R
QMK212 B7682□G-T						6800 p	±10, ±20	2.5	150	1.25±0.10	R
QMK212 B7103□G-T						0.01 μ	±10, ±20	2.5	150	1.25±0.10	R
QMK212 B7153□G-T						0.015 μ	±10, ±20	2.5	150	1.25±0.10	R
QMK212 B7223□G-T						0.022 μ	±10, ±20	2.5	150	1.25±0.10	R

【温度特性 B7: X7R (-55 ~ +125°C)】 0.85mm厚度 (D)

型号1	型号2	额定电压 [V]	温度特性	静电容量 [F]	静电容量允许偏差 [%]	tanδ [%]	高温负载	厚度 <sup>3</sup> [mm]	焊接方式 R: 回流焊 W: 波峰焊
							额定电压 x %		
QMK212 B7102□D-T		250	X7R	1000 p	±10, ±20	2.5	150	0.85±0.10	R
QMK212 B7152□D-T				1500 p	±10, ±20	2.5	150	0.85±0.10	R
QMK212 B7222□D-T				2200 p	±10, ±20	2.5	150	0.85±0.10	R
QMK212 B7332□D-T				3300 p	±10, ±20	2.5	150	0.85±0.10	R

▶ 由于篇幅有限, 本产品目录中只记载了有代表性的产品规格, 若考虑使用敝公司产品时, 请确认交货规格说明书中的详细规格。另外, 有关各产品的详细信息(特性图、可靠性信息、使用时的注意事项等), 请参阅敝公司网站(<http://www.ty-top.com/>)。

## ■型号一览

【温度特性 SD: Standard (-55 ~ +125°C)】0.85mm厚度 (D)

型号1	型号2	额定电压 [V]	温度特性	静电容量 [F]	静电容量允许偏差 [%]	tanδ [%]	高温负载	厚度 <sup>-3</sup> [mm]	焊接方式 R: 回流焊 W: 波峰焊
							额定电压 x %		
HMK212 SD222KD-T		100	Standard Type	2200 p	±10	0.1	200	0.85±0.10	R
HMK212 SD472KD-T				4700 p	±10	0.1	200	0.85±0.10	R
QMK212 SD101KD-T				100 p	±10	0.1	150	0.85±0.10	R
QMK212 SD121KD-T				120 p	±10	0.1	150	0.85±0.10	R
QMK212 SD151KD-T				150 p	±10	0.1	150	0.85±0.10	R
QMK212 SD181KD-T				180 p	±10	0.1	150	0.85±0.10	R
QMK212 SD221KD-T				220 p	±10	0.1	150	0.85±0.10	R
QMK212 SD331KD-T				330 p	±10	0.1	150	0.85±0.10	R
QMK212 SD391KD-T				390 p	±10	0.1	150	0.85±0.10	R
QMK212 SD471KD-T				470 p	±10	0.1	150	0.85±0.10	R
QMK212 SD561KD-T				560 p	±10	0.1	150	0.85±0.10	R
QMK212 SD681KD-T				680 p	±10	0.1	150	0.85±0.10	R
QMK212 SD821KD-T				820 p	±10	0.1	150	0.85±0.10	R
QMK212 SD102KD-T				1000 p	±10	0.1	150	0.85±0.10	R

【温度特性 SD: Standard (-55 ~ +125°C)】1.25mm厚度 (G)

型号1	型号2	额定电压 [V]	温度特性	静电容量 [F]	静电容量允许偏差 [%]	tanδ [%]	高温负载	厚度 <sup>-3</sup> [mm]	焊接方式 R: 回流焊 W: 波峰焊
							额定电压 x %		
HMK212 SD392KG-T		100	Standard Type	3900 p	±10	0.1	200	1.25±0.10	R

## ●316规格

【温度特性 BJ: B (-25 ~ +85°C) /X5R (-55 ~ +85°C)】1.6mm厚度 (L)

型号1	型号2	额定电压 [V]	温度特性	静电容量 [F]	静电容量允许偏差 [%]	tanδ [%]	高温负载	厚度 <sup>-3</sup> [mm]	焊接方式 R: 回流焊 W: 波峰焊					
							额定电压 x %							
HMK316 BJ473□L-T		100	B	X5R <sup>+</sup>	0.047 μ	±10, ±20	3.5	200	1.6±0.20	R				
HMK316 BJ683□L-T				X5R <sup>+</sup>	0.068 μ	±10, ±20	3.5	200	1.6±0.20	R				
HMK316 BJ104□L-T				X5R <sup>+</sup>	0.1 μ	±10, ±20	3.5	200	1.6±0.20	R				
HMK316 BJ154□L-T				X5R <sup>+</sup>	0.15 μ	±10, ±20	3.5	200	1.6±0.20	R				
HMK316 BJ224□L-T				X5R <sup>+</sup>	0.22 μ	±10, ±20	3.5	200	1.6±0.20	R				
HMK316 BJ334□L-T				X5R <sup>+</sup>	0.33 μ	±10, ±20	3.5	200	1.6±0.20	R				
HMK316 BJ474□L-T				X5R <sup>+</sup>	0.47 μ	±10, ±20	3.5	200	1.6±0.20	R				
HMK316 BJ105□L-T				X5R <sup>+</sup>	1 μ	±10, ±20	3.5	200	1.6±0.20	R				
HMK316 ABJ225□L-TE				X5R <sup>+</sup>	2.2 μ	±10, ±20	3.5	150	1.6±0.20	R				
QMK316 BJ333□L-T				250	B	X5R <sup>+</sup>	0.033 μ	±10, ±20	2.5	150	1.6±0.20	R		
QMK316 BJ473□L-T						X5R <sup>+</sup>	0.047 μ	±10, ±20	2.5	150	1.6±0.20	R		
QMK316 BJ683□L-T						X5R <sup>+</sup>	0.068 μ	±10, ±20	2.5	150	1.6±0.20	R		
QMK316 BJ104□L-T						X5R <sup>+</sup>	0.1 μ	±10, ±20	2.5	150	1.6±0.20	R		
SMK316 BJ153□L-T						630	B	X5R <sup>+</sup>	0.015 μ	±10, ±20	2.5	120	1.6±0.20	R
SMK316 BJ223□L-T								X5R <sup>+</sup>	0.022 μ	±10, ±20	2.5	120	1.6±0.20	R

【温度特性 BJ: B (-25 ~ +85°C) /X5R (-55 ~ +85°C)】1.15mm厚度 (F)

型号1	型号2	额定电压 [V]	温度特性	静电容量 [F]	静电容量允许偏差 [%]	tanδ [%]	高温负载	厚度 <sup>-3</sup> [mm]	焊接方式 R: 回流焊 W: 波峰焊	
							额定电压 x %			
SMK316 BJ102□F-T		630	B	X5R <sup>+</sup>	1000 p	±10, ±20	2.5	120	1.15±0.10	R
SMK316 BJ152□F-T				X5R <sup>+</sup>	1500 p	±10, ±20	2.5	120	1.15±0.10	R
SMK316 BJ222□F-T				X5R <sup>+</sup>	2200 p	±10, ±20	2.5	120	1.15±0.10	R
SMK316 BJ332□F-T				X5R <sup>+</sup>	3300 p	±10, ±20	2.5	120	1.15±0.10	R
SMK316 BJ472□F-T				X5R <sup>+</sup>	4700 p	±10, ±20	2.5	120	1.15±0.10	R
SMK316 BJ682□F-T				X5R <sup>+</sup>	6800 p	±10, ±20	2.5	120	1.15±0.10	R
SMK316 BJ103□F-T				X5R <sup>+</sup>	0.01 μ	±10, ±20	2.5	120	1.15±0.10	R

【温度特性 C7: X7S (-55 ~ +125°C)】1.6mm厚度 (L)

型号1	型号2	额定电压 [V]	温度特性	静电容量 [F]	静电容量允许偏差 [%]	tanδ [%]	高温负载	厚度 <sup>-3</sup> [mm]	焊接方式 R: 回流焊 W: 波峰焊
							额定电压 x %		
HMK316 AC7225□L-TE		100	X7S	2.2 μ	±10, ±20	3.5	150	1.6±0.20	R

【温度特性 B7: X7R (-55 ~ +125°C)】1.6mm厚度 (L)

型号1	型号2	额定电压 [V]	温度特性	静电容量 [F]	静电容量允许偏差 [%]	tanδ [%]	高温负载	厚度 <sup>-3</sup> [mm]	焊接方式 R: 回流焊 W: 波峰焊				
							额定电压 x %						
HMK316 B7473□L-T		100	X7R	0.047 μ	±10, ±20	3.5	200	1.6±0.20	R				
HMK316 B7683□L-T				0.068 μ	±10, ±20	3.5	200	1.6±0.20	R				
HMK316 B7104□L-T				0.1 μ	±10, ±20	3.5	200	1.6±0.20	R				
HMK316 B7154□L-T				0.15 μ	±10, ±20	3.5	200	1.6±0.20	R				
HMK316 B7224□L-T				0.22 μ	±10, ±20	3.5	200	1.6±0.20	R				
HMK316 B7334□L-T				0.33 μ	±10, ±20	3.5	200	1.6±0.20	R				
HMK316 B7474□L-T				0.47 μ	±10, ±20	3.5	200	1.6±0.20	R				
HMK316 B7105□L-T				1 μ	±10, ±20	3.5	200	1.6±0.20	R				
QMK316 B7333□L-T				250	X7R	0.033 μ	±10, ±20	2.5	150	1.6±0.20	R		
QMK316 B7473□L-T						0.047 μ	±10, ±20	2.5	150	1.6±0.20	R		
QMK316 B7683□L-T						0.068 μ	±10, ±20	2.5	150	1.6±0.20	R		
QMK316 B7104□L-T						0.1 μ	±10, ±20	2.5	150	1.6±0.20	R		
SMK316 B7153□L-T						630	X7R	0.015 μ	±10, ±20	2.5	120	1.6±0.20	R
SMK316 B7223□L-T								0.022 μ	±10, ±20	2.5	120	1.6±0.20	R
SMK316 AB7333□L-T								0.033 μ	±10, ±20	2.5	120	1.6±0.20	R
SMK316 AB7473□L-T								0.047 μ	±10, ±20	2.5	120	1.6±0.20	R

▶ 由于篇幅有限, 本产品目录中只记载了有代表性的产品规格, 若考虑使用敝公司产品时, 请确认交货规格说明书中的详细规格。  
另外, 有关各产品的详细信息(特性图、可靠性信息、使用时的注意事项等), 请参阅敝公司网站 (<http://www.ty-top.com/>)。

【温度特性 B7: X7R (-55 ~ +125°C)】 1.15mm厚度 (F)

型号1	型号2	额定电压 [V]	温度特性		静电容量 [F]	静电容量允许偏差 [%]	tanδ [%]	高温负载	厚度 <sup>3</sup> [mm]	焊接方式 R: 回流焊 W: 波峰焊
								额定电压 x %		
SMK316 B7102[F-T]		630	X7R		1000 p	±10, ±20	2.5	120	1.15±0.10	R
SMK316 B7152[F-T]			X7R		1500 p	±10, ±20	2.5	120	1.15±0.10	R
SMK316 B7222[F-T]			X7R		2200 p	±10, ±20	2.5	120	1.15±0.10	R
SMK316 B7332[F-T]			X7R		3300 p	±10, ±20	2.5	120	1.15±0.10	R
SMK316 B7472[F-T]			X7R		4700 p	±10, ±20	2.5	120	1.15±0.10	R
SMK316 B7682[F-T]			X7R		6800 p	±10, ±20	2.5	120	1.15±0.10	R
SMK316 B7103[F-T]			X7R		0.01 μ	±10, ±20	2.5	120	1.15±0.10	R

【温度特性 SD: Standard (-55 ~ +125°C)】 1.6mm厚度 (L)

型号1	型号2	额定电压 [V]	温度特性		静电容量 [F]	静电容量允许偏差 [%]	tanδ [%]	高温负载	厚度 <sup>3</sup> [mm]	焊接方式 R: 回流焊 W: 波峰焊
								额定电压 x %		
HMK316 SD223KL-T		100	Standard Type		0.022 μ	±10	0.1	200	1.6±0.20	R
QMK316 SD103KL-T		250			0.01 μ	±10	0.1	150	1.6±0.20	R

● 325规格

【温度特性 BJ: B (-25 ~ +85°C) / X5R (-55 ~ +85°C)】 2.5mm厚度 (M)

型号1	型号2	额定电压 [V]	温度特性		静电容量 [F]	静电容量允许偏差 [%]	tanδ [%]	高温负载	厚度 <sup>3</sup> [mm]	焊接方式 R: 回流焊 W: 波峰焊
								额定电压 x %		
HMK325 BJ225[M-P]		100	B	X5R <sup>1</sup>	2.2 μ	±10, ±20	3.5	200	2.5±0.20	R
HMK325 BJ475[M-PE]		100	B	X5R <sup>1</sup>	4.7 μ	±10, ±20	3.5	150	2.5±0.20	R

【温度特性 BJ: B (-25 ~ +85°C) / X5R (-55 ~ +85°C)】 1.9mm厚度 (N)

型号1	型号2	额定电压 [V]	温度特性		静电容量 [F]	静电容量允许偏差 [%]	tanδ [%]	高温负载	厚度 <sup>3</sup> [mm]	焊接方式 R: 回流焊 W: 波峰焊	
								额定电压 x %			
HMK325 BJ154[N-T]		100	B	X5R <sup>1</sup>	0.15 μ	±10, ±20	3.5	200	1.9±0.20	R	
HMK325 BJ224[N-T]			B	X5R <sup>1</sup>	0.22 μ	±10, ±20	3.5	200	1.9±0.20	R	
HMK325 BJ334[N-T]			B	X5R <sup>1</sup>	0.33 μ	±10, ±20	3.5	200	1.9±0.20	R	
HMK325 BJ474[N-T]			B	X5R <sup>1</sup>	0.47 μ	±10, ±20	3.5	200	1.9±0.20	R	
HMK325 BJ684[N-T]			B	X5R <sup>1</sup>	0.68 μ	±10, ±20	3.5	200	1.9±0.20	R	
HMK325 BJ105[N-T]			B	X5R <sup>1</sup>	1 μ	±10, ±20	3.5	200	1.9±0.20	R	
HMK325 BJ475[N-TE]			B	X5R <sup>1</sup>	4.7 μ	±10, ±20	3.5	150	1.9±0.20	R	
QMK325 BJ473[N-T]			B	X5R <sup>1</sup>	0.047 μ	±10, ±20	2.5	150	1.9±0.20	R	
QMK325 BJ104[N-T]			250	B	X5R <sup>1</sup>	0.1 μ	±10, ±20	2.5	150	1.9±0.20	R
QMK325 BJ154[N-T]				B	X5R <sup>1</sup>	0.15 μ	±10, ±20	2.5	150	1.9±0.20	R
QMK325 BJ224[N-T]		B		X5R <sup>1</sup>	0.22 μ	±10, ±20	2.5	150	1.9±0.20	R	
SMK325 BJ223[N-T]		B		X5R <sup>1</sup>	0.022 μ	±10, ±20	2.5	120	1.9±0.20	R	
SMK325 BJ333[N-T]		630	B	X5R <sup>1</sup>	0.033 μ	±10, ±20	2.5	120	1.9±0.20	R	
SMK325 BJ473[N-T]			B	X5R <sup>1</sup>	0.047 μ	±10, ±20	2.5	120	1.9±0.20	R	

【温度特性 BJ: B (-25 ~ +85°C) / X5R (-55 ~ +85°C)】 1.15mm厚度 (F)

型号1	型号2	额定电压 [V]	温度特性		静电容量 [F]	静电容量允许偏差 [%]	tanδ [%]	高温负载	厚度 <sup>3</sup> [mm]	焊接方式 R: 回流焊 W: 波峰焊
								额定电压 x %		
HMK325 BJ104[F-T]		100	B	X5R <sup>1</sup>	0.1 μ	±10, ±20	3.5	200	1.15±0.10	R

【温度特性 B7: X7R (-55 ~ +125°C)】 2.5mm厚度 (M)

型号1	型号2	额定电压 [V]	温度特性		静电容量 [F]	静电容量允许偏差 [%]	tanδ [%]	高温负载	厚度 <sup>3</sup> [mm]	焊接方式 R: 回流焊 W: 波峰焊
								额定电压 x %		
HMK325 B7225[M-P]		100	X7R		2.2 μ	±10, ±20	3.5	200	2.5±0.20	R

【温度特性 B7: X7R (-55 ~ +125°C)】 1.9mm厚度 (N)

型号1	型号2	额定电压 [V]	温度特性		静电容量 [F]	静电容量允许偏差 [%]	tanδ [%]	高温负载	厚度 <sup>3</sup> [mm]	焊接方式 R: 回流焊 W: 波峰焊	
								额定电压 x %			
HMK325 B7154[N-T]		100	X7R		0.15 μ	±10, ±20	3.5	200	1.9±0.20	R	
HMK325 B7224[N-T]			X7R		0.22 μ	±10, ±20	3.5	200	1.9±0.20	R	
HMK325 B7334[N-T]			X7R		0.33 μ	±10, ±20	3.5	200	1.9±0.20	R	
HMK325 B7474[N-T]			X7R		0.47 μ	±10, ±20	3.5	200	1.9±0.20	R	
HMK325 B7684[N-T]			X7R		0.68 μ	±10, ±20	3.5	200	1.9±0.20	R	
HMK325 B7105[N-T]			X7R		1 μ	±10, ±20	3.5	200	1.9±0.20	R	
QMK325 B7473[N-T]			X7R		0.047 μ	±10, ±20	2.5	150	1.9±0.20	R	
QMK325 B7104[N-T]			X7R		0.1 μ	±10, ±20	2.5	150	1.9±0.20	R	
QMK325 B7154[N-T]			250	X7R		0.15 μ	±10, ±20	2.5	150	1.9±0.20	R
QMK325 B7224[N-T]				X7R		0.22 μ	±10, ±20	2.5	150	1.9±0.20	R
SMK325 B7223[N-T]		X7R		0.022 μ	±10, ±20	2.5	120	1.9±0.20	R		
SMK325 B7333[N-T]		X7R		0.033 μ	±10, ±20	2.5	120	1.9±0.20	R		
SMK325 B7473[N-T]		630	X7R		0.047 μ	±10, ±20	2.5	120	1.9±0.20	R	

【温度特性 C7: X7S (-55 ~ +125°C)】 2.5mm厚度 (M)

型号1	型号2	额定电压 [V]	温度特性		静电容量 [F]	静电容量允许偏差 [%]	tanδ [%]	高温负载	厚度 <sup>3</sup> [mm]	焊接方式 R: 回流焊 W: 波峰焊
								额定电压 x %		
HMK325 C7475[M-PE]		100	X7S		4.7 μ	±10, ±20	3.5	150	2.5±0.20	R

【温度特性 C7: X7S (-55 ~ +125°C)】 1.9mm厚度 (N)

型号1	型号2	额定电压 [V]	温度特性		静电容量 [F]	静电容量允许偏差 [%]	tanδ [%]	高温负载	厚度 <sup>3</sup> [mm]	焊接方式 R: 回流焊 W: 波峰焊
								额定电压 x %		
HMK325 C7475[N-TE]		100	X7S		4.7 μ	±10, ±20	3.5	150	1.9±0.20	R

▶ 由于篇幅有限, 本产品目录中只记载了有代表性的产品规格, 若考虑使用敝公司产品时, 请确认交货规格说明书中的详细规格。另外, 有关各产品的详细信息(特性图、可靠性信息、使用时的注意事项等), 请参阅敝公司网站(<http://www.ty-top.com/>)。

## ■ 型号一览

【温度特性 B7 : X7R ( - 55 ~ + 125°C )】 1.15mm厚度 (F)

型号1	型号2	额定电压 [V]	温度特性	静电容量 [F]	静电容量允许偏差 [%]	tanδ [%]	高温负载	厚度 <sup>-3</sup> [mm]	焊接方式 R: 回流焊 W: 波峰焊
							额定电压 x %		
HMK325 B7104□F-T		100	X7R	0.1 μ	±10, ±20	3.5	200	1.15±0.10	R

## ● 432规格

【温度特性 BJ : B ( - 25 ~ + 85°C ) / X5R ( - 55 ~ + 85°C )】 2.5mm厚度 (M)

型号1	型号2	额定电压 [V]	温度特性		静电容量 [F]	静电容量允许偏差 [%]	tanδ [%]	高温负载	厚度 <sup>-3</sup> [mm]	焊接方式 R: 回流焊 W: 波峰焊
								额定电压 x %		
HMK432 BJ474□M-T		100	B	X5R <sup>+</sup>	0.47 μ	±10, ±20	3.5	200	2.5±0.20	R
HMK432 BJ105□M-T			B	X5R <sup>+</sup>	1 μ	±10, ±20	3.5	200	2.5±0.20	R
HMK432 BJ155□M-T			B	X5R <sup>+</sup>	1.5 μ	±10, ±20	3.5	200	2.5±0.20	R
HMK432 BJ225□M-T			B	X5R <sup>+</sup>	2.2 μ	±10, ±20	3.5	200	2.5±0.20	R
QMK432 BJ104□M-T		250	B	X5R <sup>+</sup>	0.1 μ	±10, ±20	2.5	150	2.5±0.20	R
QMK432 BJ224□M-T			B	X5R <sup>+</sup>	0.22 μ	±10, ±20	2.5	150	2.5±0.20	R
QMK432 BJ334□M-T			B	X5R <sup>+</sup>	0.33 μ	±10, ±20	2.5	150	2.5±0.20	R
QMK432 BJ474□M-T			B	X5R <sup>+</sup>	0.47 μ	±10, ±20	2.5	150	2.5±0.20	R
SMK432 BJ473□M-T		630	B	X5R <sup>+</sup>	0.047 μ	±10, ±20	2.5	120	2.5±0.20	R
SMK432 BJ683□M-T			B	X5R <sup>+</sup>	0.068 μ	±10, ±20	2.5	120	2.5±0.20	R
SMK432 BJ104□M-T			B	X5R <sup>+</sup>	0.1 μ	±10, ±20	2.5	120	2.5±0.20	R

【温度特性 B7 : X7R ( - 55 ~ + 125°C )】 2.5mm厚度 (M)

型号1	型号2	额定电压 [V]	温度特性		静电容量 [F]	静电容量允许偏差 [%]	tanδ [%]	高温负载	厚度 <sup>-3</sup> [mm]	焊接方式 R: 回流焊 W: 波峰焊
								额定电压 x %		
HMK432 B7474□M-T		100	X7R		0.47 μ	±10, ±20	3.5	200	2.5±0.20	R
HMK432 B7105□M-T			X7R		1 μ	±10, ±20	3.5	200	2.5±0.20	R
HMK432 B7155□M-T			X7R		1.5 μ	±10, ±20	3.5	200	2.5±0.20	R
HMK432 B7225□M-T			X7R		2.2 μ	±10, ±20	3.5	200	2.5±0.20	R
QMK432 B7104□M-T		250	X7R		0.1 μ	±10, ±20	2.5	150	2.5±0.20	R
QMK432 B7224□M-T			X7R		0.22 μ	±10, ±20	2.5	150	2.5±0.20	R
QMK432 B7334□M-T			X7R		0.33 μ	±10, ±20	2.5	150	2.5±0.20	R
QMK432 B7474□M-T			X7R		0.47 μ	±10, ±20	2.5	150	2.5±0.20	R
SMK432 B7473□M-T		630	X7R		0.047 μ	±10, ±20	2.5	120	2.5±0.20	R
SMK432 B7683□M-T			X7R		0.068 μ	±10, ±20	2.5	120	2.5±0.20	R
SMK432 B7104□M-T			X7R		0.1 μ	±10, ±20	2.5	120	2.5±0.20	R

【温度特性 B7 : X7R ( - 55 ~ + 125°C )】 2.0mm厚度 (Y)

型号1	型号2	额定电压 [V]	温度特性		静电容量 [F]	静电容量允许偏差 [%]	tanδ [%]	高温负载	厚度 <sup>-3</sup> [mm]	焊接方式 R: 回流焊 W: 波峰焊
								额定电压 x %		
XMK432 B7222KY-TE		2000	X7R		2200 p	±10	2.5	110	2.0+0/-0.30	R
XMK432 B7472KY-TE		2000	X7R		4700 p	±10	2.5	110	2.0+0/-0.30	R

▶ 由于篇幅有限, 本产品目录中只记载了有代表性的产品规格, 若考虑使用敝公司产品时, 请确认交货规格说明书中的详细规格。  
另外, 有关各产品的详细信息(特性图、可靠性信息、使用时的注意事项等), 请参阅敝公司网站 (<http://www.ty-top.com/>)。

## LW逆转型多层陶瓷电容器(LWDC™)

### ●105规格

【温度特性 BJ: X5R (-55 ~ +85°C)】 0.3mm厚度 (P)

型号1	型号2	额定电压 [V]	温度特性	静电容量 [F]	静电容量允许偏差 [%]	tanδ [%]	高温负载	厚度 <sup>3</sup> [mm]	焊接方式 R: 回流焊 W: 波峰焊
							额定电压 x %		
TWK105 BJ104MP-F		25	X5R	0.1 μ	±20	5	150	0.3±0.05	R
EWK105 BJ224MP-F		16	X5R	0.22 μ	±20	10	150	0.3±0.05	R
LWK105 BJ474MP-F		10	X5R	0.47 μ	±20	10	150	0.3±0.05	R
JWK105 BJ104MP-F		6.3	X5R <sup>1</sup>	0.1 μ	±20	5	150	0.3±0.05	R
JWK105 BJ474MP-F			X5R <sup>1</sup>	0.47 μ	±20	10	150	0.3±0.05	R
JWK105 BJ105MP-F			X5R	1 μ	±20	10	150	0.3±0.05	R
JWK105 BJ225MP-F			X5R	2.2 μ	±20	10	150	0.3±0.05	R

【温度特性 C6: X6S (-55 ~ +105°C), C7: X7S (-55 ~ +125°C)】 0.3mm厚度 (P)

型号1	型号2	额定电压 [V]	温度特性	静电容量 [F]	静电容量允许偏差 [%]	tanδ [%]	高温负载	厚度 <sup>3</sup> [mm]	焊接方式 R: 回流焊 W: 波峰焊
							额定电压 x %		
EWK105 C6104MP-F		16	X6S	0.1 μ	±20	5	150	0.3±0.05	R
LWK105 C7104MP-F		10	X7S	0.1 μ	±20	5	150	0.3±0.05	R
LWK105 C6224MP-F			X6S	0.22 μ	±20	10	150	0.3±0.05	R
JWK105 C7104MP-F		6.3	X7S	0.1 μ	±20	5	150	0.3±0.05	R
JWK105 C7224MP-F			X7S	0.22 μ	±20	10	150	0.3±0.05	R
JWK105 C6474MP-F			X6S	0.47 μ	±20	10	150	0.3±0.05	R
AWK105 C6224MP-F			X6S	0.22 μ	±20	10	150	0.3±0.05	R
AWK105 C6474MP-F		4	X6S	0.47 μ	±20	10	150	0.3±0.05	R
AWK105 C6105MP-F			X6S	1 μ	±20	10	150	0.3±0.05	R
AWK105 C6225MP-F			X6S	2.2 μ	±20	10	150	0.3±0.05	R

### ●107规格

【温度特性 BJ: X5R (-55 ~ +85°C)】 0.5mm厚度 (V)

型号1	型号2	额定电压 [V]	温度特性	静电容量 [F]	静电容量允许偏差 [%]	tanδ [%]	高温负载	厚度 <sup>3</sup> [mm]	焊接方式 R: 回流焊 W: 波峰焊
							额定电压 x %		
TWK107 BJ104MV-T		25	X5R <sup>1</sup>	0.1 μ	±20	5	150	0.5±0.05	R
EWK107 BJ224MV-T		16	X5R <sup>1</sup>	0.22 μ	±20	5	150	0.5±0.05	R
EWK107 BJ474MV-T			X5R <sup>1</sup>	0.47 μ	±20	5	150	0.5±0.05	R
LWK107 BJ105MV-T		10	X5R	1 μ	±20	10	150	0.5±0.05	R
LWK107 BJ225MV-T			X5R	2.2 μ	±20	10	150	0.5±0.05	R
JWK107 BJ105MV-T		6.3	X5R <sup>1</sup>	1 μ	±20	10	150	0.5±0.05	R
JWK107 BJ225MV-T			X5R	2.2 μ	±20	10	150	0.5±0.05	R
JWK107 BJ475MV-T			X5R	4.7 μ	±20	10	150	0.5±0.05	R
AWK107 BJ106MV-T			X5R	10 μ	±20	10	150	0.5±0.05	R

【温度特性 B7: X7R (-55 ~ +125°C), C6: X6S (-55 ~ +105°C), C7: X7S (-55 ~ +125°C)】 0.5mm厚度 (V)

型号1	型号2	额定电压 [V]	温度特性	静电容量 [F]	静电容量允许偏差 [%]	tanδ [%]	高温负载	厚度 <sup>3</sup> [mm]	焊接方式 R: 回流焊 W: 波峰焊
							额定电压 x %		
TWK107 B7104MV-T		25	X7R	0.1 μ	±20	5	150	0.5±0.05	R
EWK107 B7224MV-T		16	X7R	0.22 μ	±20	5	150	0.5±0.05	R
EWK107 B7474MV-T			X7R	0.47 μ	±20	5	150	0.5±0.05	R
JWK107 C7105MV-T		6.3	X7S	1 μ	±20	10	150	0.5±0.05	R
AWK107 C7225MV-T		4	X7S	2.2 μ	±20	10	150	0.5±0.05	R
AWK107 C6475MV-T			X6S	4.7 μ	±20	10	150	0.5±0.05	R
PWK107 C6106MV-T		2.5	X6S	10 μ	±20	10	150	0.5±0.05	R

### ●212规格

【温度特性 BJ: X5R (-55 ~ +85°C)】 0.85mm厚度 (D)

型号1	型号2	额定电压 [V]	温度特性	静电容量 [F]	静电容量允许偏差 [%]	tanδ [%]	高温负载	厚度 <sup>3</sup> [mm]	焊接方式 R: 回流焊 W: 波峰焊
							额定电压 x %		
TWK212 BJ475[D]-T		25	X5R	4.7 μ	±10, ±20	10	150	0.85±0.10	R
EWK212 BJ106MD-T		16	X5R	10 μ	±20	10	150	0.85±0.10	R
LWK212 BJ475[D]-T		10	X5R	4.7 μ	±10, ±20	10	150	0.85±0.10	R
LWK212 BJ106MD-T			X5R	10 μ	±20	10	150	0.85±0.10	R
JWK212 BJ226MD-T		6.3	X5R	22 μ	±20	10	150	0.85±0.10	R

【温度特性 B7: X7R (-55 ~ +125°C), C6: X6S (-55 ~ +105°C)】 0.85mm厚度 (D)

型号1	型号2	额定电压 [V]	温度特性	静电容量 [F]	静电容量允许偏差 [%]	tanδ [%]	高温负载	厚度 <sup>3</sup> [mm]	焊接方式 R: 回流焊 W: 波峰焊
							额定电压 x %		
TWK212 B7225[D]-T		25	X7R	2.2 μ	±10, ±20	5	150	0.85±0.10	R
EWK212 C6475[D]-T		16	X6S	4.7 μ	±10, ±20	10	150	0.85±0.10	R
LWK212 C6106MD-T		10	X6S	10 μ	±20	10	150	0.85±0.10	R
AWK212 C6226MD-T		4	X6S	22 μ	±20	10	150	0.85±0.10	R

▶ 由于篇幅有限, 本产品目录中只记载了有代表性的产品规格, 若考虑使用敝公司产品时, 请确认交货规格说明书中的详细规格。另外, 有关各产品的详细信息(特性图、可靠性信息、使用时的注意事项等), 请参阅敝公司网站(<http://www.ty-top.com/>)。

# Multilayer Ceramic Capacitors

## PACKAGING

### ① Minimum Quantity

#### ● Taped package

Type(EIA)	Thickness		Standard quantity [pcs]	
	mm	code	Paper tape	Embossed tape
<input type="checkbox"/> MK021(008004)	0.125	K	—	50000
<input type="checkbox"/> VS021(008004)				
<input type="checkbox"/> MK042(01005)	0.2	C, D	—	40000
<input type="checkbox"/> VS042(01005)				
<input type="checkbox"/> MK063(0201)	0.3	P, T	15000	—
<input type="checkbox"/> WK105(0204) ※	0.3	P	10000	—
<input type="checkbox"/> MK105(0402) <input type="checkbox"/> MF105(0402)	0.13	H	—	20000
	0.18	E	—	15000
	0.2	C	20000	—
	0.3	P	15000	—
	0.5	V	10000	—
<input type="checkbox"/> VK105(0402)	0.5	W	10000	—
<input type="checkbox"/> MK107(0603)	0.45	K	4000	—
<input type="checkbox"/> WK107(0306) ※	0.5	V	—	4000
<input type="checkbox"/> MF107(0603)	0.8	A	4000	—
<input type="checkbox"/> VS107(0603)	0.7	C	4000	—
<input type="checkbox"/> MJ107(0603)	0.8	A	3000	3000
<input type="checkbox"/> MK212(0805)	0.45	K	4000	—
<input type="checkbox"/> WK212(0508) ※	0.85	D		
<input type="checkbox"/> MF212(0805)	1.25	G	—	3000
<input type="checkbox"/> VS212(0805)	0.85	D	4000	—
<input type="checkbox"/> MJ212(0805)	0.85	D	4000	—
	1.25	G	—	2000
<input type="checkbox"/> MK316(1206) <input type="checkbox"/> MF316(1206)	0.85	D	4000	—
	1.15	F	—	3000
	1.6	L	—	2000
<input type="checkbox"/> MJ316(1206)	1.15	F	—	3000
	1.6	L	—	2000
<input type="checkbox"/> MK325(1210) <input type="checkbox"/> MF325(1210)	0.85	D	—	2000
	1.15	F		
	1.9	N		
	2.0max.	Y		
<input type="checkbox"/> MJ325(1210)	2.5	M	—	1000
	1.9	N	—	2000
	2.5	M	—	500(T), 1000(P)
<input type="checkbox"/> MK432(1812)	2.5	M	—	500

Note : ※ LW Reverse type.

### ② Taping material

※No bottom tape for pressed carrier tape

#### ● Card board carrier tape

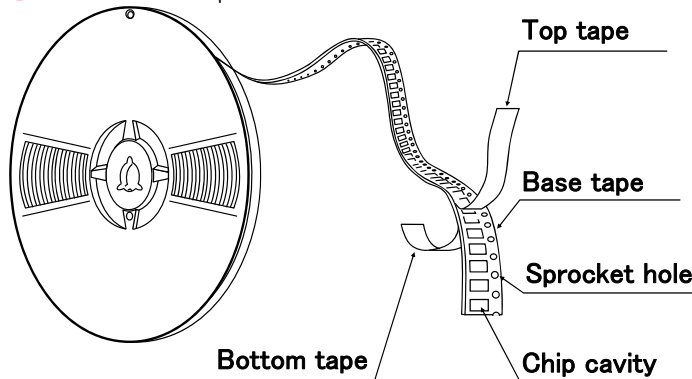

#### ● Embossed tape

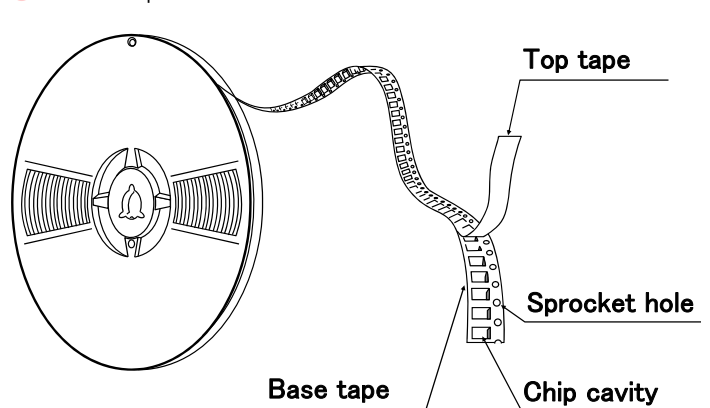

▶ This catalog contains the typical specification only due to the limitation of space. When you consider the purchase of our products, please check our specification. For details of each product (characteristics graph, reliability information, precautions for use, and so on), see our Web site (<http://www.ty-top.com/>).

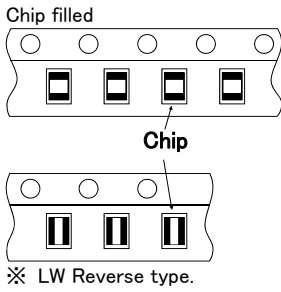

### ③ Representative taping dimensions

● Paper Tape (8mm wide)

● Pressed carrier tape ( 2mm pitch)

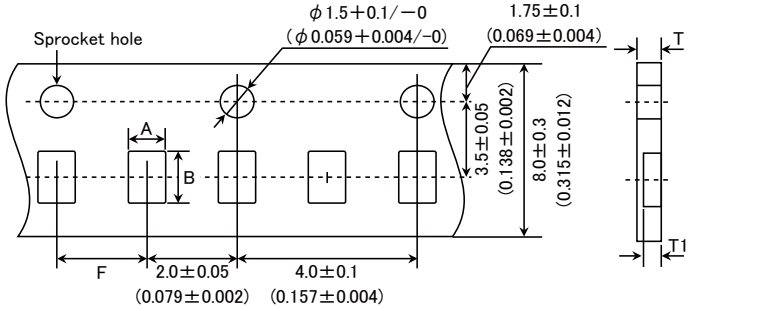

Type(EIA)	Chip Cavity		Insertion Pitch F	Tape Thickness	
	A	B		T	T1
□MK063(0201)	0.37	0.67	2.0±0.05	0.45max.	0.42max.
□WK105(0204) ※	0.65	1.15		0.4max.	0.3max.
□MK105(0402) (*1 C)				0.45max.	0.42max.
□MK105(0402) (*1 P)					

Note \*1 Thickness, C: 0.2mm ,P: 0.3mm. ※ LW Reverse type.

Unit: mm

● Punched carrier tape (2mm pitch)

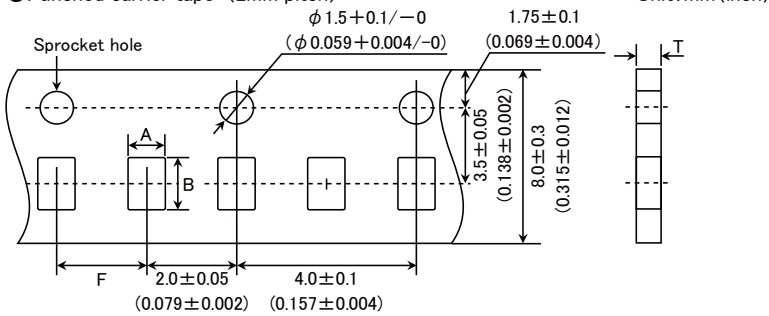

Type(EIA)	Chip Cavity		Insertion Pitch F	Tape Thickness
	A	B		T
□MK105 (0402)	0.65	1.15	2.0±0.05	0.8max.
□MF105 (0402)				
□VK105 (0402)				

Unit: mm

● Punched carrier tape (4mm pitch)

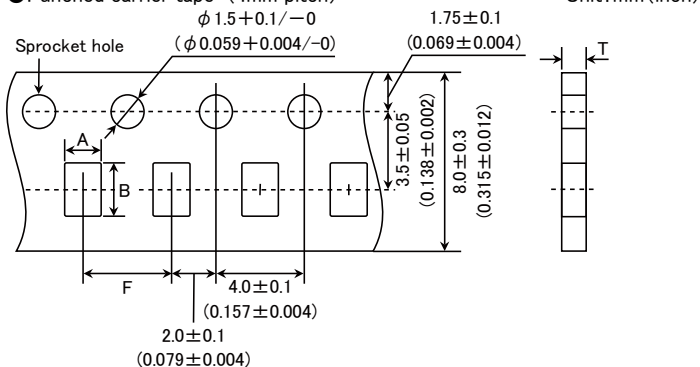

▶ This catalog contains the typical specification only due to the limitation of space. When you consider the purchase of our products, please check our specification. For details of each product (characteristics graph, reliability information, precautions for use, and so on), see our Web site (<http://www.ty-top.com/>).



Type(EIA)	Chip Cavity		Insertion Pitch	Tape Thickness
	A	B	F	T
□MK107(0603) □WK107(0306) ※ □MF107(0603)	1.0	1.8	4.0±0.1	1.1max.
□MK212(0805) □WK212(0508) ※ □MK316(1206)	1.65	2.4		1.1max.
	2.0	3.6		

Note: Taping size might be different depending on the size of the product. ※ LW Reverse type.

Unit: mm

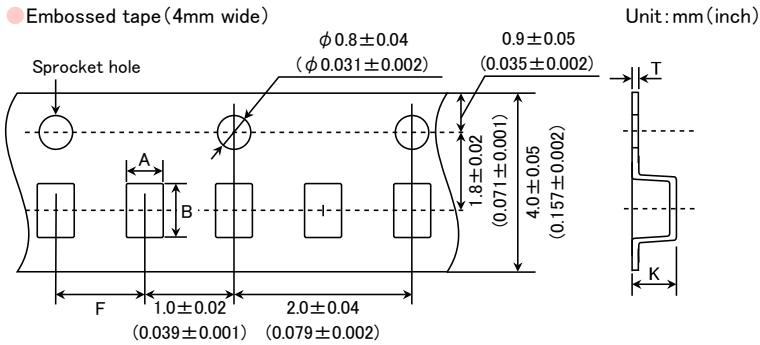

Type(EIA)	Chip Cavity		Insertion Pitch	Tape Thickness	
	A	B	F	K	T
□MK021(008004) □VS021(008004) □MK042(01005) □VS042(01005)	0.135	0.27	1.0±0.02	0.5max.	0.25max.

Unit: mm

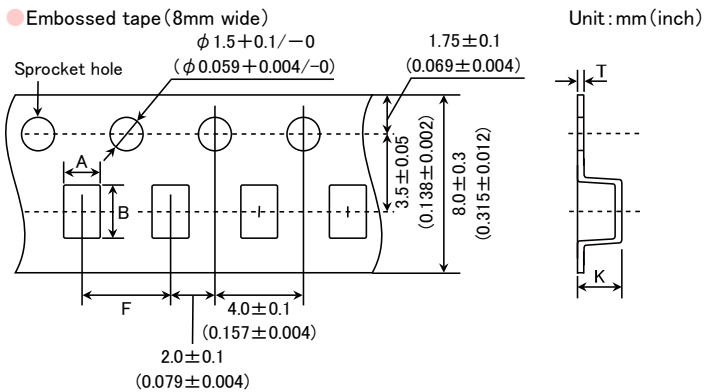

Type(EIA)	Chip Cavity		Insertion Pitch	Tape Thickness	
	A	B	F	K	T
□MK105(0402) □WK107(0306) ※ □MK212(0805) □MF212(0805)	0.6	1.1	2.0±0.1	0.6max.	0.2±0.1
□MK316(1206) □MF316(1206)	2.0	3.6	4.0±0.1	3.4max.	0.6max.
□MK325(1210) □MF325(1210)	2.8	3.6			

Note: ※ LW Reverse type.

Unit: mm

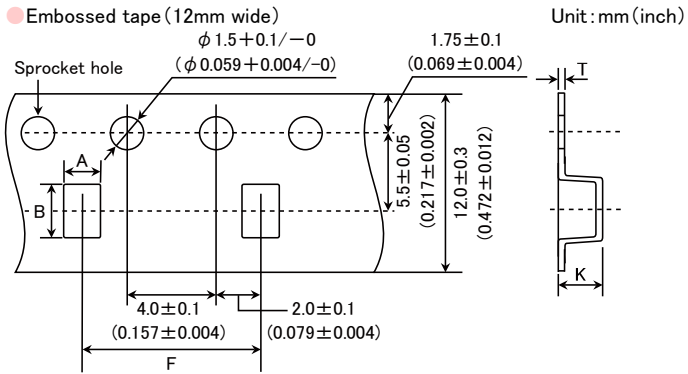

Type(EIA)	Chip Cavity		Insertion Pitch	Tape Thickness	
	A	B	F	K	T
□MK325(1210)	3.1	4.0	8.0±0.1	4.0max.	0.6max.
□MK432(1812)	3.7	4.9	8.0±0.1	4.0max.	0.6max.

Unit: mm

#### ④Trailer and Leader

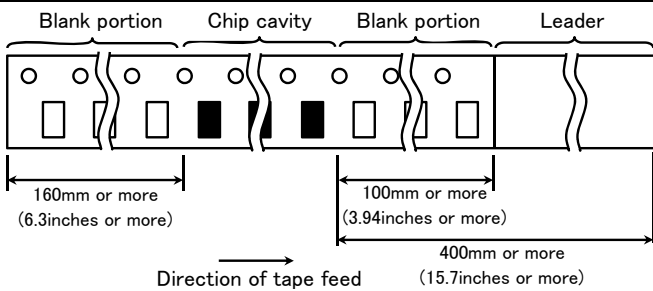

#### ⑤Reel size

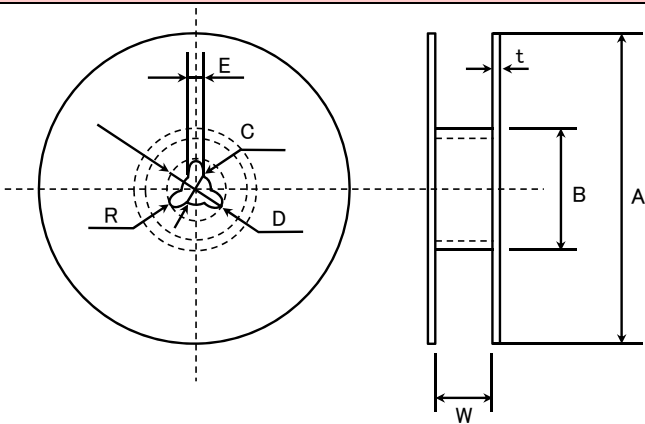

A	B	C	D	E	R
$\phi 178 \pm 2.0$	$\phi 50 \text{ min.}$	$\phi 13.0 \pm 0.2$	$\phi 21.0 \pm 0.8$	$2.0 \pm 0.5$	1.0
	T	W			
4mm wide tape	1.5max.	$5 \pm 1.0$			
8mm wide tape	2.5max.	$10 \pm 1.5$			
12mm wide tape	2.5max.	$14 \pm 1.5$			

Unit: mm

#### ⑥Top Tape Strength

The top tape requires a peel-off force of 0.1 to 0.7N in the direction of the arrow as illustrated below.

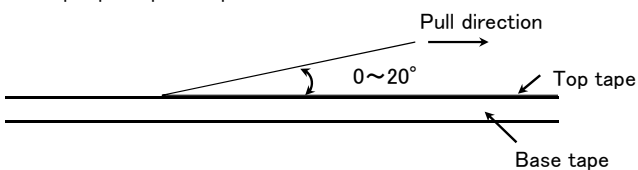

# Multilayer Ceramic Capacitors

## RELIABILITY DATA

### 1. Operating Temperature Range

Specified Value	Temperature Compensating(Class1)	Standard	-55 to +125°C	
		High Frequency Type		
Specified Value	High Permittivity (Class2)		Specification	Temperature Range
		BJ	B	-25 to +85°C
			X5R	-55 to +85°C
		B7	X7R	-55 to +125°C
		C6	X6S	-55 to +105°C
		C7	X7S	-55 to +125°C
	LD(※)	X5R	-55 to +85°C	

Note: ※LD Low distortion high value multilayer ceramic capacitor

### 2. Storage Conditions

Specified Value	Temperature Compensating(Class1)	Standard	-55 to +125°C	
		High Frequency Type		
Specified Value	High Permittivity (Class2)		Specification	Temperature Range
		BJ	B	-25 to +85°C
			X5R	-55 to +85°C
		B7	X7R	-55 to +125°C
		C6	X6S	-55 to +105°C
		C7	X7S	-55 to +125°C
	LD(※)	X5R	-55 to +85°C	

Note: ※LD Low distortion high value multilayer ceramic capacitor

### 3. Rated Voltage

Specified Value	Temperature Compensating(Class1)	Standard	50VDC, 25VDC, 16VDC
		High Frequency Type	50VDC, 25VDC, 16VDC
	High Permittivity (Class2)		50VDC, 35VDC, 25VDC, 16VDC, 10VDC, 6.3VDC, 4VDC, 2.5VDC

### 4. Withstanding Voltage (Between terminals)

Specified Value	Temperature Compensating(Class1)	Standard	No breakdown or damage
		High Frequency Type	
Test Methods and Remarks	High Permittivity (Class2)		
		Class 1	Class 2
	Applied voltage	Rated voltage × 3	Rated voltage × 2.5
	Duration	1 to 5 sec.	
	Charge/discharge current	50mA max.	

### 5. Insulation Resistance

Specified Value	Temperature Compensating(Class1)	Standard	10000 MΩ min.
		High Frequency Type	
Specified Value	High Permittivity (Class2) Note 1		C ≤ 0.047 F : 10000 MΩ min. C > 0.047 μF : 500MΩ · μF
	Test Methods and Remarks	Applied voltage : Rated voltage Duration : 60 ± 5 sec. Charge/discharge current : 50mA max.	

▶ This catalog contains the typical specification only due to the limitation of space. When you consider the purchase of our products, please check our specification. For details of each product (characteristics graph, reliability information, precautions for use, and so on), see our Web site (<http://www.ty-top.com/>).

6. Capacitance (Tolerance)

Specified Value	Temperature Compensating(Class1)	Standard	C□	0.2pF ≤ C ≤ 5pF	: ±0.25pF	
			U□	0.2pF ≤ C ≤ 10pF	: ±0.5pF	
	High Frequency Type	CG	0.2pF ≤ C ≤ 2pF	: ±0.1pF	C > 2pF	: ±5%
High Permittivity (Class2)		±10% or ±20%				
Test Methods and Remarks			Class 1		Class 2	
			Standard	High Frequency Type	C ≤ 10 μF	C > 10 μF
	Preconditioning		None		Thermal treatment (at 150°C for 1hr) Note 2	
	Measuring frequency		1MHz ± 10%		1kHz ± 10%	120 ± 10Hz
	Measuring voltage Nte		0.5 to 5Vrms		1 ± 0.2Vrms	0.5 ± 0.1Vrms
Bias application		None				

7. Q or Dissipation Factor

Specified Value	Temperature Compensating(Class1)	Standard	C < 30pF : Q ≥ 400 + 20C C ≥ 30pF : Q ≥ 1000 (C: Nominal capacitance)			
			High Frequency Type	Refer to detailed specification		
	High Permittivity (Class2) Note 1		BJ, B7, C6, C7: 2.5% max.			
Test Methods and Remarks			Class 1		Class 2	
			Standard	High Frequency Type	C ≤ 10 μF	C > 10 μF
	Preconditioning		None		Thermal treatment (at 150°C for 1hr) Note 2	
	Measuring frequency		1MHz ± 10%	1GHz	1kHz ± 10%	120 ± 10Hz
	Measuring voltage Note 1		0.5 to 5Vrms		1 ± 0.2Vrms	0.5 ± 0.1Vrms
Bias application		None				
High Frequency Type		Measuring equipment : HP4291A Measuring jig : HP16192A				

8. Temperature Characteristic (Without voltage application)

Specified Value	Temperature Compensating(Class1)	Standard	Temperature Characteristic [ppm/°C]		Tolerance [ppm/°C]	
			C□ : 0	CG	G : ±30	
	U□ : -750	UJ, UK	J : ±120 K : ±250			
High Permittivity (Class2)	High Frequency Type		Temperature Characteristic [ppm/°C]		Tolerance [ppm/°C]	
			C□ : 0	CG	G : ±30	
		Specification	Capacitance change	Reference temperature	Temperature Range	
	BJ	B	±10%	20°C	-25 to +85°C	
		X5R	±15%	25°C	-55 to +85°C	
	B7	X7R	±15%	25°C	-55 to +125°C	
	C6	XS	±22%	25°C	-55 to +105°C	
	C7	X7S	±22%	25°C	-55 to +125°C	
	LD(※)	X5R	±15%	25°C	-55 to +85°C	
	Note : ※LD Low distortion high value multilayer ceramic capacitor					
Test Methods and Remarks	Class 1 Capacitance at 20°C and 85°C shall be measured in thermal equilibrium, and the temperature characteristic shall be calculated from the following equation.					
	$\frac{(C_{85} - C_{20})}{C_{20} \times \Delta T} \times 10^6 (\text{ppm}/^\circ\text{C}) \quad \Delta T = 65$					
	Class 2 Capacitance at each step shall be measured in thermal equilibrium, and the temperature characteristic shall be calculated from the following equation.					
	Step		B	X5R, X7R, X6S, X7S		
	1	Minimum operating temperature				
2	20°C		25°C			
3	Maximum operating temperature					
$\frac{(C - C_2)}{C_2} \times 100 (\%)$						
C : Capacitance in Step 1 or Step 3 C <sub>2</sub> : Capacitance in Step 2						

▶ This catalog contains the typical specification only due to the limitation of space. When you consider the purchase of our products, please check our specification. For details of each product (characteristics graph, reliability information, precautions for use, and so on), see our Web site (<http://www.ty-top.com/>).

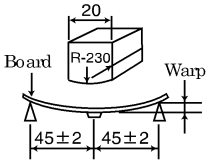
9. Deflection																				
Specified Value	Temperature Compensating(Class1)	Standard	Appearance : No abnormality Capacitance change : Within $\pm 5\%$ or $\pm 0.5$ pF, whichever is larger.																	
		High Frequency Type	Appearance : No abnormality Capacitance change : Within $\pm 0.5$ pF																	
	High Permittivity (Class2)		Appearance : No abnormality Capacitance change : Within $\pm 12.5\%$																	
Test Methods and Remarks	<table border="1"> <thead> <tr> <th rowspan="2"></th> <th colspan="2">Multilayer Ceramic Capacitors</th> </tr> <tr> <th>021, 042, 063, *105 Type</th> <th>The other types</th> </tr> </thead> <tbody> <tr> <td>Board</td> <td colspan="2">Glass epoxy-resin substrate</td> </tr> <tr> <td>Thickness</td> <td>0.8mm</td> <td>1.6mm</td> </tr> <tr> <td>Warp</td> <td colspan="2">1mm</td> </tr> <tr> <td>Duration</td> <td colspan="2">10 sec.</td> </tr> </tbody> </table> <p>*105 Type thickness, C: 0.2mm ,P: 0.3mm.</p>			Multilayer Ceramic Capacitors		021, 042, 063, *105 Type	The other types	Board	Glass epoxy-resin substrate		Thickness	0.8mm	1.6mm	Warp	1mm		Duration	10 sec.		 <p>(Unit: mm)</p> <p>Capacitance measurement shall be conducted with the board bent</p>
		Multilayer Ceramic Capacitors																		
021, 042, 063, *105 Type		The other types																		
Board	Glass epoxy-resin substrate																			
Thickness	0.8mm	1.6mm																		
Warp	1mm																			
Duration	10 sec.																			

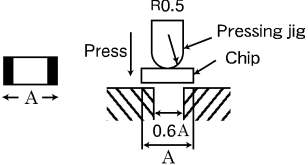
10. Body Strength			
Specified Value	Temperature Compensating(Class1)	Standard	—
		High Frequency Type	No mechanical damage.
	High Permittivity (Class2)		—
Test Methods and Remarks	High Frequency 105Type Applied force : 5N Duration : 10 sec.		

11. Adhesive Strength of Terminal Electrodes														
Specified Value	Temperature Compensating(Class1)	Standard	No terminal separation or its indication.											
		High Frequency Type												
	High Permittivity (Class2)													
Test Methods and Remarks	<table border="1"> <thead> <tr> <th rowspan="2"></th> <th colspan="2">Multilayer Ceramic Capacitors</th> </tr> <tr> <th>021, 042, 063 Type</th> <th>105 Type or more</th> </tr> </thead> <tbody> <tr> <td>Applied force</td> <td>2N</td> <td>5N</td> </tr> <tr> <td>Duration</td> <td colspan="2">30±5 sec.</td> </tr> </tbody> </table>			Multilayer Ceramic Capacitors		021, 042, 063 Type	105 Type or more	Applied force	2N	5N	Duration	30±5 sec.		
		Multilayer Ceramic Capacitors												
		021, 042, 063 Type	105 Type or more											
Applied force	2N	5N												
Duration	30±5 sec.													

12. Solderability																		
Specified Value	Temperature Compensating(Class1)	Standard	At least 95% of terminal electrode is covered by new solder.															
		High Frequency Type																
	High Permittivity (Class2)																	
Test Methods and Remarks	<table border="1"> <thead> <tr> <th rowspan="2"></th> <th colspan="2">Eutectic solder</th> <th>Lead-free solder</th> </tr> <tr> <th>H60A or H63A</th> <th></th> <th>Sn-3.0Ag-0.5Cu</th> </tr> </thead> <tbody> <tr> <td>Solder type</td> <td colspan="2">230±5°C</td> <td>245±3°C</td> </tr> <tr> <td>Solder temperature</td> <td colspan="3">4±1 sec.</td> </tr> </tbody> </table>			Eutectic solder		Lead-free solder	H60A or H63A		Sn-3.0Ag-0.5Cu	Solder type	230±5°C		245±3°C	Solder temperature	4±1 sec.			
		Eutectic solder		Lead-free solder														
		H60A or H63A		Sn-3.0Ag-0.5Cu														
	Solder type	230±5°C		245±3°C														
Solder temperature	4±1 sec.																	

▶ This catalog contains the typical specification only due to the limitation of space. When you consider the purchase of our products, please check our specification. For details of each product (characteristics graph, reliability information, precautions for use, and so on), see our Web site (<http://www.ty-top.com/>).

**13. Resistance to Soldering**

Specified Value	Temperature Compensating(Class1)	Standard	Appearance : No abnormality Capacitance change : Within $\pm 2.5\%$ or $\pm 0.25\text{pF}$ , whichever is larger. Q : Initial value Insulation resistance : Initial value Withstanding voltage (between terminals) : No abnormality
		High Frequency Type	Appearance : No abnormality Capacitance change : Within $\pm 2.5\%$ Q : Initial value Insulation resistance : Initial value Withstanding voltage (between terminals) : No abnormality
	High Permittivity (Class2) Note 1		Appearance : No abnormality Capacitance change : Within $\pm 7.5\%$ Dissipation factor : Initial value Insulation resistance : Initial value Withstanding voltage (between terminals): No abnormality

Test Methods and Remarks	Class 1			
		021, 042, 063 Type	105 Type	
	Preconditioning	None		
	Preheating	150°C, 1 to 2 min.	80 to 100°C, 2 to 5 min. 150 to 200°C, 2 to 5 min.	
	Solder temp.	270 $\pm$ 5°C		
	Duration	3 $\pm$ 0.5 sec.		
	Recovery	6 to 24 hrs (Standard condition) Note 5		
	Class 2			
		021, 042, 063 Type	105, 107, 212 Type	316, 325, 432 Type
	Preconditioning	Thermal treatment (at 150°C for 1 hr) Note 2		
	Preheating	150°C, 1 to 2 min.	80 to 100°C, 2 to 5 min. 150 to 200°C, 2 to 5 min.	80 to 100°C, 5 to 10 min. 150 to 200°C, 5 to 10 min.
	Solder temp.	270 $\pm$ 5°C		
	Duration	3 $\pm$ 0.5 sec.		
	Recovery	24 $\pm$ 2 hrs (Standard condition) Note 5		

**14. Temperature Cycle (Thermal Shock)**

Specified Value	Temperature Compensating(Class1)	Standard	Appearance : No abnormality Capacitance change : Within $\pm 2.5\%$ or $\pm 0.25\text{pF}$ , whichever is larger. Q : Initial value Insulation resistance : Initial value Withstanding voltage (between terminals) : No abnormality
		High Frequency Type	Appearance : No abnormality Capacitance change : Within $\pm 0.25\text{pF}$ Q : Initial value Insulation resistance : Initial value Withstanding voltage (between terminals) : No abnormality
	High Permittivity (Class2) Note 1		Appearance : No abnormality Capacitance change : Within $\pm 7.5\%$ Dissipation factor : Initial value Insulation resistance : Initial value Withstanding voltage (between terminals) : No abnormality

Test Methods and Remarks	Class 1		Class 2		
	Preconditioning	None		Thermal treatment (at 150°C for 1 hr) Note 2	
	1 cycle	Step	Temperature (°C)	Time (min.)	
		1	Minimum operating temperature	30 $\pm$ 3	
		2	Normal temperature	2 to 3	
3		Maximum operating temperature	30 $\pm$ 3		
4	Normal temperature	2 to 3			
Number of cycles	5 times				
Recovery	6 to 24 hrs (Standard condition) Note 5		24 $\pm$ 2 hrs (Standard condition) Note 5		

▶ This catalog contains the typical specification only due to the limitation of space. When you consider the purchase of our products, please check our specification. For details of each product (characteristics graph, reliability information, precautions for use, and so on), see our Web site (<http://www.ty-top.com/>).

15. Humidity (Steady State)				
Specified Value	Temperature Compensating(Class1)	Standard	Appearance : No abnormality Capacitance change : Within $\pm 5\%$ or $\pm 0.5\text{pF}$ , whichever is larger. Q : $C < 10\text{pF} : Q \geq 200 + 10C$ $10 \leq C < 30\text{pF} : Q \geq 275 + 2.5C$ $C \geq 30\text{pF} : Q \geq 350 (C : \text{Nominal capacitance})$ Insulation resistance : $1000 \text{ M}\Omega$ min.	
		High Frequency Type	Appearance : No abnormality Capacitance change : Within $\pm 0.5\text{pF}$ , Insulation resistance : $1000 \text{ M}\Omega$ min.	
	High Permittivity (Class2) Note 1		Appearance : No abnormality Capacitance change : Within $\pm 12.5\%$ Dissipation factor : $5.0\%$ max. Insulation resistance : $50 \text{ M}\Omega \mu\text{F}$ or $1000 \text{ M}\Omega$ whichever is smaller.	
Test Methods and Remarks		Class 1		Class 2
		Standard	High Frequency Type	All items
	Preconditioning	None		Thermal treatment ( at $150^\circ\text{C}$ for 1 hr) Note 2
	Temperature	$40 \pm 2^\circ\text{C}$	$60 \pm 2^\circ\text{C}$	$40 \pm 2^\circ\text{C}$
	Humidity	90 to 95%RH		90 to 95%RH
	Duration	$500 + 24 / - 0$ hrs		$500 + 24 / - 0$ hrs
	Recovery	6 to 24 hrs (Standard condition) Note 5		$24 \pm 2$ hrs (Standard condition) Note 5

16. Humidity Loading				
Specified Value	Temperature Compensating(Class1)	Standard	Appearance : No abnormality Capacitance change : Within $\pm 7.5\%$ or $\pm 0.75\text{pF}$ , whichever is larger. Q : $C < 30\text{pF} : Q \geq 100 + 10C/3$ $C \geq 30\text{pF} : Q \geq 200 (C : \text{Nominal capacitance})$ Insulation resistance : $500 \text{ M}\Omega$ min.	
		High Frequency Type	Appearance : No abnormality Capacitance change : $C \leq 2\text{pF} : \text{Within } \pm 0.4 \text{ pF}$ $C > 2\text{pF} : \text{Within } \pm 0.75 \text{ pF}$ (C:Nominal capacitance) Insulation resistance : $500 \text{ M}\Omega$ min.	
	High Permittivity (Class2) Note 1		Appearance : No abnormality Capacitance change : Within $\pm 12.5\%$ Dissipation factor : $5.0\%$ max. Insulation resistance : $25 \text{ M}\Omega \mu\text{F}$ or $500 \text{ M}\Omega$ , whichever is smaller.	
Test Methods and Remarks		Class 1		Class 2
		Standard	High Frequency Type	All items
	Preconditioning	None		Voltage treatment (Rated voltage are applied for 1 hour at $40^\circ\text{C}$ ) Note 3
	Temperature	$40 \pm 2^\circ\text{C}$	$60 \pm 2^\circ\text{C}$	$40 \pm 2^\circ\text{C}$
	Humidity	90 to 95%RH		90 to 95%RH
	Duration	$500 + 24 / - 0$ hrs		$500 + 24 / - 0$ hrs
	Applied voltage	Rated voltage		Rated voltage
	Charge/discharge current	50mA max.		50mA max.
Recovery	6 to 24 hrs (Standard condition) Note 5		$24 \pm 2$ hrs (Standard condition) Note 5	

► This catalog contains the typical specification only due to the limitation of space. When you consider the purchase of our products, please check our specification.  
For details of each product (characteristics graph, reliability information, precautions for use, and so on), see our Web site (<http://www.ty-top.com/>).

17. High Temperature Loading

Specified Value	Temperature Compensating(Class1)	Standard	Appearance : No abnormality Capacitance change : Within $\pm 3\%$ or $\pm 0.3\text{pF}$ , whichever is larger. Q : $C < 10\text{pF}$ : $Q \geq 200 + 10C$ $10 \leq C < 30\text{pF}$ : $Q \geq 275 + 2.5C$ $C \geq 30\text{pF}$ : $Q \geq 350$ (C: Nominal capacitance) Insulation resistance : 1000 M $\Omega$ min.
		High Frequency Type	Appearance : No abnormality Capacitance change : Within $\pm 3\%$ or $\pm 0.3\text{pF}$ , whichever is larger. Insulation resistance : 1000 M $\Omega$ min.
	High Permittivity (Class2) Note 1		Appearance : No abnormality Capacitance change : Within $\pm 12.5\%$ Dissipation factor : 5.0% max. Insulation resistance : 50 M $\Omega$ $\mu\text{F}$ or 1000 M $\Omega$ , whichever is smaller.

Test Methods and Remarks		Class 1		Class 2		
		Standard	High Frequency Type	BJ, LD(※)	C6	B7, C7
	Preconditioning	None		Voltage treatment (Twice the rated voltage shall be applied for 1 hour at 85°C, 105°C or 125°C) Note 3, 4		
	Temperature	Maximum operating temperature		Maximum operating temperature		
	Duration	1000+48/-0 hrs		1000+48/-0 hrs		
	Applied voltage	Rated voltage $\times 2$ Note 4		Rated voltage $\times 2$ Note 4		
	Charge/discharge current	50mA max.		50mA max.		
	Recovery	6 to 24hr (Standard condition) Note 5		24 $\pm 2$ hrs (Standard condition) Note 5		
Note: ※LD Low distortion high value multilayer ceramic capacitor						

Note 1 The figures indicate typical specifications. Please refer to individual specifications in detail.

Note 2 Thermal treatment : Initial value shall be measured after test sample is heat-treated at 150+0/-10°C for an hour and kept at room temperature for 24 $\pm 2$ hours.

Note 3 Voltage treatment : Initial value shall be measured after test sample is voltage-treated for an hour at both the temperature and voltage specified in the test conditions, and kept at room temperature for 24 $\pm 2$ hours.

Note 4 150% of rated voltage is applicable to some items. Please refer to their specifications for further information.

Note 5 Standard condition: Temperature: 5 to 35°C, Relative humidity: 45 to 85 % RH, Air pressure: 86 to 106kPa When there are questions concerning measurement results, in order to provide correlation data, the test shall be conducted under the following condition.  
Temperature: 20 $\pm 2$ °C, Relative humidity: 60 to 70 % RH, Air pressure: 86 to 106kPa Unless otherwise specified, all the tests are conducted under the "standard condition".



# Super Low Distortion Multilayer Ceramic Capacitors

## RELIABILITY DATA

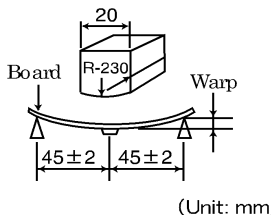
<b>1. Operating Temperature Range</b>	
Specified Value	-55 to +125°C
<b>2. Storage Temperature Range</b>	
Specified Value	-55 to +125°C
<b>3. Rated Voltage</b>	
Specified Value	6.3VDC, 10VDC, 16VDC, 25VDC, 35VDC, 50VDC
<b>4. Dielectric Withstanding Voltage (Between terminals)</b>	
Specified Value	No breakdown or damage
Test Methods and Remarks	Applied voltage : Rated voltage × 3 Duration : 1 to 5 sec. Charge/discharge current : 50mA max.
<b>5. Insulation Resistance</b>	
Specified Value	10000 MΩ or 500MΩ μ F, whichever is smaller
Test Methods and Remarks	Applied voltage : Rated voltage Duration : 60±5 sec. Charge/discharge current : 50mA max.
<b>6. Capacitance (Tolerance)</b>	
Specified Value	±10%
Test Methods and Remarks	Measuring frequency : 1kHz±10% Measuring voltage : 1±0.2Vrms Bias application : None
<b>7. Dissipation Factor</b>	
Specified Value	0.1%max
Test Methods and Remarks	Measuring frequency : 1kHz±10% Measuring voltage : 1±0.2Vrms Bias application : None
<b>8. Bending Strength</b>	
Specified Value	Appearance : No abnormality Capacitance change : ±5%
Test Methods and Remarks	Warp : 1mm Speed : 0.5mm/second Duration : 10 seconds Test board : glass epoxy resin substrate Thickness : 1.6mm
	 <p>(Unit: mm)</p>
	Capacitance measurement shall be conducted with the board bent.
<b>9. Adhesive Force of Terminal Electrodes</b>	
Specified Value	Terminal electrodes shall be no exfoliation or a sign of exfoliation.
Test Methods and Remarks	Applied force : 5N Duration : 30 ±5 seconds

▶ This catalog contains the typical specification only due to the limitation of space. When you consider the purchase of our products, please check our specification. For details of each product (characteristics graph, reliability information, precautions for use, and so on), see our Web site (<http://www.ty-top.com/>).

10. Solderability			
Specified Value	At least 95% of terminal electrode is covered by new solder.		
Test Methods and Remarks		Eutectic solder	Lead-free solder
	Solder type	H60A or H63A	Sn-3.0Ag-0.5Cu
	Solder temperature	230±5°C	245±3°C
	Duration	4±1 sec.	
11. Resistance to Soldering Heat			
Specified Value	Appearance	: No abnormality	
	Capacitance change	: ±2.5% max.	
	Dissipation factor	: Initial value	
	Insulation resistance	: Initial value	
	Withstanding voltage	(between terminals) : No abnormality	
Test Methods and Remarks	Solder temp.	: 270 ±5°C	
	Duration	: 3 ±0.5 sec.	
	Preheating conditions	: 80 to 100°C, 2 to 5 min. or 5 to 10 min. 150 to 200°C, 2 to 5 min. or 5 to 10 min.	
	Measurement shall be conducted	: 24±2hrs under the standard condition Note1	
12. Temperature Cycle (Thermal Shock)			
Specified Value	Appearance	: No abnormality	
	Capacitance change	: ±2.5% max	
	Dissipation factor	: Initial value	
	Insulation resistance	: Initial value	
	Withstanding voltage	(between terminals): No abnormality	
Test Methods and Remarks	Conditions for 1 cycle		
	Step	temperature (°C)	Time (min.)
	1	Minimum operating temperature	30±3 min.
	2	Normal temperature	2 to 3 min.
	3	Maximum operating temperature	30±3 min.
	4	Normal temperature	2 to 3 min.
Number of cycles: 5 times			
Measurement shall be conducted : 24±2hrs under the standard condition Note1			
13. Humidity (Steady state)			
Specified Value	Appearance	: No abnormality	
	Capacitance change	: ±5% max	
	Dissipation factor	: 0.5% max	
	Insulation resistance	: 50MΩ μ F or 1000MΩ , whichever is smaller	
Test Methods and Remarks	Temperature	: 40±2°C	
	Humidity	: 90 to 95% RH	
	Duration	: 500 +24/-0 hrs	
	Measurement shall be conducted	: 24 ±2hrs under the standard condition Note1	
14. Humidity Loading			
Specified Value	Appearance	: No abnormality	
	Capacitance change	: ±7.5% max	
	Dissipation factor	: 0.5% max	
	Insulation resistance	: 25MΩ μ F or 500MΩ , whichever is smaller	
Test Methods and Remarks	According to JIS C 5101-1.		
	Temperature	: 40±2°C	
	Humidity	: 90 to 95% RH	
	Duration	: 500 +24/-0 hrs	
	Applied voltage	: Rated voltage	
	Charge/discharge current	: 50mA max	
	Measurement shall be conducted	: 24 ±2hrs under the standard condition Note1	

▶ This catalog contains the typical specification only due to the limitation of space. When you consider the purchase of our products, please check our specification.  
For details of each product (characteristics graph, reliability information, precautions for use, and so on), see our Web site (<http://www.ty-top.com/>).

## 15. High Temperature Loading

Specified Value	Appearance	: No abnormality
	Capacitance change	: $\pm 3\%$ max
	Dissipation factor	: 0.35% max
	Insulation resistance	: $50M\Omega \mu F$ or $1000M\Omega$ , whichever is smaller
Test Methods and Remarks	According to JIS C 5101-1.	
	Temperature	: Maximum operating temperature
	Duration	: 1000 +48/-0 hrs
	Applied voltage	: Rated voltage x 2
	Charge/discharge current	: 50mA max
Measurement shall be conducted	: 24 $\pm$ 2hrs under the standard condition	Note1

Note1 Standard condition: Temperature: 5 to 35°C, Relative humidity: 45 to 85 % RH, Air pressure: 86 to 106kPa

When there are questions concerning measurement results, in order to provide correlation data, the test shall be conducted under the following condition.

Temperature: 20 $\pm$ 2°C, Relative humidity: 60 to 70 % RH, Air pressure: 86 to 106kPa

Unless otherwise specified, all the tests are conducted under the "standard condition".

## Medium-High Voltage Multilayer Ceramic Capacitor

### RELIABILITY DATA

1. Operating Temperature Range		
Specified Value	Temperature Compensating(Class1)	CG : -55 to +125°C
	High Permittivity (Class2)	X7R, X7S : -55 to +125°C X5R : -55 to +85°C B : -25 to +85°C SD : -55 to +125°C
2. Storage Temperature Range		
Specified Value	Temperature Compensating(Class1)	CG : -55 to +125°C
	High Permittivity (Class2)	X7R, X7S : -55 to +125°C X5R : -55 to +85°C B : -25 to +85°C SD : -55 to +125°C
3. Rated Voltage		
Specified Value	Temperature Compensating(Class1)	100VDC(HMK)
	High Permittivity (Class2)	100VDC(HMK), 250VDC(QMK), 630VDC(SMK), 2000VDC(XMK)
4. Withstanding Voltage(Between terminals)		
Specified Value	No breakdown or damage	
Test Methods and Remarks	Applied voltage : Rated voltage × 2.5(HMK), Rated voltage × 2(QMK), Rated voltage × 1.2(SMK)(XMK) Duration : 1 to 5sec. Charge/discharge current : 50mA max.	
5. Insulation Resistance		
Specified Value	Temperature Compensating(Class1)	10000 MΩ min.
	High Permittivity (Class2)	100MΩ · μF or 10GΩ, whichever is smaller.
Test Methods and Remarks	Applied voltage : Rated voltage(HMK, QMK), 500V(SMK,XMK) Duration : 60±5sec. Charge/discharge current : 50mA max.	
6. Capacitance (Tolerance)		
Specified Value	Temperature Compensating(Class1)	0.2pF ≤ C ≤ 5pF : ±0.25pF 0.2pF ≤ C ≤ 10pF : ±0.5pF C > 10pF : ±5% or ±10%
	High Permittivity (Class2)	±10%, ±20%
Test Methods and Remarks	Temperature Compensating(Class1)	Measuring frequency : 1MHz ± 10% Measuring voltage : 0.5~5Vrms Bias application : None
	High Permittivity (Class2)	Measuring frequency : 1kHz ± 10% Measuring voltage : 1 ± 0.2Vrms Bias application : None
7. Q or Dissipation Factor		
Specified Value	Temperature Compensating(Class1)	C < 30pF : Q ≥ 400 + 20C C ≥ 30pF : Q ≥ 1000 (C: Nominal capacitance)
	High Permittivity (Class2)	3.5%max(HMK), 2.5%max(QMK, SMK)
Test Methods and Remarks	Temperature Compensating(Class1)	Measuring frequency : 1MHz ± 10% Measuring voltage : 0.5~5Vrms Bias application : None
	High Permittivity (Class2)	Measuring frequency : 1kHz ± 10% Measuring voltage : 1 ± 0.2Vrms Bias application : None

▶ This catalog contains the typical specification only due to the limitation of space. When you consider the purchase of our products, please check our specification. For details of each product (characteristics graph, reliability information, precautions for use, and so on), see our Web site (<http://www.ty-top.com/>).

8. Temperature Characteristic of Capacitance													
Specified Value	Temperature Compensating(Class1)	CG : $0 \pm 30 \text{ ppm}/^\circ\text{C} (-55 \text{ to } +125^\circ\text{C})$											
	High Permittivity (Class2)	B : $\pm 10\% (-25 \text{ to } +85^\circ\text{C})$ X5R : $\pm 15\% (-55 \text{ to } +85^\circ\text{C})$ X7R : $\pm 15\% (-55 \text{ to } +125^\circ\text{C})$ X7S : $\pm 22\% (-55 \text{ to } +125^\circ\text{C})$ SD : - ( $-55 \text{ to } +125^\circ\text{C})$											
Test Methods and Remarks	Class 1 Capacitance at $20^\circ\text{C}$ and $85^\circ\text{C}$ shall be measured in thermal equilibrium, and the temperature characteristic shall be calculated from the following equation. $\frac{(C_{85} - C_{20})}{C_{20} \times \Delta T} \times 10^6 (\text{ppm}/^\circ\text{C}) \quad \Delta T = 65$												
	Class 2 Capacitance at each step shall be measured in thermal equilibrium, and the temperature characteristic shall be calculated from the following equation. <table border="1" style="margin-left: 20px;"> <thead> <tr> <th>Step</th> <th>B</th> <th>X5R, X7R, X6S, X7S</th> </tr> </thead> <tbody> <tr> <td>1</td> <td colspan="2">Minimum operating temperature</td> </tr> <tr> <td>2</td> <td><math>20^\circ\text{C}</math></td> <td><math>25^\circ\text{C}</math></td> </tr> <tr> <td>3</td> <td colspan="2">Maximum operating temperature</td> </tr> </tbody> </table> $\frac{(C - C_2)}{C_2} \times 100 (\%)$ <p>C : Capacitance value in Step 1 or Step 3 C2 : Capacitance value in Step 2</p>		Step	B	X5R, X7R, X6S, X7S	1	Minimum operating temperature		2	$20^\circ\text{C}$	$25^\circ\text{C}$	3	Maximum operating temperature
Step	B	X5R, X7R, X6S, X7S											
1	Minimum operating temperature												
2	$20^\circ\text{C}$	$25^\circ\text{C}$											
3	Maximum operating temperature												

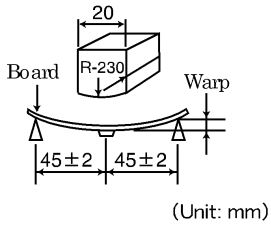
9. Deflection		
Specified Value	Temperature Compensating(Class1)	Appearance : No abnormality Capacitance change : Within $\pm 5\%$ or $\pm 0.5 \text{ pF}$ , whichever is larger.
	High Permittivity (Class2)	Appearance : No abnormality Capacitance change : Within $\pm 10\%$
Test Methods and Remarks	Warp : 1mm Duration : 10sec. Test board : Glass epoxy-resin substrate Thickness : 1.6mm	
	Capacitance measurement shall be conducted with the board bent.	

10. Adhesive Strength of Terminal Electrodes		
Specified Value	Temperature Compensating(Class1)	No terminal separation or its indication.
	High Permittivity (Class2)	
Test Methods and Remarks	Applied force : 5N Duration : $30 \pm 5 \text{ sec.}$	

11. Solderability			
Specified Value	Temperature Compensating(Class1)	At least 95% of terminal electrode is covered by new solder	
	High Permittivity (Class2)		
Test Methods and Remarks		Eutectic solder	Lead-free solder
	Solder type	H60A or H63A	Sn-3.0Ag-0.5Cu
	Solder temperature	$230 \pm 5^\circ\text{C}$	$245 \pm 3^\circ\text{C}$
	Duration	$4 \pm 1 \text{ sec.}$	

▶ This catalog contains the typical specification only due to the limitation of space. When you consider the purchase of our products, please check our specification. For details of each product (characteristics graph, reliability information, precautions for use, and so on), see our Web site (<http://www.ty-top.com/>).

12. Resistance to Soldering		
Specified Value	Temperature Compensating(Class1)	Appearance : No abnormality Capacitance change : Within $\pm 2.5\%$ or $\pm 0.25\text{pF}$ , whichever is larger.(HMK) Q : Initial value Insulation resistance : Initial value Withstanding voltage (between terminals) : No abnormality
	High Permittivity (Class2)	Appearance : No abnormality Capacitance change : Within $\pm 15\%$ (HMK), $\pm 10\%$ (QMK, SMK, XMK) Dissipation facto : Initial value Insulation resistance : Initial value Withstanding voltage (between terminals) : No abnormality
Test Methods and Remarks	Temperature Compensating(Class1)	
	Preconditioning	None
	Solder temperature	$270 \pm 5^\circ\text{C}$
	Duration	$3 \pm 0.5\text{sec.}$
	Preheating conditions	80 to $100^\circ\text{C}$ , 2 to 5 min. 150 to $200^\circ\text{C}$ , 2 to 5min.
	Recovery	$24 \pm 2\text{hrs}$ under the standard condition Note3
	High Permittivity (Class2)	
	Preconditioning	Thermal treatment(at $150^\circ\text{C}$ for 1hr) Note1
	Solder temperature	$270 \pm 5^\circ\text{C}$
	Duration	$3 \pm 0.5\text{sec.}$
	Preheating conditions	80 to $100^\circ\text{C}$ , 2 to 5 min. 150 to $200^\circ\text{C}$ , 2 to 5min.
	Recovery	$24 \pm 2\text{hrs}$ under the standard condition Note3

13. Temperature Cycle (Thermal Shock)			
Specified Value	Temperature Compensating(Class1)	Appearance : No abnormality Capacitance change : Within $\pm 2.5\%$ or $\pm 0.25\text{pF}$ , whichever is larger.(HMK) Q : Initial value Insulation resistance : Initial value Withstanding voltage (between terminals) : No abnormality	
	High Permittivity (Class2)	Appearance : No abnormality Capacitance change : Within $\pm 15\%$ (HMK), $\pm 10\%$ (QMK, SMK, XMK) Dissipation facto : Initial value Insulation resistance : Initial value Withstanding voltage (between terminals) : No abnormality	
Test Methods and Remarks	Class 1		
	Preconditioning	None	
	1 cycle	Step	Temperature ( $^\circ\text{C}$ )
		1	Minimum operating temperature
		2	Normal temperature
		3	Maximum operating temperature
	4	Normal temperature	
Number of cycles	5 times		
Recovery	6 to 24 hrs (Standard condition) Note 3	$24 \pm 2$ hrs (Standard condition) Note 3	

14. Humidity (Steady state)		
Specified Value	Temperature Compensating(Class1)	Appearance : No abnormality Capacitance change : Within $\pm 5\%$ or $\pm 0.5\text{pF}$ , whichever is larger.(HMK) Q : $C < 10\text{pF}$ : $Q \geq 200 + 10C$ $10 \leq C < 30\text{pF}$ : $Q \geq 275 + 2.5C$ $C \geq 30\text{pF}$ : $Q \geq 350(C : \text{Nominal capacitance})$ Insulation resistance : $1000\text{M}\Omega$ min.
	High Permittivity (Class2)	Appearance : No abnormality Capacitance change : Within $\pm 15\%$ Dissipation factor : $7\%\text{max}$ (HMK), $5\%\text{max}$ (QMK, SMK, XMK). Insulation resistance : $25\text{M}\Omega$ $\mu\text{F}$ or $1000\text{M}\Omega$ , whichever is smaller.
Test Methods and Remarks	Class 1	
	Preconditioning	None
	Temperature	$40 \pm 2^\circ\text{C}$
	Humidity	90 to 95%RH
	Duration	$500 + 24 / - 0$ hrs
	Recovery	6 to 24 hrs (Standard condition) Note 3
Class 2		
Preconditioning	Thermal treatment( at $150^\circ\text{C}$ for 1 hr) Note 1	
Temperature	$40 \pm 2^\circ\text{C}$	
Humidity	90 to 95%RH	
Duration	$500 + 24 / - 0$ hrs	
Recovery	$24 \pm 2$ hrs (Standard condition) Note 3	

► This catalog contains the typical specification only due to the limitation of space. When you consider the purchase of our products, please check our specification.  
For details of each product (characteristics graph, reliability information, precautions for use, and so on), see our Web site (<http://www.ty-top.com/>).

15. Humidity Loading			
Specified Value	Temperature Compensating(Class1)	Appearance	: No abnormality
		Capacitance change	: Within $\pm 7.5\%$ or $\pm 0.75\text{pF}$ , whichever is larger (HMK).
		Q	: $C < 30\text{pF} : Q \geq 100 + 10C/3$ $C \geq 30\text{pF} : Q \geq 200$ (C: Nominal capacitance)
		Insulation resistance	: $500 \text{ M}\Omega$ min.
	High Permittivity (Class2)	Appearance	: No abnormality
		Capacitance change	: Within $\pm 15\%$
		Dissipation factor	: $7\% \text{max}$ (HMK), $5\% \text{max}$ (QMK, SMK, XMK).
		Insulation resistance	: $10 \text{ M}\Omega \mu\text{F}$ or $500 \text{ M}\Omega$ , whichever is smaller.
Test Methods and Remarks	According to JIS 5101-1.		
		Class 1	Class 2
	Preconditioning	None	Voltage treatment (Rated voltage are applied for 1 hour at $40^\circ\text{C}$ ) Note 2
	Temperature	$40 \pm 2^\circ\text{C}$	$40 \pm 2^\circ\text{C}$
	Humidity	90 to 95%RH	90 to 95%RH
	Duration	$500 + 24 / - 0$ hrs	$500 + 24 / - 0$ hrs
	Applied voltage	Rated voltage	Rated voltage
	Charge/discharge current	50mA max.	50mA max.
	Recovery	6 to 24 hrs (Standard condition) Note 3	$24 \pm 2$ hrs (Standard condition) Note 3

16. High Temperature Loading			
Specified Value	Temperature Compensating(Class1)	Appearance	: No abnormality
		Capacitance change	: Within $\pm 7.5\%$ or $\pm 0.75\text{pF}$ , whichever is larger.(HMK)
		Q	: $C < 30\text{pF} : Q \geq 100 + 10C/3$ $C \geq 30\text{pF} : Q \geq 200$ (C: Nominal capacitance)
		Insulation resistance	: $500 \text{ M}\Omega$ min.
	High Permittivity (Class2)	Appearance	: No abnormality
		Capacitance change	: Within $\pm 15\%$
		Dissipation factor	: $7\% \text{max}$ (HMK), $5\% \text{max}$ (QMK, SMK, XMK).
		Insulation resistance	: $50 \text{ M}\Omega \mu\text{F}$ or $1000 \text{ M}\Omega$ , whichever is smaller.
Test Methods and Remarks	According to JIS 5101-1.		
		Class 1	Class 2
	Preconditioning	None	Voltage treatment Note 2
	Temperature	Maximum operating temperature	Maximum operating temperature
	Duration	$1000 + 48 / - 0$ hrs	$1000 + 48 / - 0$ hrs
	Applied voltage	Rated voltage $\times 2$ (HMK)	Rated voltage $\times 2$ (HMK), Rated voltage $\times 1.5$ (QMK), Rated voltage $\times 1.2$ (SMK, XMK)
	Charge/discharge current	50mA max.	50mA max.
	Recovery	6 to 24hr (Standard condition) Note 3	$24 \pm 2$ hrs (Standard condition) Note 3

Note1 Thermal treatment : Initial value shall be measured after test sample is heat-treated at  $150 \pm 0 / - 10^\circ\text{C}$  for an hour and kept at room temperature for  $24 \pm 2$  hours.

Note2 Voltage treatment : Initial value shall be measured after test sample is voltage-treated for an hour at both the temperature and voltage specified in the test conditions, and kept at room temperature for  $24 \pm 2$  hours.

Note3 Standard condition : Temperature: 5 to  $35^\circ\text{C}$ , Relative humidity: 45 to 85 % RH, Air pressure: 86 to 106kPa

When there are questions concerning measurement results, in order to provide correlation data, the test shall be conducted under the following condition.

Temperature:  $20 \pm 2^\circ\text{C}$ , Relative humidity: 60 to 70 % RH, Air pressure: 86 to 106kPa

Unless otherwise specified, all the tests are conducted under the "standard condition".

# Precautions on the use of Multilayer Ceramic Capacitors

## PRECAUTIONS

### 1. Circuit Design

**◆Verification of operating environment, electrical rating and performance**

1. A malfunction of equipment in fields such as medical, aerospace, nuclear control, etc. may cause serious harm to human life or have severe social ramifications.  
Therefore, any capacitors to be used in such equipment may require higher safety and reliability, and shall be clearly differentiated from them used in general purpose applications.

**◆Operating Voltage (Verification of Rated voltage)**

1. The operating voltage for capacitors must always be their rated voltage or less.  
If an AC voltage is loaded on a DC voltage, the sum of the two peak voltages shall be the rated voltage or less.  
For a circuit where an AC or a pulse voltage may be used, the sum of their peak voltages shall also be the rated voltage or less.
2. Even if an applied voltage is the rated voltage or less reliability of capacitors may be deteriorated in case that either a high frequency AC voltage or a pulse voltage having rapid rise time is used in a circuit.

### 2. PCB Design

**◆Pattern configurations (Design of Land-patterns)**

1. When capacitors are mounted on PCBs, the amount of solder used (size of fillet) can directly affect the capacitor performance.  
Therefore, the following items must be carefully considered in the design of land patterns:
  - (1) Excessive solder applied can cause mechanical stresses which lead to chip breaking or cracking. Therefore, please consider appropriate land-patterns for proper amount of solder.
  - (2) When more than one component are jointly soldered onto the same land, each component's soldering point shall be separated by solder-resist.

**◆Pattern configurations (Capacitor layout on PCBs)**

After capacitors are mounted on boards, they can be subjected to mechanical stresses in subsequent manufacturing processes (PCB cutting, board inspection, mounting of additional parts, assembly into the chassis, wave soldering of the boards, etc.). For this reason, land pattern configurations and positions of capacitors shall be carefully considered to minimize stresses.

**◆Pattern configurations (Design of Land-patterns)**

The following diagrams and tables show some examples of recommended land patterns to prevent excessive solder amounts.

(1) Recommended land dimensions for typical chip capacitors

● Multilayer Ceramic Capacitors : Recommended land dimensions (unit: mm)

Wave-soldering

Type		107	212	316	325
Size	L	1.6	2.0	3.2	3.2
	W	0.8	1.25	1.6	2.5
A		0.8 to 1.0	1.0 to 1.4	1.8 to 2.5	1.8 to 2.5
B		0.5 to 0.8	0.8 to 1.5	0.8 to 1.7	0.8 to 1.7
C		0.6 to 0.8	0.9 to 1.2	1.2 to 1.6	1.8 to 2.5

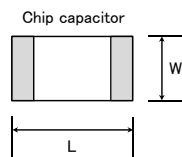
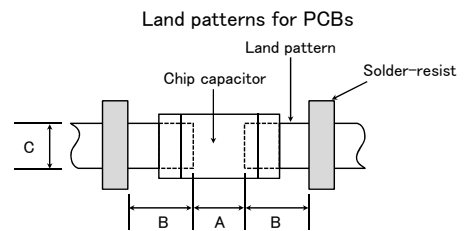

Reflow-soldering

Type		021	042	063	105	107	212	316	325	432
Size	L	0.25	0.4	0.6	1.0	1.6	2.0	3.2	3.2	4.5
	W	0.125	0.2	0.3	0.5	0.8	1.25	1.6	2.5	3.2
A		0.095~0.135	0.15~0.25	0.20~0.30	0.45~0.55	0.6~0.8	0.8~1.2	1.8~2.5	1.8~2.5	2.5~3.5
B		0.085~0.125	0.10~0.20	0.20~0.30	0.40~0.50	0.6~0.8	0.8~1.2	1.0~1.5	1.0~1.5	1.5~1.8
C		0.110~0.150	0.15~0.30	0.25~0.40	0.45~0.55	0.6~0.8	0.9~1.6	1.2~2.0	1.8~3.2	2.3~3.5

Note: Recommended land size might be different according to the allowance of the size of the product.

● LWDC: Recommended land dimensions for reflow-soldering (unit: mm)

Type		105	107	212
Size	L	0.52	0.8	1.25
	W	1.0	1.6	2.0
A		0.18~0.22	0.25~0.3	0.5~0.7
B		0.2~0.25	0.3~0.4	0.4~0.5
C		0.9~1.1	1.5~1.7	1.9~2.1

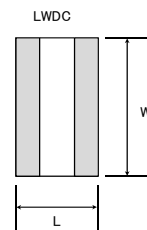

▶ This catalog contains the typical specification only due to the limitation of space. When you consider the purchase of our products, please check our specification. For details of each product (characteristics graph, reliability information, precautions for use, and so on), see our Web site (<http://www.ty-top.com/>).



(2) Examples of good and bad solder application

Item	Not recommended	Recommended
Mixed mounting of SMD and leaded components		
Component placement close to the chassis		
Hand-soldering of leaded components near mounted components		
Horizontal component placement		

◆ Pattern configurations (Capacitor layout on PCBs)

1-1. The following is examples of good and bad capacitor layouts ; capacitors shall be located to minimize any possible mechanical stresses from board warp or deflection.

Items	Not recommended	Recommended
Deflection of board		 Place the product at a right angle to the direction of the anticipated mechanical stress.

1-2. The amount of mechanical stresses given will vary depending on capacitor layout. Please refer to diagram below.



1-3. When PCB is split, the amount of mechanical stress on the capacitors can vary according to the method used. The following methods are listed in order from least stressful to most stressful: push-back, slit, V-grooving, and perforation. Thus, please consider the PCB, split methods as well as chip location.

3. Mounting

Precautions

◆ Adjustment of mounting machine

- When capacitors are mounted on PCB, excessive impact load shall not be imposed on them.
- Maintenance and inspection of mounting machines shall be conducted periodically.

◆ Selection of Adhesives

- When chips are attached on PCBs with adhesives prior to soldering, it may cause capacitor characteristics degradation unless the following factors are appropriately checked : size of land patterns, type of adhesive, amount applied, hardening temperature and hardening period. Therefore, please contact us for further information.

◆Adjustment of mounting machine

1. When the bottom dead center of a pick-up nozzle is too low, excessive force is imposed on capacitors and causes damages. To avoid this, the following points shall be considerable.
  - (1) The bottom dead center of the pick-up nozzle shall be adjusted to the surface level of PCB without the board deflection.
  - (2) The pressure of nozzle shall be adjusted between 1 and 3 N static loads.
  - (3) To reduce the amount of deflection of the board caused by impact of the pick-up nozzle, supporting pins or back-up pins shall be used on the other side of the PCB. The following diagrams show some typical examples of good and bad pick-up nozzle placement:

Item	Improper method	Proper method
Single-sided mounting		
Double-sided mounting		

Technical considerations

2. As the alignment pin is worn out, adjustment of the nozzle height can cause chipping or cracking of capacitors because of mechanical impact on the capacitors. To avoid this, the monitoring of the width between the alignment pins in the stopped position, maintenance, check and replacement of the pin shall be conducted periodically.

◆Selection of Adhesives

Some adhesives may cause IR deterioration. The different shrinkage percentage of between the adhesive and the capacitors may result in stresses on the capacitors and lead to cracking. Moreover, too little or too much adhesive applied to the board may adversely affect components. Therefore, the following precautions shall be noted in the application of adhesives.

- (1) Required adhesive characteristics
  - a. The adhesive shall be strong enough to hold parts on the board during the mounting & solder process.
  - b. The adhesive shall have sufficient strength at high temperatures.
  - c. The adhesive shall have good coating and thickness consistency.
  - d. The adhesive shall be used during its prescribed shelf life.
  - e. The adhesive shall harden rapidly.
  - f. The adhesive shall have corrosion resistance.
  - g. The adhesive shall have excellent insulation characteristics.
  - h. The adhesive shall have no emission of toxic gasses and no effect on the human body.
- (2) The recommended amount of adhesives is as follows;

[Recommended condition]

Figure	212/316 case sizes as examples
a	0.3mm min
b	100 to 120 μm
c	Adhesives shall not contact land



4. Soldering

◆Selection of Flux

- Since flux may have a significant effect on the performance of capacitors, it is necessary to verify the following conditions prior to use;
- (1) Flux used shall be less than or equal to 0.1 wt% ( in Cl equivalent) of halogenated content. Flux having a strong acidity content shall not be applied.
  - (2) When shall capacitors are soldered on boards, the amount of flux applied shall be controlled at the optimum level.
  - (3) When water-soluble flux is used, special care shall be taken to properly clean the boards.

Precautions

◆Soldering

Temperature, time, amount of solder, etc. shall be set in accordance with their recommended conditions.  
Sn-Zn solder paste can adversely affect MLOC reliability.  
Please contact us prior to usage of Sn-Zn solder.

Technical considerations

◆Selection of Flux

- 1-1. When too much halogenated substance (Chlorine, etc.) content is used to activate flux, or highly acidic flux is used, it may lead to corrosion of terminal electrodes or degradation of insulation resistance on the surfaces of the capacitors.
- 1-2. Flux is used to increase solderability in wave soldering. However if too much flux is applied, a large amount of flux gas may be emitted and may adversely affect the solderability. To minimize the amount of flux applied, it is recommended to use a flux-bubbling system.
- 1-3. Since the residue of water-soluble flux is easily dissolved in moisture in the air, the residues on the surfaces of capacitors in high humidity conditions may cause a degradation of insulation resistance and reliability of the capacitors. Therefore, the cleaning methods and the capability of the machines used shall also be considered carefully when water-soluble flux is used.

▶ This catalog contains the typical specification only due to the limitation of space. When you consider the purchase of our products, please check our specification. For details of each product (characteristics graph, reliability information, precautions for use, and so on), see our Web site (<http://www.ty-top.com/>).

◆ Soldering

- Ceramic chip capacitors are susceptible to thermal shock when exposed to rapid or concentrated heating or rapid cooling.
- Therefore, the soldering must be conducted with great care so as to prevent malfunction of the components due to excessive thermal shock.
- Preheating : Capacitors shall be preheated sufficiently, and the temperature difference between the capacitors and solder shall be within 130°C.
- Cooling : The temperature difference between the capacitors and cleaning process shall not be greater than 100°C.

[Reflow soldering]

【Recommended conditions for eutectic soldering】



【Recommended condition for Pb-free soldering】



Caution

- ① The ideal condition is to have solder mass (fillet) controlled to 1/2 to 1/3 of the thickness of a capacitor.
- ② Because excessive dwell times can adversely affect solderability, soldering duration shall be kept as close to recommended times as possible. soldering for 2 times.



[Wave soldering]

【Recommended conditions for eutectic soldering】



【Recommended condition for Pb-free soldering】



Caution

- ① Wave soldering must not be applied to capacitors designated as for reflow soldering only. soldering for 1 times.

[Hand soldering]

【Recommended conditions for eutectic soldering】



【Recommended condition for Pb-free soldering】



316type or less	$\Delta T \leq 150^{\circ}\text{C}$
-----------------	-------------------------------------



325type or more	$\Delta T \leq 130^{\circ}\text{C}$
-----------------	-------------------------------------

Caution

- ① Use a 50W soldering iron with a maximum tip diameter of 1.0 mm.
- ② The soldering iron shall not directly touch capacitors. soldering for 1 times.

5. Cleaning	
Precautions	<p>◆Cleaning conditions</p> <ol style="list-style-type: none"> <li>When PCBs are cleaned after capacitors mounting, please select the appropriate cleaning solution in accordance with the intended use of the cleaning. (e.g. to remove soldering flux or other materials from the production process.)</li> <li>Cleaning condition shall be determined after it is verified by using actual cleaning machine that the cleaning process does not affect capacitor's characteristics.</li> </ol>
Technical considerations	<ol style="list-style-type: none"> <li>The use of inappropriate cleaning solutions can cause foreign substances such as flux residue to adhere to capacitors or deteriorate their outer coating, resulting in a degradation of the capacitor's electrical properties (especially insulation resistance).</li> <li>Inappropriate cleaning conditions (insufficient or excessive cleaning) may adversely affect the performance of the capacitors. In the case of ultrasonic cleaning, too much power output can cause excessive vibration of PCBs which may lead to the cracking of capacitors or the soldered portion, or decrease the terminal electrodes' strength. Therefore, the following conditions shall be carefully checked;            Ultrasonic output : 20 W/l or less                      Ultrasonic frequency : 40 kHz or less            Ultrasonic washing period : 5 min. or less</li> </ol>

6. Resin coating and mold	
Precautions	<ol style="list-style-type: none"> <li>With some type of resins, decomposition gas or chemical reaction vapor may remain inside the resin during the hardening period or while left under normal storage conditions resulting in the deterioration of the capacitor's performance.</li> <li>When a resin's hardening temperature is higher than capacitor's operating temperature, the stresses generated by the excessive heat may lead to damage or destruction of capacitors. The use of such resins, molding materials etc. is not recommended.</li> </ol>

7. Handling	
Precautions	<p>◆Splitting of PCB</p> <ol style="list-style-type: none"> <li>When PCBs are split after components mounting, care shall be taken so as not to give any stresses of deflection or twisting to the board.</li> <li>Board separation shall not be done manually, but by using the appropriate devices.</li> </ol> <p>◆Mechanical considerations</p> <p>Be careful not to subject capacitors to excessive mechanical shocks.</p> <p>(1) If ceramic capacitors are dropped onto a floor or a hard surface, they shall not be used.</p> <p>(2) Please be careful that the mounted components do not come in contact with or bump against other boards or components.</p>

8. Storage conditions	
Precautions	<p>◆Storage</p> <ol style="list-style-type: none"> <li>To maintain the solderability of terminal electrodes and to keep packaging materials in good condition, care must be taken to control temperature and humidity in the storage area. Humidity should especially be kept as low as possible.           <ul style="list-style-type: none"> <li>Recommended conditions                Ambient temperature : Below 30°C                      Humidity : Below 70% RH</li> <li>The ambient temperature must be kept below 40°C. Even under ideal storage conditions, solderability of capacitor is deteriorated as time passes, so capacitors shall be used within 6 months from the time of delivery.</li> <li>Ceramic chip capacitors shall be kept where no chlorine or sulfur exists in the air.</li> </ul> </li> <li>The capacitance values of high dielectric constant capacitors will gradually decrease with the passage of time, so care shall be taken to design circuits. Even if capacitance value decreases as time passes, it will get back to the initial value by a heat treatment at 150°C for 1 hour.</li> </ol>
Technical considerations	<p>If capacitors are stored in a high temperature and humidity environment, it might rapidly cause poor solderability due to terminal oxidation and quality loss of taping/packaging materials. For this reason, capacitors shall be used within 6 months from the time of delivery. If exceeding the above period, please check solderability before using the capacitors.</p>

※RCR-2335B (Safety Application Guide for fixed ceramic capacitors for use in electronic equipment) is published by JEITA.

Please check the guide regarding precautions for deflection test, soldering by spot heat, and so on.

## X-ON Electronics

Largest Supplier of Electrical and Electronic Components

*Click to view similar products for [Multilayer Ceramic Capacitors MLCC - SMD/SMT category](#):*

*Click to view products by [Taiyo Yuden manufacturer](#):*

Other Similar products are found below :

[M39014/02-1225V](#) [M39014/22-0631](#) [D55342E07B523DR-T/R](#) [NCA1206X7R103K50TRPF](#) [NCA1206X7R104K16TRPF](#) [NIN-FB391JTRF](#)  
[NIN-FC2R7JTRF](#) [NMC0201X5R474K4TRPF](#) [NMC0402NPO220J50TRPF](#) [NMC0402X5R105K6.3TRPF](#) [NMC0402X5R224K6.3TRPF](#)  
[NMC0402X7R103J25TRPF](#) [NMC0402X7R153K16TRPF](#) [NMC0603NPO1R8C50TRPF](#) [NMC0603NPO201J50TRPF](#)  
[NMC0603NPO330G50TRPF](#) [NMC0603X5R475M6.3TRPF](#) [NMC0805NPO270J50TRPF](#) [NMC0805NPO820J50TRPF](#)  
[NMC0805X7R224K16TRPLPF](#) [NMC0805X7R224K25TRPF](#) [NMC1206X7R102K50TRPF](#) [NMC1206X7R106K10TRPLPF](#)  
[NMC1206X7R475K10TRPLPF](#) [NMC-H0805X7R472K250TRPF](#) [NMC-L0402NPO7R0C50TRPF](#) [NMC-L0603NPO2R2B50TRPF](#) [NMC-](#)  
[Q0402NPO8R2D200TRPF](#) [C1206C101J1GAC](#) [C1608C0G2A221J](#) [C1608X7R1E334K](#) [C2012C0G2A472J](#) [2220J2K00562KXT](#)  
[1812J2K00332KXT](#) [CDR31BX103AKWR](#) [CDR33BX104AKUR](#) [CDR33BX683AKUS](#) [CGA2B2C0G1H010C](#) [CGA2B2C0G1H040C](#)  
[CGA2B2C0G1H050C](#) [CGA2B2C0G1H060D](#) [CGA2B2C0G1H070D](#) [CGA2B2C0G1H120J](#) [CGA2B2C0G1H151J](#)  
[CGA2B2C0G1H181JT0Y0F](#) [CGA2B2C0G1H1R5C](#) [CGA2B2C0G1H2R2C](#) [CGA2B2C0G1H390J](#) [CGA2B2C0G1H391J](#)  
[CGA2B2C0G1H3R3C](#)