

# Notice for TAIYO YUDEN Products

---

Please read this notice before using the TAIYO YUDEN products.



## REMINDERS

### ■ Product Information in this Catalog

Product information in this catalog is as of October 2021. All of the contents specified herein and production status of the products listed in this catalog are subject to change without notice due to technical improvement of our products, etc. Therefore, please check for the latest information carefully before practical application or use of our products.

Please note that TAIYO YUDEN shall not be in any way responsible for any damages and defects in products or equipment incorporating our products, which are caused under the conditions other than those specified in this catalog or individual product specification sheets.

### ■ Approval of Product Specifications

Please contact TAIYO YUDEN for further details of product specifications as the individual product specification sheets are available. When using our products, please be sure to approve our product specifications or make a written agreement on the product specification with TAIYO YUDEN in advance.

### ■ Pre-Evaluation in the Actual Equipment and Conditions

Please conduct validation and verification of our products in actual conditions of mounting and operating environment before using our products.

### ■ Safety Design

When using our products for high safety and/or reliability-required equipment or circuits, please fully perform safety and/or reliability evaluation. In addition, please install (i) systems equipped with a protection circuit and a protection device and/or (ii) systems equipped with a redundant circuit or other system to prevent an unsafe status in the event of a single fault for a failsafe design to ensure safety.

### ■ Intellectual Property Rights

Information contained in this catalog is intended to convey examples of typical performances and/or applications of our products and is not intended to make any warranty with respect to the intellectual property rights or any other related rights of TAIYO YUDEN or any third parties nor grant any license under such rights.

### ■ Limited Warranty

Please note that the scope of warranty for our products is limited to the delivered our products themselves conforming to the product specifications specified in the individual product specification sheets, and TAIYO YUDEN shall not be in any way responsible for any damages resulting from a failure or defect in our products. Notwithstanding the foregoing, if there is a written agreement (e.g., supply and purchase agreement, quality assurance agreement) signed by TAIYO YUDEN and your company, TAIYO YUDEN will warrant our products in accordance with such agreement, provided, however, that our products shall be used for general-purpose and standard use in the equipment specified in this catalog or the individual product specification sheets.

### ■ TAIYO YUDEN's Official Sales Channel

The contents of this catalog are applicable to our products which are purchased from our sales offices or authorized distributors (hereinafter "TAIYO YUDEN's official sales channel"). Please note that the contents of this catalog are not applicable to our products purchased from any seller other than TAIYO YUDEN's official sales channel.

### ■ Caution for Export

Some of our products listed in this catalog may require specific procedures for export according to "U.S. Export Administration Regulations", "Foreign Exchange and Foreign Trade Control Law" of Japan, and other applicable regulations. Should you have any questions on this matter, please contact our sales staff.

## Limited Application

### 1. Equipment Intended for Use

The products listed in this catalog are intended for general-purpose and standard use in general electronic equipment for consumer (e.g., AV equipment, OA equipment, home electric appliances, office equipment, information and communication equipment including, without limitation, mobile phone, and PC) and other equipment specified in this catalog or the individual product specification sheets, or the equipment approved separately by TAIYO YUDEN.

TAIYO YUDEN has the product series intended for use in the following equipment. Therefore, when using our products for these equipment, please check available applications specified in this catalog or the individual product specification sheets and use the corresponding products.

Application	Product Series		Quality Grade <sup>*3</sup>
	Equipment <sup>*1</sup>	Category (Part Number Code <sup>*2</sup> )	
Automotive	Automotive Electronic Equipment (POWERTRAIN, SAFETY)	A	1
	Automotive Electronic Equipment (BODY & CHASSIS, INFOTAINMENT)	C	2
Industrial	Telecommunications Infrastructure and Industrial Equipment	B	2
Medical	Medical Devices classified as GHTF Class C (Japan Class III)	M	2
	Medical Devices classified as GHTF Classes A or B (Japan Classes I or II)	L	3
Consumer	General Electronic Equipment	S	3

\*Notes: 1. Based on the general specifications required for electronic components for such equipment, which are recognized by TAIYO YUDEN, the use of each product series for the equipment is recommended. Please be sure to contact TAIYO YUDEN before using our products for equipment other than those covered by the product series.

2. On each of our part number, the 2nd code from the left is a code indicating the "Category" as shown in the above table. For details, please check the explanatory materials regarding the part numbering system of each of our products.

3. Each product series is assigned a "Quality Grade" from 1 to 3 in order of higher quality. Please do not incorporate a product into any equipment with a higher Quality Grade than the Quality Grade of such product without the prior written consent of TAIYO YUDEN.

### 2. Equipment Requiring Inquiry

Please be sure to contact TAIYO YUDEN for further information before using the products listed in this catalog for the following equipment (excluding intended equipment as specified in this catalog or the individual product specification sheets) which may cause loss of human life, bodily injury, serious property damage and/or serious public impact due to a failure or defect of the products and/or malfunction attributed thereto.

- (1) Transportation equipment (automotive powertrain control system, train control system, and ship control system, etc.)
- (2) Traffic signal equipment
- (3) Disaster prevention equipment, crime prevention equipment
- (4) Medical devices classified as GHTF Class C (Japan Class III)
- (5) Highly public information network equipment, data-processing equipment (telephone exchange, and base station, etc.)
- (6) Any other equipment requiring high levels of quality and/or reliability equal to the equipment listed above

### 3. Equipment Prohibited for Use

Please do not incorporate our products into the following equipment requiring extremely high levels of safety and/or reliability.

- (1) Aerospace equipment (artificial satellite, rocket, etc.)
- (2) Aviation equipment <sup>\*1</sup>
- (3) Medical devices classified as GHTF Class D (Japan Class IV), implantable medical devices <sup>\*2</sup>
- (4) Power generation control equipment (nuclear power, hydroelectric power, thermal power plant control system, etc.)
- (5) Undersea equipment (submarine repeating equipment, etc.)
- (6) Military equipment
- (7) Any other equipment requiring extremely high levels of safety and/or reliability equal to the equipment listed above

\*Notes: 1. There is a possibility that our products can be used only for aviation equipment that does not directly affect the safe operation of aircraft (e.g., in-flight entertainment, cabin light, electric seat, cooking equipment) if such use meets requirements specified separately by TAIYO YUDEN. Please be sure to contact TAIYO YUDEN for further information before using our products for such aviation equipment.

2. Implantable medical devices contain not only internal unit which is implanted in a body, but also external unit which is connected to the internal unit.

### 4. Limitation of Liability

Please note that unless you obtain prior written consent of TAIYO YUDEN, TAIYO YUDEN shall not be in any way responsible for any damages incurred by you or third parties arising from use of the products listed in this catalog for any equipment that is not intended for use by TAIYO YUDEN, or any equipment requiring inquiry to TAIYO YUDEN or prohibited for use by TAIYO YUDEN as described above.

# Automotive Application Guide

We classify automotive electronic equipment into the following four application categories and set usable application categories for each of our products. Therefore, we have the corresponding product series (the part number code of 2nd digit from the left side is "A" or "C"). When using our products for automotive electronic equipment, please be sure to check such application categories and use the corresponding product series accordingly. Should you have any questions on this matter, please contact us.

Product Series (Part Number Code of 2nd digit from the Left Side)	Category	Automotive Electronic Equipment (Typical Example)
A	POWERTRAIN	<ul style="list-style-type: none"> <li>• Engine ECU (Electronically Controlled Fuel Injector)</li> <li>• Cruise Control Unit</li> <li>• 4WS (4 Wheel Steering)</li> <li>• Transmission</li> <li>• Power Steering</li> <li>• HEV/PHV/EV Core Control (Battery, Inverter, DC-DC)</li> <li>• Automotive Locator (Car location information providing device), etc.</li> </ul>
	SAFETY	<ul style="list-style-type: none"> <li>• ABS (Anti-Lock Brake System)</li> <li>• ESC (Electronic Stability Control)</li> <li>• Airbag</li> <li>• ADAS (Equipment that directly controls running, turning and stopping), etc.</li> </ul>
C	BODY & CHASSIS	<ul style="list-style-type: none"> <li>• Wiper</li> <li>• Automatic Door</li> <li>• Power Window</li> <li>• Keyless Entry System</li> <li>• Electric Door Mirror</li> <li>• Automobile Digital Mirror</li> <li>• Interior Lighting</li> <li>• Automobile Air Conditioning System</li> <li>• TPMS (Tire Pressure Monitoring System)</li> <li>• Anti-Theft Device (Immobilizer), etc.</li> </ul>
	INFOTAINMENT	<ul style="list-style-type: none"> <li>• Car Infotainment System</li> <li>• ITS/Telematics System</li> <li>• Instrument Cluster</li> <li>• ADAS (Sensor, Equipment that is not interlocked with safety equipment or powertrain)</li> <li>• Dashcam (genuine products for automotive manufacturer), etc.</li> </ul>

# Wire-wound Ferrite Power Inductors LCXN/LCXP series for Automotive Body & Chassis and Infotainment

Code in front of Series have been extracted from Part number, which describes the segment of products, such as kinds and characteristics.

AEC-Q200 Grade 3 (we conduct the evaluation at the test condition of Grade 3.)

\*Operating environment Temp:-40~85°C

REFLOW

AEC-Q200

## PART NUMBER

\*Operating Temp. : -40~125°C(Including self-generated heat)

L	C	X	N	D	4	0	4	0	T	K	L	1	0	0	M	D	G
①	②	③	④	⑤	⑥	⑦	⑧										

## ①Series

Code (1)(2)(3)(4)	
LCXN	Wire-wound Ferrite Power Inductor for Automotive Body & Chassis and Infotainment
LCXP	Wire-wound Ferrite Power Inductor for Automotive Body & Chassis and Infotainment

## (1) Product Group

Code	
L	Inductors

## (3) Type

Code	
X	Ferrite Wire-wound (Drum type)

## (2) Category

Code	Recommended equipment	Quality Grade
C	Automotive Electronic Equipment (Body & Chassis, Infotainment)	2

## (4) Features, Characteristics

Code	
N	Standard Power choke
P	High current power choke

## ②Features

Code	Feature
D	Bottom electrode (Ag × solder)
E	Bottom electrode (Cu × solder)
H	Bottom electrode (Frame type)

## ⑤Packaging

Code	Packaging
T	Taping
L	Taping

## ③Dimensions (L × W)

Code	Dimensions (L × W) [mm]
2020	2.0 × 2.0
2424	2.4 × 2.4
3030	3.0 × 3.0
4040	4.0 × 4.0
5050	5.0 × 5.0
6060	6.0 × 6.0
8080	8.0 × 8.0

## ⑥Nominal inductance

Code (example)	Nominal inductance [μH]
2R2	2.2
100	10
101	100

※R=Decimal point

## ④Dimensions (H)

Code	Dimensions (H) [mm]
KK	1.0
MK	1.2
PK	1.4
QK	1.5
TK	1.8
WK	2.0
WD	2.4
WE	2.5
WH	2.8
XK	3.0
XA	3.1
YK	4.0
YA	4.1
YB	4.2
YE	4.5

## ⑦Inductance tolerance

Code	Inductance tolerance
M	±20%
N	±30%

## ⑧Internal code

## STANDARD EXTERNAL DIMENSIONS / STANDARD QUANTITY

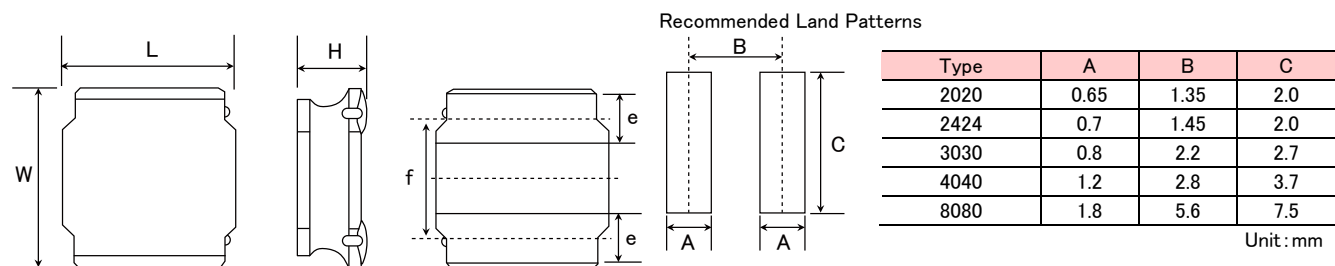

Type	L	W	H	e	f	Standard quantity [pcs] Taping
2020KK	2.0±0.1 (0.079±0.004)	2.0±0.1 (0.079±0.004)	1.0 max (0.039 max)	0.5±0.2 (0.020±0.008)	1.25±0.2 (0.050±0.008)	2500
2020MK	2.0±0.1 (0.079±0.004)	2.0±0.1 (0.079±0.004)	1.2 max (0.047 max)	0.5±0.2 (0.020±0.008)	1.25±0.2 (0.050±0.008)	2500
2424KK	2.4±0.1 (0.095±0.004)	2.4±0.1 (0.095±0.004)	1.0 max (0.039 max)	0.6±0.2 (0.024±0.008)	1.45±0.2 (0.057±0.008)	2500
2424MK	2.4±0.1 (0.095±0.004)	2.4±0.1 (0.095±0.004)	1.2 max (0.047 max)	0.6±0.2 (0.024±0.008)	1.45±0.2 (0.057±0.008)	2500
3030KK	3.0±0.1 (0.118±0.004)	3.0±0.1 (0.118±0.004)	1.0 max (0.039 max)	0.9±0.2 (0.035±0.008)	1.9±0.2 (0.075±0.008)	2000
3030MK	3.0±0.1 (0.118±0.004)	3.0±0.1 (0.118±0.004)	1.2 max (0.047 max)	0.9±0.2 (0.035±0.008)	1.9±0.2 (0.075±0.008)	2000
3030QK	3.0±0.1 (0.118±0.004)	3.0±0.1 (0.118±0.004)	1.5 max (0.059 max)	0.9±0.2 (0.035±0.008)	1.9±0.2 (0.075±0.008)	2000
4040KK	4.0±0.2 (0.158±0.008)	4.0±0.2 (0.158±0.008)	1.0 max (0.039 max)	1.1±0.2 (0.043±0.008)	2.5±0.2 (0.098±0.008)	5000
4040MK	4.0±0.2 (0.158±0.008)	4.0±0.2 (0.158±0.008)	1.2 max (0.047 max)	1.1±0.2 (0.043±0.008)	2.5±0.2 (0.098±0.008)	4500
4040TK	4.0±0.2 (0.158±0.008)	4.0±0.2 (0.158±0.008)	1.8 max (0.071 max)	1.1±0.2 (0.043±0.008)	2.5±0.2 (0.098±0.008)	3500
8080XK	8.0±0.2 (0.315±0.008)	8.0±0.2 (0.315±0.008)	3.0 max (0.118 max)	1.60±0.3 (0.063±0.012)	5.6±0.3 (0.22±0.012)	1000
8080YK	8.0±0.2 (0.315±0.008)	8.0±0.2 (0.315±0.008)	4.0 max (0.158 max)	1.60±0.3 (0.063±0.012)	5.6±0.3 (0.22±0.012)	1000
8040YB	8.0±0.2 (0.315±0.008)	8.0±0.2 (0.315±0.008)	4.2 max (0.165 max)	1.60±0.3 (0.063±0.012)	5.6±0.3 (0.22±0.012)	1000

Unit: mm (inch)

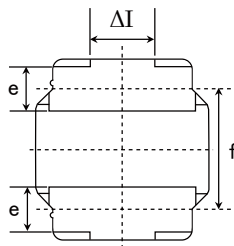
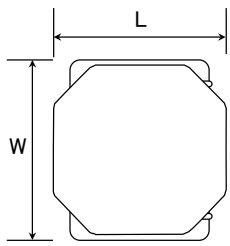

Recommended Land Patterns

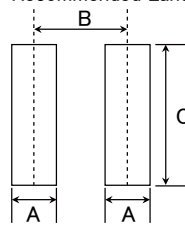

Type	A	B	C
5050	1.5	3.6	4.0
6060	1.6	4.7	5.7

Unit: mm

Type	L	W	H	e	f	ΔI	Standard quantity [pcs] Taping
5050KK	4.9±0.2 (0.193±0.008)	4.9±0.2 (0.193±0.008)	1.0 max (0.039 max)	1.2±0.2 (0.047±0.008)	3.3±0.2 (0.130±0.008)	1.3typ (0.051typ)	1000
5050MK	4.9±0.2 (0.193±0.008)	4.9±0.2 (0.193±0.008)	1.2 max (0.047 max)	1.2±0.2 (0.047±0.008)	3.3±0.2 (0.130±0.008)	1.3typ (0.051typ)	1000
5050PK	4.9±0.2 (0.193±0.008)	4.9±0.2 (0.193±0.008)	1.4 max (0.055 max)	1.2±0.2 (0.047±0.008)	3.3±0.2 (0.130±0.008)	1.3typ (0.051typ)	1000
5050WK	4.9±0.2 (0.193±0.008)	4.9±0.2 (0.193±0.008)	2.0 max (0.079 max)	1.2±0.2 (0.047±0.008)	3.3±0.2 (0.130±0.008)	1.3typ (0.051typ)	800
5050WD	4.9±0.2 (0.193±0.008)	4.9±0.2 (0.193±0.008)	2.4max (0.095 max)	1.2±0.2 (0.047±0.008)	3.3±0.2 (0.130±0.008)	1.3typ (0.051typ)	2500
5050WE	4.9±0.2 (0.193±0.008)	4.9±0.2 (0.193±0.008)	2.5 max (0.098 max)	1.2±0.2 (0.047±0.008)	3.3±0.2 (0.130±0.008)	1.3typ (0.051typ)	2500
5050XK	4.9±0.2 (0.193±0.008)	4.9±0.2 (0.193±0.008)	3.0 max (0.118 max)	1.2±0.2 (0.047±0.008)	3.3±0.2 (0.130±0.008)	1.3typ (0.051typ)	500
5050XA	4.9±0.2 (0.193±0.008)	4.9±0.2 (0.193±0.008)	3.1 max (0.122 max)	1.2±0.2 (0.047±0.008)	3.3±0.2 (0.130±0.008)	1.3typ (0.051typ)	500
5050YK	4.9±0.2 (0.193±0.008)	4.9±0.2 (0.193±0.008)	4.0 max (0.158 max)	1.2±0.2 (0.047±0.008)	3.3±0.2 (0.130±0.008)	1.3typ (0.051typ)	1500
5050YA	4.9±0.2 (0.193±0.008)	4.9±0.2 (0.193±0.008)	4.1 max (0.161 max)	1.2±0.2 (0.047±0.008)	3.3±0.2 (0.130±0.008)	1.3typ (0.051typ)	1500
6060KK	6.0±0.2 (0.236±0.008)	6.0±0.2 (0.236±0.008)	1.0 max (0.039 max)	1.35±0.2 (0.053±0.008)	4.0±0.2 (0.158±0.008)	2.3typ (0.091typ)	1000
6060MK	6.0±0.2 (0.236±0.008)	6.0±0.2 (0.236±0.008)	1.2 max (0.047 max)	1.35±0.2 (0.053±0.008)	4.0±0.2 (0.158±0.008)	2.3typ (0.091typ)	1000
6060PK	6.0±0.2 (0.236±0.008)	6.0±0.2 (0.236±0.008)	1.4 max (0.055 max)	1.35±0.2 (0.053±0.008)	4.0±0.2 (0.158±0.008)	2.3typ (0.091typ)	1000
6060WK	6.0±0.2 (0.236±0.008)	6.0±0.2 (0.236±0.008)	2.0 max (0.079 max)	1.35±0.2 (0.053±0.008)	4.0±0.2 (0.158±0.008)	2.3typ (0.091typ)	2500
6060WH	6.0±0.2 (0.236±0.008)	6.0±0.2 (0.236±0.008)	2.8 max (0.110 max)	1.35±0.2 (0.053±0.008)	4.0±0.2 (0.158±0.008)	2.3typ (0.091typ)	2000
6060YE	6.0±0.2 (0.236±0.008)	6.0±0.2 (0.236±0.008)	4.5 max (0.177 max)	1.35±0.2 (0.053±0.008)	4.0±0.2 (0.158±0.008)	2.3typ (0.091typ)	1500

Unit: mm (inch)

## PART NUMBER

• All the Wire-wound Ferrite Power Inductors of the catalog lineup are RoHS compliant.

## Notes)

- The exchange of individual specifications is necessary depending on your application and/or circuit condition. Please contact TAIYO YUDEN's official sales channel.
- For Automotive (AEC-Q200 Qualified) products for BODY & CHASSIS, and INFOTAINMENT. Please check "Automotive Application Guide" for further details before using the products.

< AEC-Q200 : AEC-Q200 qualified >

All the Wire-wound Ferrite Power Inductors for Automotive products are tested based on the test conditions and methods defined in AEC-Q200 by family item.

Please consult with TAIYO YUDEN's official sales channel for the details of the product specifications and AEC-Q200 test results, etc., and please review and approve the product specifications before ordering.

## 2020KK type

New part number	Old part number (for reference)	Nominal inductance [ $\mu$ H]	Inductance tolerance	Self-resonant frequency [MHz] (min.)	DC Resistance [ $\Omega$ ] ( $\pm 20\%$ )	Rated current ※) [mA]		Measuring frequency [kHz]
						Saturation current Idc1	Temperature rise current Idc2	
LCXPD2020KKT4R7N0G	NRV2010T R47N GFV	0.47	$\pm 30\%$	-	0.052	2,100	2,000	100
LCXPD2020KKT R68N0G	NRV2010T R68N GFV	0.68	$\pm 30\%$	-	0.060	1,850	1,850	100
LCXPD2020KKT1R0N0G	NRV2010T 1R0N GFV	1.0	$\pm 30\%$	-	0.080	1,550	1,600	100
LCXPD2020KKT1R5M0G	NRV2010T 1R5M GFV	1.5	$\pm 20\%$	-	0.100	1,350	1,450	100
LCXPD2020KKT2R2M0G	NRV2010T 2R2M GFV	2.2	$\pm 20\%$	-	0.175	1,100	1,100	100
LCXPD2020KKT3R3M0G	NRV2010T 3R3M GFV	3.3	$\pm 20\%$	-	0.250	880	1,000	100
LCXPD2020KKT4R7M0G	NRV2010T 4R7M GFV	4.7	$\pm 20\%$	-	0.320	760	820	100

## 2020MK type

New part number	Old part number (for reference)	Nominal inductance [ $\mu$ H]	Inductance tolerance	Self-resonant frequency [MHz] (min.)	DC Resistance [ $\Omega$ ] ( $\pm 20\%$ )	Rated current ※) [mA]		Measuring frequency [kHz]
						Saturation current Idc1	Temperature rise current Idc2	
LCXPD2020MKT1R0N0G	NRV2012T 1R0N GFV	1.0	$\pm 30\%$	-	0.073	2,200	1,650	100
LCXPD2020MKT1R5N0G	NRV2012T 1R5N GFV	1.5	$\pm 30\%$	-	0.100	1,800	1,400	100
LCXPD2020MKT2R2M0G	NRV2012T 2R2M GFV	2.2	$\pm 20\%$	-	0.129	1,600	1,200	100
LCXPD2020MKT3R3M0G	NRV2012T 3R3M GFV	3.3	$\pm 20\%$	-	0.227	1,250	900	100
LCXPD2020MKT4R7M0G	NRV2012T 4R7M GFV	4.7	$\pm 20\%$	-	0.325	1,100	750	100

## 2020MK type

New part number	Old part number (for reference)	Nominal inductance [ $\mu$ H]	Inductance tolerance	Self-resonant frequency [MHz] (min.)	DC Resistance [ $\Omega$ ] ( $\pm 20\%$ )	Rated current ※) [mA]		Measuring frequency [kHz]
						Saturation current Idc1	Temperature rise current Idc2	
LCXND2020MKT1R0N0G	NRS2012T 1R0N GJV	1.0	$\pm 30\%$	-	0.070	1,900	1,700	100
LCXND2020MKT1R5N0G	NRS2012T 1R5N GJV	1.5	$\pm 30\%$	-	0.090	1,650	1,500	100
LCXND2020MKT2R2M0G	NRS2012T 2R2M GJV	2.2	$\pm 20\%$	-	0.107	1,350	1,370	100
LCXND2020MKT3R3M0G	NRS2012T 3R3M GJV	3.3	$\pm 20\%$	-	0.190	1,000	1,020	100
LCXND2020MKT4R7M0G	NRS2012T 4R7M GJV	4.7	$\pm 20\%$	-	0.241	900	910	100

## 2424KK type

New part number	Old part number (for reference)	Nominal inductance [ $\mu$ H]	Inductance tolerance	Self-resonant frequency [MHz] (min.)	DC Resistance [ $\Omega$ ] ( $\pm 20\%$ )	Rated current ※) [mA]		Measuring frequency [kHz]
						Saturation current Idc1	Temperature rise current Idc2	
LCXNE2424KKT R68NN	NRH2410T R68NN 4V	0.68	$\pm 30\%$	120	0.060	2,200	1,570	100
LCXNE2424KKT1R0NN	NRH2410T 1R0NN 4V	1.0	$\pm 30\%$	106	0.070	1,800	1,410	100
LCXNE2424KKT1R5MN	NRH2410T 1R5MN V	1.5	$\pm 20\%$	94	0.110	1,550	1,160	100
LCXNE2424KKT2R2MN	NRH2410T 2R2MN V	2.2	$\pm 20\%$	77	0.150	1,290	970	100
LCXNE2424KKT3R3MN	NRH2410T 3R3MN V	3.3	$\pm 20\%$	56	0.220	1,000	770	100
LCXNE2424KKT4R7MN	NRH2410T 4R7MN V	4.7	$\pm 20\%$	50	0.290	880	670	100
LCXNE2424KKT6R8MN	NRH2410T 6R8MN V	6.8	$\pm 20\%$	43	0.410	750	570	100
LCXNE2424KKT100MN	NRH2410T 100MN V	10	$\pm 20\%$	32	0.690	550	450	100
LCXNE2424KKT150MN	NRH2410T 150MN V	15	$\pm 20\%$	27	1.02	470	370	100
LCXNE2424KKT220MN	NRH2410T 220MN V	22	$\pm 20\%$	22	1.47	390	300	100

## 2424MK type

New part number	Old part number (for reference)	Nominal inductance [ $\mu$ H]	Inductance tolerance	Self-resonant frequency [MHz] (min.)	DC Resistance [ $\Omega$ ] ( $\pm 20\%$ )	Rated current ※) [mA]		Measuring frequency [kHz]
						Saturation current Idc1	Temperature rise current Idc2	
LCXNE2424MKT R47NNG	NRH2412T R47NNGJV	0.47	$\pm 30\%$	180	0.050	2,900	2,100	100
LCXNE2424MKT1R0NNG	NRH2412T 1R0NNGHV	1.0	$\pm 30\%$	101	0.077	2,350	1,300	100
LCXNE2424MKT1R5NNG	NRH2412T 1R5NNGHV	1.5	$\pm 30\%$	89	0.100	2,100	1,150	100
LCXNE2424MKT2R2MNG	NRH2412T 2R2MNGHV	2.2	$\pm 20\%$	72	0.140	1,700	1,000	100
LCXNE2424MKT3R3MNG	NRH2412T 3R3MNGHV	3.3	$\pm 20\%$	56	0.225	1,400	750	100
LCXNE2424MKT4R7MNG	NRH2412T 4R7MNGHV	4.7	$\pm 20\%$	45	0.300	1,150	650	100
LCXNE2424MKT6R8MNG	NRH2412T 6R8MNGHV	6.8	$\pm 20\%$	34	0.420	950	550	100
LCXNE2424MKT100MNG	NRH2412T 100MNGHV	10	$\pm 20\%$	29	0.600	810	450	100

※) The saturation current value (Idc1) is the DC current value having inductance decrease down to 30%. (at 20°C)

※) The temperature rise current value (Idc2) is the DC current value having temperature increase up to 40°C. (at 20°C)

※) The rated current is the DC current value that satisfies both of current value saturation current value and temperature rise current value.

## PART NUMBER

## 3030KK type

New part number	Old part number (for reference)	Nominal inductance [ $\mu$ H]	Inductance tolerance	Self-resonant frequency [MHz] (min.)	DC Resistance [ $\Omega$ ] ( $\pm 20\%$ )	Rated current ※) [mA]		Measuring frequency [kHz]
						Saturation current Idc1	Temperature rise current Idc2	
LCXNE3030KKT1R2NN	NRH3010T 1R2NN V	1.2	$\pm 30\%$	120	0.065	1,700	1,480	100
LCXNE3030KKT1R5NN	NRH3010T 1R5NN V	1.5	$\pm 30\%$	99	0.075	1,440	1,370	100
LCXNE3030KKT2R2MN	NRH3010T 2R2MN V	2.2	$\pm 20\%$	86	0.083	1,300	1,300	100
LCXNE3030KKT3R3MN	NRH3010T 3R3MN V	3.3	$\pm 20\%$	64	0.130	1,000	1,030	100
LCXNE3030KKT4R7MN	NRH3010T 4R7MN V	4.7	$\pm 20\%$	50	0.170	850	900	100
LCXNE3030KKT6R8MN	NRH3010T 6R8MN V	6.8	$\pm 20\%$	44	0.250	700	745	100
LCXNE3030KKT100MN	NRH3010T 100MN V	10	$\pm 20\%$	34	0.350	600	620	100
LCXNE3030KKT150MN	NRH3010T 150MN V	15	$\pm 20\%$	25	0.550	450	480	100
LCXNE3030KKT220MN	NRH3010T 220MN V	22	$\pm 20\%$	22	0.770	380	410	100
LCXNE3030KKT470MN	NRH3010T 470MN V	47	$\pm 20\%$	17	2.05	250	285	100

## 3030MK type

New part number	Old part number (for reference)	Nominal inductance [ $\mu$ H]	Inductance tolerance	Self-resonant frequency [MHz] (min.)	DC Resistance [ $\Omega$ ] ( $\pm 20\%$ )	Rated current ※) [mA]		Measuring frequency [kHz]
						Saturation current Idc1	Temperature rise current Idc2	
LCXNE3030MKTR47NN	NRH3012T R47NN V	0.47	$\pm 30\%$	160	0.033	2,600	1,900	100
LCXNE3030MKT1R0NN	NRH3012T 1R0NN V	1.0	$\pm 30\%$	111	0.048	2,200	1,710	100
LCXNE3030MKT1R5NN	NRH3012T 1R5NN V	1.5	$\pm 30\%$	95	0.055	1,700	1,600	100
LCXNE3030MKT2R2MN	NRH3012T 2R2MN V	2.2	$\pm 20\%$	78	0.075	1,500	1,370	100
LCXNE3030MKT3R3MN	NRH3012T 3R3MN V	3.3	$\pm 20\%$	61	0.100	1,200	1,210	100
LCXNE3030MKT4R7MN	NRH3012T 4R7MN V	4.7	$\pm 20\%$	50	0.130	1,000	1,060	100
LCXNE3030MKT6R8MN	NRH3012T 6R8MN V	6.8	$\pm 20\%$	43	0.190	850	890	100
LCXNE3030MKT100MN	NRH3012T 100MN V	10	$\pm 20\%$	32	0.270	730	720	100
LCXNE3030MKT150MN	NRH3012T 150MN V	15	$\pm 20\%$	26	0.450	530	570	100
LCXNE3030MKT220MN	NRH3012T 220MN V	22	$\pm 20\%$	22	0.630	500	500	100

## 3030MK type

New part number	Old part number (for reference)	Nominal inductance [ $\mu$ H]	Inductance tolerance	Self-resonant frequency [MHz] (min.)	DC Resistance [ $\Omega$ ] ( $\pm 20\%$ )	Rated current ※) [mA]		Measuring frequency [kHz]
						Saturation current Idc1	Temperature rise current Idc2	
LCXPD3030MKT1R0N	NRV3012T 1R0N V	1.0	$\pm 30\%$	110	0.065	2,500	1,600	100
LCXPD3030MKT1R5N	NRV3012T 1R5N V	1.5	$\pm 30\%$	92	0.075	2,100	1,400	100
LCXPD3030MKT2R2M	NRV3012T 2R2M V	2.2	$\pm 20\%$	70	0.120	1,800	1,100	100
LCXPD3030MKT3R3M	NRV3012T 3R3M V	3.3	$\pm 20\%$	55	0.150	1,600	1,000	100
LCXPD3030MKT4R7M	NRV3012T 4R7M V	4.7	$\pm 20\%$	48	0.190	1,250	850	100
LCXPD3030MKT6R8M	NRV3012T 6R8M V	6.8	$\pm 20\%$	40	0.300	950	650	100
LCXPD3030MKT100M	NRV3012T 100M V	10	$\pm 20\%$	32	0.470	800	550	100

## 3030QK type

New part number	Old part number (for reference)	Nominal inductance [ $\mu$ H]	Inductance tolerance	Self-resonant frequency [MHz] (min.)	DC Resistance [ $\Omega$ ] ( $\pm 20\%$ )	Rated current ※) [mA]		Measuring frequency [kHz]
						Saturation current Idc1	Temperature rise current Idc2	
LCXND3030QKT1R0NNG	NRS3015T 1R0NNGHV	1.0	$\pm 30\%$	100	0.030	2,100	2,100	100
LCXND3030QKT1R5NNG	NRS3015T 1R5NNGHV	1.5	$\pm 30\%$	87	0.038	1,800	1,820	100
LCXND3030QKT2R2MNG	NRS3015T 2R2MNGHV	2.2	$\pm 20\%$	64	0.058	1,480	1,500	100
LCXND3030QKT3R3MNG	NRS3015T 3R3MNGHV	3.3	$\pm 20\%$	49	0.078	1,210	1,230	100
LCXND3030QKT4R7MNG	NRS3015T 4R7MNGHV	4.7	$\pm 20\%$	40	0.120	1,020	1,040	100
LCXND3030QKT6R8MNG	NRS3015T 6R8MNGHV	6.8	$\pm 20\%$	36	0.160	870	880	100
LCXND3030QKT100MNG	NRS3015T 100MNGHV	10	$\pm 20\%$	28	0.220	700	710	100
LCXND3030QKT220MNG	NRS3015T 220MNGHV	22	$\pm 20\%$	20	0.520	470	470	100
LCXND3030QKT330MNG	NRS3015T 330MNGHV	33	$\pm 20\%$	18	0.780	400	440	100

## 4040KK type

New part number	Old part number (for reference)	Nominal inductance [ $\mu$ H]	Inductance tolerance	Self-resonant frequency [MHz] (min.)	DC Resistance [ $\Omega$ ] ( $\pm 20\%$ )	Rated current ※) [mA]		Measuring frequency [kHz]
						Saturation current Idc1	Temperature rise current Idc2	
LCXND4040KKL1R0NDG	NRS4010T 1R0NDGGV	1.0	$\pm 30\%$	116	0.056	2,000	2,000	100
LCXND4040KKL2R2MDG	NRS4010T 2R2MDGGV	2.2	$\pm 20\%$	73	0.085	1,200	1,500	100
LCXND4040KKL3R3MDG	NRS4010T 3R3MDGGV	3.3	$\pm 20\%$	58	0.100	1,100	1,400	100
LCXND4040KKL4R7MDG	NRS4010T 4R7MDGGV	4.7	$\pm 20\%$	47	0.140	950	1,200	100
LCXND4040KKL6R8MDG	NRS4010T 6R8MDGGV	6.8	$\pm 20\%$	38	0.200	800	1,000	100
LCXND4040KKL100MDG	NRS4010T 100MDGGV	10	$\pm 20\%$	31	0.300	620	750	100
LCXND4040KKL150MDG	NRS4010T 150MDGGV	15	$\pm 20\%$	24	0.430	540	600	100
LCXND4040KKL220MDG	NRS4010T 220MDGGV	22	$\pm 20\%$	19	0.570	450	500	100

## 4040MK type

New part number	Old part number (for reference)	Nominal inductance [ $\mu$ H]	Inductance tolerance	Self-resonant frequency [MHz] (min.)	DC Resistance [ $\Omega$ ] ( $\pm 20\%$ )	Rated current ※) [mA]		Measuring frequency [kHz]
						Saturation current Idc1	Temperature rise current Idc2	
LCXND4040MKL1R0NDG	NRS4012T 1R0NDGGV	1.0	$\pm 30\%$	100	0.042	2,800	2,200	100
LCXND4040MKL2R2MDG	NRS4012T 2R2MDGJV	2.2	$\pm 20\%$	70	0.060	1,650	1,900	100
LCXND4040MKL3R3MDG	NRS4012T 3R3MDGJV	3.3	$\pm 20\%$	60	0.070	1,400	1,700	100
LCXND4040MKL4R7MDG	NRS4012T 4R7MDGJV	4.7	$\pm 20\%$	45	0.095	1,200	1,500	100
LCXND4040MKL6R8MDG	NRS4012T 6R8MDGJV	6.8	$\pm 20\%$	35	0.125	900	1,300	100
LCXND4040MKL100MDG	NRS4012T 100MDGJV	10	$\pm 20\%$	30	0.170	800	1,100	100
LCXND4040MKL150MDG	NRS4012T 150MDGJV	15	$\pm 20\%$	24	0.260	650	750	100
LCXND4040MKL220MDG	NRS4012T 220MDGJV	22	$\pm 20\%$	18	0.400	500	620	100

※) The saturation current value (Idc1) is the DC current value having inductance decrease down to 30%. (at 20°C)

※) The temperature rise current value (Idc2) is the DC current value having temperature increase up to 40°C. (at 20°C)

※) The rated current is the DC current value that satisfies both of current value saturation current value and temperature rise current value.



■ PART NUMBER

● 4040TK type

New part number	Old part number (for reference)	Nominal inductance [μH]	Inductance tolerance	Self-resonant frequency [MHz] (min.)	DC Resistance [Ω] (±20%)	Rated current ※) [mA]		Measuring frequency [kHz]
						Saturation current Idc1	Temperature rise current Idc2	
LCXND4040TKL1R0NDG	NRS4018T 1R0NDGJV	1.0	±30%	90	0.027	4,000	3,200	100
LCXND4040TKL1R5NDG	NRS4018T 1R5NDGJV	1.5	±30%	75	0.037	3,300	2,400	100
LCXND4040TKL2R2MDG	NRS4018T 2R2MDGJV	2.2	±20%	60	0.042	3,000	2,200	100
LCXND4040TKL3R3MDG	NRS4018T 3R3MDGJV	3.3	±20%	45	0.055	2,300	2,000	100
LCXND4040TKL4R7MDG	NRS4018T 4R7MDGJV	4.7	±20%	35	0.070	2,000	1,700	100
LCXND4040TKL6R8MDG	NRS4018T 6R8MDGJV	6.8	±20%	30	0.098	1,600	1,450	100
LCXND4040TKL100MDG	NRS4018T 100MDGJV	10	±20%	25	0.150	1,300	1,200	100
LCXND4040TKL150MDG	NRS4018T 150MDGJV	15	±20%	18	0.210	1,100	850	100
LCXND4040TKL220MDG	NRS4018T 220MDGJV	22	±20%	15	0.290	900	720	100
LCXND4040TKL330MDG	NRS4018T 330MDGJV	33	±20%	12	0.460	700	550	100
LCXND4040TKL470MDG	NRS4018T 470MDGJV	47	±20%	10	0.650	600	440	100
LCXND4040TKL680MDG	NRS4018T 680MDGJV	68	±20%	8.3	1.00	520	320	100
LCXND4040TKL101MDG	NRS4018T 101MDGJV	100	±20%	6.5	1.45	420	280	100
LCXND4040TKL151MDG	NRS4018T 151MDGJV	150	±20%	5.5	2.30	340	220	100
LCXND4040TKL221MDG	NRS4018T 221MDGJV	220	±20%	4.0	3.80	275	170	100

● 5050KK type

New part number	Old part number (for reference)	Nominal inductance [μH]	Inductance tolerance	Self-resonant frequency [MHz] (min.)	DC Resistance [Ω] (±20%)	Rated current ※) [mA]		Measuring frequency [kHz]
						Saturation current Idc1	Temperature rise current Idc2	
LCXND5050KKT1R0NMG	NRS5010T 1R0NMGFV	1.0	±30%	95	0.070	2,350	1,750	100
LCXND5050KKT2R2NMG	NRS5010T 2R2NMGFV	2.2	±30%	65	0.105	1,500	1,400	100
LCXND5050KKT3R3MMG	NRS5010T 3R3MMGFV	3.3	±20%	42	0.125	1,400	1,250	100
LCXND5050KKT4R7MMG	NRS5010T 4R7MMGFV	4.7	±20%	37	0.145	1,200	1,150	100
LCXND5050KKT6R8MMG	NRS5010T 6R8MMGFV	6.8	±20%	33	0.185	1,000	1,000	100
LCXND5050KKT100MMG	NRS5010T 100MMGFV	10	±20%	23	0.250	850	900	100
LCXND5050KKT150MMG	NRS5010T 150MMGFV	15	±20%	19	0.400	680	650	100
LCXND5050KKT220MMG	NRS5010T 220MMGFV	22	±20%	15	0.600	550	450	100

● 5050MK type

New part number	Old part number (for reference)	Nominal inductance [μH]	Inductance tolerance	Self-resonant frequency [MHz] (min.)	DC Resistance [Ω] (±20%)	Rated current ※) [mA]		Measuring frequency [kHz]
						Saturation current Idc1	Temperature rise current Idc2	
LCXND5050MKT1R0NMG	NRS5012T 1R0NMGFV	1.0	±30%	100	0.053	4,500	2,300	100
LCXND5050MKT1R5NMG	NRS5012T 1R5NMGFV	1.5	±30%	86	0.070	3,800	2,200	100
LCXND5050MKT2R2MMG	NRS5012T 2R2MMGFV	2.2	±20%	70	0.085	3,100	2,000	100
LCXND5050MKT3R3MMG	NRS5012T 3R3MMGFV	3.3	±20%	48	0.160	2,400	1,450	100
LCXND5050MKT4R7MMG	NRS5012T 4R7MMGFV	4.7	±20%	40	0.180	2,200	1,400	100
LCXND5050MKT6R8MMG	NRS5012T 6R8MMGFV	6.8	±20%	36	0.260	1,700	1,100	100
LCXND5050MKT100MMG	NRS5012T 100MMGFV	10	±20%	26	0.420	1,400	850	100
LCXND5050MKT150MMG	NRS5012T 150MMGFV	15	±20%	22	0.670	1,200	640	100

● 5050PK type

New part number	Old part number (for reference)	Nominal inductance [μH]	Inductance tolerance	Self-resonant frequency [MHz] (min.)	DC Resistance [Ω] (±20%)	Rated current ※) [mA]		Measuring frequency [kHz]
						Saturation current Idc1	Temperature rise current Idc2	
LCXND5050PKTR47NMG	NRS5014T R47NMGJV	0.47	±30%	185	0.025	5,800	3,300	100
LCXND5050PKT1R2NMG	NRS5014T 1R2NMGJV	1.2	±30%	86	0.045	3,800	2,400	100
LCXND5050PKT2R2NMG	NRS5014T 2R2NMGJV	2.2	±30%	56	0.065	2,800	2,000	100
LCXND5050PKT3R3NMG	NRS5014T 3R3NMGJV	3.3	±30%	48	0.080	2,350	1,700	100
LCXND5050PKT4R7NMG	NRS5014T 4R7NMGJV	4.7	±30%	41	0.100	2,050	1,400	100
LCXND5050PKT6R8MMG	NRS5014T 6R8MMGJV	6.8	±20%	33	0.150	1,600	1,200	100
LCXND5050PKT100MMG	NRS5014T 100MMGJV	10	±20%	27	0.200	1,400	1,050	100
LCXND5050PKT150MMG	NRS5014T 150MMGJV	15	±20%	20	0.320	1,100	650	100
LCXND5050PKT220MMG	NRS5014T 220MMGJV	22	±20%	16	0.450	900	550	100

● 5020WK type

New part number	Old part number (for reference)	Nominal inductance [μH]	Inductance tolerance	Self-resonant frequency [MHz] (min.)	DC Resistance [Ω] (±20%)	Rated current ※) [mA]		Measuring frequency [kHz]
						Saturation current Idc1	Temperature rise current Idc2	
LCXND5050WKT4R7NMG	NRS5020T R47NMGJV	0.47	±30%	230	0.012	6,100	5,000	100
LCXND5050WKT1R0NMG	NRS5020T 1R0NMGJV	1.0	±30%	81	0.021	4,000	3,600	100
LCXND5050WKT1R5NMG	NRS5020T 1R5NMGJV	1.5	±30%	68	0.026	3,350	3,200	100
LCXND5050WKT2R2NMG	NRS5020T 2R2NMGJV	2.2	±30%	57	0.035	2,900	2,900	100
LCXND5050WKT3R3NMG	NRS5020T 3R3NMGJV	3.3	±30%	46	0.048	2,400	2,400	100
LCXND5050WKT4R7MMG	NRS5020T 4R7MMGJV	4.7	±20%	37	0.060	2,000	2,000	100
LCXND5050WKT6R8MMG	NRS5020T 6R8MMGJV	6.8	±20%	30	0.090	1,600	1,650	100
LCXND5050WKT100MMG	NRS5020T 100MMGJV	10	±20%	24	0.120	1,300	1,450	100
LCXND5050WKT150MMG	NRS5020T 150MMGJV	15	±20%	20	0.165	1,100	1,200	100
LCXND5050WKT220MMG	NRS5020T 220MMGJV	22	±20%	17	0.260	900	1,000	100
LCXND5050WKT470MMG	NRS5020T 470MMGJV	47	±20%	12	0.435	630	560	100
LCXND5050WKT101MMG	NRS5020T 101MMGJV	100	±20%	7	0.850	420	400	100

※) The saturation current value (Idc1) is the DC current value having inductance decrease down to 30%. (at 20°C)

※) The temperature rise current value (Idc2) is the DC current value having temperature increase up to 40°C. (at 20°C)

※) The rated current is the DC current value that satisfies both of current value saturation current value and temperature rise current value.

■ PART NUMBER

● 5050WE/5050WD type

New part number	Old part number (for reference)	Nominal inductance [μH]	Inductance tolerance	Self-resonant frequency [MHz] (min.)	DC Resistance [Ω] (±20%)	Rated current ※) [mA]		Measuring frequency [kHz]
						Saturation current Idc1	Temperature rise current Idc2	
LXND5050WEL1R0NMG	NRS5024T 1R0NMGJV	1.0	±30%	85	0.016	5,800	4,400	100
LXND5050WEL1R5NMG	NRS5024T 1R5NMGJV	1.5	±30%	67	0.022	5,200	3,600	100
LXND5050WDL2R2NMG	NRS5024T 2R2NMGJV	2.2	±30%	51	0.029	4,100	3,100	100
LXND5050WDL3R3NMG	NRS5024T 3R3NMGJV	3.3	±30%	41	0.043	3,100	2,400	100
LXND5050WDL4R7MMG	NRS5024T 4R7MMGJV	4.7	±20%	37	0.055	2,700	2,000	100
LXND5050WDL6R8MMG	NRS5024T 6R8MMGJV	6.8	±20%	28	0.080	2,200	1,600	100
LXND5050WDL100MMG	NRS5024T 100MMGJV	10	±20%	21	0.125	1,700	1,200	100
LXND5050WDL150MMG	NRS5024T 150MMGJV	15	±20%	18	0.170	1,400	1,000	100
LXND5050WDL220MMG	NRS5024T 220MMGJV	22	±20%	15	0.230	1,200	820	100
LXND5050WDL330MMG	NRS5024T 330MMGJV	33	±20%	11	0.370	1,000	630	100

● 5050XA/5050XK type

New part number	Old part number (for reference)	Nominal inductance [μH]	Inductance tolerance	Self-resonant frequency [MHz] (min.)	DC Resistance [Ω] (±30%)	Rated current ※) [mA]		Measuring frequency [kHz]
						Saturation current Idc1	Temperature rise current Idc2	
LXND5050XATR47NMG	NRS5030T R47NMGJV	0.47	±30%	185	0.010	9,000	5,000	100
LXND5050XAT1R0NMG	NRS5030T 1R0NMGJV	1.0	±30%	110	0.015	6,600	4,000	100
LXND5050XAT2R2NMG	NRS5030T 2R2NMGJV	2.2	±30%	46	0.023	4,200	3,500	100
LXND5050XAT3R3MMG	NRS5030T 3R3MMGJV	3.3	±20%	36	0.030	3,600	3,000	100
LXND5050XAT4R7MMG	NRS5030T 4R7MMGJV	4.7	±20%	31	0.035	3,100	2,600	100
LXND5050XAT6R8MMG	NRS5030T 6R8MMGJV	6.8	±20%	22	0.052	2,500	2,300	100
LXND5050XAT100MMG	NRS5030T 100MMGJV	10	±20%	20	0.070	2,100	1,700	100
LXND5050XKT150MMG	NRS5030T 150MMGJV	15	±20%	14	0.125	1,600	1,400	100
LXND5050XKT220MMG	NRS5030T 220MMGJV	22	±20%	13	0.180	1,400	1,050	100
LXND5050XKT330MMG	NRS5030T 330MMGJV	33	±20%	10	0.225	1,150	800	100
LXND5050XKT470MMG	NRS5030T 470MMGJV	47	±20%	9	0.325	950	700	100

● 5050YA/5050YK type

New part number	Old part number (for reference)	Nominal inductance [μH]	Inductance tolerance	Self-resonant frequency [MHz] (min.)	DC Resistance [Ω] (±30%)	Rated current ※) [mA]		Measuring frequency [kHz]
						Saturation current Idc1	Temperature rise current Idc2	
LXND5050YAL1R5NMG	NRS5040T 1R5NMGJV	1.5	±30%	60	0.017	6,400	4,500	100
LXND5050YAL2R2NMG	NRS5040T 2R2NMGJV	2.2	±30%	42	0.022	5,000	3,700	100
LXND5050YAL3R3NMG	NRS5040T 3R3NMGJV	3.3	±30%	32	0.027	4,000	3,300	100
LXND5050YAL4R7NMG	NRS5040T 4R7NMGJV	4.7	±30%	28	0.029	3,300	3,100	100
LXND5050YAL6R8MMG	NRS5040T 6R8MMGJV	6.8	±20%	21	0.049	2,800	2,400	100
LXND5050YAL100MMG	NRS5040T 100MMGJV	10	±20%	18	0.056	2,300	2,100	100
LXND5050YKL150MMG	NRS5040T 150MMGJV	15	±20%	13	0.080	2,000	1,800	100
LXND5050YKL220MMG	NRS5040T 220MMGJV	22	±20%	9	0.126	1,500	1,400	100
LXND5050YKL330MMG	NRS5040T 330MMGJV	33	±20%	7	0.180	1,300	1,200	100
LXND5050YKL470MMG	NRS5040T 470MMGJV	47	±20%	6	0.310	1,100	900	100

● 6060KK type

New part number	Old part number (for reference)	Nominal inductance [μH]	Inductance tolerance	Self-resonant frequency [MHz] (min.)	DC Resistance [Ω] (±20%)	Rated current ※) [mA]		Measuring frequency [kHz]
						Saturation current Idc1	Temperature rise current Idc2	
LXND6060KKT1R5MMG	NRS6010T 1R5MMGFV	1.5	±20%	77	0.090	2,400	1,900	100
LXND6060KKT2R2MMG	NRS6010T 2R2MMGFV	2.2	±20%	56	0.110	1,900	1,700	100
LXND6060KKT3R3MMG	NRS6010T 3R3MMGFV	3.3	±20%	42	0.135	1,600	1,500	100
LXND6060KKT4R7MMG	NRS6010T 4R7MMGFV	4.7	±20%	36	0.165	1,300	1,400	100
LXND6060KKT6R8MMG	NRS6010T 6R8MMGFV	6.8	±20%	30	0.220	1,200	1,200	100
LXND6060KKT100MMG	NRS6010T 100MMGFV	10	±20%	25	0.270	1,000	1,100	100
LXND6060KKT220MMG	NRS6010T 220MMGFV	22	±20%	12	0.580	650	700	100

● 6060MK type

New part number	Old part number (for reference)	Nominal inductance [μH]	Inductance tolerance	Self-resonant frequency [MHz] (min.)	DC Resistance [Ω] (±20%)	Rated current ※) [mA]		Measuring frequency [kHz]
						Saturation current Idc1	Temperature rise current Idc2	
LXND6060MKT1R0NMG	NRS6012T 1R0NMGJV	1.0	±30%	95	0.050	3,000	2,400	100
LXND6060MKT1R5NMG	NRS6012T 1R5NMGJV	1.5	±30%	69	0.067	2,600	2,100	100
LXND6060MKT2R5NMG	NRS6012T 2R5NMGJV	2.5	±30%	45	0.090	2,100	1,800	100
LXND6060MKT3R3NMG	NRS6012T 3R3NMGJV	3.3	±30%	42	0.105	1,800	1,700	100
LXND6060MKT4R7MMG	NRS6012T 4R7MMGJV	4.7	±20%	36	0.125	1,600	1,550	100
LXND6060MKT5R3MMG	NRS6012T 5R3MMGJV	5.3	±20%	34	0.125	1,500	1,550	100
LXND6060MKT6R8MMG	NRS6012T 6R8MMGJV	6.8	±20%	30	0.165	1,300	1,350	100
LXND6060MKT100MMG	NRS6012T 100MMGJV	10	±20%	22	0.200	1,000	1,200	100
LXND6060MKT150MMG	NRS6012T 150MMGJV	15	±20%	18	0.295	800	800	100
LXND6060MKT220MMG	NRS6012T 220MMGJV	22	±20%	12	0.465	760	650	100
LXND6060MKT330MMG	NRS6012T 330MMGJV	33	±20%	8	0.580	590	550	100
LXND6060MKT470MMG	NRS6012T 470MMGJV	47	±20%	6	0.965	520	460	100
LXND6060MKT680MMG	NRS6012T 680MMGJV	68	±20%	3	1.16	440	410	100
LXND6060MKT101MMG	NRS6012T 101MMGJV	100	±20%	1	1.67	350	320	100

※) The saturation current value (Idc1) is the DC current value having inductance decrease down to 30%. (at 20°C)

※) The temperature rise current value (Idc2) is the DC current value having temperature increase up to 40°C. (at 20°C)

※) The rated current is the DC current value that satisfies both of current value saturation current value and temperature rise current value.

## PART NUMBER

## 6060PK type

New part number	Old part number (for reference)	Nominal inductance [ $\mu$ H]	Inductance tolerance	Self-resonant frequency [MHz] (min.)	DC Resistance [ $\Omega$ ] ( $\pm 20\%$ )	Rated current ※) [mA]		Measuring frequency [kHz]
						Saturation current Idc1	Temperature rise current Idc2	
LCXND6060PKT1R2NMG	NRS6014T 1R2NMGV	1.2	$\pm 30\%$	77	0.042	4,000	2,750	100
LCXND6060PKT2R2NMG	NRS6014T 2R2NMGV	2.2	$\pm 30\%$	61	0.055	3,000	2,300	100
LCXND6060PKT3R3NMG	NRS6014T 3R3NMGV	3.3	$\pm 30\%$	41	0.075	2,500	2,000	100
LCXND6060PKT4R7MMG	NRS6014T 4R7MMGV	4.7	$\pm 20\%$	36	0.090	2,000	1,900	100
LCXND6060PKT6R8MMG	NRS6014T 6R8MMGV	6.8	$\pm 20\%$	30	0.115	1,700	1,650	100
LCXND6060PKT100MMG	NRS6014T 100MMGV	10	$\pm 20\%$	24	0.140	1,400	1,400	100
LCXND6060PKT150MMG	NRS6014T 150MMGV	15	$\pm 20\%$	20	0.210	1,150	1,200	100
LCXND6060PKT220MMG	NRS6014T 220MMGV	22	$\pm 20\%$	16	0.300	950	1,000	100

## 6060WK type

New part number	Old part number (for reference)	Nominal inductance [ $\mu$ H]	Inductance tolerance	Self-resonant frequency [MHz] (min.)	DC Resistance [ $\Omega$ ] ( $\pm 20\%$ )	Rated current ※) [mA]		Measuring frequency [kHz]
						Saturation current Idc1	Temperature rise current Idc2	
LCXND6060WKL0R8NMG	NRS6020T 0R8NMGV	0.8	$\pm 30\%$	110	0.020	6,400	4,100	100
LCXND6060WKL1R5NMG	NRS6020T 1R5NMGV	1.5	$\pm 30\%$	93	0.026	4,300	3,600	100
LCXND6060WKL2R2NMG	NRS6020T 2R2NMGV	2.2	$\pm 30\%$	73	0.034	3,200	2,900	100
LCXND6060WKL3R3NMG	NRS6020T 3R3NMGV	3.3	$\pm 30\%$	55	0.040	2,800	2,750	100
LCXND6060WKL4R7NMG	NRS6020T 4R7NMGV	4.7	$\pm 30\%$	43	0.058	2,400	2,150	100
LCXND6060WKL6R8NMG	NRS6020T 6R8NMGV	6.8	$\pm 30\%$	30	0.085	2,000	1,800	100
LCXND6060WKL100MMG	NRS6020T 100MMGV	10	$\pm 20\%$	18	0.125	1,900	1,500	100
LCXND6060WKL220MMG	NRS6020T 220MMGV	22	$\pm 20\%$	11	0.290	1,250	950	100

## 6060WH type

New part number	Old part number (for reference)	Nominal inductance [ $\mu$ H]	Inductance tolerance	Self-resonant frequency [MHz] (min.)	DC Resistance [ $\Omega$ ] ( $\pm 30\%$ )	Rated current ※) [mA]		Measuring frequency [kHz]
						Saturation current Idc1	Temperature rise current Idc2	
LCXND6060WHL0R9NMG	NRS6028T 0R9NMGV	0.9	$\pm 30\%$	90	0.013	6,700	4,600	100
LCXND6060WHL1R5NMG	NRS6028T 1R5NMGV	1.5	$\pm 30\%$	78	0.016	5,100	4,200	100
LCXND6060WHL2R2NMG	NRS6028T 2R2NMGV	2.2	$\pm 30\%$	68	0.020	4,200	3,700	100
LCXND6060WHL3R0NMG	NRS6028T 3R0NMGV	3.0	$\pm 30\%$	55	0.023	3,600	3,400	100
LCXND6060WHL4R7MMG	NRS6028T 4R7MMGV	4.7	$\pm 20\%$	39	0.031	2,700	3,000	100
LCXND6060WHL6R8MMG	NRS6028T 6R8MMGV	6.8	$\pm 20\%$	25	0.043	2,600	2,500	100
LCXND6060WHL100MMG	NRS6028T 100MMGV	10	$\pm 20\%$	20	0.065	1,900	1,900	100
LCXND6060WHL150MMG	NRS6028T 150MMGV	15	$\pm 20\%$	17	0.095	1,600	1,800	100
LCXND6060WHL220MMG	NRS6028T 220MMGV	22	$\pm 20\%$	12	0.135	1,300	1,400	100
LCXND6060WHL330MMG	NRS6028T 330MMGV	33	$\pm 20\%$	10	0.220	1,100	1,100	100
LCXND6060WHL470MMG	NRS6028T 470MMGV	47	$\pm 20\%$	8	0.300	1,000	920	100
LCXND6060WHL680MMG	NRS6028T 680MMGV	68	$\pm 20\%$	5	0.420	800	770	100
LCXND6060WHL101MMG	NRS6028T 101MMGV	100	$\pm 20\%$	3	0.600	650	660	100

## 6060YE type

New part number	Old part number (for reference)	Nominal inductance [ $\mu$ H]	Inductance tolerance	Self-resonant frequency [MHz] (min.)	DC Resistance [ $\Omega$ ] ( $\pm 30\%$ )	Rated current ※) [mA]		Measuring frequency [kHz]
						Saturation current Idc1	Temperature rise current Idc2	
LCXND6060YEL1R0NMG	NRS6045T 1R0NMGV	1.0	$\pm 30\%$	110	0.014	9,800	4,500	100
LCXND6060YEL1R3NMG	NRS6045T 1R3NMGV	1.3	$\pm 30\%$	95	0.016	8,200	4,200	100
LCXND6060YEL1R8NMG	NRS6045T 1R8NMGV	1.8	$\pm 30\%$	80	0.019	7,200	3,900	100
LCXND6060YEL2R3NMG	NRS6045T 2R3NMGV	2.3	$\pm 30\%$	60	0.022	6,400	3,600	100
LCXND6060YEL3R0NMG	NRS6045T 3R0NMGV	3.0	$\pm 30\%$	45	0.024	5,600	3,300	100
LCXND6060YEL4R5MMG	NRS6045T 4R5MMGV	4.5	$\pm 20\%$	25	0.030	4,400	3,100	100
LCXND6060YEL6R3MMG	NRS6045T 6R3MMGV	6.3	$\pm 20\%$	15	0.036	3,600	3,000	100
LCXND6060YEL100MMG	NRS6045T 100MMGV	10	$\pm 20\%$	12	0.046	3,100	2,400	100
LCXND6060YEL150MMG	NRS6045T 150MMGV	15	$\pm 20\%$	10	0.070	2,500	1,900	100
LCXND6060YEL220MMG	NRS6045T 220MMGV	22	$\pm 20\%$	7	0.107	2,000	1,600	100
LCXND6060YEL330MMG	NRS6045T 330MMGV	33	$\pm 20\%$	6	0.141	1,650	1,400	100
LCXND6060YEL470MMG	NRS6045T 470MMGV	47	$\pm 20\%$	5	0.211	1,400	1,150	100
LCXND6060YEL680MMG	NRS6045T 680MMGV	68	$\pm 20\%$	4	0.304	1,100	950	100
LCXND6060YEL101MMG	NRS6045T 101MMGV	100	$\pm 20\%$	3	0.466	900	750	100

## 8080XK type

New part number	Old part number (for reference)	Nominal inductance [ $\mu$ H]	Inductance tolerance	Self-resonant frequency [MHz] (min.)	DC Resistance [ $\Omega$ ] ( $\pm 30\%$ )	Rated current ※) [mA]		Measuring frequency [kHz]
						Saturation current Idc1	Temperature rise current Idc2	
LCXNH8080XKL1R0NJG	NRS8030T 1R0NJGV	1.0	$\pm 30\%$	120	0.009	7,800	6,200	100
LCXNH8080XKL1R5NJG	NRS8030T 1R5NJGV	1.5	$\pm 30\%$	80	0.012	6,200	5,300	100
LCXNH8080XKL2R2NJG	NRS8030T 2R2NJGV	2.2	$\pm 30\%$	60	0.015	4,900	4,800	100
LCXNH8080XKL3R3MJG	NRS8030T 3R3MJGV	3.3	$\pm 20\%$	50	0.019	4,200	4,300	100
LCXNH8080XKL4R7MJG	NRS8030T 4R7MJGV	4.7	$\pm 20\%$	40	0.022	3,600	4,000	100
LCXNH8080XKL6R8MJG	NRS8030T 6R8MJGV	6.8	$\pm 20\%$	32	0.029	3,000	3,400	100
LCXNH8080XKL100MJG	NRS8030T 100MJGV	10	$\pm 20\%$	27	0.033	2,400	3,000	100
LCXNH8080XKL150MJG	NRS8030T 150MJGV	15	$\pm 20\%$	20	0.060	2,000	2,200	100
LCXNH8080XKL220MJG	NRS8030T 220MJGV	22	$\pm 20\%$	16	0.070	1,750	1,900	100
LCXNH8080XKL330MJG	NRS8030T 330MJGV	33	$\pm 20\%$	13	0.120	1,300	1,500	100
LCXNH8080XKL470MJG	NRS8030T 470MJGV	47	$\pm 20\%$	11	0.170	1,100	1,300	100

※) The saturation current value (Idc1) is the DC current value having inductance decrease down to 30%. (at 20°C)

※) The temperature rise current value (Idc2) is the DC current value having temperature increase up to 40°C. (at 20°C)

※) The rated current is the DC current value that satisfies both of current value saturation current value and temperature rise current value.

## PART NUMBER

## 8080YB/8080YK type

New part number	Old part number (for reference)	Nominal inductance [ $\mu$ H]	Inductance tolerance	Self-resonant frequency [MHz] (min.)	DC Resistance [ $\Omega$ ] ( $\pm 30\%$ )	Rated current ※) [mA]		Measuring frequency [kHz]
						Saturation current Idc1	Temperature rise current Idc2	
LCXNH8080YBL0R9NJG	NRS8040T 0R9NJGJV	0.9	$\pm 30\%$	85	0.006	13,000	7,800	100
LCXNH8080YBL1R4NJG	NRS8040T 1R4NJGJV	1.4	$\pm 30\%$	63	0.007	10,000	7,000	100
LCXNH8080YBL2R0NJG	NRS8040T 2R0NJGJV	2.0	$\pm 30\%$	50	0.009	8,100	6,300	100
LCXNH8080YBL3R6NJG	NRS8040T 3R6NJGJV	3.6	$\pm 30\%$	34	0.015	6,400	4,900	100
LCXNH8080YBL4R7NJG	NRS8040T 4R7NJGJV	4.7	$\pm 30\%$	30	0.018	5,400	4,100	100
LCXNH8080YBL6R8NJG	NRS8040T 6R8NJGJV	6.8	$\pm 30\%$	24	0.025	4,400	3,700	100
LCXNH8080YKL100MJG	NRS8040T 100MJGJV	10	$\pm 20\%$	22	0.034	3,800	3,100	100
LCXNH8080YKL150MJG	NRS8040T 150MJGJV	15	$\pm 20\%$	16	0.050	2,900	2,400	100
LCXNH8080YKL220MJG	NRS8040T 220MJGJV	22	$\pm 20\%$	13	0.066	2,400	2,200	100
LCXNH8080YKL330MJG	NRS8040T 330MJGKV	33	$\pm 20\%$	12	0.100	2,000	1,700	100
LCXNH8080YKL470MJG	NRS8040T 470MJGKV	47	$\pm 20\%$	8	0.140	1,500	1,500	100
LCXNH8080YKL680MJG	NRS8040T 680MJGKV	68	$\pm 20\%$	7	0.210	1,300	1,200	100
LCXNH8080YKL101MJG	NRS8040T 101MJGKV	100	$\pm 20\%$	6	0.280	1,100	1,000	100

※) The saturation current value (Idc1) is the DC current value having inductance decrease down to 30%. (at 20°C)

※) The temperature rise current value (Idc2) is the DC current value having temperature increase up to 40°C. (at 20°C)

※) The rated current is the DC current value that satisfies both of current value saturation current value and temperature rise current value.

Derating of Rated Current

LCXN/LCXP series

Derating of current is necessary for LCXN/LCXP series depending on ambient temperature. Please refer to the chart shown below for appropriate derating of current.

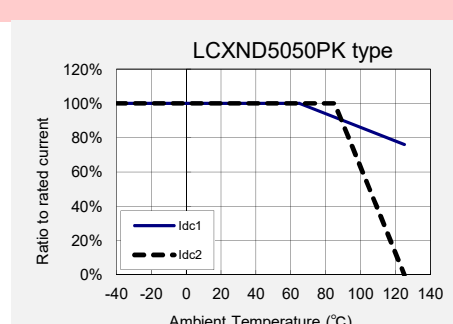
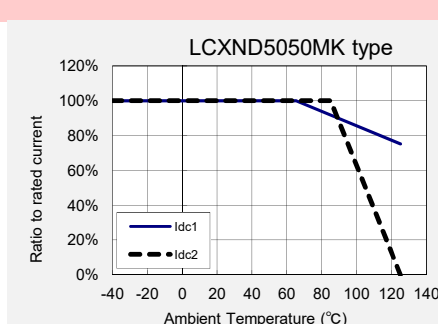
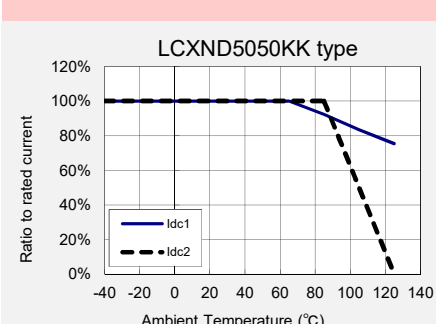
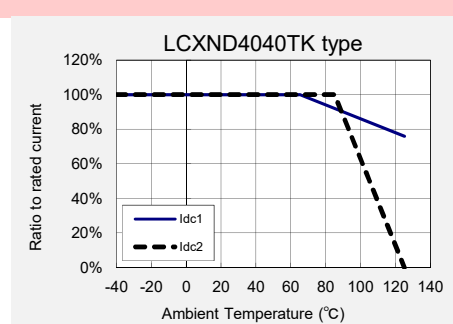
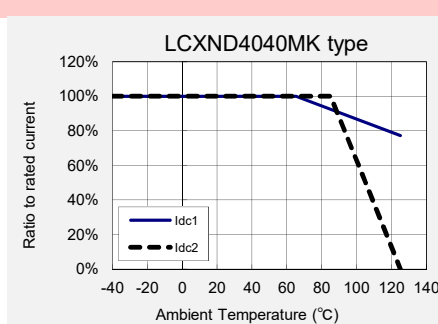
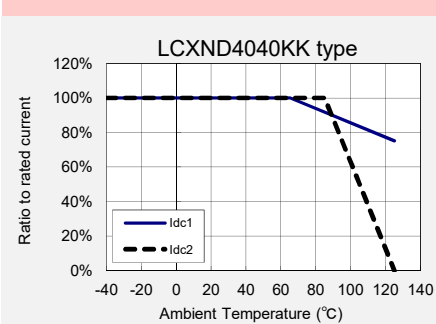
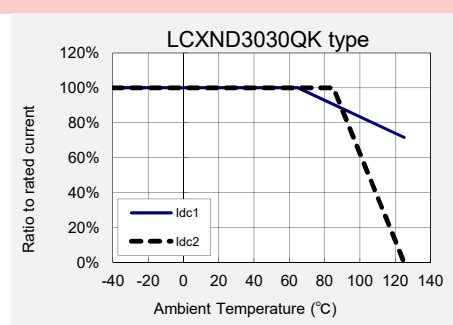
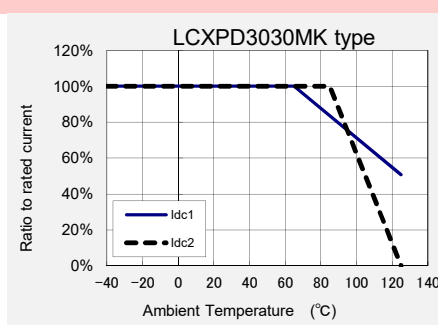
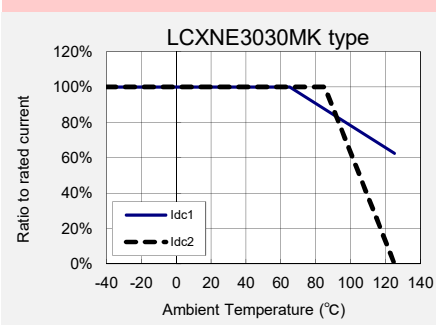
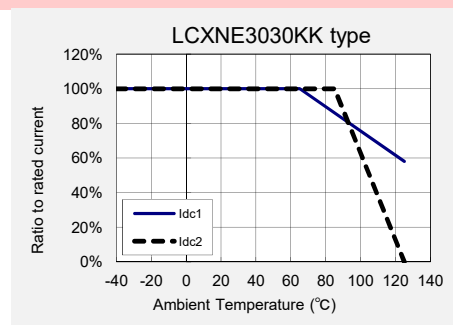
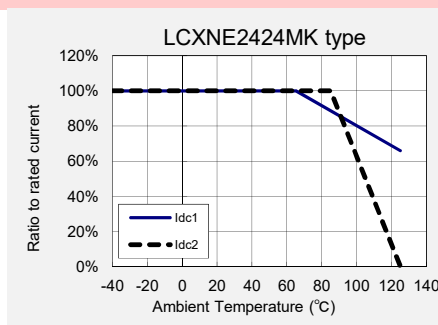
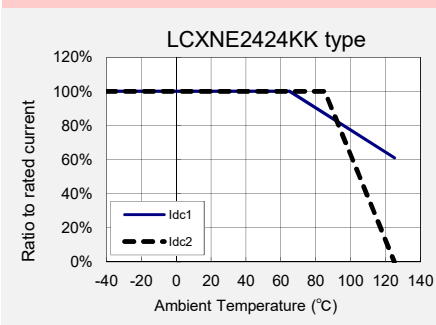
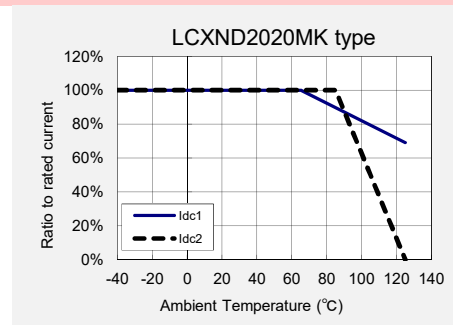
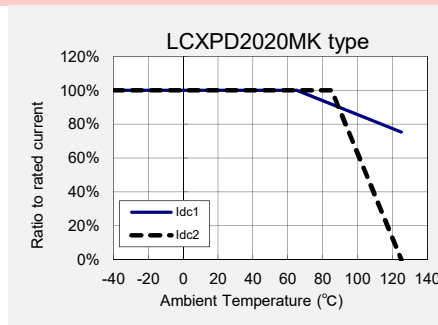
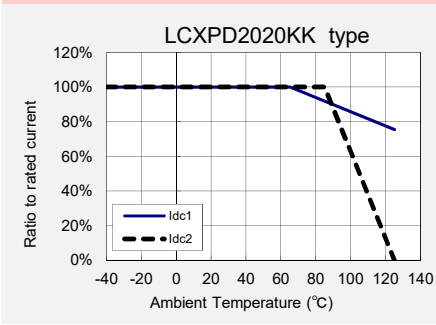

▶ This catalog contains the typical specification only due to the limitation of space. When you consider the purchase of our products, please check our specification. For details of each product (characteristics graph, reliability information, precautions for use, and so on), see our Web site (<http://www.ty-top.com/>).

Derating of Rated Current

LCXN/LCXP series

Derating of current is necessary for LCXN/LCXP series depending on ambient temperature. Please refer to the chart shown below for appropriate derating of current.

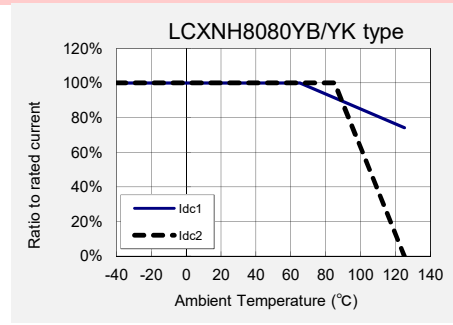
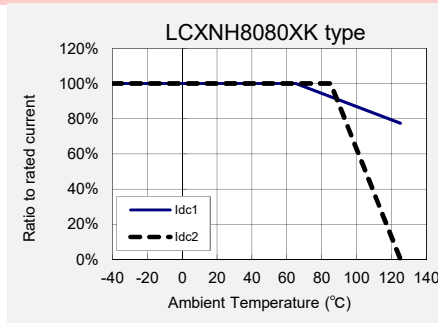
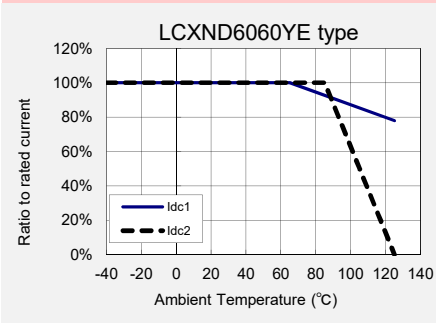
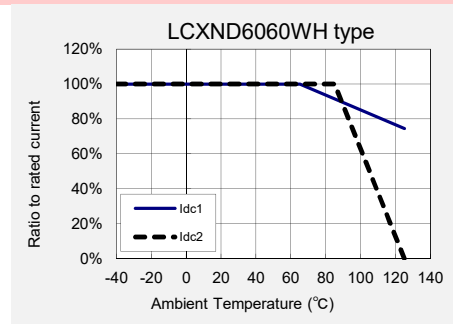
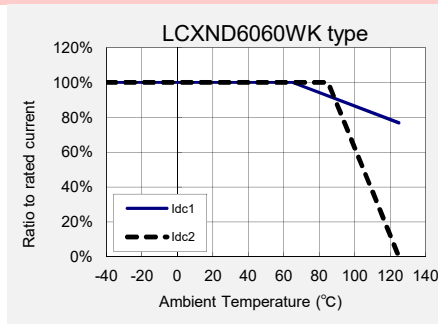
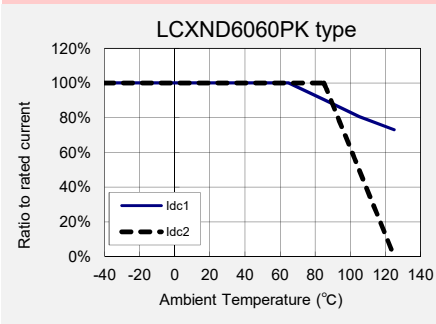
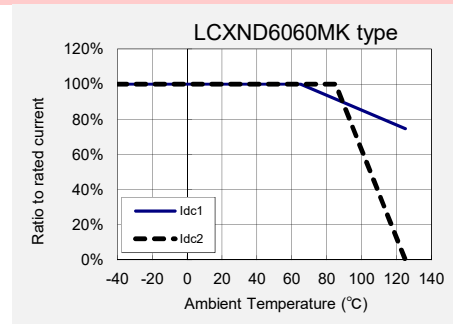
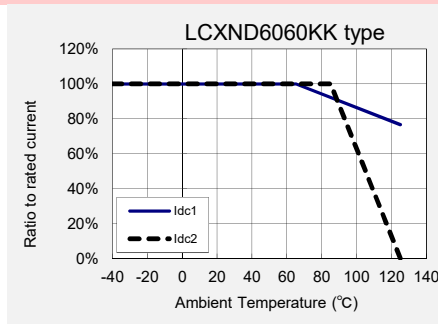
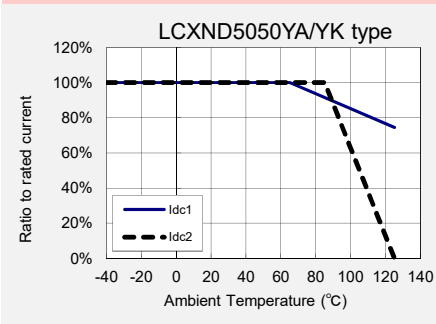
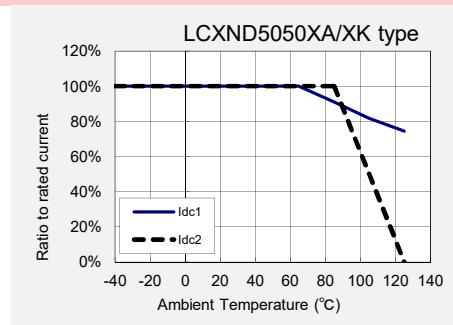
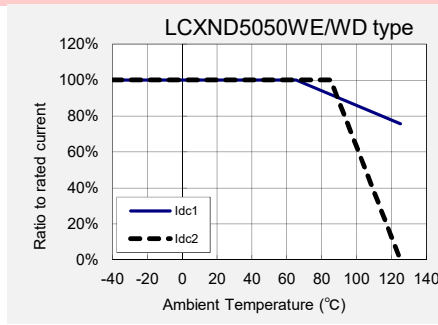
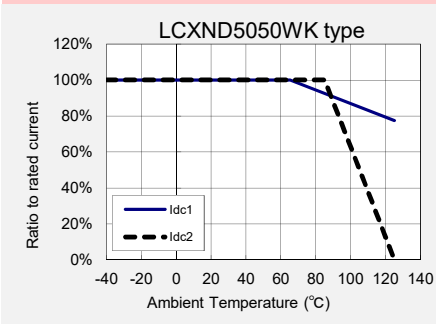

► This catalog contains the typical specification only due to the limitation of space. When you consider the purchase of our products, please check our specification. For details of each product (characteristics graph, reliability information, precautions for use, and so on), see our Web site (<http://www.ty-top.com/>).

Wire-wound Ferrite Power Inductors LSXB/LSXN/LSXP/LCXN/LCXP/LBXN/LBXP/  
 LLXB/LLXN/LLXP/LMXN/LMXP series  
 Wire-wound Ferrite Power Inductors LCXH/LBXH/LMXH series  
 Wire-wound Ferrite Inductors for Class D Amplifier LCXA

PACKAGING

① Minimum Quantity

Type	Standard Quantity [pcs]
	Tape & Reel
2020KK	2500
2020MK	2500
2424KK	2500
2424MK	2500
3030KK	2000
3030MK	2000
3030QK	2000
4040KK	5000
4040MK	4500
4040TK	3500
4040WK	700

Type	Standard Quantity [pcs]
	Tape & Reel
5050KK	1000
5050MK	1000
5050PK	1000
5050WB	800
5050WK	800
5050WD	2500
5050WE	2500
5050XK	500
5050XA	500
5050YA	1500
5050YK	1500
6060KK	1000
6060MK	1000
6060PK	1000
6060WK	2500
6060WH	2000
6060YE	1500
8080XK	1000
8080YK	1000
8080YB	1000

② Tape Material

Embossed Tape

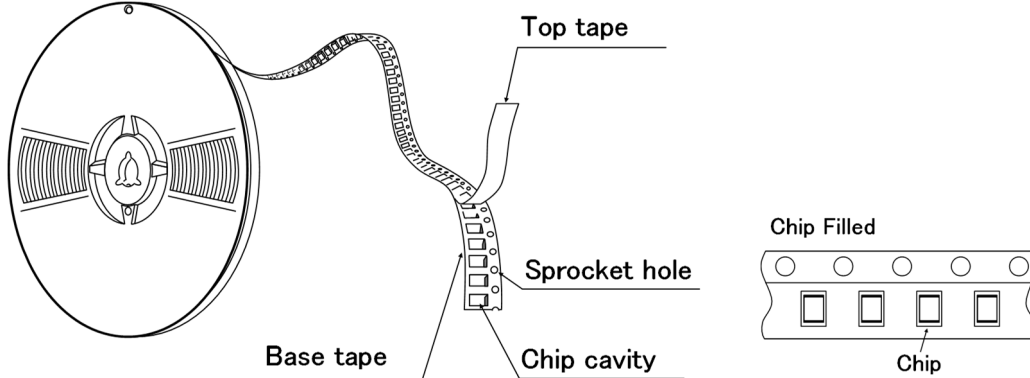

③ Taping dimensions

Embossed tape 8mm wide (0.315 inches wide)

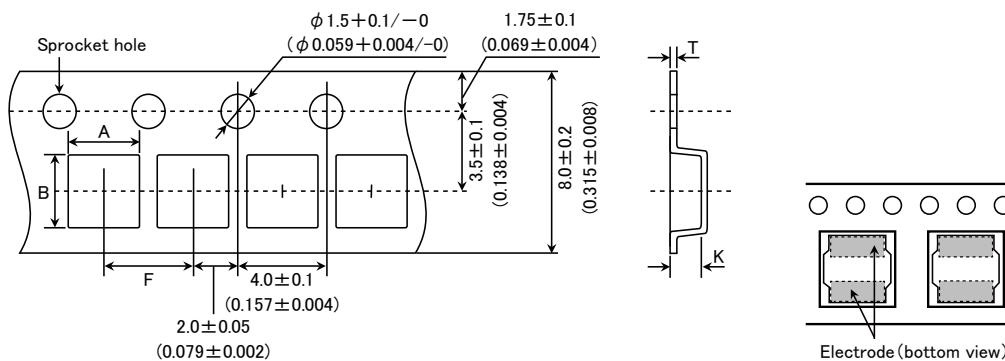

\* This catalog contains the typical specification only due to the limitation of space. When you consider the purchase of our products, please check our specification. For details of each product (characteristics graph, reliability information, precautions for use, and so on), see our Web site (<http://www.ty-top.com/>).

Type	Chip cavity		Insertion pitch F	Tape thickness	
	A	B		T	K
2020KK 2020MK	2.2±0.1 (0.102±0.004)	2.2±0.1 (0.102±0.004)	4.0±0.1 (0.157±0.004)	0.25±0.05 (0.009±0.002)	1.3±0.1 (0.051±0.004)
2424KK 2424MK	2.6±0.1 (0.087±0.004)	2.6±0.1 (0.102±0.004)		0.25±0.05 (0.009±0.002)	1.3±0.1 (0.051±0.004)
3030KK	3.2±0.1 (0.126±0.004)	3.2±0.1 (0.126±0.004)		0.3±0.05 (0.012±0.002)	1.4±0.1 (0.055±0.004)
3030MK					1.6±0.1 (0.063±0.004)
3030QK					1.9±0.1 (0.075±0.004)

Unit: mm (inch)

● Embossed tape 12mm wide (0.47 inches wide)

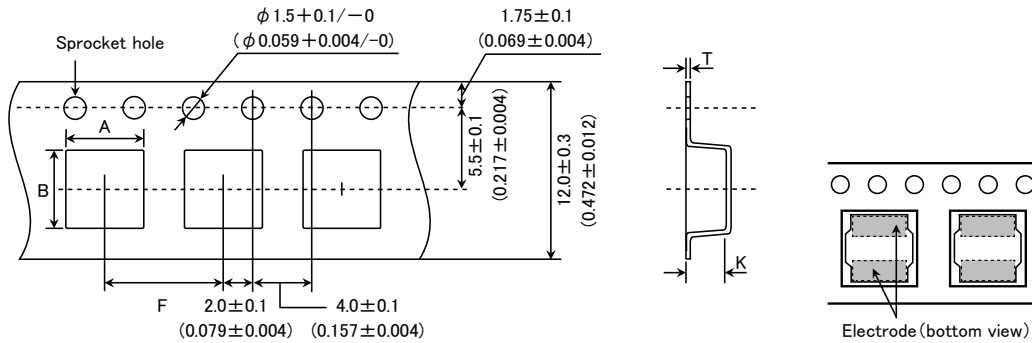

Type	Chip cavity		Insertion pitch F	Tape thickness			
	A	B		T	K		
4040KK	4.3±0.1 (0.169±0.004)	4.3±0.1 (0.169±0.004)	8.0±0.1 (0.315±0.004)	0.3±0.1 (0.012±0.004)	1.4±0.1 (0.055±0.004)		
4040MK					1.6±0.1 (0.063±0.004)		
4040TK 4040WK					2.1±0.1 (0.083±0.004)		
5050KK	5.25±0.1 (0.207±0.004)	5.25±0.1 (0.207±0.004)			1.4±0.1 (0.055±0.004)		
5050MK						1.4±0.1 (0.055±0.004)	
5050PK						1.6±0.1 (0.063±0.004)	
5050WB 5050WK						2.3±0.1 (0.091±0.004)	
5050WD 5050WE						2.7±0.1 (0.106±0.004)	
5050XK 5050XA	5.15±0.1 (0.203±0.004)	5.15±0.1 (0.203±0.004)			0.4±0.1 (0.016±0.004)	0.4±0.1 (0.016±0.004)	3.2±0.1 (0.126±0.004)
5050YK 5050YA	5.15±0.1 (0.203±0.004)	5.15±0.1 (0.203±0.004)					4.2±0.1 (0.165±0.004)
6060KK	6.3±0.1 (0.248±0.004)	6.3±0.1 (0.248±0.004)	1.4±0.1 (0.055±0.004)				
6060MK				1.6±0.1 (0.063±0.004)			
6060PK				1.6±0.1 (0.063±0.004)			
6060WK				2.3±0.1 (0.090±0.004)			
6060WH				3.1±0.1 (0.122±0.004)			
6060YE				4.7±0.1 (0.185±0.004)			
							4.7±0.1 (0.185±0.004)

Unit: mm (inch)

► This catalog contains the typical specification only due to the limitation of space. When you consider the purchase of our products, please check our specification. For details of each product (characteristics graph, reliability information, precautions for use, and so on), see our Web site (<http://www.ty-top.com/>).



● Embossed tape 16mm wide (0.63 inches wide)

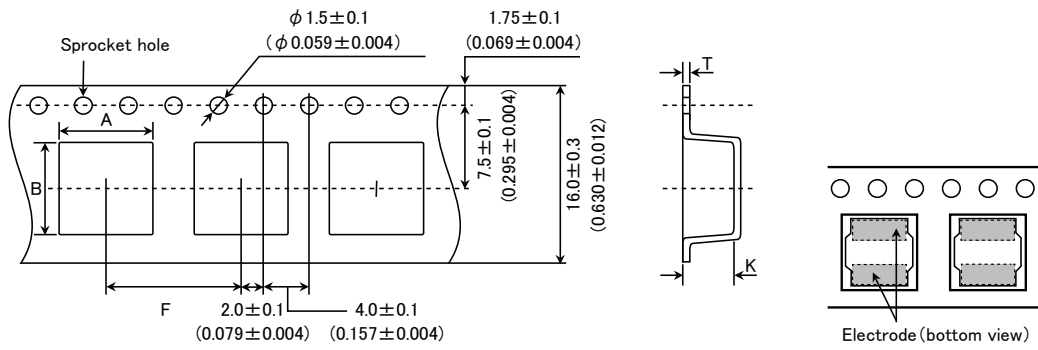

Type	Chip cavity		Insertion pitch F	Tape thickness	
	A	B		T	K
8080XK	$8.3 \pm 0.1$ (0.327 ± 0.004)	$8.3 \pm 0.1$ (0.327 ± 0.004)	$12.0 \pm 0.1$ (0.472 ± 0.004)	$0.5 \pm 0.1$ (0.020 ± 0.004)	$3.4 \pm 0.1$ (0.134 ± 0.004)
8080YK					$4.5 \pm 0.1$ (0.177 ± 0.004)
8080YB					$4.5 \pm 0.1$ (0.177 ± 0.004)

Unit : mm (inch)

#### ④ Leader and Blank portion

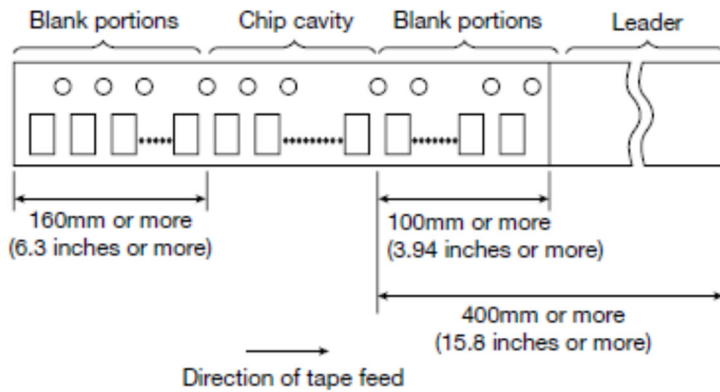

#### ⑤ Reel size

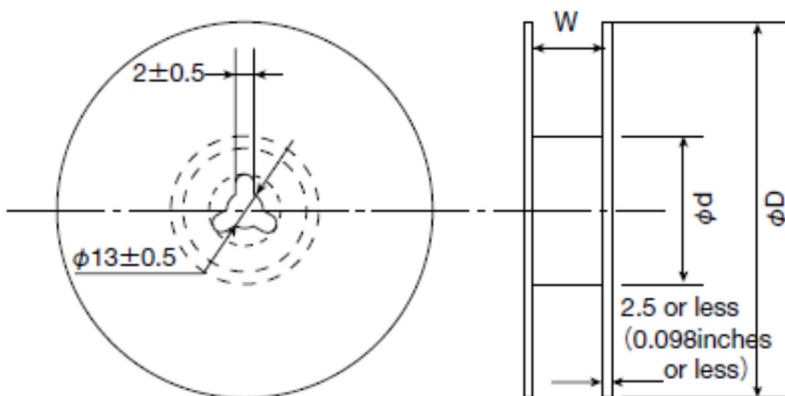

► This catalog contains the typical specification only due to the limitation of space. When you consider the purchase of our products, please check our specification. For details of each product (characteristics graph, reliability information, precautions for use, and so on), see our Web site (<http://www.ty-top.com/>).

Type	Reel size (Reference values)		
	$\phi D$	$\phi d$	W
2020KK	180±0.5 (7.087±0.019)	60±1.0 (2.36±0.04)	10.0±1.5 (0.394±0.059)
2020MK			
2424KK			
2424MK			
3030KK			
3030MK			
3030QK			
4040WK	180±3.0 (7.087±0.118)	60±2.0 (2.36±0.08)	14.0±1.5 (0.551±0.059)
5050KK			
5050MK			
5050PK			
5050WB			
5050WK			
5050XK			
5050XA			
6060KK			
6060MK			
6060PK			

Unit: mm (inch)

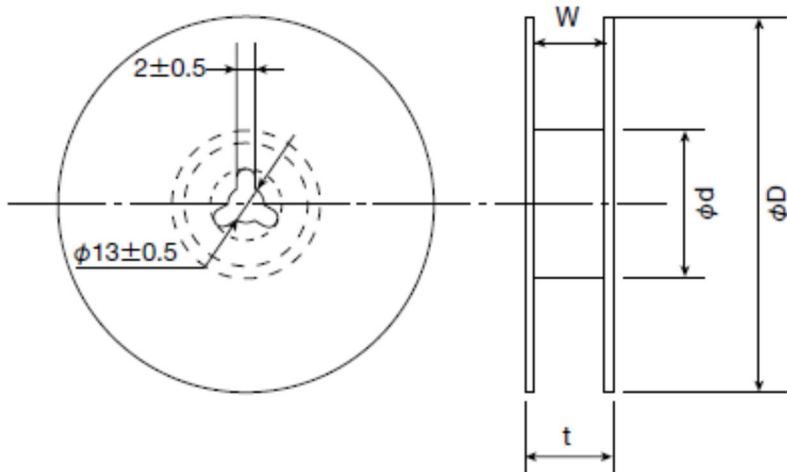

Type	Reel size (Reference values)			
	$\phi D$	$\phi d$	t (max.)	W
4040KK	330±3.0 (12.99±0.118)	80±2.0 (3.15±0.078)	18.5 (0.72)	13.5±1.0 (0.531±0.04)
4040MK				
4040TK				
5050WD				
5050WE				
5050YA				
5050YK			22.5 (0.89)	17.5±1.0 (0.689±0.04)
6060WK				
6060WH				
6060YE				
8080XK	22.5 (0.89)	17.5±1.0 (0.689±0.04)		
8080YK				
8080YB				

Unit: mm (inch)

### ⑥ Top Tape Strength

The top tape requires a peel-off force of 0.1 to 1.3N in the direction of the arrow as illustrated below.

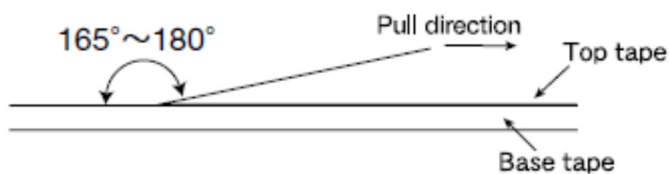

**Wire-wound Ferrite Power Inductors LCXN/LCXP series  
for Automotive Body & Chassis and Infotainment**  
**Wire-wound Ferrite Power Inductors LBXN/LBXP series  
for Telecommunications Infrastructure and Industrial Equipment**  
**Wire-wound Ferrite Power Inductors LMXN/LMXP series  
for Medical Devices classified as GHTF Class C (Japan Class III)**

■ RELIABILITY DATA

1. Operating Temperature Range													
Specified Value	-40~+125°C (Including self-generated heat)												
Test Methods and Remarks	Including self-generated heat												
2. Storage Temperature Range													
Specified Value	-40~+85°C												
Test Methods and Remarks	-5 to 40°C for the product with taping.												
3. Rated current													
Specified Value	Within the specified tolerance												
4. Inductance													
Specified Value	Within the specified tolerance												
Test Methods and Remarks	Measuring equipment : LCR Meter (HP 4285A or equivalent) Measuring frequency : 100kHz, 1V												
5. DC Resistance													
Specified Value	Within the specified tolerance												
Test Methods and Remarks	Measuring equipment : DC ohmmeter (HIOKI 3227 or equivalent)												
6. Self resonance frequency													
Specified Value	Within the specified tolerance (2020 type: -)												
Test Methods and Remarks	Measuring equipment : Impedance analyzer/material analyzer (HP4291A or equivalent HP4191A, 4192A or equivalent)												
7. Temperature characteristic													
Specified Value	Inductance change : Within $\pm 20\%$												
Test Methods and Remarks	<p>Measurement of inductance shall be taken at temperature range within <math>-40^{\circ}\text{C}\sim +85^{\circ}\text{C}</math>.            With reference to inductance value at <math>+20^{\circ}\text{C}</math>., change rate shall be calculated.            Change of maximum inductance deviation in step 1 to 5</p> <table border="1"> <thead> <tr> <th>Step</th> <th>Temperature (°C)</th> </tr> </thead> <tbody> <tr> <td>1</td> <td>20</td> </tr> <tr> <td>2</td> <td>Minimum operating temperature</td> </tr> <tr> <td>3</td> <td>20 (Standard temperature)</td> </tr> <tr> <td>4</td> <td>Maximum operating temperature</td> </tr> <tr> <td>5</td> <td>20</td> </tr> </tbody> </table>	Step	Temperature (°C)	1	20	2	Minimum operating temperature	3	20 (Standard temperature)	4	Maximum operating temperature	5	20
Step	Temperature (°C)												
1	20												
2	Minimum operating temperature												
3	20 (Standard temperature)												
4	Maximum operating temperature												
5	20												

► This catalog contains the typical specification only due to the limitation of space. When you consider the purchase of our products, please check our specification.  
 For details of each product (characteristics graph, reliability information, precautions for use, and so on), see our Web site (<http://www.ty-top.com/>).



#### 14. Solderability

Specified Value	At least 90% of surface of terminal electrode is covered by new solder.	
Test Methods and Remarks	The test samples shall be dipped in flux, and then immersed in molten solder as shown in below table. Flux : Ethanol solution containing rosin 25%.	
	Solder Temperature	245±5°C
	Time	5±1.0 sec.
※Immersion depth : All sides of mounting terminal shall be immersed.		

#### 15. Resistance to soldering heat

Specified Value	Inductance change : Within ±10% No significant abnormality in appearance.	
Test Methods and Remarks	The test sample shall be exposed to reflow oven at 230±5°C for 40 seconds, with peak temperature at 260±5°C for 5 seconds, 2 times.	
	Test board material	: glass epoxy-resin
	Test board thickness	: 1.0mm

#### 16. Thermal shock

Specified Value	Inductance change : Within ±10% No significant abnormality in appearance.		
Test Methods and Remarks	The test samples shall be soldered to the test board by the reflow. The test samples shall be placed at specified temperature for specified time by step 1 to step 4 as shown in below table in sequence. The temperature cycle shall be repeated 1000 cycles.		
	Conditions of 1 cycle		
	Step	Temperature (°C)	Duration (min)
	1	-40±3	30±3
	2	Room temperature	Within 3
	3	+85±2	30±3
4	Room temperature	Within 3	

#### 17. Damp heat

Specified Value	Inductance change : Within ±10% No significant abnormality in appearance.	
Test Methods and Remarks	The test samples shall be soldered to the test board by the reflow.	
	The test samples shall be placed in thermostatic oven set at specified temperature and humidity as shown in below table.	
	Temperature	60±2°C
	Humidity	90~95%RH
	Time	1000+24/-0 hour

#### 18. Loading under damp heat

Specified Value	Inductance change : Within ±10% No significant abnormality in appearance.	
Test Methods and Remarks	The test samples shall be soldered to the test board by the reflow.	
	The test samples shall be placed in thermostatic oven set at specified temperature and humidity and applied the rated current continuously as shown in below table.	
	Temperature	60±2°C
	Humidity	90~95%RH
	Applied current	Rated current
	Time	1000+24/-0 hour

#### 19. Low temperature life test

Specified Value	Inductance change : Within ±10% No significant abnormality in appearance.	
Test Methods and Remarks	The test samples shall be soldered to the test board by the reflow. After that, the test samples shall be placed at test conditions as shown in below table.	
	Temperature	-40±2°C
	Time	1000+24/-0 hour

#### 20. High temperature life test

Specified Value	—
-----------------	---

▶ This catalog contains the typical specification only due to the limitation of space. When you consider the purchase of our products, please check our specification. For details of each product (characteristics graph, reliability information, precautions for use, and so on), see our Web site (<http://www.ty-top.com/>).

21. Loading at high temperature life test

Specified Value	Inductance change : Within $\pm 10\%$ No significant abnormality in appearance.	
Test Methods and Remarks	The test samples shall be soldered to the test board by the reflow soldering.	
	Temperature	$85 \pm 2^\circ\text{C}$
	Applied current	Rated current
	Time	$1000 + 24 / - 0$ hour

22. Standard condition

Specified Value	Standard test condition : Unless otherwise specified, temperature is $20 \pm 15^\circ\text{C}$ and $65 \pm 20\%$ of relative humidity. When there is any question concerning measurement result: In order to provide correlation data, the test shall be condition of $20 \pm 2^\circ\text{C}$ of temperature, $65 \pm 5\%$ relative humidity. Inductance is in accordance with our measured value.
-----------------	--

Wire-wound Ferrite Power Inductors LAYP series for Automotive Powertrain and safety  
 Wire-wound Ferrite Power Inductors LCXN/LCXP series for Automotive Body & Chassis and Infotainment  
 Wire-wound Ferrite Power Inductors LCXH series for Automotive Body & Chassis and Infotainment  
 Wire-wound Ferrite Inductors for Class D Amplifier LCXA for Automotive Body & Chassis and Infotainment  
 Wire-wound Ferrite Power Inductors LCRN series for Automotive Body & Chassis and Infotainment  
 Wire-wound Ferrite Power Inductors LBXN/LBXP series  
 for Telecommunications Infrastructure and Industrial Equipment  
 Wire-wound Ferrite Power Inductors LBXH series  
 for Telecommunications Infrastructure and Industrial Equipment  
 Wire-wound Ferrite Power Inductors LBRN series  
 for Telecommunications Infrastructure and Industrial Equipment  
 Wire-wound Ferrite Power Inductors LMXN/LMXP series  
 for Medical Devices classified as GHTF Class C (Japan Class III)  
 Wire-wound Ferrite Power Inductors LMXH series  
 for Medical Devices classified as GHTF Class C (Japan Class III)  
 Wire-wound Ferrite Power Inductors LMRN series  
 for Medical Devices classified as GHTF Class C (Japan Class III)

■ PRECAUTIONS

1. Circuit Design	
Precautions	<ul style="list-style-type: none"> <li>◆ Verification of operating environment, electrical rating and performance               <ol style="list-style-type: none"> <li>1. A malfunction in medical equipment, spacecraft, nuclear reactors, etc. may cause serious harm to human life or have severe social ramifications. As such, any inductors to be used in such equipment may require higher safety and/or reliability considerations and should be clearly differentiated from components used in general purpose applications.</li> <li>2. When inductors are used in places where dew condensation develops and/or where corrosive gas such as hydrogen sulfide, sulfurous acid, or chlorine exists in the air, characteristic deterioration may occur. Please do not use inductors under such environmental conditions.</li> </ol> </li> <li>◆ Operating Current (Verification of Rated current)               <ol style="list-style-type: none"> <li>1. The operating current including inrush current for inductors must always be lower than their rated values.</li> <li>2. Do not apply current in excess of the rated value because the inductance may be reduced due to the magnetic saturation effect.</li> </ol> </li> <li>◆ Temperature rise               <p>Temperature rise of power choke coil depends on the installation condition in end products.                Make sure that temperature rise of power choke coils in actual end products is within the specified temperature range.</p> </li> </ul>
2. PCB Design	
Precautions	<ul style="list-style-type: none"> <li>◆ Land pattern design               <ol style="list-style-type: none"> <li>1. Please refer to a recommended land pattern.</li> <li>2. There is stress, which has been caused by distortion of a PCB, to the inductor. (LCXN/LCXP/LBXN/LBXP/LMXN/LMXP, LCXH/LCXA/LBXH/LMXH)</li> <li>3. Please consider the arrangement of parts on a PCB. (LCXN/LCXP/LBXN/LBXP/LMXN/LMXP, LCXH/LCXA/LBXH/LMXH)</li> </ol> </li> </ul>
Technical considerations	<ul style="list-style-type: none"> <li>◆ Land pattern design               <p>Surface Mounting</p> <ol style="list-style-type: none"> <li>1. Mounting and soldering conditions should be checked beforehand.</li> <li>2. Applicable soldering process to this products is reflow soldering only.</li> <li>3. Please use the recommended land pattern shown as below. Electrical characteristics and the mounting ability of the product are being considered in the after recommended land pattern. If a PCB is designed with other dimensions, defective soldering and stress to a product may occur due to misalignment. The performance of the product may not be brought out. If an adopted land pattern is different from the recommended land pattern, stress to the product will increase. It may cause cracks or defective electrical characteristics of the product. Please conduct validation completely before studying adoption of this product and please judge the pros and cons of adoption of this product with taking on responsibility. (LCXN/LCXP/LBXN/LBXP/LMXN/LMXP, LCXH/LCXA/LBXH/LMXH)</li> <li>4. As coefficients of thermal expansion between an inductor and a PCB differs, cracks may occur on a ferrite core when thermal stress is applied to them after mounting an inductor. (Please refer to the drawings below.) Please conduct validation completely before studying adoption of this product and please judge the pros and cons of adoption of this product with taking on responsibility. (LCXN/LCXP/LBXN/LBXP/LMXN/LMXP, LCXH/LCXA/LBXH/LMXH)</li> </ol> </li> </ul>

▶ This catalog contains the typical specification only due to the limitation of space. When you consider the purchase of our products, please check our specification.  
 For details of each product (characteristics graph, reliability information, precautions for use, and so on), see our Web site (<http://www.ty-top.com/>)

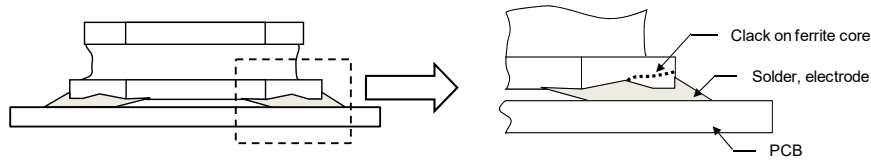

5. SMD inductors should be located to minimize any possible mechanical stresses from board warp or deflection. When splitting the PC board after mounting inductors and other components, care is required so as not to give any stresses of deflection or twisting to the board.  
(LCXN/LCXP/LBXN/LBXP/LMXN/LMXP, LCXH/LCXA/LBXH/LMXH)

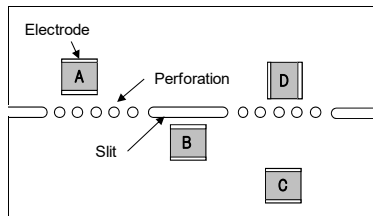

A product tends to undergo stress in order "A>C>B≡D".  
Please consider the layouts of a product to minimize any stresses.

### 3. Considerations for automatic placement

Precautions	<ul style="list-style-type: none"> <li>◆ Adjustment of mounting machine</li> <li>1. Excessive impact load should not be imposed on the products when mounting onto the PC boards.</li> <li>2. Mounting and soldering conditions should be checked beforehand.</li> </ul>
Technical considerations	<ul style="list-style-type: none"> <li>◆ Adjustment of mounting machine</li> <li>1. When installing products, care should be taken not to apply distortion stress as it may deform the products.</li> <li>2. Stress may be applied to a product with a warp or a twist in handling of the product. Please conduct validation completely before studying adoption of this product and please judge the pros and cons of adoption of this product with taking on responsibility. (LCXN/LCXP/LBXN/LBXP/LMXN/LMXP, LCXH/LCXA/LBXH/LMXH)</li> </ul> <div style="display: flex; justify-content: space-around; align-items: center;"> <div style="text-align: center;"> <p>&lt;Wrap&gt;</p> </div> <div style="text-align: center;"> <p>&lt;Twist&gt;</p> </div> </div>

### 4. Soldering

Precautions	<ul style="list-style-type: none"> <li>◆ Reflow soldering</li> <li>1. Please contact any of our offices for a reflow soldering, and refer to the recommended condition specified.</li> <li>2. The product shall be used reflow soldering only.</li> <li>3. Please do not add any stress to a product until it returns in normal temperature after reflow soldering.</li> <li>◆ Lead free soldering</li> <li>1. When using products with lead free soldering, we request to use them after confirming adhesion, temperature of resistance to soldering heat, soldering etc sufficiently.</li> <li>◆ Recommended conditions for using a soldering iron</li> <ul style="list-style-type: none"> <li>• Put the soldering iron on the land-pattern.</li> <li>• Soldering iron's temperature - Below 350°C</li> <li>• Duration - 3 seconds or less</li> <li>• The soldering iron should not directly touch the inductor.</li> </ul> </ul>
Technical considerations	<ul style="list-style-type: none"> <li>◆ Reflow soldering</li> <li>1. If products are used beyond the range of the recommended conditions, heat stresses may deform the products, and consequently degrade the reliability of the products.</li> </ul> <p style="text-align: center;">Recommended reflow condition (Pb free solder)</p> <p style="text-align: center;"><u>LCXN/LCXP/LBXN/LBXP/LMXN/LMXP,</u> <u>LCXH/LCXA/LBXH/LMXH, LCRN/LBRN/LMRN</u></p> <div style="display: flex; justify-content: space-around;"> <div style="text-align: center;"> </div> <div style="text-align: center;"> </div> </div>

▶ This catalog contains the typical specification only due to the limitation of space. When you consider the purchase of our products, please check our specification.  
For details of each product (characteristics graph, reliability information, precautions for use, and so on), see our Web site (<http://www.ty-top.com/>)



5. Cleaning	
Precautions	<ul style="list-style-type: none"> <li>◆ Cleaning conditions               <ol style="list-style-type: none"> <li>1. Washing by supersonic waves shall be avoided.</li> </ol> </li> </ul>
Technical considerations	<ul style="list-style-type: none"> <li>◆ Cleaning conditions               <ol style="list-style-type: none"> <li>1. If washed by supersonic waves, the products might be broken.</li> </ol> </li> </ul>
6. Handling	
Precautions	<ul style="list-style-type: none"> <li>◆ Handling               <ol style="list-style-type: none"> <li>1. Keep the product away from all magnets and magnetic objects.</li> </ol> </li> <li>◆ Breakaway PC boards (splitting along perforations)               <ol style="list-style-type: none"> <li>1. When splitting the PC board after mounting product, care should be taken not to give any stresses of deflection or twisting to the board.</li> <li>2. Board separation should not be done manually, but by using the appropriate devices.</li> </ol> </li> <li>◆ Mechanical considerations               <ol style="list-style-type: none"> <li>1. Please do not give the product any excessive mechanical shocks.</li> <li>2. Please do not add any shock and power to a product in transportation.</li> </ol> </li> <li>◆ Pick-up pressure               <ol style="list-style-type: none"> <li>1. Please do not push to add any pressure to a winding part. Please do not give any shock and push into a ferrite core exposure part.</li> </ol> </li> <li>◆ Packing               <ol style="list-style-type: none"> <li>1. Please avoid accumulation of a packing box as much as possible.</li> </ol> </li> </ul>
Technical considerations	<ul style="list-style-type: none"> <li>◆ Handling               <ol style="list-style-type: none"> <li>1. There is a case that a characteristic varies with magnetic influence.</li> </ol> </li> <li>◆ Breakaway PC boards (splitting along perforations)               <ol style="list-style-type: none"> <li>1. The position of the product on PCBs shall be carefully considered to minimize the stress caused from splitting of the PCBs.</li> </ol> </li> <li>◆ Mechanical considerations               <ol style="list-style-type: none"> <li>1. There is a case to be damaged by a mechanical shock.</li> <li>2. There is a case to be broken by the handling in transportation.</li> </ol> </li> <li>◆ Pick-up pressure               <ol style="list-style-type: none"> <li>1. Damage and a characteristic can vary with an excessive shock or stress.</li> </ol> </li> <li>◆ Packing               <ol style="list-style-type: none"> <li>1. If packing boxes are accumulated, that could cause a deformation on packing tapes or a damage on the products.</li> </ol> </li> </ul>
7. Storage conditions	
Precautions	<ul style="list-style-type: none"> <li>◆ Storage               <ol style="list-style-type: none"> <li>1. To maintain the solderability of terminal electrodes and to keep the packing material in good condition, temperature and humidity in the storage area should be controlled.                   <ul style="list-style-type: none"> <li>▪ Recommended conditions                       <ul style="list-style-type: none"> <li>Ambient temperature : <math>-5\sim 40^{\circ}\text{C}</math></li> <li>Humidity : Below 70% RH</li> </ul> </li> <li>▪ The ambient temperature must be kept below <math>30^{\circ}\text{C}</math>. Even under ideal storage conditions, solderability of products electrodes may decrease as time passes.                           <ul style="list-style-type: none"> <li>For this reason, product should be used within 6 months from the time of delivery.</li> <li>In case of storage over 6 months, solderability shall be checked before actual usage.</li> </ul> </li> </ul> </li> </ol> </li> </ul>
Technical considerations	<ul style="list-style-type: none"> <li>◆ Storage               <ol style="list-style-type: none"> <li>1. Under a high temperature and humidity environment, problems such as reduced solderability caused by oxidation of terminal electrodes and deterioration of taping/packaging materials may take place.</li> </ol> </li> </ul>

## X-ON Electronics

Largest Supplier of Electrical and Electronic Components

*Click to view similar products for [Power Inductors - SMD category](#):*

*Click to view products by [Taiyo Yuden manufacturer](#):*

Other Similar products are found below :

[IHL1616BZRZR10ML1](#) [PID75-251M](#) [78404054015](#) [78404064220](#) [PID75-560M](#) [78404064015](#) [78404064100](#) [78404064470](#) [78404064101](#)  
[PID75-650M](#) [SPB1007-R22M](#) [SRR1050HA-680Y](#) [SPB1005-R10M](#) [SPB1007-R23M](#) [SRR1050HA-180Y](#) [SRR1050HA-270Y](#) [SRR1050HA-](#)  
[R68Y](#) [SPB1012-R15Y](#) [SPB1007-R17M](#) [SRP2512TMA-1R5M](#) [SRR1050HA-471Y](#) [SRP2512TMA-R47M](#) [SRR1050HA-470Y](#) [SRR1050HA-](#)  
[1R2Y](#) [SPB1005-R15M](#) [SPB1005-R12M](#) [SPB1012-R13Y](#) [SPB1308-R44M](#) [SRP2510TMA-R22M](#) [SPB0705-R12M](#) [SRP2510TMA-2R2M](#)  
[SRP2010TMA-R24M](#) [SRP2012TMA-R47M](#) [SRR1050HA-8R2Y](#) [SRR1050HA-101Y](#) [SRP2510TMA-R33M](#) [SRR1050HA-390Y](#)  
[SRR1050HA-3R3Y](#) [SRP2512TMA-R68M](#) [SRP2012TMA-1R0M](#) [SRP2012TMA-1R5M](#) [SRR1050HA-151Y](#) [SRR1050HA-560Y](#)  
[SRR1050HA-100Y](#) [SRP2012TMA-R68M](#) [SRP2510TMA-R47M](#) [SRP2512TMA-R33M](#) [SRR1050HA-220Y](#) [SPB0705-R10M](#) [SRP2010TMA-](#)  
[R56M](#)