

Notice for TAIYO YUDEN Products

Please read this notice before using the TAIYO YUDEN products.

⚠ REMINDERS

Product Information in this Catalog

Product information in this catalog is as of March 2023. All of the contents specified herein and production status of the products listed in this catalog are subject to change without notice due to technical improvement of our products, etc. Therefore, please check for the latest information carefully before practical application or use of our products.

Please note that TAIYO YUDEN shall not be in any way responsible for any damages and defects in products or equipment incorporating our products, which are caused under the conditions other than those specified in this catalog or individual product specification sheets.

Approval of Product Specifications

Please contact TAIYO YUDEN for further details of product specifications as the individual product specification sheets are available. When using our products, please be sure to approve our product specifications or make a written agreement on the product specification with TAIYO YUDEN in advance.

Pre-Evaluation in the Actual Equipment and Conditions

Please conduct validation and verification of our products in actual conditions of mounting and operating environment before using our products.

Limited Application

1. Equipment Intended for Use

The products listed in this catalog are intended for general-purpose and standard use in general electronic equipment for consumer (e.g., AV equipment, OA equipment, home electric appliances, office equipment, information and communication equipment including, without limitation, mobile phone, and PC) and other equipment specified in this catalog or the individual product specification sheets, or the equipment approved separately by TAIYO YUDEN.

TAIYO YUDEN has the product series intended for use in the following equipment. Therefore, when using our products for these equipment, please check available applications specified in this catalog or the individual product specification sheets and use the corresponding products.

| Application | Product Series | | Quality Grade ^{*3} |
|-------------|--|---|-----------------------------|
| | Equipment ^{*1} | Category (Part Number Code ^{*2}) | |
| Automotive | Automotive Electronic Equipment (POWERTRAIN, SAFETY) | A | 1 |
| | Automotive Electronic Equipment (BODY & CHASSIS, INFOTAINMENT) | C | 2 |
| Industrial | Telecommunications Infrastructure and Industrial Equipment | B | 2 |
| Medical | Medical Devices classified as GHTF Class C (Japan Class III) | M | 2 |
| | Medical Devices classified as GHTF Classes A or B (Japan Classes I or II) | L | 3 |
| Consumer | General Electronic Equipment | S | 3 |
| | Only for Mobile Devices ^{*4} | E | 4 |

*Notes: 1. Based on the general specifications required for electronic components for such equipment, which are recognized by TAIYO YUDEN, the use of each product series for the equipment is recommended. Please be sure to contact TAIYO YUDEN before using our products for equipment other than those covered by the product series.

2. On each of our part number, the 2nd code from the left is a code indicating the "Category" as shown in the above table. For details, please check the explanatory materials regarding the part numbering system of each of our products.

3. Each product series is assigned a "Quality Grade" from 1 to 4 in order of higher quality. Please do not incorporate a product into any equipment with a higher Quality Grade than the Quality Grade of such product without the prior written consent of TAIYO YUDEN.

4. The applications covered by this product series are limited to mobile devices (smartphone, tablet PC, smartwatch, handheld game console, etc.) among general electronic equipment for consumer. The design, specifications and operating environment, etc. differ from those of the product series for "General Electronic Equipment" (Category: S), so please check the individual product specification sheets for details. The product series for "General Electronic Equipment" (Category: S) can also be used for mobile devices.

▶ This catalog contains the typical specification only due to the limitation of space. When you consider the purchase of our products, please check our product specification sheets. For details of each product (characteristics graph, reliability information, precautions for use, and so on), see our website (<http://www.ty-top.com/>).

2. Equipment Requiring Inquiry

Please be sure to contact TAIYO YUDEN for further information before using the products listed in this catalog for the following equipment (excluding intended equipment as specified in this catalog or the individual product specification sheets) which may cause loss of human life, bodily injury, serious property damage and/or serious public impact due to a failure or defect of the products and/or malfunction attributed thereto.

- (1) Transportation equipment (automotive powertrain control system, train control system, and ship control system, etc.)
- (2) Traffic signal equipment
- (3) Disaster prevention equipment, crime prevention equipment
- (4) Medical devices classified as GHTF Class C (Japan Class III)
- (5) Highly public information network equipment, data-processing equipment (telephone exchange, and base station, etc.)
- (6) Any other equipment requiring high levels of quality and/or reliability equal to the equipment listed above

3. Equipment Prohibited for Use

Please do not incorporate our products into the following equipment requiring extremely high levels of safety and/or reliability.

- (1) Aerospace equipment (artificial satellite, rocket, etc.)
- (2) Aviation equipment *1
- (3) Medical devices classified as GHTF Class D (Japan Class IV), implantable medical devices *2
- (4) Power generation control equipment (nuclear power, hydroelectric power, thermal power plant control system, etc.)
- (5) Undersea equipment (submarine repeating equipment, etc.)
- (6) Military equipment
- (7) Any other equipment requiring extremely high levels of safety and/or reliability equal to the equipment listed above

*Notes: 1. There is a possibility that our products can be used only for aviation equipment that does not directly affect the safe operation of aircraft (e.g., in-flight entertainment, cabin light, electric seat, cooking equipment) if such use meets requirements specified separately by TAIYO YUDEN. Please be sure to contact TAIYO YUDEN for further information before using our products for such aviation equipment.

2. Implantable medical devices contain not only internal unit which is implanted in a body, but also external unit which is connected to the internal unit.

4. Limitation of Liability

Please note that unless you obtain prior written consent of TAIYO YUDEN, TAIYO YUDEN shall not be in any way responsible for any damages incurred by you or third parties arising from use of the products listed in this catalog for any equipment that is not intended for use by TAIYO YUDEN, or any equipment requiring inquiry to TAIYO YUDEN or prohibited for use by TAIYO YUDEN as described above.

■ Safety Design

When using our products for high safety and/or reliability-required equipment or circuits, please fully perform safety and/or reliability evaluation. In addition, please install (i) systems equipped with a protection circuit and a protection device and/or (ii) systems equipped with a redundant circuit or other system to prevent an unsafe status in the event of a single fault for a failsafe design to ensure safety.

■ Intellectual Property Rights

Information contained in this catalog is intended to convey examples of typical performances and/or applications of our products and is not intended to make any warranty with respect to the intellectual property rights or any other related rights of TAIYO YUDEN or any third parties nor grant any license under such rights.

■ Limited Warranty

Please note that the scope of warranty for our products is limited to the delivered our products themselves conforming to the product specifications specified in the individual product specification sheets, and TAIYO YUDEN shall not be in any way responsible for any damages resulting from a failure or defect in our products. Notwithstanding the foregoing, if there is a written agreement (e.g., supply and purchase agreement, quality assurance agreement) signed by TAIYO YUDEN and your company, TAIYO YUDEN will warrant our products in accordance with such agreement, provided, however, that our products shall be used for general-purpose and standard use in the equipment specified in this catalog or the individual product specification sheets.

■ TAIYO YUDEN's Official Sales Channel

The contents of this catalog are applicable to our products which are purchased from our sales offices or authorized distributors (hereinafter "TAIYO YUDEN's official sales channel"). Please note that the contents of this catalog are not applicable to our products purchased from any seller other than TAIYO YUDEN's official sales channel.

■ Caution for Export

Some of our products listed in this catalog may require specific procedures for export according to "U.S. Export Administration Regulations", "Foreign Exchange and Foreign Trade Control Law" of Japan, and other applicable regulations. Should you have any questions on this matter, please contact our sales staff.

▶ This catalog contains the typical specification only due to the limitation of space. When you consider the purchase of our products, please check our product specification sheets. For details of each product (characteristics graph, reliability information, precautions for use, and so on), see our website (<http://www.ty-top.com/>).

Wire-wound Metal Power Inductors MCOIL™ LSEU series for General Electronic Equipment for Consumer

Code in front of Series have been extracted from Part number, which describes the segment of products, such as kinds and characteristics.

REFLOW

PART NUMBER

* Operating Temp.: -40~+125°C (Including self-generated heat)

| | | | | | | | | | | | | | | | | |
|---|---|---|---|---|---|---|---|---|---|---|---|---|---|---|---|--|
| L | S | E | U | C | 2 | 0 | 1 | 6 | K | K | T | 1 | R | 0 | M | |
| ① | ② | ③ | ④ | ⑤ | ⑥ | ⑦ | ⑧ | | | | | | | | | |

① Series

| Code (1)(2)(3)(4) | |
|----------------------|---|
| LSEU | Wire-wound Metal Power Inductor for General Electronic Equipment for Consumer |

(1) Product Group

| Code | |
|------|-----------|
| L | Inductors |

(2) Category

| Code | Recommended equipment | Quality Grade |
|------|---|---------------|
| S | General Electronic Equipment for Consumer | 3 |

② Features

| Code | Feature |
|------|--|
| C | Bottom electrode (Ag-resin × Sn-plate) |

③ Dimensions (L × W)

| Code | Dimensions (L × W) [mm] |
|------|-------------------------|
| 2012 | 2.0 × 1.25 |
| 2016 | 2.0 × 1.6 |
| 2520 | 2.5 × 2.0 |
| 3225 | 3.2 × 2.5 |

④ Dimensions (T)

| Code | Dimensions (T) [mm] |
|------|---------------------|
| HK | 0.8 |
| KK | 1.0 |

(3) Type

| Code | |
|------|--------------------------------------|
| E | Metal Wire-wound (High filling type) |

(4) Features, Characteristics

| Code | |
|------|---------------------------|
| U | High strength power choke |

⑤ Packaging

| Code | Packaging |
|------|-----------|
| T | Taping |

⑥ Nominal inductance

| Code (example) | Nominal inductance [μH] |
|-------------------|-------------------------|
| R47 | 0.47 |
| 1R0 | 1.0 |
| 4R7 | 4.7 |

※R=Decimal point

⑦ Inductance tolerance

| Code | Inductance tolerance |
|------|----------------------|
| M | ±20% |

⑧ Internal code

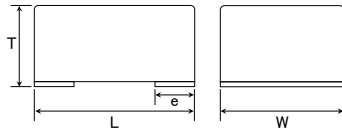
STANDARD EXTERNAL DIMENSIONS / STANDARD QUANTITY

Recommended Land Patterns
Surface Mounting

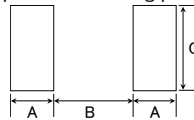
- Mounting and soldering conditions should be checked beforehand.
- Applicable soldering process to these products is reflow soldering only.



| Type | A | B | C |
|------|-----|-----|-----|
| 2012 | 0.8 | 0.6 | 1.4 |
| 2016 | 0.8 | 0.6 | 1.8 |
| 2520 | 1.0 | 0.8 | 2.2 |
| 3225 | 1.1 | 1.3 | 2.7 |

Unit : mm

| Type | L | W | T | e | Standard quantity [pcs] Taping |
|--------|--------------------------|--------------------------|------------------------|--------------------------|-----------------------------------|
| 2012HK | 2.0±0.2 (0.079±0.008) | 1.2±0.2 (0.047±0.008) | 0.8 max (0.031 max) | 0.6±0.3 (0.024±0.012) | 3000 |
| 2012KK | 2.0±0.2 (0.079±0.008) | 1.2±0.2 (0.047±0.008) | 1.0 max (0.039 max) | 0.6±0.3 (0.024±0.012) | 3000 |
| 2016HK | 2.0±0.2 (0.079±0.008) | 1.6±0.2 (0.063±0.008) | 0.8 max (0.031 max) | 0.6±0.3 (0.024±0.012) | 3000 |
| 2016KK | 2.0±0.2 (0.079±0.008) | 1.6±0.2 (0.063±0.008) | 1.0 max (0.039 max) | 0.6±0.3 (0.024±0.012) | 3000 |
| 2520KK | 2.5±0.2 (0.098±0.008) | 2.0±0.2 (0.079±0.008) | 1.0 max (0.039 max) | 0.8±0.3 (0.031±0.012) | 3000 |
| 3225HK | 3.2±0.2 (0.126±0.008) | 2.5±0.2 (0.098±0.008) | 0.8 max (0.031 max) | 1.0±0.3 (0.039±0.012) | 3000 |

Unit : mm (inch)

PART NUMBER

● 2012HK type 【Thickness: 0.8mm max.】

| New part number | Old part number (for reference) | EHS | Nominal inductance [μ H] | Inductance tolerance | Self-resonant frequency [MHz] (min.) | DC Resistance [Ω] (max.) | Rated current ※) [mA] (max.) | | Measuring frequency [MHz] |
|------------------|------------------------------------|------|----------------------------------|----------------------|--|--------------------------------------|------------------------------|----------------------------------|------------------------------|
| | | | | | | | Saturation current Idc1 | Temperature rise current Idc2 | |
| LSEUC2012HKTR47M | MEHK2012UR47M | RoHS | 0.47 | $\pm 20\%$ | - | 0.033 | 4,500 | 3,800 | 1 |

● 2012KK type 【Thickness: 1.0mm max.】

| New part number | Old part number (for reference) | EHS | Nominal inductance [μ H] | Inductance tolerance | Self-resonant frequency [MHz] (min.) | DC Resistance [Ω] (max.) | Rated current ※) [mA] (max.) | | Measuring frequency [MHz] |
|------------------|------------------------------------|------|----------------------------------|----------------------|--|--------------------------------------|------------------------------|----------------------------------|------------------------------|
| | | | | | | | Saturation current Idc1 | Temperature rise current Idc2 | |
| LSEUC2012KKTR33M | MEKK2012UR33M | RoHS | 0.33 | $\pm 20\%$ | - | 0.024 | 5,800 | 4,600 | 1 |
| LSEUC2012KKTR47M | MEKK2012UR47M | RoHS | 0.47 | $\pm 20\%$ | - | 0.027 | 5,000 | 4,300 | 1 |

● 2016HK type 【Thickness: 0.8mm max.】

| New part number | Old part number (for reference) | EHS | Nominal inductance [μ H] | Inductance tolerance | Self-resonant frequency [MHz] (min.) | DC Resistance [Ω] (max.) | Rated current ※) [mA] (max.) | | Measuring frequency [MHz] |
|-------------------|------------------------------------|------|----------------------------------|----------------------|--|--------------------------------------|------------------------------|----------------------------------|------------------------------|
| | | | | | | | Saturation current Idc1 | Temperature rise current Idc2 | |
| LSEUC2016HKTR47M | MEHK2016UR47M | RoHS | 0.47 | $\pm 20\%$ | - | 0.028 | 4,900 | 4,200 | 1 |
| LSEUC2016HKTR1R0M | MEHK2016U1R0M | RoHS | 1.0 | $\pm 20\%$ | - | 0.050 | 3,200 | 3,000 | 1 |

● 2016KK type 【Thickness: 1.0mm max.】

| New part number | Old part number (for reference) | EHS | Nominal inductance [μ H] | Inductance tolerance | Self-resonant frequency [MHz] (min.) | DC Resistance [Ω] (max.) | Rated current ※) [mA] (max.) | | Measuring frequency [MHz] |
|-------------------|------------------------------------|------|----------------------------------|----------------------|--|--------------------------------------|------------------------------|----------------------------------|------------------------------|
| | | | | | | | Saturation current Idc1 | Temperature rise current Idc2 | |
| LSEUC2016KKTR47M | MEKK2016UR47M | RoHS | 0.47 | $\pm 20\%$ | - | 0.026 | 6,300 | 4,700 | 1 |
| LSEUC2016KKTR1R0M | MEKK2016U1R0M | RoHS | 1.0 | $\pm 20\%$ | - | 0.048 | 4,100 | 3,500 | 1 |

● 2520KK type 【Thickness: 1.0mm max.】

| New part number | Old part number (for reference) | EHS | Nominal inductance [μ H] | Inductance tolerance | Self-resonant frequency [MHz] (min.) | DC Resistance [Ω] (max.) | Rated current ※) [mA] (max.) | | Measuring frequency [MHz] |
|------------------|------------------------------------|------|----------------------------------|----------------------|--|--------------------------------------|------------------------------|----------------------------------|------------------------------|
| | | | | | | | Saturation current Idc1 | Temperature rise current Idc2 | |
| LSEUC2520KKT1R0M | MEKK2520U1R0M | RoHS | 1.0 | $\pm 20\%$ | - | 0.037 | 4,400 | 3,600 | 1 |
| LSEUC2520KKT2R2M | MEKK2520U2R2M | RoHS | 2.2 | $\pm 20\%$ | - | 0.076 | 3,000 | 2,500 | 1 |
| LSEUC2520KKT4R7M | MEKK2520U4R7M | RoHS | 4.7 | $\pm 20\%$ | - | 0.160 | 2,200 | 1,800 | 1 |
| LSEUC2520KKT6R8M | MEKK2520U6R8M | RoHS | 6.8 | $\pm 20\%$ | - | 0.265 | 1,200 | 1,300 | 1 |
| LSEUC2520KKT100M | MEKK2520U100M | RoHS | 10 | $\pm 20\%$ | - | 0.432 | 1,000 | 1,000 | 1 |

● 3225HK type 【Thickness: 0.8mm max.】

| New part number | Old part number (for reference) | EHS | Nominal inductance [μ H] | Inductance tolerance | Self-resonant frequency [MHz] (min.) | DC Resistance [Ω] (max.) | Rated current ※) [mA] (max.) | | Measuring frequency [MHz] |
|------------------|------------------------------------|------|----------------------------------|----------------------|--|--------------------------------------|------------------------------|----------------------------------|------------------------------|
| | | | | | | | Saturation current Idc1 | Temperature rise current Idc2 | |
| LSEUC3225HKT1R0M | MEHK3225U1R0M | RoHS | 1.0 | $\pm 20\%$ | - | 0.043 | 5,200 | 4,200 | 1 |

※) The saturation current value (Idc1) is the DC current value having inductance decrease down to 30%. (at 20°C)

※) The temperature rise current value (Idc2) is the DC current value having temperature increase up to 40°C. (at 20°C)

※) The rated current is the DC current value that satisfies both of current value saturation current value and temperature rise current value.

※) Idc2 Measurement board data

Material:FR4

Board dimensions: 100 × 50 × 1.6t mm

Pattern dimensions: 45 × 45 mm (Double side board)

Pattern thickness: 70 μ m

Wire-wound Metal Power Inductors MCOIL™ LSEN/LLEN/LCEN/LBEN/LMEN series

Wire-wound Metal Power Inductors MCOIL™ LSEP/LLEP series

Wire-wound Metal Power Inductors MCOIL™ LSEU/LLEU series

PACKAGING

① Minimum Quantity

| Type | Standard Quantity [pcs] |
|--------|-------------------------|
| | Tape & Reel |
| 2012HK | 3000 |
| 2012KK | 3000 |
| 2016MK | 3000 |
| 2016HK | 3000 |
| 2016KK | 3000 |
| 2520KK | 3000 |
| 2520MK | 3000 |
| 3225HK | 3000 |

② Tape Material

● Embossed Tape

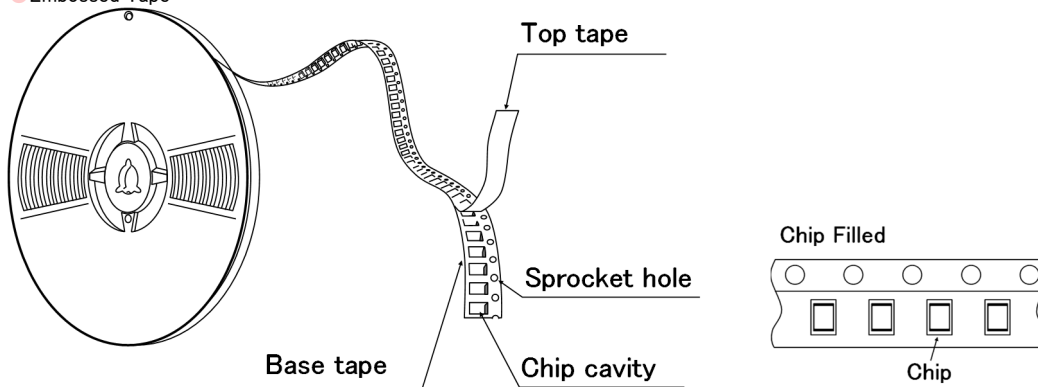

③ Taping dimensions

● Embossed tape 8mm wide (0.315 inches wide)

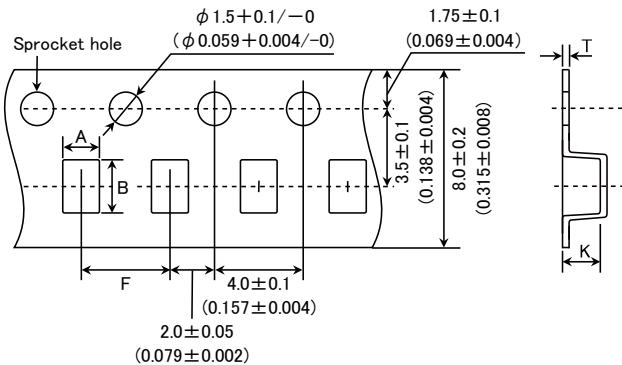

| Type | Chip cavity | | Insertion pitch | Tape thickness | |
|--------|---|---|--|--|---|
| | A | B | F | T | K |
| 2012HK | 1.45 ± 0.1 (0.057 ± 0.004) | 2.25 ± 0.1 (0.089 ± 0.004) | 4.0 ± 0.1 (0.157 ± 0.004) | 0.25 ± 0.05 (0.009 ± 0.002) | $0.9 + 0.15 / -0.1$ ($0.035 + 0.006 / -0.004$) |
| 2012KK | 1.45 ± 0.1 (0.057 ± 0.004) | 2.25 ± 0.1 (0.089 ± 0.004) | 4.0 ± 0.1 (0.157 ± 0.004) | 0.25 ± 0.05 (0.009 ± 0.002) | 1.1 ± 0.1 (0.043 ± 0.004) |
| 2016MK | 1.9 ± 0.1 (0.075 ± 0.004) | 2.45 ± 0.1 (0.097 ± 0.004) | 4.0 ± 0.1 (0.157 ± 0.004) | 0.25 ± 0.05 (0.009 ± 0.002) | 1.4 ± 0.1 (0.055 ± 0.004) |
| 2016HK | 1.9 ± 0.1 (0.075 ± 0.004) | 2.45 ± 0.1 (0.097 ± 0.004) | 4.0 ± 0.1 (0.157 ± 0.004) | 0.25 ± 0.05 (0.009 ± 0.002) | 1.2 ± 0.1 (0.047 ± 0.004) |
| 2016KK | 1.9 ± 0.1 (0.075 ± 0.004) | 2.45 ± 0.1 (0.097 ± 0.004) | 4.0 ± 0.1 (0.157 ± 0.004) | 0.25 ± 0.05 (0.009 ± 0.002) | 1.2 ± 0.1 (0.047 ± 0.004) |

▶ This catalog contains the typical specification only due to the limitation of space. When you consider the purchase of our products, please check our specification. For details of each product (characteristics graph, reliability information, precautions for use, and so on), see our Web site (<http://www.ty-top.com/>).

| Type | Chip cavity | | Insertion pitch | Tape thickness | |
|--------|--------------------------|--------------------------|--------------------------|----------------------------|--------------------------|
| | A | B | | T | K |
| 2520KK | 2.4±0.1 (0.094±0.004) | 2.9±0.1 (0.114±0.004) | 4.0±0.1 (0.157±0.004) | 0.25±0.05 (0.009±0.002) | 1.1±0.1 (0.043±0.004) |
| 2520MK | 2.4±0.1 (0.094±0.004) | 2.9±0.1 (0.114±0.004) | 4.0±0.1 (0.157±0.004) | 0.25±0.05 (0.009±0.002) | 1.4±0.1 (0.055±0.004) |
| 3225HK | 2.8±0.1 (0.110±0.004) | 3.5±0.1 (0.138±0.004) | 4.0±0.1 (0.157±0.004) | 0.25±0.05 (0.009±0.002) | 1.1±0.1 (0.043±0.004) |

Unit: mm (inch)

④ Leader and Blank portion

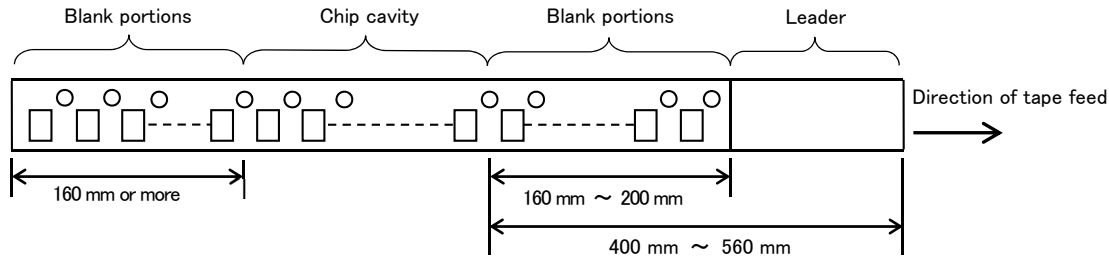

⑤ Reel size

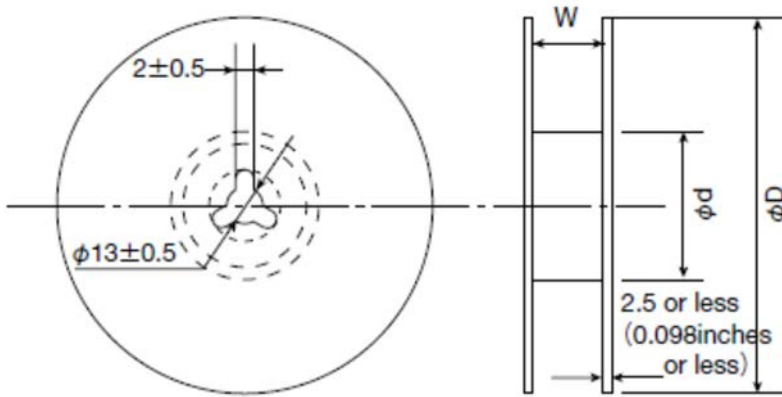

| Type | Reel size (Reference values) | | |
|--------|------------------------------|---------------------------|---------------------------|
| | ϕD | ϕd | W |
| 2012HK | 180+0/-3 (7.087+0/-0.118) | 60+1/-0 (2.36+0.039/0) | 10.0±1.5 (0.394±0.059) |
| 2012KK | | | |
| 2016MK | | | |
| 2016HK | | | |
| 2016KK | | | |
| 2520KK | | | |
| 2520MK | | | |
| 3225HK | | | |

Unit: mm (inch)

⑥ Top Tape Strength

The top The top tape requires a peel-off force of 0.1 to 1.0N in the direction of the arrow as illustrated below.

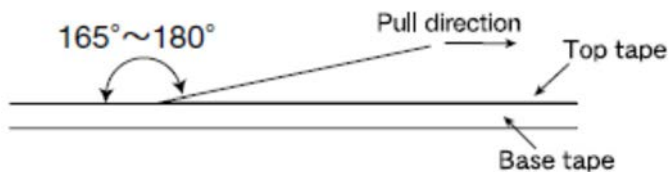

► This catalog contains the typical specification only due to the limitation of space. When you consider the purchase of our products, please check our specification. For details of each product (characteristics graph, reliability information, precautions for use, and so on), see our Web site (<http://www.ty-top.com/>).

Wire-wound Metal Power Inductors MCOIL™ LSEU series for General Electronic Equipment for Consumer
Wire-wound Metal Power Inductors MCOIL™ LLEU series
for Medical Devices classified as GHTF Classes A or B (Japan Classes I or II)

■ RELIABILITY DATA

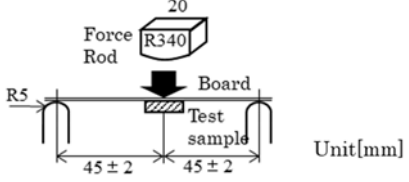
| 1. Operating Temperature Range | |
|---------------------------------------|--|
| Specified Value | -40~+125°C |
| Test Methods and Remarks | Including self-generated heat |
| 2. Storage Temperature Range | |
| Specified Value | -40~+85°C |
| Test Methods and Remarks | 0 to 40°C for the product with taping. |
| 3. Rated current | |
| Specified Value | Within the specified tolerance |
| 4. Inductance | |
| Specified Value | Within the specified tolerance |
| Test Methods and Remarks | Measuring equipment : LCR Meter (HP 4294A or equivalent) Measuring frequency : 1MHz, 0.5V |
| 5. DC Resistance | |
| Specified Value | Within the specified tolerance |
| Test Methods and Remarks | Measuring equipment : DC ohmmeter (HIOKI 3227 or equivalent) |
| 6. Temperature characteristic | |
| Specified Value | Inductance change : Within $\pm 15\%$ |
| Test Methods and Remarks | Measurement of inductance shall be taken at temperature range within -40°C~+125°C. With reference to inductance value at +20°C., change rate shall be calculated. |
| 7. Resistance to flexure of substrate | |
| Specified Value | No damage |
| Test Methods and Remarks | <p>The test samples shall be soldered to the test board by the reflow. As illustrated below, apply force in the direction of the arrow indicating until deflection of the test board reaches to 2 mm.</p> <p>Test board size : 100 × 40 × 1.0 mm Test board material : Glass epoxy-resin Solder cream thickness : 0.10 mm</p>  |
| 8. Adhesion of terminal electrode | |
| Specified Value | No abnormality. |
| Test Methods and Remarks | The test samples shall be soldered to the test board by the reflow. Applied force : 10N Duration : 5s. Solder cream thickness : 0.10mm |

▶ This catalog contains the typical specification only due to the limitation of space. When you consider the purchase of our products, please check our specification.
 For details of each product (characteristics graph, reliability information, precautions for use, and so on), see our Web site (<http://www.ty-top.com/>).

9. Resistance to vibration

| | | | | | | | | | | | |
|---|--|--|---------|-----------------|--|-----------------|--------------------------------|------|---|---|---|
| Specified Value | Inductance change : Within $\pm 10\%$ No significant abnormality in appearance. | | | | | | | | | | |
| Test Methods and Remarks | The test samples shall be soldered to the test board by the reflow. Then it shall be submitted to below test conditions. | | | | | | | | | | |
| | <table border="1"> <tr> <td>Frequency Range</td> <td>10~55Hz</td> </tr> <tr> <td>Total Amplitude</td> <td>1.5mm (May not exceed acceleration 196m/s²)</td> </tr> <tr> <td>Sweeping Method</td> <td>10Hz to 55Hz to 10Hz for 1min.</td> </tr> <tr> <td rowspan="3">Time</td> <td>X</td> </tr> <tr> <td>Y</td> </tr> <tr> <td>Z</td> </tr> </table> | Frequency Range | 10~55Hz | Total Amplitude | 1.5mm (May not exceed acceleration 196m/s ²) | Sweeping Method | 10Hz to 55Hz to 10Hz for 1min. | Time | X | Y | Z |
| | Frequency Range | 10~55Hz | | | | | | | | | |
| | Total Amplitude | 1.5mm (May not exceed acceleration 196m/s ²) | | | | | | | | | |
| Sweeping Method | 10Hz to 55Hz to 10Hz for 1min. | | | | | | | | | | |
| Time | X | | | | | | | | | | |
| | Y | | | | | | | | | | |
| | Z | | | | | | | | | | |
| For 2 hours on ach X, Y, and Z axis. | | | | | | | | | | | |
| Recovery : At least 2hrs of recovery under the standard condition after the test, followed by the measurement within 48hrs. | | | | | | | | | | | |

10. Solderability

| | | | | | |
|--|--|--------------------------|--------------------------|------|------------------|
| Specified Value | At least 90% of surface of terminal electrode is covered by new solder. | | | | |
| Test Methods and Remarks | The test samples shall be dipped in flux, and then immersed in molten solder as shown in below table. Flux : Ethanol solution containing rosin 25%. | | | | |
| | <table border="1"> <tr> <td>Solder Temperature</td> <td>245\pm5$^{\circ}$C</td> </tr> <tr> <td>Time</td> <td>5\pm0.5 sec.</td> </tr> </table> | Solder Temperature | 245 \pm 5 $^{\circ}$ C | Time | 5 \pm 0.5 sec. |
| | Solder Temperature | 245 \pm 5 $^{\circ}$ C | | | |
| | Time | 5 \pm 0.5 sec. | | | |
| ※Immersion depth : All sides of mounting terminal shall be immersed. | | | | | |

11. Resistance to soldering heat

| | |
|--------------------------|--|
| Specified Value | Inductance change : Within $\pm 10\%$ No significant abnormality in appearance. |
| Test Methods and Remarks | The test sample shall be exposed to reflow oven at 230 $^{\circ}$ C for 40 seconds, with peak temperature at 260+0/-5 $^{\circ}$ C for 5 seconds, 2 times. |
| | Test board material : Glass epoxy-resin |
| | Test board thickness : 1.6mm |
| | Recovery : At least 2hrs of recovery under the standard condition after the test, followed by the measurement within 48hrs. |

12. Thermal shock

| Specified Value | Inductance change : Within $\pm 10\%$ No significant abnormality in appearance. | | | | | | | | | |
|---|--|-----------------------------|-----------------------------|----------------|---|-------------|------------|---|-------------|------------|
| Test Methods and Remarks | The test samples shall be soldered to the test board by the reflow. The test samples shall be placed at specified temperature for specified time by step 1 to step 2 as shown in below table in sequence. The temperature cycle shall be repeated 100 cycles. | | | | | | | | | |
| | Conditions of 1 cycle | | | | | | | | | |
| | <table border="1"> <thead> <tr> <th>Step</th> <th>Temperature ($^{\circ}$C)</th> <th>Duration (min)</th> </tr> </thead> <tbody> <tr> <td>1</td> <td>-40\pm5</td> <td>30\pm3</td> </tr> <tr> <td>2</td> <td>+85\pm5</td> <td>30\pm3</td> </tr> </tbody> </table> | Step | Temperature ($^{\circ}$ C) | Duration (min) | 1 | -40 \pm 5 | 30 \pm 3 | 2 | +85 \pm 5 | 30 \pm 3 |
| | Step | Temperature ($^{\circ}$ C) | Duration (min) | | | | | | | |
| | 1 | -40 \pm 5 | 30 \pm 3 | | | | | | | |
| 2 | +85 \pm 5 | 30 \pm 3 | | | | | | | | |
| Recovery : At least 2hrs of recovery under the standard condition after the test, followed by the measurement within 48hrs. | | | | | | | | | | |

13. Damp heat

| | | | | | | | |
|---|--|-------------------------|-------------------------|----------|---------------|------|----------|
| Specified Value | Inductance change : Within $\pm 10\%$ No significant abnormality in appearance. | | | | | | |
| Test Methods and Remarks | The test samples shall be soldered to the test board by the reflow. The test samples shall be placed in thermostatic oven set at specified temperature and humidity as shown in below table. | | | | | | |
| | <table border="1"> <tr> <td>Temperature</td> <td>85\pm2$^{\circ}$C</td> </tr> <tr> <td>Humidity</td> <td>85\pm5%RH</td> </tr> <tr> <td>Time</td> <td>500 hour</td> </tr> </table> | Temperature | 85 \pm 2 $^{\circ}$ C | Humidity | 85 \pm 5%RH | Time | 500 hour |
| | Temperature | 85 \pm 2 $^{\circ}$ C | | | | | |
| | Humidity | 85 \pm 5%RH | | | | | |
| Time | 500 hour | | | | | | |
| Recovery : At least 2hrs of recovery under the standard condition after the test, followed by the measurement within 48hrs. | | | | | | | |

14. High temperature life test

| | | | | | |
|---|--|--------------------------|--------------------------|------|----------|
| Specified Value | Inductance change : Within $\pm 10\%$ No significant abnormality in appearance. | | | | |
| Test Methods and Remarks | The test samples shall be soldered to the test board by the reflow. After that, the test samples shall be placed at test conditions as shown in below table. | | | | |
| | <table border="1"> <tr> <td>Temperature</td> <td>125\pm2$^{\circ}$C</td> </tr> <tr> <td>Time</td> <td>500 hour</td> </tr> </table> | Temperature | 125 \pm 2 $^{\circ}$ C | Time | 500 hour |
| | Temperature | 125 \pm 2 $^{\circ}$ C | | | |
| Time | 500 hour | | | | |
| Recovery : At least 2hrs of recovery under the standard condition after the test, followed by the measurement within 48hrs. | | | | | |

▶ This catalog contains the typical specification only due to the limitation of space. When you consider the purchase of our products, please check our specification. For details of each product (characteristics graph, reliability information, precautions for use, and so on), see our Web site (<http://www.ty-top.com/>).

15. Loading at high temperature life test

| | | | | | | | |
|---|--|----------------------------|----------------------------|-----------------|---------------|------|---------|
| Specified Value | Inductance change : Within $\pm 10\%$ No significant abnormality in appearance. | | | | | | |
| Test Methods and Remarks | The test samples shall be soldered to the test board by the reflow. After that, the test samples shall be placed at test conditions as shown in below table. | | | | | | |
| | <table border="1"><tr><td>Temperature</td><td>$85 \pm 2^{\circ}\text{C}$</td></tr><tr><td>Applied current</td><td>Rated current</td></tr><tr><td>Time</td><td>500hour</td></tr></table> | Temperature | $85 \pm 2^{\circ}\text{C}$ | Applied current | Rated current | Time | 500hour |
| | Temperature | $85 \pm 2^{\circ}\text{C}$ | | | | | |
| | Applied current | Rated current | | | | | |
| Time | 500hour | | | | | | |
| Recovery : At least 2hrs of recovery under the standard condition after the test, followed by the measurement within 48hrs. | | | | | | | |
| | | | | | | | |

16. Standard condition

| | |
|-----------------|--|
| Specified Value | Standard test condition : Unless otherwise specified, temperature is $20 \pm 15^{\circ}\text{C}$ and $65 \pm 20\%$ of relative humidity. When there is any question concerning measurement result: In order to provide correlation data, the test shall be condition of $20 \pm 2^{\circ}\text{C}$ of temperature, $65 \pm 5\%$ relative humidity. Inductance is in accordance with our measured value. |
|-----------------|--|

Wire-wound Metal Power Inductors MCOIL™ LSEN/LLEN/LCEN/LBEN/LMEN series

Wire-wound Metal Power Inductors MCOIL™ LSEP/LLEP series

Wire-wound Metal Power Inductors MCOIL™ LSEU/LLEU series

■ PRECAUTIONS

| 1. Circuit Design | |
|---|--|
| Precautions | <ul style="list-style-type: none"> ◆ Verification of operating environment, electrical rating and performance <ol style="list-style-type: none"> 1. A malfunction in medical equipment, spacecraft, nuclear reactors, etc. may cause serious harm to human life or have severe social ramifications. As such, any inductors to be used in such equipment may require higher safety and/or reliability considerations and should be clearly differentiated from components used in general purpose applications. 2. When inductors are used in places where dew condensation develops and/or where corrosive gas such as hydrogen sulfide, sulfurous acid, or chlorine exists in the air, characteristic deterioration may occur. Please do not use inductors under such environmental conditions. ◆ Operating Current (Verification of Rated current) <ol style="list-style-type: none"> 1. The operating current including inrush current for inductors must always be lower than their rated values. 2. Do not apply current in excess of the rated value because the inductance may be reduced due to the magnetic saturation effect. ◆ Temperature rise <p>Temperature rise of power choke coil depends on the installation condition in end products.</p> <p>Make sure that temperature rise of power choke coils in actual end products is within the specified temperature range.</p> |
| 2. PCB Design | |
| Precautions | <ul style="list-style-type: none"> ◆ Land pattern design <ol style="list-style-type: none"> 1. Please refer to a recommended land pattern. |
| Technical considerations | <ul style="list-style-type: none"> ◆ Land pattern design <p>Surface Mounting</p> <ul style="list-style-type: none"> • Mounting and soldering conditions should be checked beforehand. • Applicable soldering process to this products is reflow soldering only. |
| 3. Considerations for automatic placement | |
| Precautions | <ul style="list-style-type: none"> ◆ Adjustment of mounting machine <ol style="list-style-type: none"> 1. Excessive impact load should not be imposed on the products when mounting onto the PC boards. 2. Mounting and soldering conditions should be checked beforehand. |
| Technical considerations | <ul style="list-style-type: none"> ◆ Adjustment of mounting machine <ol style="list-style-type: none"> 1. When installing products, care should be taken not to apply distortion stress as it may deform the products. |
| 4. Soldering | |
| Precautions | <ul style="list-style-type: none"> ◆ Reflow soldering <ol style="list-style-type: none"> 1. Please contact any of our offices for a reflow soldering, and refer to the recommended condition specified. 2. The product shall be used reflow soldering only. 3. Please do not add any stress to a product until it returns in normal temperature after reflow soldering. ◆ Lead free soldering <ol style="list-style-type: none"> 1. When using products with lead free soldering, we request to use them after confirming adhesion, temperature of resistance to soldering heat, soldering etc sufficiently. |
| Technical considerations | <ul style="list-style-type: none"> ◆ Reflow soldering <ol style="list-style-type: none"> 1. If products are used beyond the range of the recommended conditions, heat stresses may deform the products, and consequently degrade the reliability of the products. <p>Recommended reflow condition (Pb free solder)</p> |

▶ This catalog contains the typical specification only due to the limitation of space. When you consider the purchase of our products, please check our specification. For details of each product (characteristics graph, reliability information, precautions for use, and so on), see our Web site (<http://www.ty-top.com/>).

| 5. Cleaning | |
|--------------------------|--|
| Precautions | <ul style="list-style-type: none"> ◆ Cleaning conditions 1. Washing by supersonic waves shall be avoided. |
| Technical considerations | <ul style="list-style-type: none"> ◆ Cleaning conditions 1. If washed by supersonic waves, the products might be broken. |
| 6. Handling | |
| Precautions | <ul style="list-style-type: none"> ◆ Handling 1. Keep the product away from all magnets and magnetic objects. ◆ Breakaway PC boards (splitting along perforations) 1. When splitting the PC board after mounting product, care should be taken not to give any stresses of deflection or twisting to the board. 2. Board separation should not be done manually, but by using the appropriate devices. ◆ Mechanical considerations 1. Please do not give the product any excessive mechanical shocks. 2. Please do not add any shock and power to a product in transportation. ◆ Pick-up pressure 1. Please do not push to add any pressure to a winding part. Please do not give any shock and push into a ferrite core exposure part. ◆ Packing 1. Please avoid accumulation of a packing box as much as possible. |
| Technical considerations | <ul style="list-style-type: none"> ◆ Handling 1. There is a case that a characteristic varies with magnetic influence. ◆ Breakaway PC boards (splitting along perforations) 1. The position of the product on PCBs shall be carefully considered to minimize the stress caused from splitting of the PCBs. ◆ Mechanical considerations 1. There is a case to be damaged by a mechanical shock. 2. There is a case to be broken by the handling in transportation. ◆ Pick-up pressure 1. Damage and a characteristic can vary with an excessive shock or stress. ◆ Packing 1. If packing boxes are accumulated, that could cause a deformation on packing tapes or a damage on the products. |
| 7. Storage conditions | |
| Precautions | <ul style="list-style-type: none"> ◆ Storage 1. To maintain the solderability of terminal electrodes and to keep the packing material in good condition, temperature and humidity in the storage area should be controlled. <ul style="list-style-type: none"> ▪ Storage conditions Ambient temperature : 0~40°C Humidity : Below 70% RH ▪ The recommended ambient temperature is below 30°C. Even under ideal storage conditions, solderability of products electrodes may decrease as time passes. For this reason, product should be used within 6 months from the time of delivery. In case of storage over 6 months, solderability shall be checked before actual usage. |
| Technical considerations | <ul style="list-style-type: none"> ◆ Storage 1. Under a high temperature and humidity environment, problems such as reduced solderability caused by oxidation of terminal electrodes and deterioration of taping/packaging materials may take place. |

X-ON Electronics

Largest Supplier of Electrical and Electronic Components

Click to view similar products for [Power Inductors - SMD category](#):

Click to view products by [Taiyo Yuden manufacturer](#):

Other Similar products are found below :

[SPD62R-472M](#) [LLQPB201214T1R0M](#) [LLXND3030QKT470MNG](#) [LLQPB160807T4R7M](#) [LLAPB2016KKTR33M](#)
[LBXND4040TKL330MDG](#) [LSQEA201212T100M](#) [PA4300.474NLT](#) [LVS505020-1R0T-N](#) [LVS505040-1R2T-N](#) [LVS606020-1R5M-N](#)
[LVS606028-6R8M-N](#) [LVS606045-102M-N](#) [LVS606045-150M-N](#) [LVS606045-1R8M-N](#) [LVS606045-6R8M-N](#) [LVS808040-2R0M-N](#)
[LVS808040-330M-N](#) [LVS808040-4R7M-N](#) [MHCI06030-R56M-R8](#) [SCD0403T-470M-N](#) [SCD0403T-6R8K-N](#) [SCD0504T-101M-N](#)
[SCD0504T-120M-N](#) [SCD0504T-221M-N](#) [SCD0504T-470M-N](#) [SCD0504T-471M-N](#) [SCD0705T-180M-N](#) [SCD0705T-221M-N](#) [SCD0705T-470M-N](#) [SCD1005T-101M-N](#) [SCD1005T-221M-N](#) [SCD1005T-470M-N](#) [SSL1306T-101M-N](#) [LQB15NNR27K10D](#) [201610CDMCDDS-R47MC](#) [201610CDMCDDS-1R0MC](#) [201610CDMCDDS-R68MC](#) [LSQPB201210T220M](#) [LBCNF2012KKTR24MA](#) [LSQEA201212T220K](#)
[LSENC2016KKT1R0M](#) [LSQNB160808T470M](#) [LSBHB1608KKT2R2MG](#) [LSQPB160807T2R2M](#) [LSQEA201212T101K](#) [DEM8045Z-5R6N=P3](#) [LCXND3030QKT4R7MNG](#) [LSQPA322525T6R8MR](#) [LCXNH8080YKL101MJG](#)