

Notice for TAIYO YUDEN Products

Please read this notice before using the TAIYO YUDEN products.

REMINDERS

Product Information in this Catalog

Product information in this catalog is as of October 2021. All of the contents specified herein and production status of the products listed in this catalog are subject to change without notice due to technical improvement of our products, etc. Therefore, please check for the latest information carefully before practical application or use of our products.

Please note that TAIYO YUDEN shall not be in any way responsible for any damages and defects in products or equipment incorporating our products, which are caused under the conditions other than those specified in this catalog or individual product specification sheets.

Approval of Product Specifications

Please contact TAIYO YUDEN for further details of product specifications as the individual product specification sheets are available. When using our products, please be sure to approve our product specifications or make a written agreement on the product specification with TAIYO YUDEN in advance.

Pre-Evaluation in the Actual Equipment and Conditions

Please conduct validation and verification of our products in actual conditions of mounting and operating environment before using our products.

Safety Design

When using our products for high safety and/or reliability-required equipment or circuits, please fully perform safety and/or reliability evaluation. In addition, please install (i) systems equipped with a protection circuit and a protection device and/or (ii) systems equipped with a redundant circuit or other system to prevent an unsafe status in the event of a single fault for a failsafe design to ensure safety.

Intellectual Property Rights

Information contained in this catalog is intended to convey examples of typical performances and/or applications of our products and is not intended to make any warranty with respect to the intellectual property rights or any other related rights of TAIYO YUDEN or any third parties nor grant any license under such rights.

Limited Warranty

Please note that the scope of warranty for our products is limited to the delivered our products themselves conforming to the product specifications specified in the individual product specification sheets, and TAIYO YUDEN shall not be in any way responsible for any damages resulting from a failure or defect in our products. Notwithstanding the foregoing, if there is a written agreement (e.g., supply and purchase agreement, quality assurance agreement) signed by TAIYO YUDEN and your company, TAIYO YUDEN will warrant our products in accordance with such agreement, provided, however, that our products shall be used for general-purpose and standard use in the equipment specified in this catalog or the individual product specification sheets.

TAIYO YUDEN's Official Sales Channel

The contents of this catalog are applicable to our products which are purchased from our sales offices or authorized distributors (hereinafter "TAIYO YUDEN's official sales channel"). Please note that the contents of this catalog are not applicable to our products purchased from any seller other than TAIYO YUDEN's official sales channel.

Caution for Export

Some of our products listed in this catalog may require specific procedures for export according to "U.S. Export Administration Regulations", "Foreign Exchange and Foreign Trade Control Law" of Japan, and other applicable regulations. Should you have any questions on this matter, please contact our sales staff.

Limited Application

1. Equipment Intended for Use

The products listed in this catalog are intended for general-purpose and standard use in general electronic equipment for consumer (e.g., AV equipment, OA equipment, home electric appliances, office equipment, information and communication equipment including, without limitation, mobile phone, and PC) and other equipment specified in this catalog or the individual product specification sheets, or the equipment approved separately by TAIYO YUDEN.

TAIYO YUDEN has the product series intended for use in the following equipment. Therefore, when using our products for these equipment, please check available applications specified in this catalog or the individual product specification sheets and use the corresponding products.

Application	Product Series		Quality Grade ^{*3}
	Equipment ^{*1}	Category (Part Number Code ^{*2})	
Automotive	Automotive Electronic Equipment (POWERTRAIN, SAFETY)	A	1
	Automotive Electronic Equipment (BODY & CHASSIS, INFOTAINMENT)	C	2
Industrial	Telecommunications Infrastructure and Industrial Equipment	B	2
Medical	Medical Devices classified as GHTF Class C (Japan Class III)	M	2
	Medical Devices classified as GHTF Classes A or B (Japan Classes I or II)	L	3
Consumer	General Electronic Equipment	S	3

*Notes: 1. Based on the general specifications required for electronic components for such equipment, which are recognized by TAIYO YUDEN, the use of each product series for the equipment is recommended. Please be sure to contact TAIYO YUDEN before using our products for equipment other than those covered by the product series.

2. On each of our part number, the 2nd code from the left is a code indicating the "Category" as shown in the above table. For details, please check the explanatory materials regarding the part numbering system of each of our products.

3. Each product series is assigned a "Quality Grade" from 1 to 3 in order of higher quality. Please do not incorporate a product into any equipment with a higher Quality Grade than the Quality Grade of such product without the prior written consent of TAIYO YUDEN.

2. Equipment Requiring Inquiry

Please be sure to contact TAIYO YUDEN for further information before using the products listed in this catalog for the following equipment (excluding intended equipment as specified in this catalog or the individual product specification sheets) which may cause loss of human life, bodily injury, serious property damage and/or serious public impact due to a failure or defect of the products and/or malfunction attributed thereto.

- (1) Transportation equipment (automotive powertrain control system, train control system, and ship control system, etc.)
- (2) Traffic signal equipment
- (3) Disaster prevention equipment, crime prevention equipment
- (4) Medical devices classified as GHTF Class C (Japan Class III)
- (5) Highly public information network equipment, data-processing equipment (telephone exchange, and base station, etc.)
- (6) Any other equipment requiring high levels of quality and/or reliability equal to the equipment listed above

3. Equipment Prohibited for Use

Please do not incorporate our products into the following equipment requiring extremely high levels of safety and/or reliability.

- (1) Aerospace equipment (artificial satellite, rocket, etc.)
- (2) Aviation equipment ^{*1}
- (3) Medical devices classified as GHTF Class D (Japan Class IV), implantable medical devices ^{*2}
- (4) Power generation control equipment (nuclear power, hydroelectric power, thermal power plant control system, etc.)
- (5) Undersea equipment (submarine repeating equipment, etc.)
- (6) Military equipment
- (7) Any other equipment requiring extremely high levels of safety and/or reliability equal to the equipment listed above

*Notes: 1. There is a possibility that our products can be used only for aviation equipment that does not directly affect the safe operation of aircraft (e.g., in-flight entertainment, cabin light, electric seat, cooking equipment) if such use meets requirements specified separately by TAIYO YUDEN. Please be sure to contact TAIYO YUDEN for further information before using our products for such aviation equipment.

2. Implantable medical devices contain not only internal unit which is implanted in a body, but also external unit which is connected to the internal unit.

4. Limitation of Liability

Please note that unless you obtain prior written consent of TAIYO YUDEN, TAIYO YUDEN shall not be in any way responsible for any damages incurred by you or third parties arising from use of the products listed in this catalog for any equipment that is not intended for use by TAIYO YUDEN, or any equipment requiring inquiry to TAIYO YUDEN or prohibited for use by TAIYO YUDEN as described above.

Automotive Application Guide

We classify automotive electronic equipment into the following four application categories and set usable application categories for each of our products. Therefore, we have the corresponding product series (the part number code of 2nd digit from the left side is "A" or "C"). When using our products for automotive electronic equipment, please be sure to check such application categories and use the corresponding product series accordingly. Should you have any questions on this matter, please contact us.

Product Series (Part Number Code of 2nd digit from the Left Side)	Category	Automotive Electronic Equipment (Typical Example)
A	POWERTRAIN	<ul style="list-style-type: none"> • Engine ECU (Electronically Controlled Fuel Injector) • Cruise Control Unit • 4WS (4 Wheel Steering) • Transmission • Power Steering • HEV/PHV/EV Core Control (Battery, Inverter, DC-DC) • Automotive Locator (Car location information providing device), etc.
	SAFETY	<ul style="list-style-type: none"> • ABS (Anti-Lock Brake System) • ESC (Electronic Stability Control) • Airbag • ADAS (Equipment that directly controls running, turning and stopping), etc.
C	BODY & CHASSIS	<ul style="list-style-type: none"> • Wiper • Automatic Door • Power Window • Keyless Entry System • Electric Door Mirror • Automobile Digital Mirror • Interior Lighting • Automobile Air Conditioning System • TPMS (Tire Pressure Monitoring System) • Anti-Theft Device (Immobilizer), etc.
	INFOTAINMENT	<ul style="list-style-type: none"> • Car Infotainment System • ITS/Telematics System • Instrument Cluster • ADAS (Sensor, Equipment that is not interlocked with safety equipment or powertrain) • Dashcam (genuine products for automotive manufacturer), etc.

Multilayer Ceramic Capacitors for Automotive Body & Chassis and Infotainment

REFLOW

AEC-Q200

■ PART NUMBER

M	C	A	S	J	3	1	L	S	B	5	1	0	6	K	T	N	A	0	1
①	②	③	④	⑤	⑥	⑦	⑧	⑨	⑩										

① Series

Code (1)(2)(3)(4)	
MCAS	Multilayer Ceramic Capacitor (High dielectric type) for Automotive Body & Chassis and Infotainment Multilayer Ceramic Capacitor (Temperature compensating type) for Automotive Body & Chassis and Infotainment Medium-High voltage Multilayer Ceramic Capacitor for Automotive Body & Chassis and Infotainment
MCAR	High frequency/Low loss Medium-High Voltage Multilayer Ceramic Capacitor for Automotive Body & Chassis and Infotainment
MCJC	Soft Termination Multilayer Ceramic Capacitor for Automotive Body & Chassis and Infotainment
MCRL	LW Reversal Decoupling Low ESL Capacitor (LWDC™) for Automotive Body & Chassis and Infotainment

(1) Product Group

Code	
M	Multilayer Ceramic Capacitor

(2) Category

Code	Recommended equipment	Quality Grade
C	Automotive Electronic Equipment (Body & Chassis, Infotainment)	2

(3) Type

Code	
A	2 terminals
J	Soft Termination
R	LW reversal

(4) Features, Characteristics

Code	
S	Standard/General
R	High frequency/Low loss
C	Internal code (Soft Termination)
L	Low ESL

② Rated voltage

Code	Rated voltage [VDC]
A	4
J	6.3
L	10
E	16
T	25
G	35
U	50
H	100
Q	250
S	630

④ Thickness

Code	Thickness [mm]
3	0.3
5	0.5
7	0.7
8	0.8
9	0.85
Q	1.15
G	1.25
L	1.6
N	1.9 (0.088 max ※)
M	2.5

Note : ※LW reverse type (MCRL)

③ Dimension (L × W)

Code	L × W [mm]	JIS(mm)	EIA(inch)
06	0.6 × 0.3	0603	0201
10	1.0 × 0.5	1005	0402
	0.52 × 1.0 ※	0510	0204
16	1.6 × 0.8	1608	0603
	0.8 × 1.6 ※	0816	0306
21	2.0 × 1.25	2012	0805
	1.25 × 2.0 ※	1220	0508
31	3.2 × 1.6	3216	1206
32	3.2 × 2.5	3225	1210
45	4.5 × 3.2	4532	1812

Note : ※LW reverse type (MCRL)

⑤Dimension tolerance

Code	Dimension code	L[mm]	W[mm]	T[mm]	Thickness code
A	10	1.0±0.10	0.5±0.10	0.5±0.10	5
	16	1.6+0.15/-0.05	0.8+0.15/-0.05	0.8+0.15/-0.05	8
	21	2.0+0.15/-0.05	1.25+0.15/-0.05	1.25+0.15/-0.05	G
	31	3.2±0.20	1.6±0.20	1.15±0.20	Q
				1.6±0.20	L
32	3.2±0.30	2.5±0.30	2.5±0.30	M	
B	10	1.0+0.15/-0.05	0.5+0.15/-0.05	0.5+0.15/-0.05	5
	16	1.6+0.20/-0	0.8+0.20/-0	0.8+0.20/-0	8
	21	2.0+0.20/-0	1.25+0.20/-0	1.25+0.20/-0	G
	31	3.2±0.30	1.6±0.30	1.6±0.30	L
C	10	1.0+0.20/-0	0.5+0.20/-0	0.5+0.20/-0	5
	16	1.6+0.25/-0	0.8+0.25/-0	0.8+0.25/-0	8
	21	2.0+0.25/-0	1.25+0.25/-0	1.25+0.25/-0	G
D	21	2.0+0.30/-0	1.25+0.30/-0	1.25+0.30/-0	G
H	31	3.2±0.15	1.6±0.15	1.15±0.10	Q
J	21	2.0+0.15/-0.05	1.25+0.15/-0.05	0.85±0.10	9
L	21	2.0+0.20/-0	1.25+0.20/-0	0.85±0.10	9
	32	3.2±0.50	2.5±0.30	2.5±0.30	M
N	21	2.0±0.15	1.25±0.15	0.85±0.15	9
S	06	0.6±0.03	0.3±0.03	0.3±0.03	3
		1.0±0.05	0.5±0.05	0.5±0.05	5
	10	0.52±0.05 ※	1.0±0.05	0.3±0.05	3
				0.7±0.10	7
		1.6±0.10	0.8±0.10	8	
			0.8±0.10 ※	1.6±0.10	0.5±0.05
	21	2.0±0.10	1.25±0.10	0.85±0.10	9
				1.25±0.10	G
		1.25±0.15 ※	2.0±0.15	0.85±0.10	9
	31	3.2±0.15	1.6±0.15	1.6±0.20	L
	32	3.2±0.30	2.5±0.20	1.9±0.20	N
2.5±0.20				M	
45	4.5±0.40	3.2±0.30	2.5±0.20	M	

Note :※LW reverse type (MCRL)

⑥ Temperature characteristics code

■ High dielectric type

Code	Applicable standard		Temperature range [°C]	Ref. Temp. [°C]	Capacitance change	Capacitance tolerance	Tolerance code
B5	EIA	X5R	-55 ~ + 85	25	± 15%	± 10%	K
						± 20%	M
C6	EIA	X6S	-55 ~ + 105	25	± 22%	± 10%	K
						± 20%	M
B7	EIA	X7R	-55 ~ + 125	25	± 15%	± 10%	K
						± 20%	M
C7	EIA	X7S	-55 ~ + 125	25	± 22%	± 10%	K
						± 20%	M
D7	EIA	X7T	-55 ~ + 125	25	+ 22% / - 33%	± 10%	K
						± 20%	M

■ Temperature compensating type

Code	Applicable standard		Temperature range [°C]	Ref. Temp. [°C]	Capacitance change	Capacitance tolerance	Tolerance code
CG	JIS	CG	-55 ~ + 125	20	0 ± 30ppm/°C	± 0.05pF	A
						± 0.1pF	B
	± 0.25pF	C					
	EIA	C0G		25		± 0.5pF	D
						± 2%	G
± 5%			J				
CH	JIS	CH	-55 ~ + 125	20	0 ± 60ppm/°C	± 0.25pF	C
						± 0.5pF	D
	EIA	C0H		25		± 5%	J
CJ	JIS	CJ	-55 ~ + 125	20	0 ± 120ppm/°C	± 0.25pF	C
	EIA	C0J					
CK	JIS	CK	-55 ~ + 125	20	0 ± 250ppm/°C	± 0.25pF	C
	EIA	C0K		25			

⑦ Nominal capacitance

Code (example)	Nominal capacitance
0R5	0.5pF
010	1pF
100	10pF
101	100pF
102	1,000pF
103	0.01μF
104	0.1μF
105	1μF
106	10μF
107	100μF

Note : R=Decimal point

⑧ Capacitance tolerance

Code	Capacitance tolerance
A	± 0.05pF
B	± 0.1pF
C	± 0.25pF
D	± 0.5pF
G	± 2%
J	± 5%
K	± 10%
M	± 20%

⑨ Packaging

Code	Packaging
F	φ178mm Taping (2mm pitch)
R	φ178mm Embossed Taping (4mm pitch)
T	φ178mm Taping (4mm pitch)
P	φ178mm Taping (4mm pitch, 1000 pcs/reel) 3225 type (Thickness code M)

⑩ Internal code

■ STANDARD EXTERNAL DIMENSIONS

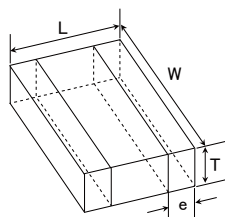
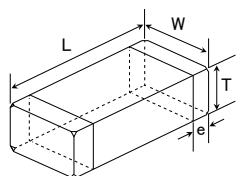

※LW reverse type

Type	JIS (mm)	EIA (inch)	Dimension [mm] (inch)				
			L	W	T	*1	e
MCAS□06	0603	0201	0.6±0.03 (0.024±0.001)	0.3±0.03 (0.012±0.001)	0.3±0.03 (0.012±0.001)	3	0.15±0.05 (0.006±0.002)
MCAR□10 MCAS□10	1005	0402	1.0±0.05 (0.039±0.002)	0.5±0.05 (0.020±0.002)	0.5±0.05 (0.020±0.002)	5	0.25±0.10 (0.010±0.004)
MCRL□10 ※	0510	0204	0.52±0.05 (0.020±0.002)	1.0±0.05 (0.039±0.002)	0.3±0.05 (0.012±0.002)	3	0.18±0.08 (0.007±0.003)
MCAS□16 MCAR□16	1608	0603	1.6±0.10 (0.063±0.004)	0.8±0.10 (0.031±0.004)	0.7±0.10 (0.028±0.004)	7	0.35±0.25 (0.014±0.010)
					0.8±0.10 (0.031±0.004)	8	
MCJC□16	1608	0603	1.6±0.10 (0.063±0.004)	0.8±0.10 (0.031±0.004)	0.8±0.10 (0.031±0.004)	8	0.35+0.3/-0.25 (0.014+0.012/-0.010)
MCRL□16 ※	0816	0306	0.8±0.10 (0.031±0.004)	1.6±0.10 (0.063±0.004)	0.5±0.05 (0.020±0.002)	5	0.25±0.15 (0.010±0.006)
MCAS□21 MCAR□21	2012	0805	2.0±0.10 (0.079±0.004)	1.25±0.10 (0.049±0.004)	0.85±0.10 (0.033±0.004)	9	0.5±0.25 (0.020±0.010)
					1.25±0.10 (0.049±0.004)	G	
MCJC□21	2012	0805	2.0±0.10 (0.079±0.004)	1.25±0.10 (0.049±0.004)	0.85±0.10 (0.033±0.004)	9	0.5+0.35/-0.25 (0.020+0.014/-0.010)
					1.25±0.10 (0.049±0.004)	G	
MCRL□21 ※	1220	0508	1.25±0.15 (0.049±0.006)	2.0±0.15 (0.079±0.006)	0.85±0.10 (0.033±0.004)	9	0.3±0.2 (0.012±0.008)
MCAS□31	3216	1206	3.2±0.15 (0.126±0.006)	1.6±0.15 (0.063±0.006)	1.15±0.10 (0.045±0.004)	Q	0.5+0.35/-0.25 (0.020+0.014/-0.010)
					1.6±0.20 (0.063±0.008)	L	
MCJC□31	3216	1206	3.2±0.15 (0.126±0.006)	1.6±0.15 (0.063±0.006)	1.15±0.10 (0.045±0.004)	Q	0.6+0.4/-0.3 (0.024+0.016/-0.012)
					1.6±0.20 (0.063±0.008)	L	
MCAS□32	3225	1210	3.2±0.30 (0.126±0.012)	2.5±0.20 (0.098±0.008)	1.9±0.20 (0.075±0.008)	N	0.6±0.3 (0.024±0.012)
					2.5±0.20 (0.098±0.008)	M	
MCJC□32	3225	1210	3.2±0.30 (0.126±0.012)	2.5±0.20 (0.098±0.008)	1.9±0.20 (0.075±0.008)	N	0.6+0.4/-0.3 (0.024+0.016/-0.012)
					2.5±0.20 (0.098±0.008)	M	
MCAS□45	4532	1812	4.5±0.40 (0.177±0.016)	3.2±0.30 (0.126±0.012)	2.5±0.20 (0.098±0.008)	M	0.9±0.6 (0.035±0.024)

Note :※LW reverse type (MCRL), *1.Thickness code

■ STANDARD QUANTITY

Type			Thickness		Standard quantity [pcs]	
Code	JIS(mm)	EIA(inch)	[mm]	Code	Paper tape	Embossed tape
06	0603	0201	0.3	3	15000	—
10	1005	0402	0.5	5	10000	—
	0510 ※	0204 ※	0.3	3		
16	1608	0603	0.7	7	4000	—
			0.8	8		
			0.8	8	3000 (Soft Termination)	3000 (Soft Termination)
			0.5	5	—	4000
21	2012	0805	0.85	9	4000	—
			1.25	G	—	3000
			1.25	G	—	2000 (Soft Termination)
			0.85	9	4000	—
31	3216	1206	1.15	Q	—	3000
			1.6	L	—	2000
32	3225	1210	1.9	N	—	2000
			2.5	M	—	500(T), 1000(P)
45	4532	1812	2.5	M	—	500

Note : ※.LW Reverse type (MCRL)

■ PART NUMBER

- All the Multilayer Ceramic Capacitors of the catalog lineup are RoHS compliant.
- Capacitance tolerance code is applied to □ of part number.
- All the Multilayer Ceramic Capacitors in the catalog lineup are applicable for reflow-soldering.

Notes)

- The exchange of individual specifications is necessary depending on your application and/or circuit condition. Please contact TAIYO YUDEN's official sales channel.
- For Automotive (AEC-Q200 Qualified) products for BODY & CHASSIS, and INFOTAINMENT. Please check "Automotive Application Guide" for further details before using the products.

< AEC-Q200 : AEC-Q200 qualified >

All the Multilayer Ceramic Capacitors for Automotive products are tested based on the test conditions and methods defined in AEC-Q200 by family item.

125°C products: AEC-Q200 Grade1 (we conduct the evaluation at the test condition of Grade1.)

105°C products: AEC-Q200 Grade2 (we conduct the evaluation at the test condition of Grade2.)

85°C products: AEC-Q200 Grade3 (we conduct the evaluation at the test condition of Grade3.)

Please consult with TAIYO YUDEN's official sales channel for the details of the product specifications and AEC-Q200 test results, etc.,

and please review and approve the product specifications before ordering.

- *1: For standard case size, please kindly refer to Dimension, Thickness, Dimension tolerance, and STANDARD EXTERNAL DIMENSIONS.

Multilayer Ceramic Capacitors (High dielectric type) for Automotive Body & Chassis and Infotainment

● 0603TYPE

[Temperature Characteristic B7 : X7R(-55~+125°C)] 0.3mm Thickness

New part number	Old part number (for reference)	Rated voltage [V]	Temperature characteristics	Capacitance [F]	Capacitance tolerance [%]	tan δ [%]	HTLT		Thickness*1 [mm]	Note
							Rated voltage x %			
MCAST063SB7101□FCA01	TMK063 B7101□PHFE	25	X7R	100 p	±10,±20	3.5	200		0.3±0.03	
MCAST063SB7151□FCA01	TMK063 B7151□PHFE	25	X7R	150 p	±10,±20	3.5	200		0.3±0.03	
MCAST063SB7221□FCA01	TMK063 B7221□PHFE	25	X7R	220 p	±10,±20	3.5	200		0.3±0.03	
MCAST063SB7331□FCA01	TMK063 B7331□PHFE	25	X7R	330 p	±10,±20	3.5	200		0.3±0.03	
MCAST063SB7471□FCA01	TMK063 B7471□PHFE	25	X7R	470 p	±10,±20	3.5	200		0.3±0.03	
MCAST063SB7102□FCA01	TMK063 B7102□PHFE	25	X7R	1000 p	±10,±20	3.5	200		0.3±0.03	
MCAST063SB7152□FCA01	TMK063 B7152□PHFE	25	X7R	1500 p	±10,±20	5	200		0.3±0.03	
MCAST063SB7222□FCA01	TMK063 B7222□PHFE	25	X7R	2200 p	±10,±20	5	200		0.3±0.03	
MCAST063SB7332□FCA01	TMK063 B7332□PHFE	25	X7R	3300 p	±10,±20	5	200		0.3±0.03	
MCASE063SB7101□FCA01	EMK063 B7101□PHFE	16	X7R	100 p	±10,±20	3.5	200		0.3±0.03	
MCASE063SB7151□FCA01	EMK063 B7151□PHFE	16	X7R	150 p	±10,±20	3.5	200		0.3±0.03	
MCASE063SB7221□FCA01	EMK063 B7221□PHFE	16	X7R	220 p	±10,±20	3.5	200		0.3±0.03	
MCASE063SB7331□FCA01	EMK063 B7331□PHFE	16	X7R	330 p	±10,±20	3.5	200		0.3±0.03	
MCASE063SB7471□FCA01	EMK063 B7471□PHFE	16	X7R	470 p	±10,±20	3.5	200		0.3±0.03	
MCASE063SB7102□FCA01	EMK063 B7102□PHFE	16	X7R	1000 p	±10,±20	3.5	200		0.3±0.03	
MCASE063SB7152□FCA01	EMK063 B7152□PHFE	16	X7R	1500 p	±10,±20	5	200		0.3±0.03	
MCASE063SB7222□FCA01	EMK063 B7222□PHFE	16	X7R	2200 p	±10,±20	5	200		0.3±0.03	
MCASE063SB7332□FCA01	EMK063 B7332□PHFE	16	X7R	3300 p	±10,±20	5	200		0.3±0.03	
MCASL063SB7101□FCA01	LMK063 B7101□PHFE	10	X7R	100 p	±10,±20	3.5	200		0.3±0.03	
MCASL063SB7151□FCA01	LMK063 B7151□PHFE	10	X7R	150 p	±10,±20	3.5	200		0.3±0.03	
MCASL063SB7221□FCA01	LMK063 B7221□PHFE	10	X7R	220 p	±10,±20	3.5	200		0.3±0.03	
MCASL063SB7331□FCA01	LMK063 B7331□PHFE	10	X7R	330 p	±10,±20	3.5	200		0.3±0.03	
MCASL063SB7471□FCA01	LMK063 B7471□PHFE	10	X7R	470 p	±10,±20	3.5	200		0.3±0.03	
MCASL063SB7102□FCA01	LMK063 B7102□PHFE	10	X7R	1000 p	±10,±20	3.5	200		0.3±0.03	
MCASL063SB7152□FCA01	LMK063 B7152□PHFE	10	X7R	1500 p	±10,±20	5	200		0.3±0.03	
MCASL063SB7222□FCA01	LMK063 B7222□PHFE	10	X7R	2200 p	±10,±20	5	200		0.3±0.03	
MCASL063SB7332□FCA01	LMK063 B7332□PHFE	10	X7R	3300 p	±10,±20	5	200		0.3±0.03	
MCASL063SB7472□FCA01	LMK063 B7472□PHFE	10	X7R	4700 p	±10,±20	5	200		0.3±0.03	
MCASL063SB7682□FCA01	LMK063 B7682□PHFE	10	X7R	6800 p	±10,±20	5	200		0.3±0.03	
MCASL063SB7103□FCA01	LMK063 B7103□PHFE	10	X7R	0.01 μ	±10,±20	5	200		0.3±0.03	
MCASJ063SD7104□FCA01	JMK063 D7104□PHFE	6.3	X7R	0.1 μ	±10,±20	10	200		0.3±0.03	

▶ This catalog contains the typical specification only due to the limitation of space. When you consider the purchase of our products, please check our specification.
For details of each product (characteristics graph, reliability information, precautions for use, and so on), see our Web site (<http://www.ty-top.com/>).

PART NUMBER

1005TYPE

【Temperature Characteristic B5 (BJ) : X5R(-55~+85°C)】 0.5mm Thickness

New part number	Old part number (for reference)	Rated voltage [V]	Temperature characteristics	Capacitance [F]	Capacitance tolerance [%]	tan δ [%]	HHLT		Thickness*1 [mm]	Note
							Rated voltage x %			
MCASU105SB5471□FNA01	UMK105 BJ471□VHF	50	X5R	470 p	±10, ±20	2.5	200		0.5±0.05	
MCASU105SB5102□FNA01	UMK105 BJ102□VHF	50	X5R	1000 p	±10, ±20	2.5	200		0.5±0.05	
MCASU105SB5152□FNA01	UMK105 BJ152□VHF	50	X5R	1500 p	±10, ±20	2.5	200		0.5±0.05	
MCASU105SB5222□FNA01	UMK105 BJ222□VHF	50	X5R	2200 p	±10, ±20	2.5	200		0.5±0.05	
MCASU105SB5332□FNA01	UMK105 BJ332□VHF	50	X5R	3300 p	±10, ±20	2.5	200		0.5±0.05	
MCASU105SB5472□FNA01	UMK105 BJ472□VHF	50	X5R	4700 p	±10, ±20	2.5	200		0.5±0.05	
MCASU105SB5682□FNA01	UMK105 BJ682□VHF	50	X5R	6800 p	±10, ±20	2.5	150		0.5±0.05	
MCASU105SB5103□FNA01	UMK105 BJ103□VHF	50	X5R	0.01 μ	±10, ±20	3.5	200		0.5±0.05	
MCASU105SB5223□FNA01	UMK105 BJ223□VHF	50	X5R	0.022 μ	±10, ±20	5	200		0.5±0.05	
MCASU105SB5473□FNA01	UMK105 BJ473□VHF	50	X5R	0.047 μ	±10, ±20	5	200		0.5±0.05	
MCASU105SB5104□FNA01	UMK105 BJ104□VHF	50	X5R	0.1 μ	±10, ±20	10	150		0.5±0.05	
MCAST105SB5472□FNA01	TMK105 BJ472□VHF	25	X5R	4700 p	±10, ±20	2.5	200		0.5±0.05	
MCAST105SB5682□FNA01	TMK105 BJ682□VHF	25	X5R	6800 p	±10, ±20	2.5	200		0.5±0.05	
MCAST105SB5103□FNA01	TMK105 BJ103□VHF	25	X5R	0.01 μ	±10, ±20	3.5	200		0.5±0.05	
MCAST105SB5153□FNA01	TMK105 BJ153□VHF	25	X5R	0.015 μ	±10, ±20	3.5	200		0.5±0.05	
MCAST105SB5223□FNA01	TMK105 BJ223□VHF	25	X5R	0.022 μ	±10, ±20	3.5	200		0.5±0.05	
MCAST105SB5333□FNA01	TMK105 BJ333□VHF	25	X5R	0.033 μ	±10, ±20	3.5	150		0.5±0.05	
MCAST105SB5473□FNA01	TMK105 BJ473□VHF	25	X5R	0.047 μ	±10, ±20	3.5	150		0.5±0.05	
MCAST105SB5104□FNA01	TMK105 BJ104□VHF	25	X5R	0.1 μ	±10, ±20	5	150		0.5±0.05	
MCAST105SB5224□FNA01	TMK105 BJ224□VHF	25	X5R	0.22 μ	±10, ±20	10	150		0.5±0.05	
MCAST105AB5474□FNA01	TMK105ABJ474□VHF	25	X5R	0.47 μ	±10, ±20	10	150		0.5±0.10	
MCASE105SB5103□FNA01	EMK105 BJ103□VHF	16	X5R	0.01 μ	±10, ±20	3.5	200		0.5±0.05	
MCASE105SB5153□FNA01	EMK105 BJ153□VHF	16	X5R	0.015 μ	±10, ±20	3.5	200		0.5±0.05	
MCASE105SB5223□FNA01	EMK105 BJ223□VHF	16	X5R	0.022 μ	±10, ±20	3.5	200		0.5±0.05	
MCASE105SB5333□FNA01	EMK105 BJ333□VHF	16	X5R	0.033 μ	±10, ±20	3.5	150		0.5±0.05	
MCASE105SB5473□FNA01	EMK105 BJ473□VHF	16	X5R	0.047 μ	±10, ±20	3.5	150		0.5±0.05	
MCASE105SB5104□FNA01	EMK105 BJ104□VHF	16	X5R	0.1 μ	±10, ±20	5	150		0.5±0.05	
MCASE105SB5224□FNA01	EMK105 BJ224□VHF	16	X5R	0.22 μ	±10, ±20	10	150		0.5±0.05	
MCASE105AB5474□FNA01	EMK105ABJ474□VHF	16	X5R	0.47 μ	±10, ±20	10	150		0.5±0.10	
MCASE105SB5105□FNA01	EMK105 BJ105□VHF	16	X5R	1 μ	±10, ±20	10	150		0.5±0.05	
MCASL105SB5333□FNA01	LMK105 BJ333□VHF	10	X5R	0.033 μ	±10, ±20	3.5	150		0.5±0.05	
MCASL105SB5473□FNA01	LMK105 BJ473□VHF	10	X5R	0.047 μ	±10, ±20	3.5	150		0.5±0.05	
MCASL105SB5104□FNA01	LMK105 BJ104□VHF	10	X5R	0.1 μ	±10, ±20	5	150		0.5±0.05	
MCASL105SB5224□FNA01	LMK105 BJ224□VHF	10	X5R	0.22 μ	±10, ±20	5	150		0.5±0.05	
MCASL105AB5474□FNA01	LMK105ABJ474□VHF	10	X5R	0.47 μ	±10, ±20	10	150		0.5±0.10	
MCASL105SB5105□FNA01	LMK105 BJ105□VHF	10	X5R	1 μ	±10, ±20	10	150		0.5±0.05	
MCASL105AB5225□FNA01	LMK105ABJ225□VHF	10	X5R	2.2 μ	±10, ±20	10	150		0.5±0.10	
MCASJ105SB5104□FNA01	JMK105 BJ104□VHF	6.3	X5R	0.1 μ	±10, ±20	5	150		0.5±0.05	
MCASJ105SB5224□FNA01	JMK105 BJ224□VHF	6.3	X5R	0.22 μ	±10, ±20	5	150		0.5±0.05	
MCASJ105SB5474□FNA01	JMK105 BJ474□VHF	6.3	X5R	0.47 μ	±10, ±20	10	150		0.5±0.05	
MCASJ105SB5105□FNA01	JMK105 BJ105□VHF	6.3	X5R	1 μ	±10, ±20	10	150		0.5±0.05	
MCASJ105SB5225□FNA01	JMK105 BJ225□VHF	6.3	X5R	2.2 μ	±10, ±20	10	150		0.5±0.05	
MCASJ105BB5475MFNA01	JMK105BBJ475MVHF	6.3	X5R	4.7 μ	±20	10	150		0.5+0.15/-0.05	
MCASA105SB5225□FNA01	AMK105 BJ225□VHF	4	X5R	2.2 μ	±10, ±20	10	150		0.5±0.05	
MCASA105BB5475MFNA01	AMK105BBJ475MVHF	4	X5R	4.7 μ	±20	10	150		0.5+0.15/-0.05	

【Temperature Characteristic B7 : X7R(-55~+125°C), D7 : X7T(-55~+125°C)】 0.5mm Thickness

New part number	Old part number (for reference)	Rated voltage [V]	Temperature characteristics	Capacitance [F]	Capacitance tolerance [%]	tan δ [%]	HHLT		Thickness*1 [mm]	Note
							Rated voltage x %			
MCASE105AC6474□FNA01	EMK105AC6474□VHF	16	X6S	0.47 μ	±10, ±20	10	150		0.5±0.10	
MCASL105SC6105□FNA01	LMK105 C6105□VHF	10	X6S	1 μ	±10, ±20	10	150		0.5±0.05	
MCASJ105SC6105□FNA01	JMK105 C6105□VHF	6.3	X6S	1 μ	±10, ±20	10	150		0.5±0.05	

PART NUMBER

【Temperature Characteristic B5 (BJ) : X5R(-55~+85°C)】 0.85mm Thickness

New part number	Old part number (for reference)	Rated voltage [V]	Temperature characteristics	Capacitance [F]	Capacitance tolerance [%]	tan δ [%]	HTLT		Thickness*1 [mm]	Note
							Rated voltage x %			
MCASE219SB5105□TNA01	EMK212 BJ105□DHT	16	X5R	1 μ	±10, ±20	5	200		0.85±0.10	
MCASE219JB5225□TNA01	EMK212ABJ225□DHT	16	X5R	2.2 μ	±10, ±20	5	150		0.85±0.10	
MCASE219LB5475□TNA01	EMK212BBJ475□DHT	16	X5R	4.7 μ	±10, ±20	10	150		0.85±0.10	

【Temperature Characteristic C6: X6S(-55~+105°C)】 0.85mm Thickness

New part number	Old part number (for reference)	Rated voltage [V]	Temperature characteristics	Capacitance [F]	Capacitance tolerance [%]	tan δ [%]	HTLT		Thickness*1 [mm]	Note
							Rated voltage x %			
MCASL21GBC6106□TNA01	LMK212BC6106□GHT	10	X6S	10 μ	±10, ±20	10	150		1.25+0.20/-0	
MCASA21GBC6226MTNA01	AMK212BC6226MGHT	4	X6S	22 μ	±20	10	150		1.25+0.20/-0	

【Temperature Characteristic B7 : X7R(-55~+125°C), C7 : X7S(-55~+125°C)】 1.25mm Thickness

New part number	Old part number (for reference)	Rated voltage [V]	Temperature characteristics	Capacitance [F]	Capacitance tolerance [%]	tan δ [%]	HTLT		Thickness*1 [mm]	Note
							Rated voltage x %			
MCASU21GSB7103□TNA01	UMK212 B7103□GHT	50	X7R	0.01 μ	±10, ±20	3.5	200		1.25±0.10	
MCASU21GSB7153□TNA01	UMK212 B7153□GHT	50	X7R	0.015 μ	±10, ±20	2.5	200		1.25±0.10	
MCASU21GSB7223□TNA01	UMK212 B7223□GHT	50	X7R	0.022 μ	±10, ±20	3.5	200		1.25±0.10	
MCASU21GSB7333□TNA01	UMK212 B7333□GHT	50	X7R	0.033 μ	±10, ±20	3.5	200		1.25±0.10	
MCASU21GSB7473□TNA01	UMK212 B7473□GHT	50	X7R	0.047 μ	±10, ±20	3.5	200		1.25±0.10	
MCASU21GSB7683□TNA01	UMK212 B7683□GHT	50	X7R	0.068 μ	±10, ±20	3.5	200		1.25±0.10	
MCASU21GSB7104□TNA01	UMK212 B7104□GHT	50	X7R	0.1 μ	±10, ±20	3.5	200		1.25±0.10	
MCASU21GGB7154□TCA01	UMK212BB7154□GHTE	50	X7R	0.15 μ	±10, ±20	3.5	200		1.25+0.2/-0	
MCASU21GSB7224□TNA01	UMK212 B7224□GHT	50	X7R	0.22 μ	±10, ±20	3.5	150		1.25±0.10	
MCASU21GBC7334□TCA01	UMK212BC7334□GHTE	50	X7S	0.33 μ	±10, ±20	3.5	150		1.25+0.2/-0	
MCASU21GSC7474□TCA01	UMK212 C7474□GHTE	50	X7S	0.47 μ	±10, ±20	3.5	150		1.25±0.10	
MCASU21GCC7684□TCA01	UMK212CC7684□GHTE	50	X7S	0.68 μ	±10, ±20	3.5	150		1.25+0.25/-0	
MCASU21GSB7105□TNA01	UMK212 B7105□GHT	50	X7R	1 μ	±10, ±20	10	150		1.25±0.10	
MCASG21GSB7224□TNA01	GMK212 B7224□GHT	35	X7R	0.22 μ	±10, ±20	3.5	150		1.25±0.10	
MCASG21GSB7105□TNA01	GMK212 B7105□GHT	35	X7R	1 μ	±10, ±20	10	150		1.25±0.10	
MCAST21GSB7224□TNA01	TMK212 B7224□GHT	25	X7R	0.22 μ	±10, ±20	3.5	150		1.25±0.10	
MCAST21GSB7334□TNA01	TMK212 B7334□GHT	25	X7R	0.33 μ	±10, ±20	3.5	200		1.25±0.10	
MCAST21GSB7474□TNA01	TMK212 B7474□GHT	25	X7R	0.47 μ	±10, ±20	3.5	150		1.25±0.10	
MCAST21GSB7105□TNB25	TMK212 B7105□GHTR	25	X7R	1 μ	±10, ±20	10	150		1.25±0.10	
MCAST21GSB7225□TNA01	TMK212 B7225□GHT	25	X7R	2.2 μ	±10, ±20	10	150		1.25±0.10	
MCASE21GSB7224□TNA01	EMK212 B7224□GHT	16	X7R	0.22 μ	±10, ±20	3.5	200		1.25±0.10	
MCASE21GSB7334□TNA01	EMK212 B7334□GHT	16	X7R	0.33 μ	±10, ±20	3.5	200		1.25±0.10	
MCASE21GSB7474□TNA01	EMK212 B7474□GHT	16	X7R	0.47 μ	±10, ±20	3.5	200		1.25±0.10	
MCASE21GSB7105□TNB25	EMK212 B7105□GHTR	16	X7R	1 μ	±10, ±20	10	150		1.25±0.10	
MCASE21GSB7225□TNA01	EMK212 B7225□GHT	16	X7R	2.2 μ	±10, ±20	10	150		1.25±0.10	
MCASE21GAB7475□TNA01	EMK212AB7475□GHT	16	X7R	4.7 μ	±10, ±20	10	150		1.25+0.15/-0.05	
MCASL21GSB7105□TNB25	LMK212 B7105□GHTR	10	X7R	1 μ	±10, ±20	10	150		1.25±0.10	
MCASL21GSB7225□TNA01	LMK212 B7225□GHT	10	X7R	2.2 μ	±10, ±20	10	150		1.25±0.10	
MCASL21GSB7475□TNA01	LMK212 B7475□GHT	10	X7R	4.7 μ	±10, ±20	10	150		1.25±0.10	
MCASL21GGB7106□TNA01	LMK212BB7106□GHTR	10	X7R	10 μ	±10, ±20	10	150		1.25+0.2/-0	
MCASJ21GSB7475□TNA01	JMK212 B7475□GHT	6.3	X7R	4.7 μ	±10, ±20	10	150		1.25±0.10	
MCASJ21GAB7106□TNA01	JMK212AB7106□GHT	6.3	X7R	10 μ	±10, ±20	10	150		1.25+0.15/-0.05	

● 3216TYPE

【Temperature Characteristic B5 (BJ) : X5R(-55~+85°C)】 1.6mm Thickness

New part number	Old part number (for reference)	Rated voltage [V]	Temperature characteristics	Capacitance [F]	Capacitance tolerance [%]	tan δ [%]	HTLT		Thickness*1 [mm]	Note
							Rated voltage x %			
MCASU31LSB5474□TNA01	UMK316 BJ474□LHT	50	X5R	0.47 μ	±10, ±20	3.5	200		1.6±0.20	
MCASU31LSB5105□TNA01	UMK316 BJ105□LHT	50	X5R	1 μ	±10, ±20	3.5	200		1.6±0.20	
MCASU31LSB5225□TNA01	UMK316 BJ225□LHT	50	X5R	2.2 μ	±10, ±20	10	150		1.6±0.20	
MCASU31LAB5475□TNA01	UMK316ABJ475□LHT	50	X5R	4.7 μ	±10, ±20	10	150		1.6±0.20	
MCASG31LSB5105□TNA01	GMK316 BJ105□LHT	35	X5R	1 μ	±10, ±20	3.5	200		1.6±0.20	
MCASG31LSB5225□TNA01	GMK316 BJ225□LHT	35	X5R	2.2 μ	±10, ±20	10	150		1.6±0.20	
MCASG31LSB5475□TNA01	GMK316 BJ475□LHT	35	X5R	4.7 μ	±10, ±20	10	150		1.6±0.20	
MCASG31LBB5106□TNA01	GMK316BBJ106□LHT	35	X5R	10 μ	±10, ±20	10	150		1.6±0.30	
MCAST31LSB5225□TNA01	TMK316 BJ225□LHT	25	X5R	2.2 μ	±10, ±20	3.5	200		1.6±0.20	
MCAST31LSB5475□TNA01	TMK316 BJ475□LHT	25	X5R	4.7 μ	±10, ±20	5	150		1.6±0.20	
MCAST31LSB5106□TNA01	TMK316 BJ106□LHT	25	X5R	10 μ	±10, ±20	5	150		1.6±0.20	
MCASE31LSB5225□TNA01	EMK316 BJ225□LHT	16	X5R	2.2 μ	±10, ±20	3.5	200		1.6±0.20	
MCASE31LSB5475□TNA01	EMK316 BJ475□LHT	16	X5R	4.7 μ	±10, ±20	5	150		1.6±0.20	
MCASE31LSB5106□TNA01	EMK316 BJ106□LHT	16	X5R	10 μ	±10, ±20	5	150		1.6±0.20	
MCASE31LBB5226MTNA01	EMK316BBJ226MLHT	16	X5R	22 μ	±20	10	150		1.6±0.30	
MCASL31LSB5475□TNA01	LMK316 BJ475□LHT	10	X5R	4.7 μ	±10, ±20	5	150		1.6±0.20	
MCASL31LSB5106□TNA01	LMK316 BJ106□LHT	10	X5R	10 μ	±10, ±20	5	150		1.6±0.20	
MCASL31LAB5226□TNA01	LMK316ABJ226□LHT	10	X5R	22 μ	±10, ±20	10	150		1.6±0.20	
MCASJ31LSB5106□TNA01	JMK316 BJ106□LHT	6.3	X5R	10 μ	±10, ±20	5	200		1.6±0.20	
MCASJ31LAB5226□TNA01	JMK316ABJ226□LHT	6.3	X5R	22 μ	±10, ±20	10	150		1.6±0.20	
MCASJ31LAB5476MTNA01	JMK316ABJ476MLHT	6.3	X5R	47 μ	±20	10	150		1.6±0.20	

PART NUMBER

【Temperature Characteristic B7 : X7R(-55~+125°C), C7 : X7S(-55~+125°C)】 1.6mm Thickness

New part number	Old part number (for reference)	Rated voltage [V]	Temperature characteristics	Capacitance [F]	Capacitance tolerance [%]	tan δ [%]	HTLT	Thickness*1 [mm]	Note
							Rated voltage x %		
MCASU31LSB7473□TNA01	UMK316 B7473□LHT	50	X7R	0.047 μ	±10, ±20	3.5	200	1.6±0.20	
MCASU31LSB7683□TNA01	UMK316 B7683□LHT	50	X7R	0.068 μ	±10, ±20	2.5	200	1.6±0.20	
MCASU31LSB7104□TNA01	UMK316 B7104□LHT	50	X7R	0.1 μ	±10, ±20	3.5	200	1.6±0.20	
MCASU31LSB7154□TNA01	UMK316 B7154□LHT	50	X7R	0.15 μ	±10, ±20	3.5	200	1.6±0.20	
MCASU31LSB7224□TNA01	UMK316 B7224□LHT	50	X7R	0.22 μ	±10, ±20	3.5	200	1.6±0.20	
MCASU31LSB7334□TNA01	UMK316 B7334□LHT	50	X7R	0.33 μ	±10, ±20	3.5	200	1.6±0.20	
MCASU31LSB7474□TNA01	UMK316 B7474□LHT	50	X7R	0.47 μ	±10, ±20	3.5	200	1.6±0.20	
MCASU31LSB7105□TNA01	UMK316 B7105□LHT	50	X7R	1 μ	±10, ±20	3.5	200	1.6±0.20	
MCASU31LBC7155□TCA01	UMK316BC7155□LHTE	50	X7S	1.5 μ	±10, ±20	3.5	150	1.6±0.30	
MCASU31LSB7225□TNA01	UMK316 B7225□LHT	50	X7R	2.2 μ	±10, ±20	10	150	1.6±0.20	
MCASU31LAC7475□TCA01	UMK316AC7475□LHTE	50	X7S	4.7 μ	±10, ±20	2.5	150	1.6±0.20	
MCASG31LSB7105□TNA01	GMK316 B7105□LHT	35	X7R	1 μ	±10, ±20	3.5	200	1.6±0.20	
MCASG31LSB7225□TNA01	GMK316 B7225□LHT	35	X7R	2.2 μ	±10, ±20	10	150	1.6±0.20	
MCASG31LAB7475□TNA01	GMK316AB7475□LHT	35	X7R	4.7 μ	±10, ±20	10	150	1.6±0.20	
MCAS31LSB7105□TNA01	TMK316 B7105□LHT	25	X7R	1 μ	±10, ±20	3.5	200	1.6±0.20	
MCAS31LSB7225□TNA01	TMK316 B7225□LHT	25	X7R	2.2 μ	±10, ±20	3.5	200	1.6±0.20	
MCAS31LAB7475□TNA01	TMK316AB7475□LHT	25	X7R	4.7 μ	±10, ±20	10	150	1.6±0.20	
MCAS31LAB7106□TNA01	TMK316AB7106□LHT	25	X7R	10 μ	±10, ±20	10	150	1.6±0.20	
MCASE31LSB7225□TNA01	EMK316 B7225□LHT	16	X7R	2.2 μ	±10, ±20	3.5	200	1.6±0.20	
MCASE31LAB7475□TNA01	EMK316AB7475□LHT	16	X7R	4.7 μ	±10, ±20	10	150	1.6±0.20	
MCASE31LAB7106□TNA01	EMK316AB7106□LHT	16	X7R	10 μ	±10, ±20	10	150	1.6±0.20	
MCASL31LSB7475□TNA01	LMK316 B7475□LHT	10	X7R	4.7 μ	±10, ±20	5	150	1.6±0.20	
MCASL31LAB7106□TNA01	LMK316AB7106□LHT	10	X7R	10 μ	±10, ±20	10	150	1.6±0.20	
MCASJ31LAB7106□TNA01	JMK316AB7106□LHT	6.3	X7R	10 μ	±10, ±20	10	150	1.6±0.20	
MCASJ31LAB7226□TNA01	JMK316AB7226□LHT	6.3	X7R	22 μ	±10, ±20	10	150	1.6±0.20	
MCASA31LAB7226□TNA01	AMK316AB7226□LHT	4	X7R	22 μ	±10, ±20	10	150	1.6±0.20	
MCASA31LAC7476MTNA01	AMK316AC7476MLHT	4	X7S	47 μ	±20	10	150	1.6±0.20	

3225TYPE

【Temperature Characteristic B5(BJ) : X5R(-55~+85°C)】 2.5mm Thickness

New part number	Old part number (for reference)	Rated voltage [V]	Temperature characteristics	Capacitance [F]	Capacitance tolerance [%]	tan δ [%]	HTLT	Thickness*1 [mm]	Note
							Rated voltage x %		
MCASU32MSB5106□PNA01	UMK325 B5106□MHP	50	X5R	10 μ	±10, ±20	5	150	2.5±0.20	
MCASG32MSB5106□PNA01	GMK325 B5106□MHP	35	X5R	10 μ	±10, ±20	5	150	2.5±0.20	
MCAS32MSB5106□PNA01	TMK325 B5106□MHP	25	X5R	10 μ	±10, ±20	5	150	2.5±0.20	
MCASE32MSB5226□PNA01	EMK325 B5226□MHP	16	X5R	22 μ	±10, ±20	5	150	2.5±0.20	
MCASE32MAB5476□PNDT1	EMK325AB5476□MHP	16	X5R	47 μ	±10, ±20	10	150	2.5±0.30	
MCASL32MSB5226□PNA01	LMK325 B5226□MHP	10	X5R	22 μ	±10, ±20	5	150	2.5±0.20	
MCASL32MAB5476□PNA01	LMK325 B5476□MHP	10	X5R	47 μ	±10, ±20	10	150	2.5±0.20	
MCASJ32MSB5476□PNA01	JMK325 B5476□MHP	6.3	X5R	47 μ	±10, ±20	10	150	2.5±0.20	

【Temperature Characteristic B5(BJ) : X5R(-55~+85°C)】 1.9mm Thickness

New part number	Old part number (for reference)	Rated voltage [V]	Temperature characteristics	Capacitance [F]	Capacitance tolerance [%]	tan δ [%]	HTLT	Thickness*1 [mm]	Note
							Rated voltage x %		
MCASU32NSB5475□TNA01	UMK325 B5475□NHT	50	X5R	4.7 μ	±10, ±20	10	150	1.9±0.20	
MCASG32NSB5225MTNA01	GMK325 B5225MNHT	35	X5R	2.2 μ	±20	3.5	200	1.9±0.20	
MCASG32NSB5475□TNA01	GMK325 B5475□NHT	35	X5R	4.7 μ	±10, ±20	10	150	1.9±0.20	
MCAS32NSB5475□TNA01	TMK325 B5475□NHT	25	X5R	4.7 μ	±10, ±20	10	150	1.9±0.20	
MCASE32NSB5475MTNA01	EMK325 B5475MNHT	16	X5R	4.7 μ	±20	3.5	200	1.9±0.20	
MCASE32NSB5106□TNA01	EMK325 B5106□NHT	16	X5R	10 μ	±10, ±20	5	150	1.9±0.20	

【Temperature Characteristic B7 : X7R(-55~+125°C)】 2.5mm Thickness

New part number	Old part number (for reference)	Rated voltage [V]	Temperature characteristics	Capacitance [F]	Capacitance tolerance [%]	tan δ [%]	HTLT	Thickness*1 [mm]	Note
							Rated voltage x %		
MCASU32MSB7225□PNA01	UMK325 B7225□MHP	50	X7R	2.2 μ	±10, ±20	3.5	200	2.5±0.20	
MCASU32MSB7335□PNA01	UMK325 B7335□MHP	50	X7R	3.3 μ	±10, ±20	3.5	200	2.5±0.20	
MCASU32MSB7475□PNA01	UMK325 B7475□MHP	50	X7R	4.7 μ	±10, ±20	5	150	2.5±0.20	
MCASU32MAB7106□PNA01	UMK325AB7106□MHP	50	X7R	10 μ	±10, ±20	10	150	2.5±0.30	
MCASG32MAB7106□PNA01	GMK325AB7106□MHP	35	X7R	10 μ	±10, ±20	10	150	2.5±0.30	
MCAS32MSB7335□PNA01	TMK325 B7335□MHP	25	X7R	3.3 μ	±10, ±20	3.5	200	2.5±0.20	
MCAS32MAB7106□PNB25	TMK325AB7106□MHPR	25	X7R	10 μ	±10, ±20	10	150	2.5±0.30	
MCAS32MSB7226□PNA01	TMK325 B7226□MHP	25	X7R	22 μ	±10, ±20	10	150	2.5±0.20	
MCASE32MSB7226□PNA01	EMK325 B7226□MHP	16	X7R	22 μ	±10, ±20	10	150	2.5±0.20	
MCASL32MSB7226□PNA01	LMK325 B7226□MHP	10	X7R	22 μ	±10, ±20	10	150	2.5±0.20	
MCASJ32MSB7226□PNB25	JMK325 B7226□MHPR	6.3	X7R	22 μ	±10, ±20	10	150	2.5±0.20	
MCASJ32MSB7476□PNB25	JMK325 B7476□MHPR	6.3	X7R	47 μ	±10, ±20	10	150	2.5±0.20	

【Temperature Characteristic B7 : X7R(-55~+125°C)】 1.9mm Thickness

New part number	Old part number (for reference)	Rated voltage [V]	Temperature characteristics	Capacitance [F]	Capacitance tolerance [%]	tan δ [%]	HTLT	Thickness*1 [mm]	Note
							Rated voltage x %		
MCASU32NSB7105□TNA01	UMK325 B7105□NHT	50	X7R	1 μ	±10, ±20	3.5	200	1.9±0.20	
MCASG32NSB7225□TNA01	GMK325 B7225□NHT	35	X7R	2.2 μ	±10, ±20	3.5	200	1.9±0.20	
MCASG32NSB7475□TNB25	GMK325 B7475□NHTR	35	X7R	4.7 μ	±10, ±20	10	150	1.9±0.20	
MCAS32NSB7475□TNA01	TMK325 B7475□NHT	25	X7R	4.7 μ	±10, ±20	10	150	1.9±0.20	
MCASE32NSB7475□TNA01	EMK325 B7475□NHT	16	X7R	4.7 μ	±10, ±20	3.5	150	1.9±0.20	
MCASE32NSB7106□TNB25	EMK325 B7106□NHTR	16	X7R	10 μ	±10, ±20	10	150	1.9±0.20	

PART NUMBER

Multilayer Ceramic Capacitors (Temperature compensating type) for Automotive Body & Chassis and Infotainment

0603TYPE

【Temperature Characteristic C Δ : C Δ /C0 Δ (-55~+125°C)】 0.3mm Thickness

New part number	Old part number (for reference)	Rated voltage [V]	Temperature characteristics	Capacitance [F]	Capacitance tolerance	Q [at 1MHz] (Min)	HTLT	Thickness*1 [mm]	Note
							Rated voltage x %		
MCASU063SCK0R5CFNA01	UMK063 CK0R5CTHF	50	CK C0K	0.5 p	±0.25pF	410	200	0.3±0.03	
MCASU063SCK010CFNA01	UMK063 CK010CTHF	50	CK C0K	1 p	±0.25pF	420	200	0.3±0.03	
MCASU063SCK1R5CFNA01	UMK063 CK1R5CTHF	50	CK C0K	1.5 p	±0.25pF	430	200	0.3±0.03	
MCASU063SCK020CFNA01	UMK063 CK020CTHF	50	CK C0K	2 p	±0.25pF	440	200	0.3±0.03	
MCASU063SCJ030CFNA01	UMK063 CJ030CTHF	50	CJ C0J	3 p	±0.25pF	460	200	0.3±0.03	
MCASU063SCH040CFNA01	UMK063 CH040CTHF	50	CH C0H	4 p	±0.25pF	480	200	0.3±0.03	
MCASU063SCH050CFNA01	UMK063 CH050CTHF	50	CH C0H	5 p	±0.25pF	500	200	0.3±0.03	
MCASU063SCH060DFNA01	UMK063 CH060DTHF	50	CH C0H	6 p	±0.5pF	520	200	0.3±0.03	
MCASU063SCH070DFNA01	UMK063 CH070DTHF	50	CH C0H	7 p	±0.5pF	540	200	0.3±0.03	
MCASU063SCH080DFNA01	UMK063 CH080DTHF	50	CH C0H	8 p	±0.5pF	560	200	0.3±0.03	
MCASU063SCH090DFNA01	UMK063 CH090DTHF	50	CH C0H	9 p	±0.5pF	580	200	0.3±0.03	
MCASU063SCH100DFNA01	UMK063 CH100DTHF	50	CH C0H	10 p	±0.5pF	600	200	0.3±0.03	
MCASU063SCH120JFNA01	UMK063 CH120JTHF	50	CH C0H	12 p	±5%	640	200	0.3±0.03	
MCASU063SCH150JFNA01	UMK063 CH150JTHF	50	CH C0H	15 p	±5%	700	200	0.3±0.03	
MCASU063SCH180JFNA01	UMK063 CH180JTHF	50	CH C0H	18 p	±5%	760	200	0.3±0.03	
MCASU063SCH220JFNA01	UMK063 CH220JTHF	50	CH C0H	22 p	±5%	840	200	0.3±0.03	
MCASU063SCH270JFNA01	UMK063 CH270JTHF	50	CH C0H	27 p	±5%	940	200	0.3±0.03	
MCASU063SCH330JFNA01	UMK063 CH330JTHF	50	CH C0H	33 p	±5%	1000	200	0.3±0.03	
MCASU063SCH390JFNA01	UMK063 CH390JTHF	50	CH C0H	39 p	±5%	1000	200	0.3±0.03	
MCASU063SCH470JFNA01	UMK063 CH470JTHF	50	CH C0H	47 p	±5%	1000	200	0.3±0.03	
MCASU063SCH560JFNA01	UMK063 CH560JTHF	50	CH C0H	56 p	±5%	1000	200	0.3±0.03	
MCASU063SCH680JFNA01	UMK063 CH680JTHF	50	CH C0H	68 p	±5%	1000	200	0.3±0.03	
MCASU063SCH820JFNA01	UMK063 CH820JTHF	50	CH C0H	82 p	±5%	1000	200	0.3±0.03	
MCASU063SCH101JFNA01	UMK063 CH101JTHF	50	CH C0H	100 p	±5%	1000	200	0.3±0.03	
MCASU063SCH121JFNA01	UMK063 CH121JTHF	50	CH C0H	120 p	±5%	1000	200	0.3±0.03	
MCASU063SCH151JFNA01	UMK063 CH151JTHF	50	CH C0H	150 p	±5%	1000	200	0.3±0.03	
MCASU063SCH181JFNA01	UMK063 CH181JTHF	50	CH C0H	180 p	±5%	1000	200	0.3±0.03	
MCASU063SCH221JFNA01	UMK063 CH221JTHF	50	CH C0H	220 p	±5%	1000	200	0.3±0.03	
MCASU063SCH121JFNA01	TMK063 CH121JTHF	25	CH C0H	120 p	±5%	1000	200	0.3±0.03	
MCASU063SCH151JFNA01	TMK063 CH151JTHF	25	CH C0H	150 p	±5%	1000	200	0.3±0.03	
MCASU063SCH181JFNA01	TMK063 CH181JTHF	25	CH C0H	180 p	±5%	1000	200	0.3±0.03	
MCASU063SCH221JFNA01	TMK063 CH221JTHF	25	CH C0H	220 p	±5%	1000	200	0.3±0.03	
MCASU063SCG0R5CFNA01	UMK063 CG0R5CTHF	50	CG C0G	0.5 p	±0.25pF	410	200	0.3±0.03	
MCASU063SCG010CFNA01	UMK063 CG010CTHF	50	CG C0G	1 p	±0.25pF	420	200	0.3±0.03	
MCASU063SCG1R5CFNA01	UMK063 CG1R5CTHF	50	CG C0G	1.5 p	±0.25pF	430	200	0.3±0.03	
MCASU063SCG020CFNA01	UMK063 CG020CTHF	50	CG C0G	2 p	±0.25pF	440	200	0.3±0.03	
MCASU063SCG030CFNA01	UMK063 CG030CTHF	50	CG C0G	3 p	±0.25pF	460	200	0.3±0.03	
MCASU063SCG040CFNA01	UMK063 CG040CTHF	50	CG C0G	4 p	±0.25pF	480	200	0.3±0.03	
MCASU063SCG050CFNA01	UMK063 CG050CTHF	50	CG C0G	5 p	±0.25pF	500	200	0.3±0.03	
MCASU063SCG060DFNA01	UMK063 CG060DTHF	50	CG C0G	6 p	±0.5pF	520	200	0.3±0.03	
MCASU063SCG070DFNA01	UMK063 CG070DTHF	50	CG C0G	7 p	±0.5pF	540	200	0.3±0.03	
MCASU063SCG080DFNA01	UMK063 CG080DTHF	50	CG C0G	8 p	±0.5pF	560	200	0.3±0.03	
MCASU063SCG090DFNA01	UMK063 CG090DTHF	50	CG C0G	9 p	±0.5pF	580	200	0.3±0.03	
MCASU063SCG100DFNA01	UMK063 CG100DTHF	50	CG C0G	10 p	±0.5pF	600	200	0.3±0.03	
MCASU063SCG120JFNA01	UMK063 CG120JTHF	50	CG C0G	12 p	±5%	640	200	0.3±0.03	
MCASU063SCG150JFNA01	UMK063 CG150JTHF	50	CG C0G	15 p	±5%	700	200	0.3±0.03	
MCASU063SCG180JFNA01	UMK063 CG180JTHF	50	CG C0G	18 p	±5%	760	200	0.3±0.03	
MCASU063SCG220JFNA01	UMK063 CG220JTHF	50	CG C0G	22 p	±5%	840	200	0.3±0.03	
MCASU063SCG270JFNA01	UMK063 CG270JTHF	50	CG C0G	27 p	±5%	940	200	0.3±0.03	
MCASU063SCG330JFNA01	UMK063 CG330JTHF	50	CG C0G	33 p	±5%	1000	200	0.3±0.03	
MCASU063SCG390JFNA01	UMK063 CG390JTHF	50	CG C0G	39 p	±5%	1000	200	0.3±0.03	
MCASU063SCG470JFNA01	UMK063 CG470JTHF	50	CG C0G	47 p	±5%	1000	200	0.3±0.03	
MCASU063SCG560JFNA01	UMK063 CG560JTHF	50	CG C0G	56 p	±5%	1000	200	0.3±0.03	
MCASU063SCG680JFNA01	UMK063 CG680JTHF	50	CG C0G	68 p	±5%	1000	200	0.3±0.03	
MCASU063SCG820JFNA01	UMK063 CG820JTHF	50	CG C0G	82 p	±5%	1000	200	0.3±0.03	
MCASU063SCG101JFNA01	UMK063 CG101JTHF	50	CG C0G	100 p	±5%	1000	200	0.3±0.03	
MCASU063SCG121JFNA01	UMK063 CG121JTHF	50	CG C0G	120 p	±5%	1000	200	0.3±0.03	
MCASU063SCG151JFNA01	UMK063 CG151JTHF	50	CG C0G	150 p	±5%	1000	200	0.3±0.03	
MCASU063SCG181JFNA01	UMK063 CG181JTHF	50	CG C0G	180 p	±5%	1000	200	0.3±0.03	
MCASU063SCG221JFNA01	UMK063 CG221JTHF	50	CG C0G	220 p	±5%	1000	200	0.3±0.03	
MCASU063SCG121JFNA01	TMK063 CG121JTHF	25	CG C0G	120 p	±5%	1000	200	0.3±0.03	
MCASU063SCG151JFNA01	TMK063 CG151JTHF	25	CG C0G	150 p	±5%	1000	200	0.3±0.03	
MCASU063SCG181JFNA01	TMK063 CG181JTHF	25	CG C0G	180 p	±5%	1000	200	0.3±0.03	
MCASU063SCG221JFNA01	TMK063 CG221JTHF	25	CG C0G	220 p	±5%	1000	200	0.3±0.03	

■ PART NUMBER

● 1005TYPE

【Temperature Characteristic CΔ : CΔ/C0Δ (-55~+125°C)】 0.5mm Thickness

New part number	Old part number (for reference)	Rated voltage [V]	Temperature characteristics		Capacitance [F]	Capacitance tolerance	Q [at 1MHz] (Min)	HTLT	Thickness*1 [mm]	Note
								Rated voltage x %		
MCASU105SCK0R5CFNA01	UMK105 CK0R5CVHF	50	CK	C0K	0.5 p	±0.25pF	410	200	0.5±0.05	
MCASU105SCK010CFNA01	UMK105 CK010CVHF	50	CK	C0K	1 p	±0.25pF	420	200	0.5±0.05	
MCASU105SCK1R5CFNA01	UMK105 CK1R5CVHF	50	CK	C0K	1.5 p	±0.25pF	430	200	0.5±0.05	
MCASU105SCK020CFNA01	UMK105 CK020CVHF	50	CK	C0K	2 p	±0.25pF	440	200	0.5±0.05	
MCASU105SCH030CFNA01	UMK105 CJ030CVHF	50	CJ	C0J	3 p	±0.25pF	460	200	0.5±0.05	
MCASU105SCH040CFNA01	UMK105 CH040CVHF	50	CH	C0H	4 p	±0.25pF	480	200	0.5±0.05	
MCASU105SCH050CFNA01	UMK105 CH050CVHF	50	CH	C0H	5 p	±0.25pF	500	200	0.5±0.05	
MCASU105SCH060DFNA01	UMK105 CH060DVHF	50	CH	C0H	6 p	±0.5pF	520	200	0.5±0.05	
MCASU105SCH070DFNA01	UMK105 CH070DVHF	50	CH	C0H	7 p	±0.5pF	540	200	0.5±0.05	
MCASU105SCH080DFNA01	UMK105 CH080DVHF	50	CH	C0H	8 p	±0.5pF	560	200	0.5±0.05	
MCASU105SCH090DFNA01	UMK105 CH090DVHF	50	CH	C0H	9 p	±0.5pF	580	200	0.5±0.05	
MCASU105SCH100DFNA01	UMK105 CH100DVHF	50	CH	C0H	10 p	±0.5pF	600	200	0.5±0.05	
MCASU105SCH120JFNA01	UMK105 CH120JVHF	50	CH	C0H	12 p	±5%	640	200	0.5±0.05	
MCASU105SCH150JFNA01	UMK105 CH150JVHF	50	CH	C0H	15 p	±5%	700	200	0.5±0.05	
MCASU105SCH180JFNA01	UMK105 CH180JVHF	50	CH	C0H	18 p	±5%	760	200	0.5±0.05	
MCASU105SCH220JFNA01	UMK105 CH220JVHF	50	CH	C0H	22 p	±5%	840	200	0.5±0.05	
MCASU105SCH270JFNA01	UMK105 CH270JVHF	50	CH	C0H	27 p	±5%	940	200	0.5±0.05	
MCASU105SCH330JFNA01	UMK105 CH330JVHF	50	CH	C0H	33 p	±5%	1000	200	0.5±0.05	
MCASU105SCH390JFNA01	UMK105 CH390JVHF	50	CH	C0H	39 p	±5%	1000	200	0.5±0.05	
MCASU105SCH470JFNA01	UMK105 CH470JVHF	50	CH	C0H	47 p	±5%	1000	200	0.5±0.05	
MCASU105SCH560JFNA01	UMK105 CH560JVHF	50	CH	C0H	56 p	±5%	1000	200	0.5±0.05	
MCASU105SCH680JFNA01	UMK105 CH680JVHF	50	CH	C0H	68 p	±5%	1000	200	0.5±0.05	
MCASU105SCH820JFNA01	UMK105 CH820JVHF	50	CH	C0H	82 p	±5%	1000	200	0.5±0.05	
MCASU105SCH101JFNA01	UMK105 CH101JVHF	50	CH	C0H	100 p	±5%	1000	200	0.5±0.05	
MCASU105SCH121JFNA01	UMK105 CH121JVHF	50	CH	C0H	120 p	±5%	1000	200	0.5±0.05	
MCASU105SCH151JFNA01	UMK105 CH151JVHF	50	CH	C0H	150 p	±5%	1000	200	0.5±0.05	
MCASU105SCH181JFNA01	UMK105 CH181JVHF	50	CH	C0H	180 p	±5%	1000	200	0.5±0.05	
MCASU105SCH221JFNA01	UMK105 CH221JVHF	50	CH	C0H	220 p	±5%	1000	200	0.5±0.05	
MCASU105SCH271JFNA01	UMK105 CH271JVHF	50	CH	C0H	270 p	±5%	1000	200	0.5±0.05	
MCASU105SCH331JFNA01	UMK105 CH331JVHF	50	CH	C0H	330 p	±5%	1000	200	0.5±0.05	
MCASU105SCH391JFNA01	UMK105 CH391JVHF	50	CH	C0H	390 p	±5%	1000	200	0.5±0.05	
MCASU105SCH471JFNA01	UMK105 CH471JVHF	50	CH	C0H	470 p	±5%	1000	200	0.5±0.05	
MCASU105SCH561JFNA01	UMK105 CH561JVHF	50	CH	C0H	560 p	±5%	1000	200	0.5±0.05	
MCASU105SCH681JFNA01	UMK105 CH681JVHF	50	CH	C0H	680 p	±5%	1000	200	0.5±0.05	
MCASU105SCH821JFNA01	UMK105 CH821JVHF	50	CH	C0H	820 p	±5%	1000	200	0.5±0.05	
MCASU105SCH102JFNA01	UMK105 CH102JVHF	50	CH	C0H	1000 p	±5%	1000	200	0.5±0.05	
MCASU105SCG0R5CFNA01	UMK105 CG0R5CVHF	50	CG	C0G	0.5 p	±0.25pF	410	200	0.5±0.05	
MCASU105SCG010CFNA01	UMK105 CG010CVHF	50	CG	C0G	1 p	±0.25pF	420	200	0.5±0.05	
MCASU105SCG1R5CFNA01	UMK105 CG1R5CVHF	50	CG	C0G	1.5 p	±0.25pF	430	200	0.5±0.05	
MCASU105SCG020CFNA01	UMK105 CG020CVHF	50	CG	C0G	2 p	±0.25pF	440	200	0.5±0.05	
MCASU105SCG030CFNA01	UMK105 CG030CVHF	50	CG	C0G	3 p	±0.25pF	460	200	0.5±0.05	
MCASU105SCG040CFNA01	UMK105 CG040CVHF	50	CG	C0G	4 p	±0.25pF	480	200	0.5±0.05	
MCASU105SCG050CFNA01	UMK105 CG050CVHF	50	CG	C0G	5 p	±0.25pF	500	200	0.5±0.05	
MCASU105SCG060DFNA01	UMK105 CG060DVHF	50	CG	C0G	6 p	±0.5pF	520	200	0.5±0.05	
MCASU105SCG070DFNA01	UMK105 CG070DVHF	50	CG	C0G	7 p	±0.5pF	540	200	0.5±0.05	
MCASU105SCG080DFNA01	UMK105 CG080DVHF	50	CG	C0G	8 p	±0.5pF	560	200	0.5±0.05	
MCASU105SCG090DFNA01	UMK105 CG090DVHF	50	CG	C0G	9 p	±0.5pF	580	200	0.5±0.05	
MCASU105SCG100DFNA01	UMK105 CG100DVHF	50	CG	C0G	10 p	±0.5pF	600	200	0.5±0.05	
MCASU105SCG120JFNA01	UMK105 CG120JVHF	50	CG	C0G	12 p	±5%	640	200	0.5±0.05	
MCASU105SCG150JFNA01	UMK105 CG150JVHF	50	CG	C0G	15 p	±5%	700	200	0.5±0.05	
MCASU105SCG180JFNA01	UMK105 CG180JVHF	50	CG	C0G	18 p	±5%	760	200	0.5±0.05	
MCASU105SCG220JFNA01	UMK105 CG220JVHF	50	CG	C0G	22 p	±5%	840	200	0.5±0.05	
MCASU105SCG270JFNA01	UMK105 CG270JVHF	50	CG	C0G	27 p	±5%	940	200	0.5±0.05	
MCASU105SCG330JFNA01	UMK105 CG330JVHF	50	CG	C0G	33 p	±5%	1000	200	0.5±0.05	
MCASU105SCG390JFNA01	UMK105 CG390JVHF	50	CG	C0G	39 p	±5%	1000	200	0.5±0.05	
MCASU105SCG470JFNA01	UMK105 CG470JVHF	50	CG	C0G	47 p	±5%	1000	200	0.5±0.05	
MCASU105SCG560JFNA01	UMK105 CG560JVHF	50	CG	C0G	56 p	±5%	1000	200	0.5±0.05	
MCASU105SCG680JFNA01	UMK105 CG680JVHF	50	CG	C0G	68 p	±5%	1000	200	0.5±0.05	
MCASU105SCG820JFNA01	UMK105 CG820JVHF	50	CG	C0G	82 p	±5%	1000	200	0.5±0.05	
MCASU105SCG101JFNA01	UMK105 CG101JVHF	50	CG	C0G	100 p	±5%	1000	200	0.5±0.05	
MCASU105SCG121JFNA01	UMK105 CG121JVHF	50	CG	C0G	120 p	±5%	1000	200	0.5±0.05	
MCASU105SCG151JFNA01	UMK105 CG151JVHF	50	CG	C0G	150 p	±5%	1000	200	0.5±0.05	
MCASU105SCG181JFNA01	UMK105 CG181JVHF	50	CG	C0G	180 p	±5%	1000	200	0.5±0.05	
MCASU105SCG221JFNA01	UMK105 CG221JVHF	50	CG	C0G	220 p	±5%	1000	200	0.5±0.05	
MCASU105SCG271JFNA01	UMK105 CG271JVHF	50	CG	C0G	270 p	±5%	1000	200	0.5±0.05	
MCASU105SCG331JFNA01	UMK105 CG331JVHF	50	CG	C0G	330 p	±5%	1000	200	0.5±0.05	
MCASU105SCG391JFNA01	UMK105 CG391JVHF	50	CG	C0G	390 p	±5%	1000	200	0.5±0.05	
MCASU105SCG471JFNA01	UMK105 CG471JVHF	50	CG	C0G	470 p	±5%	1000	200	0.5±0.05	
MCASU105SCG561JFNA01	UMK105 CG561JVHF	50	CG	C0G	560 p	±5%	1000	200	0.5±0.05	
MCASU105SCG681JFNA01	UMK105 CG681JVHF	50	CG	C0G	680 p	±5%	1000	200	0.5±0.05	
MCASU105SCG821JFNA01	UMK105 CG821JVHF	50	CG	C0G	820 p	±5%	1000	200	0.5±0.05	
MCASU105SCG102JFNA01	UMK105 CG102JVHF	50	CG	C0G	1000 p	±5%	1000	200	0.5±0.05	

▶ This catalog contains the typical specification only due to the limitation of space. When you consider the purchase of our products, please check our specification.
For details of each product (characteristics graph, reliability information, precautions for use, and so on), see our Web site (<http://www.ty-top.com/>).

PART NUMBER

Medium-High Voltage Multilayer Ceramic Capacitors for Automotive Body & Chassis and Infotainment

1005TYPE

【Temperature Characteristic B7 : X7R(-55~+125°C), C7 : X7S(-55~+125°C)】 0.5mm Thickness

New part number	Old part number (for reference)	Rated voltage [V]	Temperature characteristics	Capacitance [F]	Capacitance tolerance [%]	tan δ [%]	HTLT	Thickness*1 [mm]	Note
							Rated voltage x %		
MCASH105SB7221[FCA01	HMK105 B7221[VHFE	100	X7R	220 p	±10, ±20	3.5	200	0.5±0.05	
MCASH105SB7331[FCA01	HMK105 B7331[VHFE	100	X7R	330 p	±10, ±20	3.5	200	0.5±0.05	
MCASH105SB7471[FCA01	HMK105 B7471[VHFE	100	X7R	470 p	±10, ±20	3.5	200	0.5±0.05	
MCASH105SB7681[FCA01	HMK105 B7681[VHFE	100	X7R	680 p	±10, ±20	3.5	200	0.5±0.05	
MCASH105SB7102[FCA01	HMK105 B7102[VHFE	100	X7R	1000 p	±10, ±20	3.5	200	0.5±0.05	
MCASH105SB7152[FCA01	HMK105 B7152[VHFE	100	X7R	1500 p	±10, ±20	3.5	200	0.5±0.05	
MCASH105SB7222[FCA01	HMK105 B7222[VHFE	100	X7R	2200 p	±10, ±20	3.5	200	0.5±0.05	
MCASH105SB7332[FCA01	HMK105 B7332[VHFE	100	X7R	3300 p	±10, ±20	3.5	200	0.5±0.05	
MCASH105SB7472[FCA01	HMK105 B7472[VHFE	100	X7R	4700 p	±10, ±20	3.5	200	0.5±0.05	
MCASH105SB7682[FCA01	HMK105 B7682[VHFE	100	X7R	6800 p	±10, ±20	3.5	200	0.5±0.05	
MCASH105SB7103[FCA01	HMK105 B7103[VHFE	100	X7R	0.01 μ	±10, ±20	3.5	200	0.5±0.05	

1608TYPE

【Temperature Characteristic B7 : X7R(-55~+125°C), C7 : X7S(-55~+125°C)】 0.8mm Thickness

New part number	Old part number (for reference)	Rated voltage [V]	Temperature characteristics	Capacitance [F]	Capacitance tolerance [%]	tan δ [%]	HTLT	Thickness*1 [mm]	Note
							Rated voltage x %		
MCASH168SB7102[TNA01	HMK107 B7102[AHT	100	X7R	1000 p	±10, ±20	3.5	200	0.8±0.10	
MCASH168SB7152[TNA01	HMK107 B7152[AHT	100	X7R	1500 p	±10, ±20	3.5	200	0.8±0.10	
MCASH168SB7222[TNA01	HMK107 B7222[AHT	100	X7R	2200 p	±10, ±20	3.5	200	0.8±0.10	
MCASH168SB7332[TNA01	HMK107 B7332[AHT	100	X7R	3300 p	±10, ±20	3.5	200	0.8±0.10	
MCASH168SB7472[TNA01	HMK107 B7472[AHT	100	X7R	4700 p	±10, ±20	3.5	200	0.8±0.10	
MCASH168SB7682[TNA01	HMK107 B7682[AHT	100	X7R	6800 p	±10, ±20	3.5	200	0.8±0.10	
MCASH168SB7103[TNA01	HMK107 B7103[AHT	100	X7R	0.01 μ	±10, ±20	3.5	200	0.8±0.10	
MCASH168SB7153[TNA01	HMK107 B7153[AHT	100	X7R	0.015 μ	±10, ±20	3.5	200	0.8±0.10	
MCASH168SB7223[TNA01	HMK107 B7223[AHT	100	X7R	0.022 μ	±10, ±20	3.5	200	0.8±0.10	
MCASH168SB7333[TNA01	HMK107 B7333[AHT	100	X7R	0.033 μ	±10, ±20	3.5	200	0.8±0.10	
MCASH168SB7473[TNA01	HMK107 B7473[AHT	100	X7R	0.047 μ	±10, ±20	3.5	200	0.8±0.10	
MCASH168AB7683[TCA01	HMK107AB7683[AHTE	100	X7R	0.068 μ	±10, ±20	3.5	200	0.8+0.15/-0.05	
MCASH168SB7104[TNA01	HMK107 B7104[AHT	100	X7R	0.1 μ	±10, ±20	3.5	200	0.8±0.10	
MCASH168AC7154[TCA01	HMK107AC7154[AHTE	100	X7S	0.15 μ	±10, ±20	3.5	150	0.8+0.15/-0.05	
MCASH168SC7224[TCA01	HMK107 C7224[AHTE	100	X7S	0.22 μ	±10, ±20	3.5	150	0.8±0.10	

2012TYPE

【Temperature Characteristic B7 : X7R(-55~+125°C), C7 : X7S(-55~+125°C)】 1.25mm Thickness

New part number	Old part number (for reference)	Rated voltage [V]	Temperature characteristics	Capacitance [F]	Capacitance tolerance [%]	tan δ [%]	HTLT	Thickness*1 [mm]	Note
							Rated voltage x %		
MCASH21GSB7472[TNA01	HMK212 B7472[GHT	100	X7R	4700 p	±10, ±20	2.5	200	1.25±0.10	
MCASH21GSB7682[TNA01	HMK212 B7682[GHT	100	X7R	6800 p	±10, ±20	2.5	200	1.25±0.10	
MCASH21GSB7103[TNA01	HMK212 B7103[GHT	100	X7R	0.01 μ	±10, ±20	3.5	200	1.25±0.10	
MCASH21GSB7153[TNA01	HMK212 B7153[GHT	100	X7R	0.015 μ	±10, ±20	3.5	200	1.25±0.10	
MCASH21GSB7223[TNA01	HMK212 B7223[GHT	100	X7R	0.022 μ	±10, ±20	3.5	200	1.25±0.10	
MCASH21GSB7333[TNA01	HMK212 B7333[GHT	100	X7R	0.033 μ	±10, ±20	3.5	200	1.25±0.10	
MCASH21GSB7473[TNA01	HMK212 B7473[GHT	100	X7R	0.047 μ	±10, ±20	3.5	200	1.25±0.10	
MCASH21GSB7683[TNA01	HMK212 B7683[GHT	100	X7R	0.068 μ	±10, ±20	3.5	200	1.25±0.10	
MCASH21GSB7104[TNA01	HMK212 B7104[GHT	100	X7R	0.1 μ	±10, ±20	3.5	200	1.25±0.10	
MCASH21GBB7154[TCA01	HMK212BB7154[GHTE	100	X7R	0.15 μ	±10, ±20	3.5	200	1.25+0.20/-0	
MCASH21GSB7224[TNA01	HMK212 B7224[GHT	100	X7R	0.22 μ	±10, ±20	3.5	200	1.25±0.10	
MCASH21GBC7334[TCA01	HMK212BC7334[GHTE	100	X7S	0.33 μ	±10, ±20	3.5	150	1.25+0.20/-0	
MCASH21GSC7474[TCA01	HMK212 C7474[GHTE	100	X7S	0.47 μ	±10, ±20	3.5	150	1.25±0.10	
MCASH21GCC7684[TCA01	HMK212CC7684[GHTE	100	X7S	0.68 μ	±10, ±20	3.5	150	1.25+0.25/-0	
MCASH21GBC7105[TCA01	HMK212BC7105[GHTE	100	X7S	1 μ	±10, ±20	3.5	150	1.25+0.20/-0	
MCASQ21GSB7472[TNA01	QMK212 B7472[GHT	250	X7R	4700 p	±10, ±20	2.5	150	1.25±0.10	
MCASQ21GSB7682[TNA01	QMK212 B7682[GHT	250	X7R	6800 p	±10, ±20	2.5	150	1.25±0.10	
MCASQ21GSB7103[TNA01	QMK212 B7103[GHT	250	X7R	0.01 μ	±10, ±20	2.5	150	1.25±0.10	
MCASQ21GSB7153[TNA01	QMK212 B7153[GHT	250	X7R	0.015 μ	±10, ±20	2.5	150	1.25±0.10	
MCASQ21GSB7223[TNA01	QMK212 B7223[GHT	250	X7R	0.022 μ	±10, ±20	2.5	150	1.25±0.10	

【Temperature Characteristic B7 : X7R(-55~+125°C)】 0.85mm Thickness

New part number	Old part number (for reference)	Rated voltage [V]	Temperature characteristics	Capacitance [F]	Capacitance tolerance [%]	tan δ [%]	HTLT	Thickness*1 [mm]	Note
							Rated voltage x %		
MCASH219SB7102[TNA01	HMK212 B7102[DHT	100	X7R	1000 p	±10, ±20	2.5	200	0.85±0.10	
MCASH219SB7152[TNA01	HMK212 B7152[DHT	100	X7R	1500 p	±10, ±20	2.5	200	0.85±0.10	
MCASH219SB7222[TNA01	HMK212 B7222[DHT	100	X7R	2200 p	±10, ±20	2.5	200	0.85±0.10	
MCASH219SB7332[TNA01	HMK212 B7332[DHT	100	X7R	3300 p	±10, ±20	2.5	200	0.85±0.10	
MCASQ219SB7102[TNA01	QMK212 B7102[DHT	250	X7R	1000 p	±10, ±20	2.5	150	0.85±0.10	
MCASQ219SB7152[TNA01	QMK212 B7152[DHT	250	X7R	1500 p	±10, ±20	2.5	150	0.85±0.10	
MCASQ219SB7222[TNA01	QMK212 B7222[DHT	250	X7R	2200 p	±10, ±20	2.5	150	0.85±0.10	
MCASQ219SB7332[TNA01	QMK212 B7332[DHT	250	X7R	3300 p	±10, ±20	2.5	150	0.85±0.10	

PART NUMBER

3216TYPE

【Temperature Characteristic B7 : X7R(-55~+125°C), C7 : X7S(-55~+125°C)】 1.6mm Thickness

New part number	Old part number (for reference)	Rated voltage [V]	Temperature characteristics	Capacitance [F]	Capacitance tolerance [%]	tan δ [%]	HTLT	Thickness*1 [mm]	Note
							Rated voltage x %		
MCASH31LSB7473□TNA01	HMK316 B7473□LHT	100	X7R	0.047 μ	±10, ±20	3.5	200	1.6±0.20	
MCASH31LSB7683□TNA01	HMK316 B7683□LHT	100	X7R	0.068 μ	±10, ±20	3.5	200	1.6±0.20	
MCASH31LSB7104□TNA01	HMK316 B7104□LHT	100	X7R	0.1 μ	±10, ±20	3.5	200	1.6±0.20	
MCASH31LSB7154□TNA01	HMK316 B7154□LHT	100	X7R	0.15 μ	±10, ±20	3.5	200	1.6±0.20	
MCASH31LSB7224□TNA01	HMK316 B7224□LHT	100	X7R	0.22 μ	±10, ±20	3.5	200	1.6±0.20	
MCASH31LSB7334□TNA01	HMK316 B7334□LHT	100	X7R	0.33 μ	±10, ±20	3.5	200	1.6±0.20	
MCASH31LSB7474□TNA01	HMK316 B7474□LHT	100	X7R	0.47 μ	±10, ±20	3.5	200	1.6±0.20	
MCASH31LSB7105□TNA01	HMK316 B7105□LHT	100	X7R	1 μ	±10, ±20	3.5	200	1.6±0.20	
MCASH31LBC7155□TCA01	HMK316BC7155□LHTE	100	X7S	1.5 μ	±10, ±20	3.5	150	1.6±0.30	
MCASH31LAC7225□TCA01	HMK316AC7225□LHTE	100	X7S	2.2 μ	±10, ±20	3.5	150	1.6±0.20	
MCASQ31LSB7223□TNA01	QMK316 B7223□LHT	250	X7R	0.022 μ	±10, ±20	2.5	150	1.6±0.20	
MCASQ31LSB7333□TNA01	QMK316 B7333□LHT	250	X7R	0.033 μ	±10, ±20	2.5	150	1.6±0.20	
MCASQ31LSB7473□TNA01	QMK316 B7473□LHT	250	X7R	0.047 μ	±10, ±20	2.5	150	1.6±0.20	
MCASQ31LSB7683□TNA01	QMK316 B7683□LHT	250	X7R	0.068 μ	±10, ±20	2.5	150	1.6±0.20	
MCASQ31LSB7104□TNA01	QMK316 B7104□LHT	250	X7R	0.1 μ	±10, ±20	2.5	150	1.6±0.20	
MCASS31LSB7153□TNA01	SMK316 B7153□LHT	630	X7R	0.015 μ	±10, ±20	2.5	120	1.6±0.20	
MCASS31LSB7223□TNA01	SMK316 B7223□LHT	630	X7R	0.022 μ	±10, ±20	2.5	120	1.6±0.20	
MCASS31LAB7333□TNA01	SMK316AB7333□LHT	630	X7R	0.033 μ	±10, ±20	2.5	120	1.6±0.20	
MCASS31LAB7473□TNA01	SMK316AB7473□LHT	630	X7R	0.047 μ	±10, ±20	2.5	120	1.6±0.20	

【Temperature Characteristic B7 : X7R(-55~+125°C)】 1.15mm Thickness

New part number	Old part number (for reference)	Rated voltage [V]	Temperature characteristics	Capacitance [F]	Capacitance tolerance [%]	tan δ [%]	HTLT	Thickness*1 [mm]	Note
							Rated voltage x %		
MCASS31QHB7102□TNA01	SMK316 B7102□FHT	630	X7R	1000 p	±10, ±20	2.5	120	1.15±0.10	
MCASS31QHB7152□TNA01	SMK316 B7152□FHT	630	X7R	1500 p	±10, ±20	2.5	120	1.15±0.10	
MCASS31QHB7222□TNA01	SMK316 B7222□FHT	630	X7R	2200 p	±10, ±20	2.5	120	1.15±0.10	
MCASS31QHB7332□TNA01	SMK316 B7332□FHT	630	X7R	3300 p	±10, ±20	2.5	120	1.15±0.10	
MCASS31QHB7472□TNA01	SMK316 B7472□FHT	630	X7R	4700 p	±10, ±20	2.5	120	1.15±0.10	
MCASS31QHB7682□TNA01	SMK316 B7682□FHT	630	X7R	6800 p	±10, ±20	2.5	120	1.15±0.10	
MCASS31QHB7103□TNA01	SMK316 B7103□FHT	630	X7R	0.01 μ	±10, ±20	2.5	120	1.15±0.10	

3225TYPE

【Temperature Characteristic B7 : X7R(-55~+125°C), C7 : X7S(-55~+125°C)】 2.5mm Thickness

New part number	Old part number (for reference)	Rated voltage [V]	Temperature characteristics	Capacitance [F]	Capacitance tolerance [%]	tan δ [%]	HTLT	Thickness*1 [mm]	Note
							Rated voltage x %		
MCASH32MSB7225□PNA01	HMK325 B7225□MHP	100	X7R	2.2 μ	±10, ±20	3.5	200	2.5±0.20	
MCASH32MSC7475□PCA01	HMK325 C7475□MHPE	100	X7S	4.7 μ	±10, ±20	3.5	150	2.5±0.20	

【Temperature Characteristic B7 : X7R(-55~+125°C)】 1.9mm Thickness

New part number	Old part number (for reference)	Rated voltage [V]	Temperature characteristics	Capacitance [F]	Capacitance tolerance [%]	tan δ [%]	HTLT	Thickness*1 [mm]	Note
							Rated voltage x %		
MCASH32NSB7224□TNA01	HMK325 B7224□NHT	100	X7R	0.22 μ	±10, ±20	3.5	200	1.9±0.20	
MCASH32NSB7474□TNA01	HMK325 B7474□NHT	100	X7R	0.47 μ	±10, ±20	3.5	200	1.9±0.20	
MCASH32NSB7684□TNA01	HMK325 B7684□NHT	100	X7R	0.68 μ	±10, ±20	3.5	200	1.9±0.20	
MCASH32NSB7105□TNA01	HMK325 B7105□NHT	100	X7R	1 μ	±10, ±20	3.5	200	1.9±0.20	
MCASQ32NSB7473□TNA01	QMK325 B7473□NHT	250	X7R	0.047 μ	±10, ±20	2.5	150	1.9±0.20	
MCASQ32NSB7104□TNA01	QMK325 B7104□NHT	250	X7R	0.1 μ	±10, ±20	2.5	150	1.9±0.20	
MCASQ32NSB7154□TNA01	QMK325 B7154□NHT	250	X7R	0.15 μ	±10, ±20	2.5	150	1.9±0.20	
MCASQ32NSB7224□TNA01	QMK325 B7224□NHT	250	X7R	0.22 μ	±10, ±20	2.5	150	1.9±0.20	
MCASS32NSB7223□TNA01	SMK325 B7223□NHT	630	X7R	0.022 μ	±10, ±20	2.5	120	1.9±0.20	
MCASS32NSB7333□TNA01	SMK325 B7333□NHT	630	X7R	0.033 μ	±10, ±20	2.5	120	1.9±0.20	
MCASS32NSB7473□TNA01	SMK325 B7473□NHT	630	X7R	0.047 μ	±10, ±20	2.5	120	1.9±0.20	

4532TYPE

【Temperature Characteristic B7 : X7R(-55~+125°C)】 2.5mm Thickness

New part number	Old part number (for reference)	Rated voltage [V]	Temperature characteristics	Capacitance [F]	Capacitance tolerance [%]	tan δ [%]	HTLT	Thickness*1 [mm]	Note
							Rated voltage x %		
MCASH45MSB7474□TNA01	HMK432 B7474□MHT	100	X7R	0.47 μ	±10, ±20	3.5	200	2.5±0.20	
MCASH45MSB7105□TNA01	HMK432 B7105□MHT	100	X7R	1 μ	±10, ±20	3.5	200	2.5±0.20	
MCASH45MSB7155□TNA01	HMK432 B7155□MHT	100	X7R	1.5 μ	±10, ±20	3.5	200	2.5±0.20	
MCASH45MSB7225□TNA01	HMK432 B7225□MHT	100	X7R	2.2 μ	±10, ±20	3.5	200	2.5±0.20	
MCASQ45MSB7104□TNA01	QMK432 B7104□MHT	250	X7R	0.1 μ	±10, ±20	2.5	150	2.5±0.20	
MCASQ45MSB7224□TNA01	QMK432 B7224□MHT	250	X7R	0.22 μ	±10, ±20	2.5	150	2.5±0.20	
MCASQ45MSB7334□TNA01	QMK432 B7334□MHT	250	X7R	0.33 μ	±10, ±20	2.5	150	2.5±0.20	
MCASQ45MSB7474□TNA01	QMK432 B7474□MHT	250	X7R	0.47 μ	±10, ±20	2.5	150	2.5±0.20	
MCASS45MSB7473□TNA01	SMK432 B7473□MHT	630	X7R	0.047 μ	±10, ±20	2.5	120	2.5±0.20	
MCASS45MSB7683□TNA01	SMK432 B7683□MHT	630	X7R	0.068 μ	±10, ±20	2.5	120	2.5±0.20	
MCASS45MSB7104□TNA01	SMK432 B7104□MHT	630	X7R	0.1 μ	±10, ±20	2.5	120	2.5±0.20	

PART NUMBER

High frequency/Low loss Medium-High Voltage Multilayer Ceramic Capacitors for Automotive Body & Chassis and Infotainment

1005TYPE

【Temperature Characteristic CG : CG/C0G(-55~+125°C)】 0.5mm Thickness

New part number	Old part number (for reference)	Rated voltage [V]	Temperature characteristics		Capacitance [F]	Capacitance tolerance	Q [at 1MHz] (Min)	HTLT	Thickness*1 [mm]	Note
								Rated voltage x %		
MCARQ105SCG0R5□FRA01	QVS105 CG0R5□VHF	250	CG	C0G	0.5 p	±0.1pF, ±0.25pF	810	200	0.5±0.05	
MCARQ105SCG0R6□FRA01	QVS105 CG0R6□VHF	250	CG	C0G	0.6 p	±0.1pF, ±0.25pF	812	200	0.5±0.05	
MCARQ105SCG0R7□FRA01	QVS105 CG0R7□VHF	250	CG	C0G	0.7 p	±0.1pF, ±0.25pF	814	200	0.5±0.05	
MCARQ105SCG0R75□FRA01	QVS105 CG0R75□VHF	250	CG	C0G	0.75 p	±0.1pF, ±0.25pF	815	200	0.5±0.05	
MCARQ105SCG0R8□FRA01	QVS105 CG0R8□VHF	250	CG	C0G	0.8 p	±0.1pF, ±0.25pF	816	200	0.5±0.05	
MCARQ105SCG0R9□FRA01	QVS105 CG0R9□VHF	250	CG	C0G	0.9 p	±0.1pF, ±0.25pF	818	200	0.5±0.05	
MCARQ105SCG010□FRA01	QVS105 CG010□VHF	250	CG	C0G	1 p	±0.1pF, ±0.25pF	820	200	0.5±0.05	
MCARQ105SCG1R1□FRA01	QVS105 CG1R1□VHF	250	CG	C0G	1.1 p	±0.1pF, ±0.25pF	822	200	0.5±0.05	
MCARQ105SCG1R2□FRA01	QVS105 CG1R2□VHF	250	CG	C0G	1.2 p	±0.1pF, ±0.25pF	824	200	0.5±0.05	
MCARQ105SCG1R3□FRA01	QVS105 CG1R3□VHF	250	CG	C0G	1.3 p	±0.1pF, ±0.25pF	826	200	0.5±0.05	
MCARQ105SCG1R5□FRA01	QVS105 CG1R5□VHF	250	CG	C0G	1.5 p	±0.1pF, ±0.25pF	830	200	0.5±0.05	
MCARQ105SCG1R6□FRA01	QVS105 CG1R6□VHF	250	CG	C0G	1.6 p	±0.1pF, ±0.25pF	832	200	0.5±0.05	
MCARQ105SCG1R8□FRA01	QVS105 CG1R8□VHF	250	CG	C0G	1.8 p	±0.1pF, ±0.25pF	836	200	0.5±0.05	
MCARQ105SCG020□FRA01	QVS105 CG020□VHF	250	CG	C0G	2 p	±0.1pF, ±0.25pF	840	200	0.5±0.05	
MCARQ105SCG2R2□FRA01	QVS105 CG2R2□VHF	250	CG	C0G	2.2 p	±0.1pF, ±0.25pF	844	200	0.5±0.05	
MCARQ105SCG2R4□FRA01	QVS105 CG2R4□VHF	250	CG	C0G	2.4 p	±0.1pF, ±0.25pF	848	200	0.5±0.05	
MCARQ105SCG2R7□FRA01	QVS105 CG2R7□VHF	250	CG	C0G	2.7 p	±0.1pF, ±0.25pF	854	200	0.5±0.05	
MCARQ105SCG030□FRA01	QVS105 CG030□VHF	250	CG	C0G	3 p	±0.1pF, ±0.25pF	860	200	0.5±0.05	
MCARQ105SCG3R3□FRA01	QVS105 CG3R3□VHF	250	CG	C0G	3.3 p	±0.1pF, ±0.25pF	866	200	0.5±0.05	
MCARQ105SCG3R6□FRA01	QVS105 CG3R6□VHF	250	CG	C0G	3.6 p	±0.1pF, ±0.25pF	872	200	0.5±0.05	
MCARQ105SCG3R9□FRA01	QVS105 CG3R9□VHF	250	CG	C0G	3.9 p	±0.1pF, ±0.25pF	878	200	0.5±0.05	
MCARQ105SCG4R3□FRA01	QVS105 CG4R3□VHF	250	CG	C0G	4.3 p	±0.1pF, ±0.25pF	886	200	0.5±0.05	
MCARQ105SCG4R7□FRA01	QVS105 CG4R7□VHF	250	CG	C0G	4.7 p	±0.1pF, ±0.25pF	894	200	0.5±0.05	
MCARQ105SCG5R1□FRA01	QVS105 CG5R1□VHF	250	CG	C0G	5.1 p	±0.25pF, ±0.5pF	902	200	0.5±0.05	
MCARQ105SCG5R6□FRA01	QVS105 CG5R6□VHF	250	CG	C0G	5.6 p	±0.25pF, ±0.5pF	912	200	0.5±0.05	
MCARQ105SCG6R2□FRA01	QVS105 CG6R2□VHF	250	CG	C0G	6.2 p	±0.25pF, ±0.5pF	924	200	0.5±0.05	
MCARQ105SCG6R8□FRA01	QVS105 CG6R8□VHF	250	CG	C0G	6.8 p	±0.25pF, ±0.5pF	936	200	0.5±0.05	
MCARQ105SCG7R5□FRA01	QVS105 CG7R5□VHF	250	CG	C0G	7.5 p	±0.25pF, ±0.5pF	950	200	0.5±0.05	
MCARQ105SCG8R2□FRA01	QVS105 CG8R2□VHF	250	CG	C0G	8.2 p	±0.25pF, ±0.5pF	964	200	0.5±0.05	
MCARQ105SCG9R1□FRA01	QVS105 CG9R1□VHF	250	CG	C0G	9.1 p	±0.25pF, ±0.5pF	982	200	0.5±0.05	
MCARQ105SCG100JVFA01	QVS105 CG100JVHF	250	CG	C0G	10 p	±5%	1000	200	0.5±0.05	
MCARQ105SCG110JVFA01	QVS105 CG110JVHF	250	CG	C0G	11 p	±5%	1020	200	0.5±0.05	
MCARQ105SCG120JVFA01	QVS105 CG120JVHF	250	CG	C0G	12 p	±5%	1040	200	0.5±0.05	
MCARQ105SCG130JVFA01	QVS105 CG130JVHF	250	CG	C0G	13 p	±5%	1060	200	0.5±0.05	
MCARQ105SCG150JVFA01	QVS105 CG150JVHF	250	CG	C0G	15 p	±5%	1100	200	0.5±0.05	
MCARQ105SCG160JVFA01	QVS105 CG160JVHF	250	CG	C0G	16 p	±5%	1120	200	0.5±0.05	
MCARQ105SCG180JVFA01	QVS105 CG180JVHF	250	CG	C0G	18 p	±5%	1160	200	0.5±0.05	
MCARQ105SCG200JVFA01	QVS105 CG200JVHF	250	CG	C0G	20 p	±5%	1200	200	0.5±0.05	
MCARQ105SCG220JVFA01	QVS105 CG220JVHF	250	CG	C0G	22 p	±5%	1240	200	0.5±0.05	
MCARQ105SCG240JVFA01	QVS105 CG240JVHF	250	CG	C0G	24 p	±5%	1280	200	0.5±0.05	
MCARQ105SCG270JVFA01	QVS105 CG270JVHF	250	CG	C0G	27 p	±5%	1340	200	0.5±0.05	
MCARQ105SCG300JVFA01	QVS105 CG300JVHF	250	CG	C0G	30 p	±5%	1400	200	0.5±0.05	
MCARQ105SCG330JVFA01	QVS105 CG330JVHF	250	CG	C0G	33 p	±5%	1400	200	0.5±0.05	

PART NUMBER

1608TYPE

【Temperature Characteristic CG : CG/C0G(−55~+125°C)】 0.7mm Thickness

New part number	Old part number (for reference)	Rated voltage [V]	Temperature characteristics		Capacitance [F]	Capacitance tolerance	Q [at 1MHz] (Min)	HTLT	Thickness*1 [mm]	Note
								Rated voltage x %		
MCARQ167SCG0R2□TRA01	QVS107 CG0R2□CHT	250	CG	C0G	0.2 p	±0.05pF, ±0.1pF	804	200	0.7±0.10	
MCARQ167SCG0R3□TRA01	QVS107 CG0R3□CHT	250	CG	C0G	0.3 p	±0.05pF, ±0.1pF	806	200	0.7±0.10	
MCARQ167SCG0R4□TRA01	QVS107 CG0R4□CHT	250	CG	C0G	0.4 p	±0.05pF, ±0.1pF	808	200	0.7±0.10	
MCARQ167SCG0R5□TRA01	QVS107 CG0R5□CHT	250	CG	C0G	0.5 p	±0.1pF, ±0.25pF	810	200	0.7±0.10	
MCARQ167SCG0R6□TRA01	QVS107 CG0R6□CHT	250	CG	C0G	0.6 p	±0.1pF, ±0.25pF	812	200	0.7±0.10	
MCARQ167SCG0R7□TRA01	QVS107 CG0R7□CHT	250	CG	C0G	0.7 p	±0.1pF, ±0.25pF	814	200	0.7±0.10	
MCARQ167SCG0R75□TRA01	QVS107 CG0R75□CHT	250	CG	C0G	0.75 p	±0.1pF, ±0.25pF	815	200	0.7±0.10	
MCARQ167SCG0R8□TRA01	QVS107 CG0R8□CHT	250	CG	C0G	0.8 p	±0.1pF, ±0.25pF	816	200	0.7±0.10	
MCARQ167SCG0R9□TRA01	QVS107 CG0R9□CHT	250	CG	C0G	0.9 p	±0.1pF, ±0.25pF	818	200	0.7±0.10	
MCARQ167SCG010□TRA01	QVS107 CG010□CHT	250	CG	C0G	1 p	±0.1pF, ±0.25pF	820	200	0.7±0.10	
MCARQ167SCG1R1□TRA01	QVS107 CG1R1□CHT	250	CG	C0G	1.1 p	±0.1pF, ±0.25pF	822	200	0.7±0.10	
MCARQ167SCG1R2□TRA01	QVS107 CG1R2□CHT	250	CG	C0G	1.2 p	±0.1pF, ±0.25pF	824	200	0.7±0.10	
MCARQ167SCG1R3□TRA01	QVS107 CG1R3□CHT	250	CG	C0G	1.3 p	±0.1pF, ±0.25pF	826	200	0.7±0.10	
MCARQ167SCG1R5□TRA01	QVS107 CG1R5□CHT	250	CG	C0G	1.5 p	±0.1pF, ±0.25pF	830	200	0.7±0.10	
MCARQ167SCG1R6□TRA01	QVS107 CG1R6□CHT	250	CG	C0G	1.6 p	±0.1pF, ±0.25pF	832	200	0.7±0.10	
MCARQ167SCG1R8□TRA01	QVS107 CG1R8□CHT	250	CG	C0G	1.8 p	±0.1pF, ±0.25pF	836	200	0.7±0.10	
MCARQ167SCG020□TRA01	QVS107 CG020□CHT	250	CG	C0G	2 p	±0.1pF, ±0.25pF	840	200	0.7±0.10	
MCARQ167SCG2R2□TRA01	QVS107 CG2R2□CHT	250	CG	C0G	2.2 p	±0.1pF, ±0.25pF	844	200	0.7±0.10	
MCARQ167SCG2R4□TRA01	QVS107 CG2R4□CHT	250	CG	C0G	2.4 p	±0.1pF, ±0.25pF	848	200	0.7±0.10	
MCARQ167SCG2R7□TRA01	QVS107 CG2R7□CHT	250	CG	C0G	2.7 p	±0.1pF, ±0.25pF	854	200	0.7±0.10	
MCARQ167SCG030□TRA01	QVS107 CG030□CHT	250	CG	C0G	3 p	±0.1pF, ±0.25pF	860	200	0.7±0.10	
MCARQ167SCG3R3□TRA01	QVS107 CG3R3□CHT	250	CG	C0G	3.3 p	±0.1pF, ±0.25pF	866	200	0.7±0.10	
MCARQ167SCG3R6□TRA01	QVS107 CG3R6□CHT	250	CG	C0G	3.6 p	±0.1pF, ±0.25pF	872	200	0.7±0.10	
MCARQ167SCG3R9□TRA01	QVS107 CG3R9□CHT	250	CG	C0G	3.9 p	±0.1pF, ±0.25pF	878	200	0.7±0.10	
MCARQ167SCG4R3□TRA01	QVS107 CG4R3□CHT	250	CG	C0G	4.3 p	±0.1pF, ±0.25pF	886	200	0.7±0.10	
MCARQ167SCG4R7□TRA01	QVS107 CG4R7□CHT	250	CG	C0G	4.7 p	±0.1pF, ±0.25pF	894	200	0.7±0.10	
MCARQ167SCG5R1□TRA01	QVS107 CG5R1□CHT	250	CG	C0G	5.1 p	±0.25pF, ±0.5pF	902	200	0.7±0.10	
MCARQ167SCG5R6□TRA01	QVS107 CG5R6□CHT	250	CG	C0G	5.6 p	±0.25pF, ±0.5pF	912	200	0.7±0.10	
MCARQ167SCG6R2□TRA01	QVS107 CG6R2□CHT	250	CG	C0G	6.2 p	±0.25pF, ±0.5pF	924	200	0.7±0.10	
MCARQ167SCG6R8□TRA01	QVS107 CG6R8□CHT	250	CG	C0G	6.8 p	±0.25pF, ±0.5pF	936	200	0.7±0.10	
MCARQ167SCG7R5□TRA01	QVS107 CG7R5□CHT	250	CG	C0G	7.5 p	±0.25pF, ±0.5pF	950	200	0.7±0.10	
MCARQ167SCG8R2□TRA01	QVS107 CG8R2□CHT	250	CG	C0G	8.2 p	±0.25pF, ±0.5pF	964	200	0.7±0.10	
MCARQ167SCG9R1□TRA01	QVS107 CG9R1□CHT	250	CG	C0G	9.1 p	±0.25pF, ±0.5pF	982	200	0.7±0.10	
MCARQ167SCG100□TRA01	QVS107 CG100□CHT	250	CG	C0G	10 p	±2%, ±5%	1000	200	0.7±0.10	
MCARQ167SCG110JTRA01	QVS107 CG110JCHT	250	CG	C0G	11 p	±5%	1020	200	0.7±0.10	
MCARQ167SCG120JTRA01	QVS107 CG120JCHT	250	CG	C0G	12 p	±5%	1040	200	0.7±0.10	
MCARQ167SCG130JTRA01	QVS107 CG130JCHT	250	CG	C0G	13 p	±5%	1060	200	0.7±0.10	
MCARQ167SCG150JTRA01	QVS107 CG150JCHT	250	CG	C0G	15 p	±5%	1100	200	0.7±0.10	
MCARQ167SCG160JTRA01	QVS107 CG160JCHT	250	CG	C0G	16 p	±5%	1120	200	0.7±0.10	
MCARQ167SCG180JTRA01	QVS107 CG180JCHT	250	CG	C0G	18 p	±5%	1160	200	0.7±0.10	
MCARQ167SCG200JTRA01	QVS107 CG200JCHT	250	CG	C0G	20 p	±5%	1200	200	0.7±0.10	
MCARQ167SCG220JTRA01	QVS107 CG220JCHT	250	CG	C0G	22 p	±5%	1240	200	0.7±0.10	
MCARQ167SCG240JTRA01	QVS107 CG240JCHT	250	CG	C0G	24 p	±5%	1280	200	0.7±0.10	
MCARQ167SCG270JTRA01	QVS107 CG270JCHT	250	CG	C0G	27 p	±5%	1340	200	0.7±0.10	
MCARQ167SCG300JTRA01	QVS107 CG300JCHT	250	CG	C0G	30 p	±5%	1400	200	0.7±0.10	
MCARQ167SCG330JTRA01	QVS107 CG330JCHT	250	CG	C0G	33 p	±5%	1400	200	0.7±0.10	
MCARQ167SCG360JTRA01	QVS107 CG360JCHT	250	CG	C0G	36 p	±5%	1400	200	0.7±0.10	
MCARQ167SCG390JTRA01	QVS107 CG390JCHT	250	CG	C0G	39 p	±5%	1400	200	0.7±0.10	
MCARQ167SCG430JTRA01	QVS107 CG430JCHT	250	CG	C0G	43 p	±5%	1400	200	0.7±0.10	
MCARQ167SCG470JTRA01	QVS107 CG470JCHT	250	CG	C0G	47 p	±5%	1400	200	0.7±0.10	
MCARQ167SCG510JTRA01	QVS107 CG510JCHT	250	CG	C0G	51 p	±5%	1400	200	0.7±0.10	
MCARQ167SCG560JTRA01	QVS107 CG560JCHT	250	CG	C0G	56 p	±5%	1400	200	0.7±0.10	
MCARQ167SCG620JTRA01	QVS107 CG620JCHT	250	CG	C0G	62 p	±5%	1400	200	0.7±0.10	
MCARQ167SCG680JTRA01	QVS107 CG680JCHT	250	CG	C0G	68 p	±5%	1400	200	0.7±0.10	
MCARQ167SCG750JTRA01	QVS107 CG750JCHT	250	CG	C0G	75 p	±5%	1400	200	0.7±0.10	
MCARQ167SCG820JTRA01	QVS107 CG820JCHT	250	CG	C0G	82 p	±5%	1400	200	0.7±0.10	
MCARQ167SCG910JTRA01	QVS107 CG910JCHT	250	CG	C0G	91 p	±5%	1400	200	0.7±0.10	
MCARQ167SCG101JTRA01	QVS107 CG101JCHT	250	CG	C0G	100 p	±5%	1400	200	0.7±0.10	

PART NUMBER

2012TYPE

【Temperature Characteristic CG : CG/C0G(−55~+125°C)】 0.85mm Thickness

New part number	Old part number (for reference)	Rated voltage [V]	Temperature characteristics		Capacitance [F]	Capacitance tolerance	Q [at 1MHz] (Min)	HTLT	Thickness*1 [mm]	Note
								Rated voltage x %		
MCARQ219SCG0R3□TRA01	QVS212 CG0R3□DHT	250	CG	C0G	0.3 p	±0.05pF, ±0.1pF, ±0.25pF	806	200	0.85±0.10	
MCARQ219SCG0R4□TRA01	QVS212 CG0R4□DHT	250	CG	C0G	0.4 p	±0.05pF, ±0.1pF, ±0.25pF	808	200	0.85±0.10	
MCARQ219SCG0R5□TRA01	QVS212 CG0R5□DHT	250	CG	C0G	0.5 p	±0.1pF, ±0.25pF	810	200	0.85±0.10	
MCARQ219SCG0R6□TRA01	QVS212 CG0R6□DHT	250	CG	C0G	0.6 p	±0.1pF, ±0.25pF	812	200	0.85±0.10	
MCARQ219SCG0R7□TRA01	QVS212 CG0R7□DHT	250	CG	C0G	0.7 p	±0.1pF, ±0.25pF	814	200	0.85±0.10	
MCARQ219SCG0R75□TRA01	QVS212 CGR75□DHT	250	CG	C0G	0.75 p	±0.1pF, ±0.25pF	815	200	0.85±0.10	
MCARQ219SCG0R8□TRA01	QVS212 CG0R8□DHT	250	CG	C0G	0.8 p	±0.1pF, ±0.25pF	816	200	0.85±0.10	
MCARQ219SCG0R9□TRA01	QVS212 CG0R9□DHT	250	CG	C0G	0.9 p	±0.1pF, ±0.25pF	818	200	0.85±0.10	
MCARQ219SCG010□TRA01	QVS212 CG010□DHT	250	CG	C0G	1 p	±0.1pF, ±0.25pF	820	200	0.85±0.10	
MCARQ219SCG1R1□TRA01	QVS212 CG1R1□DHT	250	CG	C0G	1.1 p	±0.1pF, ±0.25pF	822	200	0.85±0.10	
MCARQ219SCG1R2□TRA01	QVS212 CG1R2□DHT	250	CG	C0G	1.2 p	±0.1pF, ±0.25pF	824	200	0.85±0.10	
MCARQ219SCG1R3□TRA01	QVS212 CG1R3□DHT	250	CG	C0G	1.3 p	±0.1pF, ±0.25pF	826	200	0.85±0.10	
MCARQ219SCG1R5□TRA01	QVS212 CG1R5□DHT	250	CG	C0G	1.5 p	±0.1pF, ±0.25pF	830	200	0.85±0.10	
MCARQ219SCG1R6□TRA01	QVS212 CG1R6□DHT	250	CG	C0G	1.6 p	±0.1pF, ±0.25pF	832	200	0.85±0.10	
MCARQ219SCG1R8□TRA01	QVS212 CG1R8□DHT	250	CG	C0G	1.8 p	±0.1pF, ±0.25pF	836	200	0.85±0.10	
MCARQ219SCG020□TRA01	QVS212 CG020□DHT	250	CG	C0G	2 p	±0.1pF, ±0.25pF	840	200	0.85±0.10	
MCARQ219SCG2R2□TRA01	QVS212 CG2R2□DHT	250	CG	C0G	2.2 p	±0.1pF, ±0.25pF	844	200	0.85±0.10	
MCARQ219SCG2R4□TRA01	QVS212 CG2R4□DHT	250	CG	C0G	2.4 p	±0.1pF, ±0.25pF	848	200	0.85±0.10	
MCARQ219SCG2R7□TRA01	QVS212 CG2R7□DHT	250	CG	C0G	2.7 p	±0.1pF, ±0.25pF	854	200	0.85±0.10	
MCARQ219SCG030□TRA01	QVS212 CG030□DHT	250	CG	C0G	3 p	±0.1pF, ±0.25pF	860	200	0.85±0.10	
MCARQ219SCG3R3□TRA01	QVS212 CG3R3□DHT	250	CG	C0G	3 p	±0.1pF, ±0.25pF	866	200	0.85±0.10	
MCARQ219SCG3R6□TRA01	QVS212 CG3R6□DHT	250	CG	C0G	3.6 p	±0.1pF, ±0.25pF	872	200	0.85±0.10	
MCARQ219SCG3R9□TRA01	QVS212 CG3R9□DHT	250	CG	C0G	3.9 p	±0.1pF, ±0.25pF	878	200	0.85±0.10	
MCARQ219SCG4R3□TRA01	QVS212 CG4R3□DHT	250	CG	C0G	4.3 p	±0.1pF, ±0.25pF	886	200	0.85±0.10	
MCARQ219SCG4R7□TRA01	QVS212 CG4R7□DHT	250	CG	C0G	4.7 p	±0.1pF, ±0.25pF	894	200	0.85±0.10	
MCARQ219SCG5R1□TRA01	QVS212 CG5R1□DHT	250	CG	C0G	5.1 p	±0.25pF, ±0.5pF	902	200	0.85±0.10	
MCARQ219SCG5R6□TRA01	QVS212 CG5R6□DHT	250	CG	C0G	5.6 p	±0.25pF, ±0.5pF	912	200	0.85±0.10	
MCARQ219SCG6R2□TRA01	QVS212 CG6R2□DHT	250	CG	C0G	6.2 p	±0.25pF, ±0.5pF	924	200	0.85±0.10	
MCARQ219SCG6R8□TRA01	QVS212 CG6R8□DHT	250	CG	C0G	6.8 p	±0.25pF, ±0.5pF	936	200	0.85±0.10	
MCARQ219SCG7R5□TRA01	QVS212 CG7R5□DHT	250	CG	C0G	7.5 p	±0.25pF, ±0.5pF	950	200	0.85±0.10	
MCARQ219SCG8R2□TRA01	QVS212 CG8R2□DHT	250	CG	C0G	8.2 p	±0.25pF, ±0.5pF	964	200	0.85±0.10	
MCARQ219SCG9R1□TRA01	QVS212 CG9R1□DHT	250	CG	C0G	9.1 p	±0.25pF, ±0.5pF	982	200	0.85±0.10	
MCARQ219SCG100JTRA01	QVS212 CG100JDHT	250	CG	C0G	10 p	±5%	1000	200	0.85±0.10	
MCARQ219SCG110JTRA01	QVS212 CG110JDHT	250	CG	C0G	11 p	±5%	1020	200	0.85±0.10	
MCARQ219SCG120JTRA01	QVS212 CG120JDHT	250	CG	C0G	12 p	±5%	1040	200	0.85±0.10	
MCARQ219SCG130JTRA01	QVS212 CG130JDHT	250	CG	C0G	13 p	±5%	1060	200	0.85±0.10	
MCARQ219SCG150JTRA01	QVS212 CG150JDHT	250	CG	C0G	15 p	±5%	1100	200	0.85±0.10	
MCARQ219SCG160JTRA01	QVS212 CG160JDHT	250	CG	C0G	16 p	±5%	1120	200	0.85±0.10	
MCARQ219SCG180JTRA01	QVS212 CG180JDHT	250	CG	C0G	18 p	±5%	1160	200	0.85±0.10	
MCARQ219SCG200JTRA01	QVS212 CG200JDHT	250	CG	C0G	20 p	±5%	1200	200	0.85±0.10	
MCARQ219SCG220JTRA01	QVS212 CG220JDHT	250	CG	C0G	22 p	±5%	1240	200	0.85±0.10	
MCARQ219SCG240JTRA01	QVS212 CG240JDHT	250	CG	C0G	24 p	±5%	1280	200	0.85±0.10	
MCARQ219SCG270JTRA01	QVS212 CG270JDHT	250	CG	C0G	27 p	±5%	1340	200	0.85±0.10	
MCARQ219SCG300JTRA01	QVS212 CG300JDHT	250	CG	C0G	30 p	±5%	1400	200	0.85±0.10	
MCARQ219SCG330JTRA01	QVS212 CG330JDHT	250	CG	C0G	33 p	±5%	1400	200	0.85±0.10	
MCARQ219SCG360JTRA01	QVS212 CG360JDHT	250	CG	C0G	36 p	±5%	1400	200	0.85±0.10	
MCARQ219SCG390JTRA01	QVS212 CG390JDHT	250	CG	C0G	39 p	±5%	1400	200	0.85±0.10	
MCARQ219SCG430JTRA01	QVS212 CG430JDHT	250	CG	C0G	43 p	±5%	1400	200	0.85±0.10	
MCARQ219SCG470JTRA01	QVS212 CG470JDHT	250	CG	C0G	47 p	±5%	1400	200	0.85±0.10	
MCARQ219SCG510JTRA01	QVS212 CG510JDHT	250	CG	C0G	51 p	±5%	1400	200	0.85±0.10	
MCARQ219SCG560JTRA01	QVS212 CG560JDHT	250	CG	C0G	56 p	±5%	1400	200	0.85±0.10	
MCARQ219SCG620JTRA01	QVS212 CG620JDHT	250	CG	C0G	62 p	±5%	1400	200	0.85±0.10	
MCARQ219SCG680JTRA01	QVS212 CG680JDHT	250	CG	C0G	68 p	±5%	1400	200	0.85±0.10	
MCARQ219SCG750JTRA01	QVS212 CG750JDHT	250	CG	C0G	75 p	±5%	1400	200	0.85±0.10	
MCARQ219SCG820JTRA01	QVS212 CG820JDHT	250	CG	C0G	82 p	±5%	1400	200	0.85±0.10	
MCARQ219SCG910JTRA01	QVS212 CG910JDHT	250	CG	C0G	91 p	±5%	1400	200	0.85±0.10	
MCARQ219SCG101JTRA01	QVS212 CG101JDHT	250	CG	C0G	100 p	±5%	1400	200	0.85±0.10	

PART NUMBER

Soft Termination Multilayer Ceramic Capacitors for Automotive Body & Chassis and Infotainment

● 1608TYPE

【Temperature Characteristic B7 : X7R(-55~+125°C)】 0.8mm Thickness

New part number	Old part number (for reference)	Rated voltage [V]	Temperature characteristics	Capacitance [F]	Capacitance tolerance [%]	tan δ [%]	HTLT	Thickness*1 [mm]	Note
							Rated voltage x %		
MCJCT168BB7473TPA01	TMJ107BB7473AHT	25	X7R	0.047 μ	±10, ±20	3.5	200	0.8+0.20/-0	
MCJCT168BB7104TPA01	TMJ107BB7104AHT	25	X7R	0.1 μ	±10, ±20	3.5	200	0.8+0.20/-0	
MCJCT168BB7224TPA01	TMJ107BB7224AHT	25	X7R	0.22 μ	±10, ±20	10	150	0.8+0.20/-0	
MCJCT168BB7474TPA01	TMJ107BB7474AHT	25	X7R	0.47 μ	±10, ±20	10	150	0.8+0.20/-0	
MCJCT168CB7105RPA01	TMJ107CB7105AHR	25	X7R	1 μ	±10, ±20	10	150	0.8+0.25/-0	
MCJCG168BB7473TPA01	GMJ107BB7473AHT	35	X7R	0.047 μ	±10, ±20	3.5	200	0.8+0.20/-0	
MCJCG168BB7104TPA01	GMJ107BB7104AHT	35	X7R	0.1 μ	±10, ±20	3.5	200	0.8+0.20/-0	
MCJCG168BB7224TPA01	GMJ107BB7224AHT	35	X7R	0.22 μ	±10, ±20	10	150	0.8+0.20/-0	
MCJCG168BB7474TPA01	GMJ107BB7474AHT	35	X7R	0.47 μ	±10, ±20	10	150	0.8+0.20/-0	
MCJCG168CB7105RPA01	GMJ107CB7105AHR	35	X7R	1 μ	±10, ±20	10	150	0.8+0.25/-0	
MCJCU168AB7102TPA01	UMJ107AB7102AHT	50	X7R	1000 p	±10, ±20	3.5	200	0.8+0.15/-0.05	
MCJCU168AB7222TPA01	UMJ107AB7222AHT	50	X7R	2200 p	±10, ±20	3.5	200	0.8+0.15/-0.05	
MCJCU168BB7472TPA01	UMJ107BB7472AHT	50	X7R	4700 p	±10, ±20	3.5	200	0.8+0.20/-0	
MCJCU168BB7103TPA01	UMJ107BB7103AHT	50	X7R	0.01 μ	±10, ±20	3.5	200	0.8+0.20/-0	
MCJCU168BB7223TPA01	UMJ107BB7223AHT	50	X7R	0.022 μ	±10, ±20	3.5	200	0.8+0.20/-0	
MCJCU168BB7473TPA01	UMJ107BB7473AHT	50	X7R	0.047 μ	±10, ±20	3.5	200	0.8+0.20/-0	
MCJCU168BB7104TPA01	UMJ107BB7104AHT	50	X7R	0.1 μ	±10, ±20	3.5	200	0.8+0.20/-0	
MCJCH168AB7102TPA01	HMJ107AB7102AHT	100	X7R	1000 p	±10, ±20	3.5	200	0.8+0.15/-0.05	
MCJCH168AB7222TPA01	HMJ107AB7222AHT	100	X7R	2200 p	±10, ±20	3.5	200	0.8+0.15/-0.05	
MCJCH168BB7472TPA01	HMJ107BB7472AHT	100	X7R	4700 p	±10, ±20	3.5	200	0.8+0.20/-0	
MCJCH168BB7103TPA01	HMJ107BB7103AHT	100	X7R	0.01 μ	±10, ±20	3.5	200	0.8+0.20/-0	
MCJCH168BB7223TPA01	HMJ107BB7223AHT	100	X7R	0.022 μ	±10, ±20	3.5	200	0.8+0.20/-0	
MCJCH168BB7473TPA01	HMJ107BB7473AHT	100	X7R	0.047 μ	±10, ±20	3.5	200	0.8+0.20/-0	
MCJCH168BB7104TPA01	HMJ107BB7104AHT	100	X7R	0.1 μ	±10, ±20	3.5	200	0.8+0.20/-0	

● 2012TYPE

【Temperature Characteristic B7 : X7R(-55~+125°C), C7 : X7S(-55~+125°C)】 0.85mm Thickness、1.25mm Thickness

New part number	Old part number (for reference)	Rated voltage [V]	Temperature characteristics	Capacitance [F]	Capacitance tolerance [%]	tan δ [%]	HTLT	Thickness*1 [mm]	Note
							Rated voltage x %		
MCJCJ21GCB7106TPA01	UMJ212CB7106GHT	6.3	X7R	10 μ	±10, ±20	10	150	1.25+0.25/-0	
MCJCE21GCB7225TPA01	EMJ212CB7225GHT	16	X7R	2.2 μ	±10, ±20	10	150	1.25+0.25/-0	
MCJCE21GCB7475TPA01	EMJ212CB7475GHT	16	X7R	4.7 μ	±10, ±20	10	150	1.25+0.25/-0	
MCJCT21GCB7225TPA01	TMJ212CB7225GHT	25	X7R	2.2 μ	±10, ±20	10	150	1.25+0.25/-0	
MCJCG21GCB7105TPA01	GMJ212CB7105GHT	35	X7R	1 μ	±10, ±20	10	150	1.25+0.25/-0	
MCJCU21GCB7103TPA01	UMJ212BB7103GHT	50	X7R	0.01 μ	±10, ±20	3.5	200	1.25+0.20/-0	
MCJCU21GCB7223TPA01	UMJ212BB7223GHT	50	X7R	0.022 μ	±10, ±20	3.5	200	1.25+0.20/-0	
MCJCU21GCB7473TPA01	UMJ212BB7473GHT	50	X7R	0.047 μ	±10, ±20	3.5	200	1.25+0.20/-0	
MCJCU21GCB7104TPA01	UMJ212BB7104GHT	50	X7R	0.1 μ	±10, ±20	3.5	200	1.25+0.20/-0	
MCJCU21GCB7224TPA01	UMJ212BB7224GHT	50	X7R	0.22 μ	±10, ±20	3.5	200	1.25+0.20/-0	
MCJCU21GCC7474TDA01	UMJ212CC7474GHTE	50	X7S	0.47 μ	±10, ±20	3.5	150	1.25+0.25/-0	
MCJCU21GCB7105TPA01	UMJ212CB7105GHT	50	X7R	1 μ	±10, ±20	10	150	1.25+0.25/-0	
MCJCH219NB7102TPA01	HMJ212KB7102DHT	100	X7R	1000 p	±10, ±20	3.5	200	0.85±0.15	
MCJCH219NB7222TPA01	HMJ212KB7222DHT	100	X7R	2200 p	±10, ±20	3.5	200	0.85±0.15	
MCJCH21GCB7472TPA01	HMJ212BB7472GHT	100	X7R	4700 p	±10, ±20	3.5	200	1.25+0.20/-0	
MCJCH21GCB7103TPA01	HMJ212BB7103GHT	100	X7R	0.01 μ	±10, ±20	3.5	200	1.25+0.20/-0	
MCJCH21GCB7223TPA01	HMJ212BB7223GHT	100	X7R	0.022 μ	±10, ±20	3.5	200	1.25+0.20/-0	
MCJCH21GCB7473TPA01	HMJ212BB7473GHT	100	X7R	0.047 μ	±10, ±20	3.5	200	1.25+0.20/-0	
MCJCH21GCB7104TPA01	HMJ212BB7104GHT	100	X7R	0.1 μ	±10, ±20	3.5	200	1.25+0.20/-0	
MCJCH21GCB7224TPA01	HMJ212BB7224GHT	100	X7R	0.22 μ	±10, ±20	3.5	200	1.25+0.20/-0	
MCJCH21GCC7474TDA01	HMJ212CC7474GHTE	100	X7S	0.47 μ	±10, ±20	3.5	150	1.25+0.25/-0	
MCJCH21GDC7105TDA01	HMJ212DC7105GHTE	100	X7S	1 μ	±10, ±20	3.5	150	1.25+0.30/-0	
MCJQC219NB7102TPA01	QMJ212KB7102DHT	250	X7R	1000 p	±10, ±20	2.5	150	0.85±0.15	
MCJQC219NB7222TPA01	QMJ212KB7222DHT	250	X7R	2200 p	±10, ±20	2.5	150	0.85±0.15	
MCJQC21GCB7472TPA01	QMJ212BB7472GHT	250	X7R	4700 p	±10, ±20	2.5	150	1.25+0.20/-0	
MCJQC21GCB7103TPA01	QMJ212BB7103GHT	250	X7R	0.01 μ	±10, ±20	2.5	150	1.25+0.20/-0	
MCJQC21GCB7223TPA01	QMJ212BB7223GHT	250	X7R	0.022 μ	±10, ±20	2.5	150	1.25+0.20/-0	

PART NUMBER

LW Reversal Decoupling Low ESL Capacitors (LWDC™) for Automotive Body & Chassis and Infotainment

● 0510TYPE

【Temperature Characteristic B5(BJ) : X5R(-55~+85°C)】 0.3mm Thickness

New part number	Old part number (for reference)	Rated voltage [V]	Temperature characteristics		Capacitance [F]	Capacitance tolerance [%]	tan δ [%]	HTLT	Thickness*1 [mm]	Note
								Rated voltage x %		
MCRLT103SB5104MFNA01	TWK105 BJ104MPHF	25		X5R	0.1 μ	±20	5	150	0.3±0.05	
MCRLE103SB5224MFNA01	EWK105 BJ224MPHF	16		X5R	0.22 μ	±20	10	150	0.3±0.05	
MCRL103SB5474MFNA01	LWK105 BJ474MPHF	10		X5R	0.47 μ	±20	10	150	0.3±0.05	
MCRLA103SB5105MFNA01	AWK105 BJ105MPHF	4		X5R	1 μ	±20	10	150	0.3±0.05	

【Temperature Characteristic C6 : X6S(-55~+105°C), C7 : X7S(-55~+125°C)】 0.3mm Thickness

New part number	Old part number (for reference)	Rated voltage [V]	Temperature characteristics		Capacitance [F]	Capacitance tolerance [%]	tan δ [%]	HTLT	Thickness*1 [mm]	Note
								Rated voltage x %		
MCRLE103SC6104MFNA01	EWK105 C6104MPHF	16		X6S	0.1 μ	±20	5	150	0.3±0.05	
MCRLL103SC7104MFNA01	LWK105 C7104MPHF	10		X7S	0.1 μ	±20	5	150	0.3±0.05	
MCRL103SC6224MFNA01	LWK105 C6224MPHF	10		X6S	0.22 μ	±20	10	150	0.3±0.05	
MCRLJ103SC7104MFNA01	JWK105 C7104MPHF	6.3		X7S	0.1 μ	±20	5	150	0.3±0.05	
MCRLJ103SC7224MFNA01	JWK105 C7224MPHF	6.3		X7S	0.22 μ	±20	10	150	0.3±0.05	
MCRLJ103SC6474MFNA01	JWK105 C6474MPHF	6.3		X6S	0.47 μ	±20	10	150	0.3±0.05	
MCRLA103SC7224MFNA01	AWK105 C7224MPHF	4		X7S	0.22 μ	±20	10	150	0.3±0.05	
MCRLA103SC6474MFNA01	AWK105 C6474MPHF	4		X6S	0.47 μ	±20	10	150	0.3±0.05	

● 0816TYPE

【Temperature Characteristic B5(BJ) : X5R(-55~+85°C)】 0.5mm Thickness

New part number	Old part number (for reference)	Rated voltage [V]	Temperature characteristics		Capacitance [F]	Capacitance tolerance [%]	tan δ [%]	HTLT	Thickness*1 [mm]	Note
								Rated voltage x %		
MCRL165SB5105MTNA01	LWK107 BJ105MVHT	10		X5R	1 μ	±20	10	150	0.5±0.05	
MCRLJ165SB5225MTNA01	JWK107 BJ225MVHT	6.3		X5R	2.2 μ	±20	10	150	0.5±0.05	
MCRLJ165SB5475MTNA01	JWK107 BJ475MVHT	6.3		X5R	4.7 μ	±20	10	150	0.5±0.05	

【Temperature Characteristic B7 : X7R(-55~+125°C), C6 : X6S(-55~+105°C), C7 : X7S(-55~+125°C)】 0.5mm Thickness

New part number	Old part number (for reference)	Rated voltage [V]	Temperature characteristics		Capacitance [F]	Capacitance tolerance [%]	tan δ [%]	HTLT	Thickness*1 [mm]	Note
								Rated voltage x %		
MCRLT165SB7104MTNA01	TWK107 B7104MVHT	25		X7R	0.1 μ	±20	5	150	0.5±0.05	
MCRLE165SB7224MTNA01	EWK107 B7224MVHT	16		X7R	0.22 μ	±20	5	150	0.5±0.05	
MCRLE165SB7474MTNA01	EWK107 B7474MVHT	16		X7R	0.47 μ	±20	5	150	0.5±0.05	
MCRLL165SB7474MTNA01	LWK107 B7474MVHT	10		X7R	0.47 μ	±20	5	150	0.5±0.05	
MCRLJ165SC7105MTNA01	JWK107 C7105MVHT	6.3		X7S	1 μ	±20	10	150	0.5±0.05	
MCRLA165SC6225MTNA01	AWK107 C6225MVHT	4		X6S	2.2 μ	±20	10	150	0.5±0.05	
MCRLA165SC6475MTNA01	AWK107 C6475MVHT	4		X6S	4.7 μ	±20	10	150	0.5±0.05	

● 1220TYPE

【Temperature Characteristic B5(BJ) : X5R(-55~+85°C)】 0.85mm Thickness

New part number	Old part number (for reference)	Rated voltage [V]	Temperature characteristics		Capacitance [F]	Capacitance tolerance [%]	tan δ [%]	HTLT	Thickness*1 [mm]	Note
								Rated voltage x %		
MCRL219SB5475□TNA01	LWK212 BJ475□DHT	10		X5R	4.7 μ	±10, ±20	10	150	0.85±0.10	
MCRLJ219SB5106MTNA01	JWK212 BJ106MDHT	6.3		X5R	10 μ	±20	10	150	0.85±0.10	
MCRLA219SB5226MTNA01	AWK212 BJ226MDHT	4		X5R	22 μ	±20	10	150	0.85±0.10	

【Temperature Characteristic C6 : X6S(-55~+105°C)】 0.85mm Thickness

New part number	Old part number (for reference)	Rated voltage [V]	Temperature characteristics		Capacitance [F]	Capacitance tolerance [%]	tan δ [%]	HTLT	Thickness*1 [mm]	Note
								Rated voltage x %		
MCRLJ219SC6475□TNA01	JWK212 C6475□DHT	6.3		X6S	4.7 μ	±10, ±20	10	150	0.85±0.10	

Multilayer Ceramic Capacitors

PACKAGING

① Minimum Quantity

● Taped package

Type			Thickness		Standard Quantity [pcs]	
Code	JIS(mm)	EIA(inch)	[mm]	Code	Paper tape	Embossed tape
02	0201	008004	0.125	1	—	50000
04	0402	01005	0.2	2	—	40000
06	0603	0201	0.3	3	15000	—
1L	1005	0402	0.13	H	—	20000
			0.18	E	—	15000
			0.2	2	20000	—
			0.3	3	15000	—
10	1005	0402	0.5	5	10000	—
	0510 ※	0204	0.3	3	10000	—
16	1608	0603	0.45	K	4000	—
			0.7	7		
			0.8	8		
			0.8	8	3000 (Soft Termination)	3000 (Soft Termination)
	0816 ※	0306	0.5	5	—	4000
21	2012	0805	0.85	9	4000	—
			1.25	G	—	3000
			1.25	G	—	2000 (Soft Termination)
	1220 ※	0508	0.85	9	4000	—
31	3216	1206	0.85	9	4000	—
			1.15	Q	—	3000
			1.6	L	—	2000
32	3225	1210	0.85	9	—	2000
			1.15	Q		
			1.9	N		
			2.0 max	Y		
			2.5	M	—	500(T), 1000(P)
45	4532	1812	2.0 max	Y	—	1000
			2.5	M	—	500

注: ※LW Reverse type (MSRL, MCRL, MBRL, MLRL, MMRL)

② Taping material

※ No bottom tape for pressed carrier tape

- Card board carrier tape
- Embossed tape

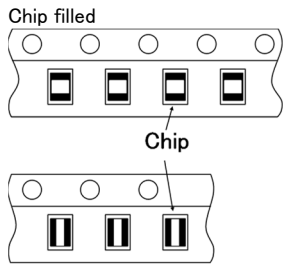
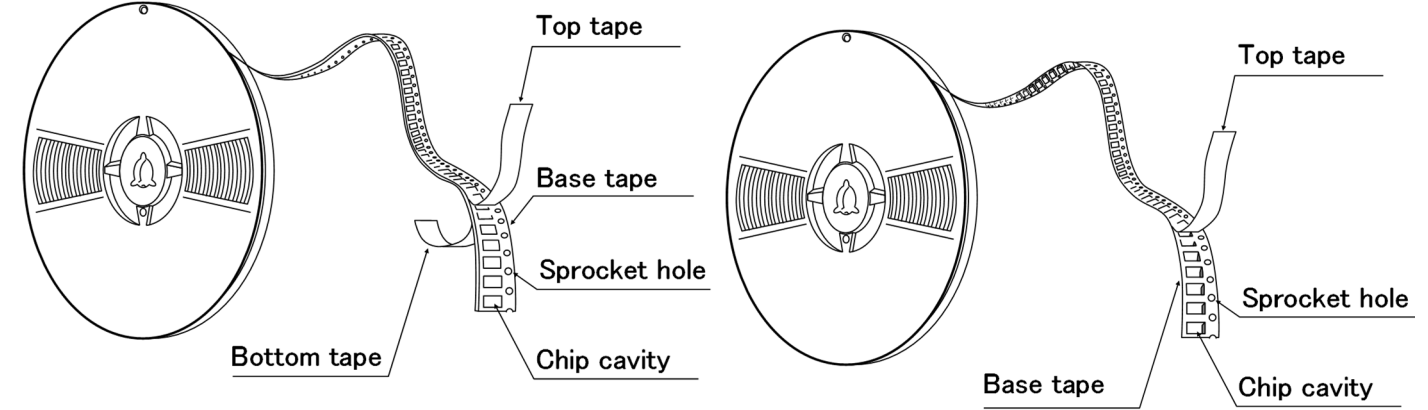

※ LW Reverse type.

③ Representative taping dimensions

● Paper Tape (8mm wide)

● Pressed carrier tape (2mm pitch)

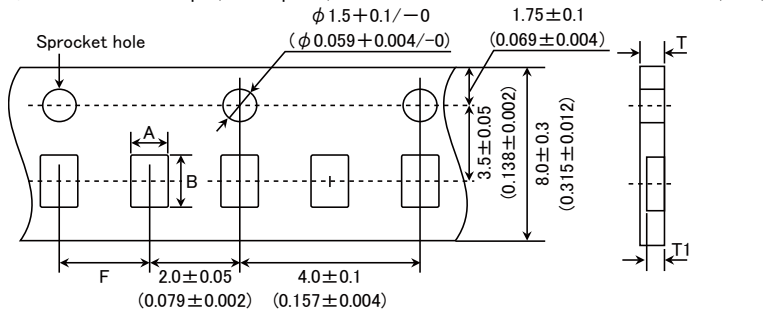

Type(EIA)	Chip Cavity		Insertion Pitch F	Tape Thickness	
	A	B		T	T1
0603 (0201)	0.37	0.67	2.0 ± 0.05	0.45max.	0.42max.
0510 (0204) ※	0.65	1.15		0.4max.	0.3max.
1005 (0402) (*1 2)				0.45max.	0.42max.
1005 (0402) (*1 3)					

Note *1 Thickness, 2:0.2mm, 3:0.3mm. ※ LW Reverse type.

Unit: mm

● Punched carrier tape (2mm pitch)

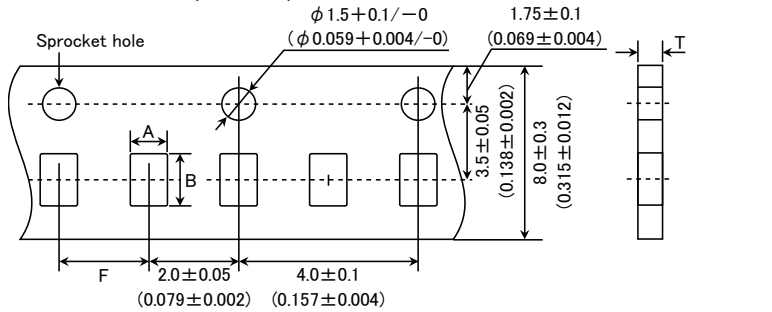

Type(EIA)	Chip Cavity		Insertion Pitch F	Tape Thickness
	A	B		T
1005 (0402)	0.65	1.15	2.0 ± 0.05	0.8max.

Unit: mm

▶ This catalog contains the typical specification only due to the limitation of space. When you consider the purchase of our products, please check our specification. For details of each product (characteristics graph, reliability information, precautions for use, and so on), see our Web site (<http://www.ty-top.com/>).

● Punched carrier tape (4mm pitch)

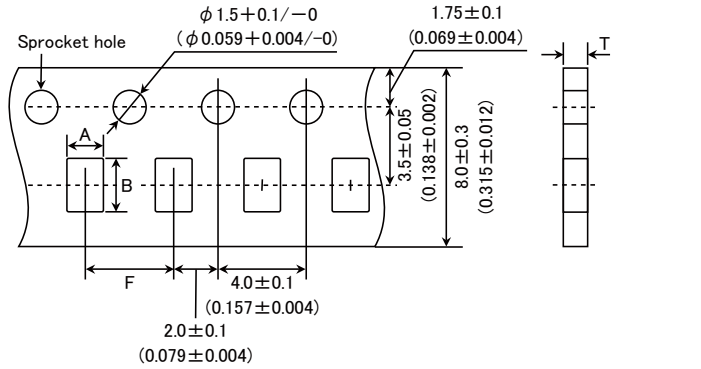

Type(EIA)	Chip Cavity		Insertion Pitch F	Tape Thickness	
	A	B		K	T
1608 (0603)	1.0	1.8	4.0 ± 0.1	1.1max.	1.1max.
0816 (0306) ※					
2012 (0805)					
1220 (0508) ※	1.65	2.4	4.0 ± 0.1	1.1max.	1.1max.
3216 (1206)	2.0	3.6			

Note: Taping size might be different depending on the size of the product. ※ LW Reverse type.

Unit: mm

● Embossed tape (4mm wide)

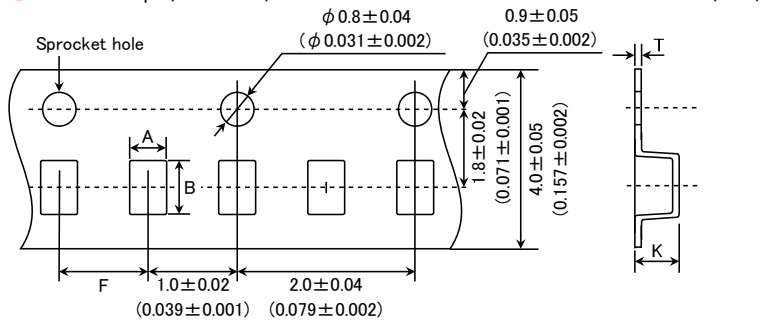

Type(EIA)	Chip Cavity		Insertion Pitch F	Tape Thickness	
	A	B		K	T
0201 (008004)	0.135	0.27	1.0 ± 0.02	0.5max.	0.25max.
0402 (01005)	0.23	0.43			

Unit: mm

● Embossed tape (8mm wide)

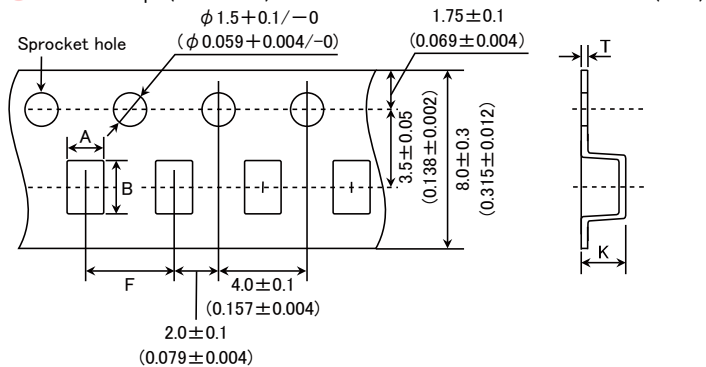

Type(EIA)	Chip Cavity		Insertion Pitch F	Tape Thickness	
	A	B		K	T
1005 (0402)	0.6	1.1	2.0 ± 0.1	0.6max	0.2 ± 0.1
0816 (0306) ※	1.0	1.8	4.0 ± 0.1	1.3max.	0.25 ± 0.1
2012 (0805)	1.65	2.4			
3216 (1206)	2.0	3.6			
3225 (1210)	2.8	3.6		3.4max.	0.6max.

Note: ※ LW Reverse type.

Unit: mm

► This catalog contains the typical specification only due to the limitation of space. When you consider the purchase of our products, please check our specification. For details of each product (characteristics graph, reliability information, precautions for use, and so on), see our Web site (<http://www.ty-top.com/>).

● Embossed tape (12mm wide) Unit: mm (inch)

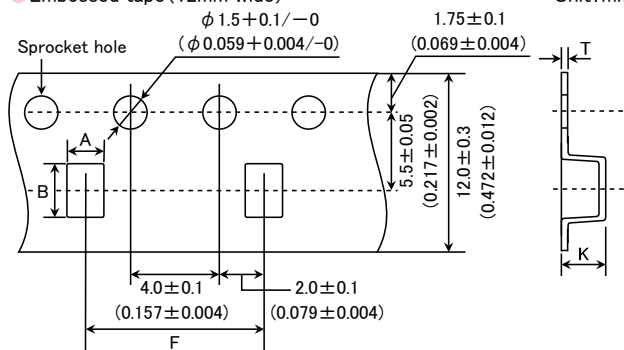

Type(EIA)	Chip Cavity		Insertion Pitch	Tape Thickness	
	A	B		K	T
3225 (1210)	3.1	4.0	8.0 ± 0.1	4.0max.	0.6max.
4532 (1812)	3.7	4.9	8.0 ± 0.1	4.0max.	0.6max.

Unit: mm

④ Trailer and Leader

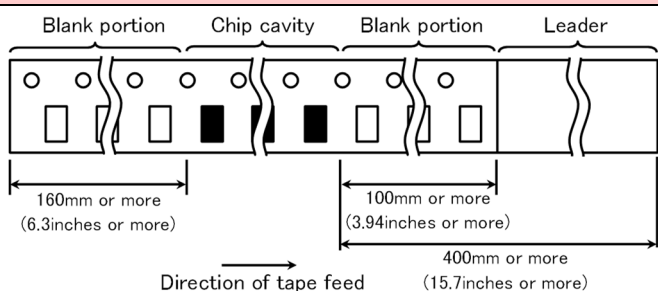

⑤ Reel size

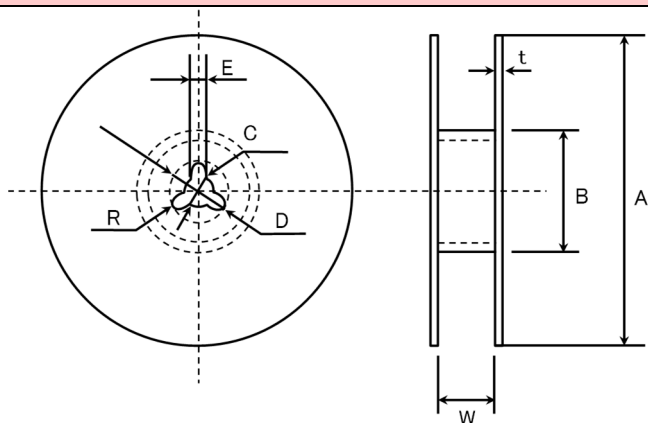

A	B	C	D	E	R
$\phi 178 \pm 2.0$	$\phi 50 \text{min.}$	$\phi 13.0 \pm 0.2$	$\phi 21.0 \pm 0.8$	2.0 ± 0.5	1.0

	T	W
4mm wide tape	1.5max.	5 ± 1.0
8mm wide tape	2.5max.	10 ± 1.5
12mm wide tape	2.5max.	14 ± 1.5

Unit: mm

⑥ Top Tape Strength

The top tape requires a peel-off force of 0.1 to 0.7N in the direction of the arrow as illustrated below.

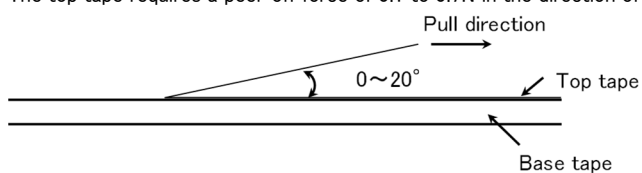

▶ This catalog contains the typical specification only due to the limitation of space. When you consider the purchase of our products, please check our specification. For details of each product (characteristics graph, reliability information, precautions for use, and so on), see our Web site (<http://www.ty-top.com/>).

Multilayer Ceramic Capacitors for Automotive Body & Chassis and Infotainment

RELIABILITY DATA

1. Operating Temperature Range

Specified Value	Temperature Compensating (Class1)	-55 to +125°C		
	High Permittivity (Class2)		Specification	Temperature Range
		B5	X5R	-55 to +85°C
		B7	X7R	-55 to +125°C
		C6	X6S	-55 to +105°C
		C7	X7S	-55 to +125°C
D7	X7T	-55 to +125°C		

2. Storage Conditions

Specified Value	Temperature Compensating (Class1)	-55 to +125°C		
	High Permittivity (Class2)		Specification	Temperature Range
		B5	X5R	-55 to +85°C
		B7	X7R	-55 to +125°C
		C6	X6S	-55 to +105°C
		C7	X7S	-55 to +125°C
D7	X7T	-55 to +125°C		

3. Rated Voltage

Specified Value	Temperature Compensating (Class1)	Standard	50VDC, 25VDC
		High Frequency Type	250VDC
	High Permittivity (Class2)		630VDC, 250VDC, 100VDC 50VDC, 35VDC, 25VDC, 16VDC, 10VDC, 6.3VDC, 4VDC

4. Withstanding Voltage (Between terminals)

Specified Value	Temperature Compensating (Class1)	No breakdown or damage	
	High Permittivity (Class2)		
Test Methods and Remarks		Class 1	Class 2
	Applied voltage	Rated voltage × 3 Rated voltage (Code Q) × 2	Rated voltage × 2.5 Rated voltage (Code Q) × 2, Rated voltage (Code S) × 1.2
	Duration	1 to 5 sec.	
	Charge/discharge current	50mA max.	

5. Insulation Resistance

Specified Value	Temperature Compensating (Class1)	10000 MΩ min.
	High Permittivity (Class2) Note 1	C ≤ 0.047 μF : 10000 MΩ min. C > 0.047 μF : 500 MΩ · μF (C: Nominal capacitance)
Test Methods and Remarks	Applied voltage	: Rated voltage, 500V (Code S)
	Duration	: 60 ± 5 sec.
	Charge/discharge current	: 50mA max.

► This catalog contains the typical specification only due to the limitation of space. When you consider the purchase of our products, please check our specification. For details of each product (characteristics graph, reliability information, precautions for use, and so on), see our Web site (<http://www.ty-top.com/>).

6. Capacitance (Tolerance)

Specified Value	Temperature Compensating (Class1)	Standard	$C \leq 5\text{pF} : \pm 0.25\text{pF}$ $5\text{pF} < C \leq 10\text{pF} : \pm 0.5\text{pF}$ $C > 10\text{pF} : \pm 5\%$ (C:Nominal capacitance)		
		High Frequency Type	Refer to detailed specification		
	High Permittivity (Class2)		$\pm 10\%$ or $\pm 20\%$		
Test Methods and Remarks		Class 1		Class 2	
		Standard	High Frequency Type	$C \leq 10 \mu\text{F}$	$C > 10 \mu\text{F}$
	Preconditioning	None		Thermal treatment (at 150°C for 1hr) No.9	
	Measuring frequency	$1\text{MHz} \pm 10\%$		$1\text{kHz} \pm 10\%$	$120 \pm 10\text{Hz}$
	Measuring voltage Note 1	0.5 to 5Vrms		$1 \pm 0.2\text{Vrms}$	$0.5 \pm 0.1\text{rms}$
	Bias application	None			

7. Q or Dissipation Factor

Specified Value	Temperature Compensating (Class1)	Standard	$C < 30\text{pF} : Q \geq 400 + 20C$ $C \geq 30\text{pF} : Q \geq 1000$ (C:Nominal capacitance)		
		High Frequency Type	Refer to detailed specification		
	High Permittivity (Class2) Note 1		2.5% max.		
Test Methods and Remarks		Class 1		Class 2	
		Standard	High Frequency Type	$C \leq 10 \mu\text{F}$	$C > 10 \mu\text{F}$
	Preconditioning	None		Thermal treatment (at 150°C for 1hr) No.9	
	Measuring frequency	$1\text{MHz} \pm 10\%$		$1\text{kHz} \pm 10\%$	$120 \pm 10\text{Hz}$
	Measuring voltage Note 1	0.5 to 5Vrms		$1 \pm 0.2\text{Vrms}$	$0.5 \pm 0.1\text{Vrms}$
	Bias application	None			

8. Pre- and Post-Stress Electrical test

Measurement at $25 \pm 5^\circ\text{C}$

9. Heat treatment

Value shall be measured after test sample is heat treated at $150 +0/-10^\circ\text{C}$ for an hour and kept at room temperature for 24 ± 2 hrs.
 ※ Heat treatment is applicable to High dielectric type.

10. High Temperature Exposure (Storage)

Specified Value	Temperature Compensating (Class1)	Standard	Appearance : No abnormality Cap. Change : Within $\pm 3\%$ or $\pm 0.3\text{pF}$, whichever is larger. Q : $C < 10\text{pF} : Q \geq 200 + 10C$ $10 \leq C < 30\text{pF} : Q \geq 275 + 2.5C$ $C \geq 30\text{pF} : Q \geq 350$ (C:Nominal capacitance) IR : $1000\text{M}\Omega$ min	
		High Frequency Type	Appearance : No abnormality Cap. Change : Within $\pm 3\%$ or $\pm 0.3\text{pF}$, whichever is larger. IR : $1000\text{M}\Omega$ min	
	High Permittivity (Class2) Note 1		Appearance : No abnormality Cap. Change : Within $\pm 12.5\%$ $\tan \delta$: 5% max IR : Within $50\text{M}\Omega/\mu\text{F}$ or $100\text{M}\Omega$, whichever is smaller.	
Test Methods and Remarks	Heat treatment specified in this specification shall be conducted prior to test. No.9 Temperature: The maximum operating temperature shall be used. Duration: Unpowered 1000 hrs. Measurement shall be performed after test sample following the test is heated at $150+0/-10^\circ\text{C}$ for an hour and kept at room temperature for 24 ± 2 hrs. No.9			

11. Temperature Cycling			
Specified Value	Temperature Compensating (Class1)	Standard	Appearance : No abnormality Cap. Change : Within $\pm 2.5\%$ or $\pm 0.25\text{pF}$, whichever is larger. Q : Initial value IR : Initial value
		High Frequency Type	Appearance : No abnormality Cap. Change : Within $\pm 2.5\%$ or $\pm 0.25\text{pF}$, whichever is larger. IR : Initial value
	High Permittivity (Class2)		Appearance : No abnormality Cap. Change : Within $\pm 7.5\%$ $\tan \delta$: Initial value IR : Initial value
Test Methods and Remarks	Heat treatment specified in this specification shall be conducted prior to test. No.9 Temperature: Minimum operating temperature to Maximum operating temperature Number of cycles: 1000 cycles Maximum dwell time at each temperature extreme: 30 min Maximum transition time: Within 1 min Measurement shall be performed after test sample following the test is heated at $150+0/-10^\circ\text{C}$ for an hour and kept at room temperature for 24 ± 2 hours. No.9		

12. Destructive Physical Analysis	
Specified Value	No abnormality
Test Methods and Remarks	Per EIA-469

13. Biased Humidity			
Specified Value	Temperature Compensating (Class1)	Standard	Appearance : No abnormality Cap. Change : Within $\pm 7.5\%$ or $\pm 0.75\text{pF}$, whichever is larger. Q : $C < 30\text{pF} : Q \geq 100 + 10C/3$ $C \geq 30\text{pF} : Q \geq 200$ (C: Nominal capacitance) IR : $500M\Omega \text{ min}$
		High Frequency Type	Appearance : No abnormality Cap. Change : $C \leq 2.0\text{pF} : \pm 0.4\text{pF}$ $2.0\text{pF} < C < 10\text{pF} : \pm 0.75\text{pF}$ $C \geq 10\text{pF} : \pm 7.5\%$ (C: Nominal capacitance) IR : $500M\Omega \text{ min}$
	High Permittivity (Class2) Note 1		Appearance : No abnormality Cap. Change : Within $\pm 12.5\%$ $\tan \delta$: 5% max IR : Within $25M\Omega \mu\text{F}$ or $500M\Omega$ whichever is smaller.
Test Methods and Remarks	Heat treatment specified in this specification shall be conducted prior to test. No.9 Temperature: 85°C Humidity: 85%RH Duration: 1000hrs Applied voltage: Rated voltage and 1.3 to 1.5V. Measurement shall be performed after test sample following the test is heated at $150+0/-10^\circ\text{C}$ for an hour and kept at room temperature for 24 ± 2 hours. No.9		

14. Temperature Cycle (Thermal Shock)			
Specified Value	Temperature Compensating (Class1)	Standard	Appearance : No abnormality Cap. Change : Within $\pm 3.0\%$ or $\pm 0.3\text{pF}$, whichever is larger. Q : $C < 10\text{pF} : Q \geq 200 + 10C$ $10 \leq C < 30\text{pF} : Q \geq 275 + 2.5C$ $C \geq 30\text{pF} : Q \geq 350$ (C: Nominal capacitance) IR : $1000\text{M}\Omega \text{ min}$
		High Frequency Type	Appearance : No abnormality Cap. Change : Within $\pm 3.0\%$ or $\pm 0.3\text{pF}$, whichever is larger. IR : $1000\text{M}\Omega \text{ min}$
	High Permittivity (Class2) Note 1		Appearance : No abnormality Cap. Change : Within $\pm 12.5\%$ $\tan \delta$: 5% max IR : Within $50\text{M}\Omega/\mu\text{F}$ or $1000\text{M}\Omega$ whichever is smaller.
Test Methods and Remarks	Heat treatment specified in this specification shall be conducted prior to test. No.9 Temperature: Maximum operating temperature Duration: 1000hrs Applied voltage: Rated voltage Measurement shall be performed after test sample following the test is heated at $150 \pm 0 / -10^\circ\text{C}$ for an hour and kept at room temperature for 24 ± 2 hours. No.9		

15. External Visual	
Specified Value	No abnormality
Test Methods and Remarks	Visual inspection shall be performed.

16. Physical Dimension	
Specified Value	Refer to detailed specification
Test Methods and Remarks	Verify physical dimensions to the applicable device specification.

17. Resistance to Solvents	
Specified Value	Appearance : No abnormality Cap. Change : Initial value Q or $\tan \delta$: Initial value IR : Initial value
Test Methods and Remarks	Heat treatment specified in this specification shall be conducted prior to test. No.9 Add Aqueous wash chemical OKEMCLEAN (A 6% concentrated Oakite cleaner) or equivalent.

18. Mechanical Shock	
Specified Value	Appearance : No abnormality Cap. Change : Initial value Q or $\tan \delta$: Initial value IR : Initial value
Test Methods and Remarks	Heat treatment specified in this specification shall be conducted prior to test. No.9 Three shocks in each direction should be applied along 3 mutually perpendicular axes of the test specimen (18 shocks). Peak value: 1500g Duration: 0.5ms Test pulse: Half-sine Velocity change: 4.7m/s.

19. Vibration	
Specified Value	Appearance : No abnormality Cap. Change : Initial value Q or $\tan \delta$: Initial value IR : Initial value
Test Methods and Remarks	Heat treatment specified in this specification shall be conducted prior to test. No.9 5g's for 20 min., 12 cycles each of 3 orientations. (Total: 36 cycles) Frequency range: 10Hz~2000Hz

20. Resistance to Soldering Heat

Specified Value	Temperature Compensating (Class1)	Standard	Appearance : No abnormality Cap. Change : Within $\pm 2.5\%$ or $\pm 0.25\text{pF}$, whichever is larger. Q : Initial value IR : Initial value
		High Frequency Type	Appearance : No abnormality Cap. Change : Within $\pm 2.5\%$ or $\pm 0.25\text{pF}$, whichever is larger. IR : Initial value
	High Permittivity (Class2) Note 1		Appearance : No abnormality Cap. Change : Within $\pm 7.5\%$ $\tan \delta$: Initial value IR : Initial value
Test Methods and Remarks	Heat treatment specified in this specification shall be conducted prior to test. No.9 Dipping Solder: $260 \pm 5^\circ\text{C}$ Time: 10 ± 1 sec. Measurement shall be performed after test sample following the test kept at room temperature for 24 ± 2 hours.		

21. ESC

Specified Value	Appearance: No abnormality IR: Initial value
Test Methods and Remarks	Heat treatment specified in this specification shall be conducted prior to test. No.9 Per AEC-Q200-002

22. Solderability

Specified Value	More than 95% of terminal electrode shall be covered with fresh solder.
Test Methods and Remarks	(a) Pb Free Solder Solder at $235 \pm 5^\circ\text{C}$ for 5sec. (b) SnPb Solder Solder at $215 \pm 5^\circ\text{C}$ for 5sec. (c) Wave Soldering (Pb Free Solder) Solder at $260 \pm 5^\circ\text{C}$ for 7sec.

23. Temperature Characteristic

Specified Value	Temperature Compensating (Class1)	Temp. chara. [ppm/ $^\circ\text{C}$]		Tolerance [ppm/ $^\circ\text{C}$]		
		$C \square : 0$	CG, CH, CJ, CK	G: ± 30 H: ± 60 J: ± 120 K: ± 250		
	High Permittivity (Class2)			Capacitance change rate	Reference temperature	Temperature range
		B5	X5R	$\pm 15\%$	25°C	$-55 \sim +85^\circ\text{C}$
		B7	X7R	$\pm 15\%$	25°C	$-55 \sim +125^\circ\text{C}$
		C6	X6S	$\pm 22\%$	25°C	$-55 \sim +105^\circ\text{C}$
		C7	X7S	$\pm 22\%$	25°C	$-55 \sim +125^\circ\text{C}$
		D7	X7T	$+22 / -33\%$	25°C	$-55 \sim +125^\circ\text{C}$
Test Methods and Remarks	Heat treatment specified in this specification shall be conducted prior to test. No.9 Capacitance shall be measured at room temperature as well as minimum and maximum operating temperatures.					

► This catalog contains the typical specification only due to the limitation of space. When you consider the purchase of our products, please check our specification. For details of each product (characteristics graph, reliability information, precautions for use, and so on), see our Web site (<http://www.ty-top.com/>).

24. Board Flex

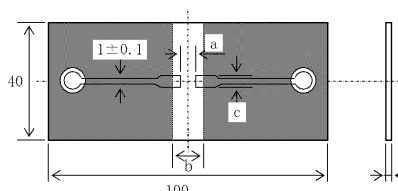
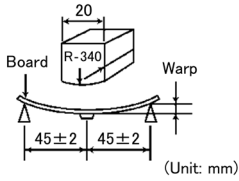
Specified Value	Appearance: No abnormality Cap. Change: $\pm 12.5\%$																																															
Test Methods and Remarks	<p>Heat treatment specified in this specification shall be conducted prior to test. No.9 Test sample is soldered onto the test board shown in Fig 1. The board is bent 2.0mm for 60 seconds as shown in Fig 2. Measurement shall be conducted as the board is bent 2.0mm.</p> <div style="display: flex; justify-content: space-around; align-items: flex-start;"> <div style="text-align: center;">  <p>Fig 1</p> </div> <table border="1" style="border-collapse: collapse; text-align: center;"> <thead> <tr> <th rowspan="2">Dimension</th> <th colspan="7">Case size [mm]</th> </tr> <tr> <th>0603</th> <th>1005</th> <th>1608</th> <th>2012</th> <th>3216</th> <th>3225</th> <th>4532</th> </tr> </thead> <tbody> <tr> <td>a</td> <td>0.3</td> <td>0.4</td> <td>1.0</td> <td>1.2</td> <td>2.2</td> <td>2.2</td> <td>3.5</td> </tr> <tr> <td>b</td> <td>0.9</td> <td>1.5</td> <td>3.0</td> <td>4.0</td> <td>5.0</td> <td>5.0</td> <td>7.0</td> </tr> <tr> <td>c</td> <td>0.3</td> <td>0.5</td> <td>1.2</td> <td>1.65</td> <td>2.0</td> <td>2.9</td> <td>3.7</td> </tr> <tr> <td>Thickness</td> <td colspan="7">0.8</td> </tr> </tbody> </table> </div> <div style="text-align: center; margin-top: 10px;">  <p>Fig 2</p> <p>(Unit: mm)</p> </div>	Dimension	Case size [mm]							0603	1005	1608	2012	3216	3225	4532	a	0.3	0.4	1.0	1.2	2.2	2.2	3.5	b	0.9	1.5	3.0	4.0	5.0	5.0	7.0	c	0.3	0.5	1.2	1.65	2.0	2.9	3.7	Thickness	0.8						
Dimension	Case size [mm]																																															
	0603	1005	1608	2012	3216	3225	4532																																									
a	0.3	0.4	1.0	1.2	2.2	2.2	3.5																																									
b	0.9	1.5	3.0	4.0	5.0	5.0	7.0																																									
c	0.3	0.5	1.2	1.65	2.0	2.9	3.7																																									
Thickness	0.8																																															

25. Terminal Strength

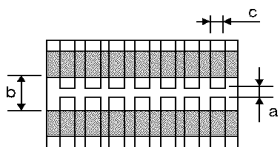
Specified Value	Appearance: No abnormality																																							
Test Methods and Remarks	<p>Per AEC-Q200-006 Test sample is soldered onto the test board shown in Fig 3. 0603 or greater (case size): 17.7N for 60\pm5 sec 0402 (case size): 5N for 30\pm5 sec. 0201 (case size): 2N for 30\pm5 sec.</p> <div style="display: flex; justify-content: space-around; align-items: flex-start;"> <div style="text-align: center;">  <p>Fig 3</p> </div> <table border="1" style="border-collapse: collapse; text-align: center;"> <thead> <tr> <th rowspan="2">Dimension</th> <th colspan="7">Case size [mm]</th> </tr> <tr> <th>0603</th> <th>1005</th> <th>1608</th> <th>2012</th> <th>3216</th> <th>3225</th> <th>4532</th> </tr> </thead> <tbody> <tr> <td>a</td> <td>0.3</td> <td>0.4</td> <td>1.0</td> <td>1.2</td> <td>2.2</td> <td>2.2</td> <td>3.5</td> </tr> <tr> <td>b</td> <td>0.9</td> <td>1.5</td> <td>3.0</td> <td>4.0</td> <td>5.0</td> <td>5.0</td> <td>7.0</td> </tr> <tr> <td>c</td> <td>0.3</td> <td>0.5</td> <td>1.2</td> <td>1.65</td> <td>2.0</td> <td>2.9</td> <td>3.7</td> </tr> </tbody> </table> </div>	Dimension	Case size [mm]							0603	1005	1608	2012	3216	3225	4532	a	0.3	0.4	1.0	1.2	2.2	2.2	3.5	b	0.9	1.5	3.0	4.0	5.0	5.0	7.0	c	0.3	0.5	1.2	1.65	2.0	2.9	3.7
Dimension	Case size [mm]																																							
	0603	1005	1608	2012	3216	3225	4532																																	
a	0.3	0.4	1.0	1.2	2.2	2.2	3.5																																	
b	0.9	1.5	3.0	4.0	5.0	5.0	7.0																																	
c	0.3	0.5	1.2	1.65	2.0	2.9	3.7																																	

26. Beam Load Test

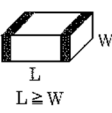
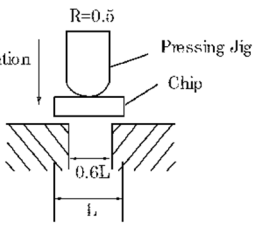
Specified Value	Destruction value should exceed 5N.
Test Methods and Remarks	<p>Per AEC-Q200-003</p> <div style="display: flex; align-items: center;"> <div style="margin-right: 20px;">  </div> <div>  </div> </div>

Note 1 The figures indicate typical specifications. Please refer to individual specifications in detail.

Multilayer Ceramic Capacitors

PRECAUTIONS

1. Circuit Design

- Precautions**
- ◆ Verification of operating environment, electrical rating and performance
 1. A malfunction of equipment in fields such as medical, aerospace, nuclear control, etc. may cause serious harm to human life or have severe social ramifications. Therefore, any capacitors to be used in such equipment may require higher safety and reliability, and shall be clearly differentiated from them used in general purpose applications.
 - ◆ Operating Voltage (Verification of Rated voltage)
 1. The operating voltage for capacitors must always be their rated voltage or less.
 - If an AC voltage is loaded on a DC voltage, the sum of the two peak voltages shall be the rated voltage or less.
 - For a circuit where an AC or a pulse voltage may be used, the sum of their peak voltages shall also be the rated voltage or less.
 2. Even if an applied voltage is the rated voltage or less reliability of capacitors may be deteriorated in case that either a high frequency AC voltage or a pulse voltage having rapid rise time is used in a circuit.

2. PCB Design

- Precautions**
- ◆ Pattern configurations (Design of Land-patterns)
 1. When capacitors are mounted on PCBs, the amount of solder used (size of fillet) can directly affect the capacitor performance. Therefore, the following items must be carefully considered in the design of land patterns:
 - (1) Excessive solder applied can cause mechanical stresses which lead to chip breaking or cracking. Therefore, please consider appropriate land-patterns for proper amount of solder.
 - (2) When more than one component are jointly soldered onto the same land, each component's soldering point shall be separated by solder-resist.
 - ◆ Pattern configurations (Capacitor layout on PCBs)

After capacitors are mounted on boards, they can be subjected to mechanical stresses in subsequent manufacturing processes (PCB cutting, board inspection, mounting of additional parts, assembly into the chassis, wave soldering of the boards, etc.). For this reason, land pattern configurations and positions of capacitors shall be carefully considered to minimize stresses.

Technical considerations

- ◆ Pattern configurations (Design of Land-patterns)

The following diagrams and tables show some examples of recommended land patterns to prevent excessive solder amounts.

(1) Recommended land dimensions for typical chip capacitors

 - Multilayer Ceramic Capacitors : Recommended land dimensions (unit: mm)

Wave-soldering

Type	1608	2012	3216	3225	
Size	L	1.6	2.0	3.2	3.2
	W	0.8	1.25	1.6	2.5
A	0.8 to 1.0	1.0 to 1.4	1.8 to 2.5	1.8 to 2.5	
B	0.5 to 0.8	0.8 to 1.5	0.8 to 1.7	0.8 to 1.7	
C	0.6 to 0.8	0.9 to 1.2	1.2 to 1.6	1.8 to 2.5	

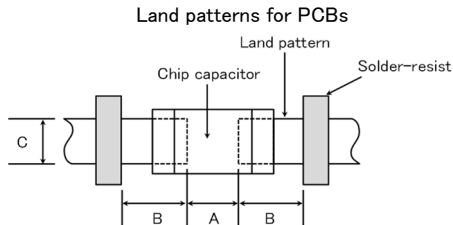

Reflow-soldering

Type	0201	0402	0603	1005	1608	2012	3216	3225	4532
Size	L	0.25	0.4	0.6	1.0	1.6	2.0	3.2	4.5
	W	0.125	0.2	0.3	0.5	0.8	1.25	1.6	2.5
A	0.095~0.135	0.15~0.25	0.20~0.30	0.45~0.55	0.6~0.8	0.8~1.2	1.8~2.5	1.8~2.5	2.5~3.5
B	0.085~0.125	0.10~0.20	0.20~0.30	0.40~0.50	0.6~0.8	0.8~1.2	1.0~1.5	1.0~1.5	1.5~1.8
C	0.110~0.150	0.15~0.30	0.25~0.40	0.45~0.55	0.6~0.8	0.9~1.6	1.2~2.0	1.8~3.2	2.3~3.5

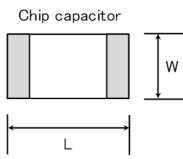

Note: Recommended land size might be different according to the allowance of the size of the product.

 - LWDC: Recommended land dimensions for reflow-soldering (unit: mm)

Type	0510	0816	1220	
Size	L	0.52	0.8	1.25
	W	1.0	1.6	2.0
A	0.18~0.22	0.25~0.3	0.5~0.7	
B	0.2~0.25	0.3~0.4	0.4~0.5	
C	0.9~1.1	1.5~1.7	1.9~2.1	

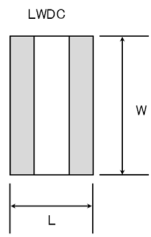

* This catalog contains the typical specification only due to the limitation of space. When you consider the purchase of our products, please check our specification. For details of each product (characteristics graph, reliability information, precautions for use, and so on), see our Web site (<http://www.ty-top.com/>).

(2) Examples of good and bad solder application

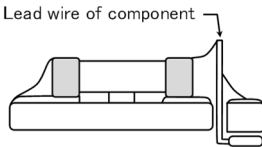
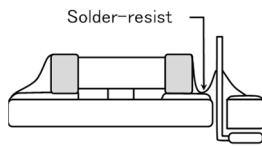
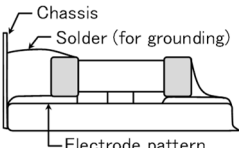
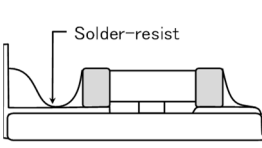
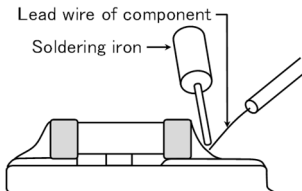
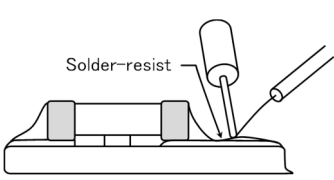
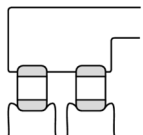
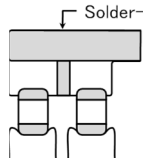
Item	Not recommended	Recommended
Mixed mounting of SMD and leaded components		
Component placement close to the chassis		
Hand-soldering of leaded components near mounted components		
Horizontal component placement		

◆ Pattern configurations (Capacitor layout on PCBs)

1-1. The following is examples of good and bad capacitor layouts ; capacitors shall be located to minimize any possible mechanical stresses from board warp or deflection.

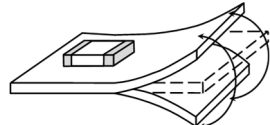
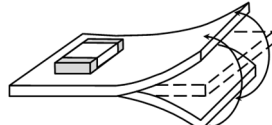
Items	Not recommended	Recommended
Deflection of board		 Place the product at a right angle to the direction of the anticipated mechanical stress.

1-2. The amount of mechanical stresses given will vary depending on capacitor layout. Please refer to diagram below.

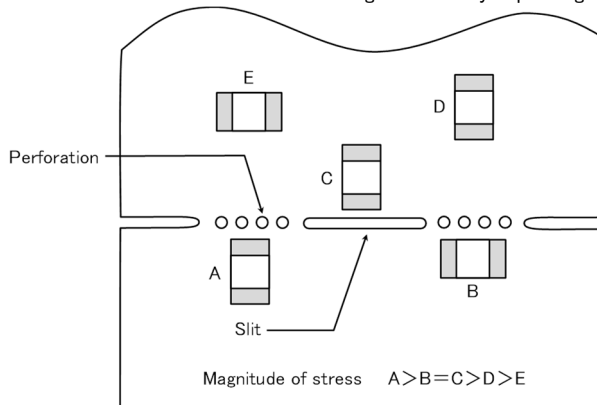

1-3. When PCB is split, the amount of mechanical stress on the capacitors can vary according to the method used. The following methods are listed in order from least stressful to most stressful: push-back, slit, V-grooving, and perforation. Thus, please consider the PCB, split methods as well as chip location.

3. Mounting

Precautions

◆ Adjustment of mounting machine

- When capacitors are mounted on PCB, excessive impact load shall not be imposed on them.
- Maintenance and inspection of mounting machines shall be conducted periodically.

◆ Selection of Adhesives

- When chips are attached on PCBs with adhesives prior to soldering, it may cause capacitor characteristics degradation unless the following factors are appropriately checked : size of land patterns, type of adhesive, amount applied, hardening temperature and hardening period. Therefore, please contact us for further information.

◆ Adjustment of mounting machine

1. When the bottom dead center of a pick-up nozzle is too low, excessive force is imposed on capacitors and causes damages. To avoid this, the following points shall be considerable.
 - (1) The bottom dead center of the pick-up nozzle shall be adjusted to the surface level of PCB without the board deflection.
 - (2) The pressure of nozzle shall be adjusted between 1 and 3 N static loads.
 - (3) To reduce the amount of deflection of the board caused by impact of the pick-up nozzle, supporting pins or back-up pins shall be used on the other side of the PCB. The following diagrams show some typical examples of good and bad pick-up nozzle placement:

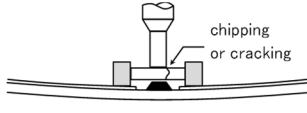
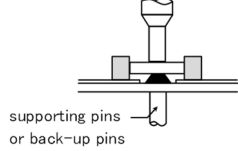
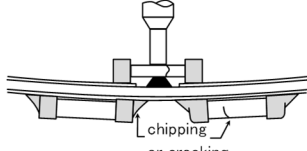
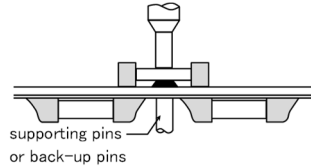
Item	Improper method	Proper method
Single-sided mounting		
Double-sided mounting		

Technical considerations

2. As the alignment pin is worn out, adjustment of the nozzle height can cause chipping or cracking of capacitors because of mechanical impact on the capacitors. To avoid this, the monitoring of the width between the alignment pins in the stopped position, maintenance, check and replacement of the pin shall be conducted periodically.

◆ Selection of Adhesives

Some adhesives may cause IR deterioration. The different shrinkage percentage of between the adhesive and the capacitors may result in stresses on the capacitors and lead to cracking. Moreover, too little or too much adhesive applied to the board may adversely affect components. Therefore, the following precautions shall be noted in the application of adhesives.

- (1) Required adhesive characteristics
 - a. The adhesive shall be strong enough to hold parts on the board during the mounting & solder process.
 - b. The adhesive shall have sufficient strength at high temperatures.
 - c. The adhesive shall have good coating and thickness consistency.
 - d. The adhesive shall be used during its prescribed shelf life.
 - e. The adhesive shall harden rapidly.
 - f. The adhesive shall have corrosion resistance.
 - g. The adhesive shall have excellent insulation characteristics.
 - h. The adhesive shall have no emission of toxic gasses and no effect on the human body.
- (2) The recommended amount of adhesives is as follows:

[Recommended condition]

Figure	2012/3216 case sizes as examples
a	0.3mm min
b	100 to 120 μm
c	Adhesives shall not contact land

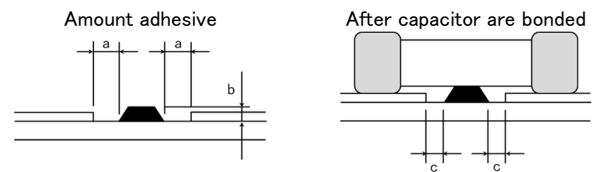

4. Soldering

◆ Selection of Flux

- Since flux may have a significant effect on the performance of capacitors, it is necessary to verify the following conditions prior to use;
- (1) Flux used shall be less than or equal to 0.1 wt% (in Cl equivalent) of halogenated content. Flux having a strong acidity content shall not be applied.
 - (2) When shall capacitors are soldered on boards, the amount of flux applied shall be controlled at the optimum level.
 - (3) When water-soluble flux is used, special care shall be taken to properly clean the boards.

Precautions

◆ Soldering

Temperature, time, amount of solder, etc. shall be set in accordance with their recommended conditions. Sn-Zn solder paste can adversely affect MLCC reliability. Please contact us prior to usage of Sn-Zn solder.

Technical considerations

◆ Selection of Flux

- 1-1. When too much halogenated substance (Chlorine, etc.) content is used to activate flux, or highly acidic flux is used, it may lead to corrosion of terminal electrodes or degradation of insulation resistance on the surfaces of the capacitors.
- 1-2. Flux is used to increase solderability in wave soldering. However if too much flux is applied, a large amount of flux gas may be emitted and may adversely affect the solderability. To minimize the amount of flux applied, it is recommended to use a flux-bubbling system.
- 1-3. Since the residue of water-soluble flux is easily dissolved in moisture in the air, the residues on the surfaces of capacitors in high humidity conditions may cause a degradation of insulation resistance and reliability of the capacitors. Therefore, the cleaning methods

▶ This catalog contains the typical specification only due to the limitation of space. When you consider the purchase of our products, please check our specification. For details of each product (characteristics graph, reliability information, precautions for use, and so on), see our Web site (<http://www.ty-top.com/>).

and the capability of the machines used shall also be considered carefully when water-soluble flux is used.

◆Soldering

- Ceramic chip capacitors are susceptible to thermal shock when exposed to rapid or concentrated heating or rapid cooling.
- Therefore, the soldering must be conducted with great care so as to prevent malfunction of the components due to excessive thermal shock.
- Preheating : Capacitors shall be preheated sufficiently, and the temperature difference between the capacitors and solder shall be within 130°C.
- Cooling : The temperature difference between the capacitors and cleaning process shall not be greater than 100°C.

[Reflow soldering]

【Recommended conditions for eutectic soldering】

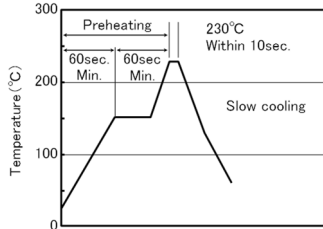

【Recommended condition for Pb-free soldering】

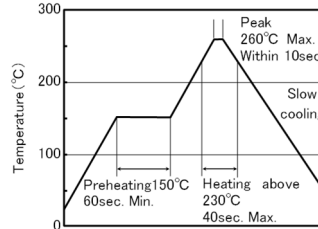

Caution

- ①The ideal condition is to have solder mass (fillet) controlled to 1/2 to 1/3 of the thickness of a capacitor.
- ②Because excessive dwell times can adversely affect solderability, soldering duration shall be kept as close to recommended times as possible. soldering for 2 times.

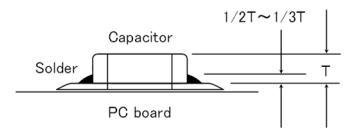

[Wave soldering]

【Recommended conditions for eutectic soldering】

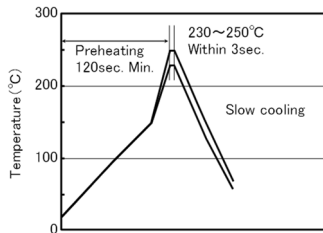

【Recommended condition for Pb-free soldering】

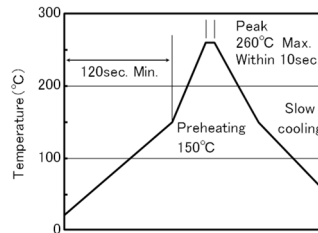

Caution

- ①Wave soldering must not be applied to capacitors designated as for reflow soldering only. soldering for 1 times.

[Hand soldering]

【Recommended conditions for eutectic soldering】

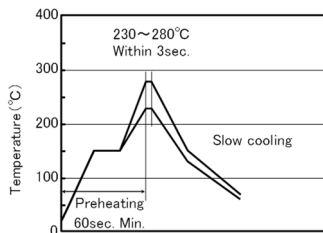

【Recommended condition for Pb-free soldering】

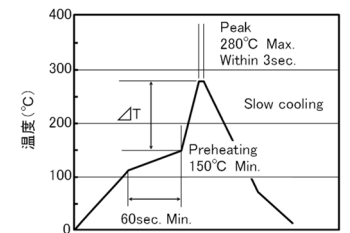
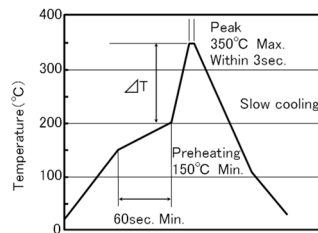

	ΔT
3216type or less	$\Delta T \leq 150^{\circ}\text{C}$

	ΔT
3225type or more	$\Delta T \leq 130^{\circ}\text{C}$

Caution

- ①Use a 50W soldering iron with a maximum tip diameter of 1.0 mm.
- ②The soldering iron shall not directly touch capacitors. soldering for 1 times.

5. Cleaning	
Precautions	<p>◆Cleaning conditions</p> <ol style="list-style-type: none"> When PCBs are cleaned after capacitors mounting, please select the appropriate cleaning solution in accordance with the intended use of the cleaning. (e.g. to remove soldering flux or other materials from the production process.) Cleaning condition shall be determined after it is verified by using actual cleaning machine that the cleaning process does not affect capacitor's characteristics.
Technical considerations	<ol style="list-style-type: none"> The use of inappropriate cleaning solutions can cause foreign substances such as flux residue to adhere to capacitors or deteriorate their outer coating, resulting in a degradation of the capacitor's electrical properties (especially insulation resistance). Inappropriate cleaning conditions (insufficient or excessive cleaning) may adversely affect the performance of the capacitors. In the case of ultrasonic cleaning, too much power output can cause excessive vibration of PCBs which may lead to the cracking of capacitors or the soldered portion, or decrease the terminal electrodes' strength. Therefore, the following conditions shall be carefully checked: Ultrasonic output : 20 W/l or less Ultrasonic frequency : 40 kHz or less Ultrasonic washing period : 5 min. or less

6. Resin coating and mold	
Precautions	<ol style="list-style-type: none"> With some type of resins, decomposition gas or chemical reaction vapor may remain inside the resin during the hardening period or while left under normal storage conditions resulting in the deterioration of the capacitor's performance. When a resin's hardening temperature is higher than capacitor's operating temperature, the stresses generated by the excessive heat may lead to damage or destruction of capacitors. The use of such resins, molding materials etc. is not recommended.

7. Handling	
Precautions	<p>◆Splitting of PCB</p> <ol style="list-style-type: none"> When PCBs are split after components mounting, care shall be taken so as not to give any stresses of deflection or twisting to the board. Board separation shall not be done manually, but by using the appropriate devices. <p>◆Mechanical considerations</p> <p>Be careful not to subject capacitors to excessive mechanical shocks.</p> <ol style="list-style-type: none"> If ceramic capacitors are dropped onto a floor or a hard surface, they shall not be used. Please be careful that the mounted components do not come in contact with or bump against other boards or components.

8. Storage conditions	
Precautions	<p>◆Storage</p> <ol style="list-style-type: none"> To maintain the solderability of terminal electrodes and to keep packaging materials in good condition, care must be taken to control temperature and humidity in the storage area. Humidity should especially be kept as low as possible. <ul style="list-style-type: none"> Recommended conditions Ambient temperature : Below 30°C Humidity : Below 70% RH The ambient temperature must be kept below 40°C. Even under ideal storage conditions, solderability of capacitor is deteriorated as time passes, so capacitors shall be used within 6 months from the time of delivery. <ul style="list-style-type: none"> Ceramic chip capacitors shall be kept where no chlorine or sulfur exists in the air. The capacitance values of high dielectric constant capacitors will gradually decrease with the passage of time, so care shall be taken to design circuits. Even if capacitance value decreases as time passes, it will get back to the initial value by a heat treatment at 150°C for 1hour.
Technical considerations	<p>If capacitors are stored in a high temperature and humidity environment, it might rapidly cause poor solderability due to terminal oxidation and quality loss of taping/packaging materials. For this reason, capacitors shall be used within 6 months from the time of delivery. If exceeding the above period, please check solderability before using the capacitors.</p>

※RCR-2335B (Safety Application Guide for fixed ceramic capacitors for use in electronic equipment) is published by JEITA.

Please check the guide regarding precautions for deflection test, soldering by spot heat, and so on.

X-ON Electronics

Largest Supplier of Electrical and Electronic Components

Click to view similar products for [Multilayer Ceramic Capacitors MLCC - SMD/SMT category:](#)

Click to view products by [Taiyo Yuden manufacturer:](#)

Other Similar products are found below :

[M39014/02-1218V](#) [M39014/02-1225V](#) [M39014/22-0631](#) [D55342E07B523DR-T/R](#) [NIN-FC2R7JTRF](#) [NMC0402NPO220J50TRPF](#)
[NMC0402X5R105K6.3TRPF](#) [NMC0402X5R224K6.3TRPF](#) [NMC0402X7R103J25TRPF](#) [NMC0402X7R392K50TRPF](#)
[NMC0603NPO101F50TRPF](#) [NMC0603NPO201J50TRPF](#) [NMC0603NPO330G50TRPF](#) [NMC0603NPO331F50TRPF](#)
[NMC0603X5R475M6.3TRPF](#) [NMC0603X7R333K16TRPF](#) [NMC0805NPO220J100TRPF](#) [NMC0805NPO820J50TRPF](#)
[NMC0805X7R224K25TRPF](#) [NMC1206X7R102K50TRPF](#) [NMC1206X7R106K10TRPLPF](#) [NMC-H0805X7R472K250TRPF](#)
[C1608C0G2A221J](#) [C1608X7R1E334K](#) [C2012C0G2A472J](#) [2220J2K00562KXT](#) [CCR06CG153FSV](#) [CDR04BX104AKSR](#)
[CDR33BX104AKUR](#) [CDR33BX683AKUS](#) [CGA3E1X7R1C684K](#) [CL10C0R8BB8ANNC](#) [M55342H06B20G0R-T/R](#) [C1005X5R0G225M](#)
[C2012X7R2E223K](#) [C3216C0G2J272J](#) [D55342E07B35E7R-T/R](#) [CDR34BX563BKUS](#) [CDR34BX563BKWS](#) [NMC0402NPO220F50TRPF](#)
[NMC0402X7R562J25TRPF](#) [NMC0603NPO102J25TRPF](#) [NMC1206X7R332K50TRPF](#) [NMC-P1206X7R104K250TRPLPF](#) [726632-1](#)
[CGA6M3X7R1H225K](#) [CGA5L2X7R2A105K](#) [CGA3E2X8R1H223K](#) [CDR33BX823AKUR\M500](#) [CDR33BP132BJUR](#)