

## Notice for TAIYO YUDEN products

Please read this notice before using the TAIYO YUDEN products.

### ⚠️ REMINDERS

#### ■ Product Information in this Catalog

Product information in this catalog is as of January 2021. All of the contents specified herein and production status of the products listed in this catalog are subject to change without notice due to technical improvement of our products, etc. Therefore, please check for the latest information carefully before practical application or use of our products.

Please note that TAIYO YUDEN shall not be in any way responsible for any damages and defects in products or equipment incorporating our products, which are caused under the conditions other than those specified in this catalog or individual product specification sheets.

#### ■ Approval of Product Specifications

Please contact TAIYO YUDEN for further details of product specifications as the individual product specification sheets are available. When using our products, please be sure to approve our product specifications or make a written agreement on the product specification with TAIYO YUDEN in advance.

#### ■ Pre-Evaluation in the Actual Equipment and Conditions

Please conduct validation and verification of our products in actual conditions of mounting and operating environment before using our products.

#### ■ Limited Application

##### 1. Equipment Intended for Use

The products listed in this catalog are intended for general-purpose and standard use in general electronic equipment (e.g., AV equipment, OA equipment, home electric appliances, office equipment, information and communication equipment including, without limitation, mobile phone, and PC) and other equipment specified in this catalog or the individual product specification sheets.

TAIYO YUDEN has the line-up of the products intended for use in automotive electronic equipment, telecommunications infrastructure and industrial equipment, or medical devices classified as GHTF Classes A to C (Japan Classes I to III). Therefore, when using our products for these equipment, please check available applications specified in this catalog or the individual product specification sheets and use the corresponding products.

##### 2. Equipment Requiring Inquiry

Please be sure to contact TAIYO YUDEN for further information before using the products listed in this catalog for the following equipment (excluding intended equipment as specified in this catalog or the individual product specification sheets) which may cause loss of human life, bodily injury, serious property damage and/or serious public impact due to a failure or defect of the products and/or malfunction attributed thereto.

- (1) Transportation equipment (automotive powertrain control system, train control system, and ship control system, etc.)
- (2) Traffic signal equipment
- (3) Disaster prevention equipment, crime prevention equipment
- (4) Medical devices classified as GHTF Class C (Japan Class III)
- (5) Highly public information network equipment, data-processing equipment (telephone exchange, and base station, etc.)
- (6) Any other equipment requiring high levels of quality and/or reliability equal to the equipment listed above

##### 3. Equipment Prohibited for Use

Please do not incorporate our products into the following equipment requiring extremely high levels of safety and/or reliability.

- (1) Aerospace equipment (artificial satellite, rocket, etc.)
- (2) Aviation equipment \*<sup>1</sup>
- (3) Medical devices classified as GHTF Class D (Japan Class IV), implantable medical devices \*<sup>2</sup>

- (4) Power generation control equipment (nuclear power, hydroelectric power, thermal power plant control system, etc.)
- (5) Undersea equipment (submarine repeating equipment, underwater work equipment, etc.)
- (6) Military equipment
- (7) Any other equipment requiring extremely high levels of safety and/or reliability equal to the equipment listed above

\*Notes:

1. There is a possibility that our products can be used only for aviation equipment that does not directly affect the safe operation of aircraft (e.g., in-flight entertainment, cabin light, electric seat, cooking equipment) if such use meets requirements specified separately by TAIYO YUDEN. Please be sure to contact TAIYO YUDEN for further information before using our products for such aviation equipment.
2. Implantable medical devices contain not only internal unit which is implanted in a body, but also external unit which is connected to the internal unit.

#### 4. Limitation of Liability

Please note that unless you obtain prior written consent of TAIYO YUDEN, TAIYO YUDEN shall not be in any way responsible for any damages incurred by you or third parties arising from use of the products listed in this catalog for any equipment that is not intended for use by TAIYO YUDEN, or any equipment requiring inquiry to TAIYO YUDEN or prohibited for use by TAIYO YUDEN as described above.

#### ■ Safety Design

When using our products for high safety and/or reliability-required equipment or circuits, please fully perform safety and/or reliability evaluation. In addition, please install (i) systems equipped with a protection circuit and a protection device and/or (ii) systems equipped with a redundant circuit or other system to prevent an unsafe status in the event of a single fault for a failsafe design to ensure safety.

#### ■ Intellectual Property Rights

Information contained in this catalog is intended to convey examples of typical performances and/or applications of our products and is not intended to make any warranty with respect to the intellectual property rights or any other related rights of TAIYO YUDEN or any third parties nor grant any license under such rights.

#### ■ Limited Warranty

Please note that the scope of warranty for our products is limited to the delivered our products themselves and TAIYO YUDEN shall not be in any way responsible for any damages resulting from a failure or defect in our products. Notwithstanding the foregoing, if there is a written agreement (e.g., supply and purchase agreement, quality assurance agreement) signed by TAIYO YUDEN and your company, TAIYO YUDEN will warrant our products in accordance with such agreement.

#### ■ TAIYO YUDEN's Official Sales Channel

The contents of this catalog are applicable to our products which are purchased from our sales offices or authorized distributors (hereinafter "TAIYO YUDEN's official sales channel"). Please note that the contents of this catalog are not applicable to our products purchased from any seller other than TAIYO YUDEN's official sales channel.

#### ■ Caution for Export

Some of our products listed in this catalog may require specific procedures for export according to "U.S. Export Administration Regulations", "Foreign Exchange and Foreign Trade Control Law" of Japan, and other applicable regulations. Should you have any questions on this matter, please contact our sales staff.

▶ This catalog contains the typical specification only due to the limitation of space. When you consider the purchase of our products, please check our product specification sheets. For details of each product (characteristics graph, reliability information, precautions for use, and so on), see our website (<http://www.ty-top.com/>).

# METAL MULTILAYER CHIP POWER INDUCTORS (MCOIL™ MC SERIES)

REFLOW

■ PARTS NUMBER

\* Operating Temp.: -40~+125°C(Including self-generated heat)

M	C	K	K	2	0	1	2	T	1	R	0	M	△	△	△	△
①	②	③	④	⑤	⑥	⑦										

△=Blank space

①Series name

Code	Series name
MC	Metal base multilayer chip power inductor

②Thickness

Code	Thickness [mm]
EK	0.50 max
EE	0.55 max
FK	0.60 max
FE	0.65 max
HK	0.80 max
KK	1.0 max

③Dimensions (L × W)

Code	Type (inch)	Dimensions (L × W) [mm]
1005	1005(0402)	1.0 × 0.5
1210	1210(0504)	1.25 × 1.05
1608	1608(0603)	1.6 × 0.8
2012	2012(0805)	2.0 × 1.25
2016	2016(0806)	2.0 × 1.6

④Packaging

Code	Packaging
T	Taping

⑤Nominal inductance

Code (example)	Nominal inductance [μH]
R24	0.24
R47	0.47
1R0	1.0

※R=Decimal point

⑥Inductance tolerance

Code	Inductance tolerance
M	±20%

⑦Special code

Code	Special code
△△△△	Standard
△N△△	Polarity Marking
HN△△	
KN△△	
G△△△	5 surface terminal
JG△B	

■ STANDARD EXTERNAL DIMENSIONS / STANDARD QUANTITY

Standard

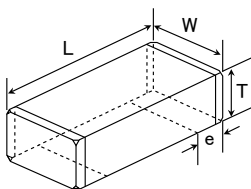

Polarity Marking

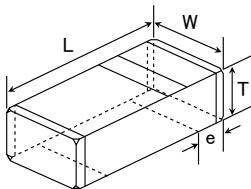

5 surface terminal

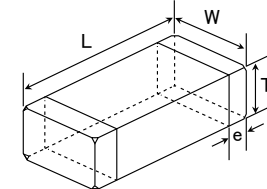

Type	L	W	T	e	Standard quantity [pcs]	
					Paper tape	Embossed tape
MCEE1005 (0402)	1.0±0.2 (0.039±0.008)	0.5±0.2 (0.020±0.008)	0.55 max (0.022 max)	0.25±0.15 (0.010±0.006)	10000	
MCEK1210 (0504)	1.25±0.1 (0.049±0.004)	1.05±0.1 (0.041±0.004)	0.50 max (0.020 max)	0.30±0.2 (0.012±0.008)	5000	—
MCFK1608 (0603)	1.6±0.2 (0.063±0.008)	0.8±0.2 (0.031±0.008)	0.60 max (0.024 max)	0.3±0.2 (0.012±0.008)	4000	—
MCFE1608 (0603)	1.6±0.2 (0.063±0.008)	0.8±0.2 (0.031±0.008)	0.65 max (0.026 max)	0.3±0.2 (0.012±0.008)	4000	—
MCHK1608 (0603)	1.6±0.2 (0.063±0.008)	0.8±0.2 (0.031±0.008)	0.80 max (0.031 max)	0.4±0.2 (0.016±0.008)	4000	—
MCKK1608 (0603)	1.6±0.2 (0.063±0.008)	0.8±0.2 (0.031±0.008)	1.0 max (0.039 max)	0.3±0.2 (0.012±0.008)	—	3000
MCHK2012 (0805)	2.0±0.2 (0.079±0.008)	1.25±0.2 (0.049±0.008)	0.80 max (0.031 max)	0.5±0.3 (0.02±0.012)	4000	—
MCKK2012 (0805)	2.0±0.2 (0.079±0.008)	1.25±0.2 (0.049±0.008)	1.0 max (0.039 max)	0.5±0.3 (0.02±0.012)	—	3000
MCFE2016 (0806)	2.0±0.2 (0.079±0.008)	1.6±0.2 (0.063±0.008)	0.65 max (0.026 max)	0.5±0.3 (0.02±0.012)	4000	—

Unit: mm (inch)

▶ This catalog contains the typical specification only due to the limitation of space. When you consider the purchase of our products, please check our product specification sheets. For details of each product (characteristics graph, reliability information, precautions for use, and so on), see our website (<http://www.ty-top.com/>).

## PARTS NUMBER

## ● MC1005

Parts number	EHS	Nominal inductance [ $\mu$ H]	Inductance tolerance	DC Resistance [m $\Omega$ ]		Rated current(I <sub>dc1</sub> ) [A] (max.)	Rated current(I <sub>dc2</sub> ) [A] (max.)	Measuring frequency [MHz]	Thickness [mm] (max.)
				(max.)	(typ.)				
MCEE1005TR10MHN	RoHS	0.10	$\pm 20\%$	50	41	2.00	2.00	1	0.55
MCEE1005TR22MHN	RoHS	0.22	$\pm 20\%$	80	65	1.60	1.60	1	0.55
MCEE1005TR47MHN	RoHS	0.47	$\pm 20\%$	140	114	1.20	1.20	1	0.55
MCEE1005TR10MHN	RoHS	1.0	$\pm 20\%$	300	244	1.00	0.80	1	0.55

## ● MC1210

Parts number	EHS	Nominal inductance [ $\mu$ H]	Inductance tolerance	DC Resistance [m $\Omega$ ]		Rated current(I <sub>dc1</sub> ) [A] (max.)	Rated current(I <sub>dc2</sub> ) [A] (max.)	Measuring frequency [MHz]	Thickness [mm] (max.)
				(max.)	(typ.)				
MCEK1210TR47MHN	RoHS	0.47	$\pm 20\%$	82	70	2.30	1.60	1	0.50
MCEK1210TR10MHN	RoHS	1.0	$\pm 20\%$	179	157	1.50	1.10	1	0.50
MCEK1210TR15MHN	RoHS	1.5	$\pm 20\%$	240	200	1.20	0.90	1	0.50

## ● MC1608

Parts number	EHS	Nominal inductance [ $\mu$ H]	Inductance tolerance	DC Resistance [m $\Omega$ ]		Rated current(I <sub>dc1</sub> ) [A] (max.)	Rated current(I <sub>dc2</sub> ) [A] (max.)	Measuring frequency [MHz]	Thickness [mm] (max.)
				(max.)	(typ.)				
MCFK1608TR24M	RoHS	0.24	$\pm 20\%$	50	40	2.30	2.10	1	0.60
MCFK1608TR47M	RoHS	0.47	$\pm 20\%$	85	69	1.90	1.60	1	0.60
MCFK1608TR10M	RoHS	1.0	$\pm 20\%$	224	182	1.50	0.90	1	0.60
MCFE1608TR24MG	RoHS	0.24	$\pm 20\%$	100	75	2.60	1.50	1	0.65
MCFE1608TR47MG	RoHS	0.47	$\pm 20\%$	150	114	2.00	1.20	1	0.65
MCFE1608TR10MG	RoHS	1.0	$\pm 20\%$	340	270	1.40	0.80	1	0.65
MCHK1608TR24MKN	RoHS	0.24	$\pm 20\%$	24	20	4.30	3.70	1	0.80
MCHK1608TR47MKN	RoHS	0.47	$\pm 20\%$	43	38	3.30	2.70	1	0.80
MCHK1608TR56MKN	RoHS	0.56	$\pm 20\%$	55	45	2.70	2.60	1	0.80
MCHK1608TR10MKN	RoHS	1.0	$\pm 20\%$	110	89	2.20	1.60	1	0.80
MCHK1608TR15MKN	RoHS	1.5	$\pm 20\%$	200	160	1.70	1.30	1	0.80
MCHK1608TR22MKN	RoHS	2.2	$\pm 20\%$	292	237	1.50	1.20	1	0.80
MCKK1608TR24M N	RoHS	0.24	$\pm 20\%$	38	35	2.80	2.60	1	1.00
MCKK1608TR47M N	RoHS	0.47	$\pm 20\%$	55	44	2.40	2.00	1	1.00
MCKK1608TR10M N	RoHS	1.0	$\pm 20\%$	123	100	2.00	1.30	1	1.00

## ● MC2012

Parts number	EHS	Nominal inductance [ $\mu$ H]	Inductance tolerance	DC Resistance [m $\Omega$ ]		Rated current(I <sub>dc1</sub> ) [A] (max.)	Rated current(I <sub>dc2</sub> ) [A] (max.)	Measuring frequency [MHz]	Thickness [mm] (max.)
				(max.)	(typ.)				
MCHK2012TR24M	RoHS	0.24	$\pm 20\%$	24	19	4.32	3.60	1	0.80
MCHK2012TR47M	RoHS	0.47	$\pm 20\%$	36	30	3.21	3.15	1	0.80
MCHK2012TR10M	RoHS	1.0	$\pm 20\%$	111	90	2.26	1.47	1	0.80
MCKK2012TR24M	RoHS	0.24	$\pm 20\%$	25	20	6.20	4.00	1	1.00
MCKK2012TR47M	RoHS	0.47	$\pm 20\%$	39	32	4.50	3.10	1	1.00
MCKK2012TR10M	RoHS	1.0	$\pm 20\%$	90	73	3.60	2.10	1	1.00

## ● MC2016

Parts number	EHS	Nominal inductance [ $\mu$ H]	Inductance tolerance	DC Resistance [m $\Omega$ ]		Rated current(I <sub>dc1</sub> ) [A] (max.)	Rated current(I <sub>dc2</sub> ) [A] (max.)	Measuring frequency [MHz]	Thickness [mm] (max.)
				(max.)	(typ.)				
MCFE2016TR47MJG B	RoHS	0.47	$\pm 20\%$	45	40	4.0	3.20	1	0.65
MCFE2016TR68MJG B	RoHS	0.68	$\pm 20\%$	60	50	3.0	2.50	1	0.65
MCFE2016TR10MJG B	RoHS	1.0	$\pm 20\%$	70	60	2.8	2.30	1	0.65

※I<sub>dc1</sub> is the DC value at which the initial L value is decreased within 30% by the application of DC bias. (at 20°C)

※I<sub>dc2</sub> is the DC value at which the temperature of element is increased within 40°C by the application of DC bias. (at 20°C)

# Multilayer chip inductors

Multilayer chip inductors for high frequency, Multilayer chip bead inductors

Multilayer common mode choke coils (MC series F type)

Metal Multilayer Chip Power Inductors (MCOIL™ MC series)

## ■ PACKAGING

### ① Minimum Quantity

#### ● Tape & Reel Packaging

Type	Thickness mm (inch)	Standard Quantity [pcs]	
		Paper Tape	Embossed Tape
CK 1608 (0603)	0.8 (0.031)	4000	—
CK 2125 (0805)	0.85 (0.033)	4000	—
	1.25 (0.049)	—	2000
CKS2125 (0805)	0.85 (0.033)	4000	—
	1.25 (0.049)	—	2000
CKP1608 (0603)	0.95 max (0.037 max)	4000	—
CKP2012 (0805)	1.0 max (0.039 max)	—	3000
CKP2016 (0806)	1.0 max (0.039 max)	—	3000
CKP2520 (1008)	0.8 max (0.031 max)	—	3000
	1.0 max (0.039 max)	—	3000
	1.2 max (0.047 max)	—	2000
LK 1005 (0402)	0.5 (0.020)	10000	—
LK 1608 (0603)	0.8 (0.031)	4000	—
LK 2125 (0805)	0.85 (0.033)	4000	—
	1.25 (0.049)	—	2000
HK 0603 (0201)	0.3 (0.012)	15000	—
HK 1005 (0402)	0.5 (0.020)	10000	—
HK 1608 (0603)	0.8 (0.031)	4000	—
HK 2125 (0805)	0.85 (0.033)	—	4000
	1.0 (0.039)	—	3000
HKQ0603S (0201)	0.3 (0.012)	15000	—
HKQ0603U (0201)	0.3 (0.012)	15000	—
AQ 105 (0402)	0.5 (0.020)	10000	—
BK 0603 (0201)	0.3 (0.012)	15000	—
BK 1005 (0402)	0.5 (0.020)	10000	—
BKH0603 (0201)	0.3 (0.012)	15000	—
BKH1005 (0402)	0.5 (0.020)	10000	—
BK 1608 (0603)	0.8 (0.031)	4000	—
BK 2125 (0805)	0.85 (0.033)	4000	—
	1.25 (0.049)	—	2000
BK 2010 (0804)	0.45 (0.018)	4000	—
BK 3216 (1206)	0.8 (0.031)	—	4000
BKP0603 (0201)	0.3 (0.012)	15000	—
BKP1005 (0402)	0.5 (0.020)	10000	—
BKP1608 (0603)	0.8 (0.031)	4000	—
BKP2125 (0805)	0.85 (0.033)	4000	—
MCF0605 (0202)	0.3 (0.012)	15000	—
MCF0806 (0302)	0.4 (0.016)	—	10000
MCF1210 (0504)	0.55 (0.022)	—	5000
MCF2010 (0804)	0.45 (0.018)	—	4000
MCEE1005 (0402)	0.55 max (0.022 max)	10000	—
MCEK1210 (0504)	0.5 max (0.020 max)	5000	—
MCFK1608 (0603)	0.6 max (0.024 max)	4000	—
MCFE1608 (0603)	0.65 max (0.026 max)	4000	—
MCHK1608 (0603)	0.8 max (0.031 max)	4000	—
MCKK1608 (0603)	1.0 max (0.039 max)	—	3000
MCHK2012 (0806)	0.8 max (0.031 max)	4000	—
MCKK2012 (0805)	1.0 max (0.039 max)	—	3000
MCFE2016 (0806)	0.65 max (0.026 max)	4000	—

► This catalog contains the typical specification only due to the limitation of space. When you consider the purchase of our products, please check our specification. For details of each product (characteristics graph, reliability information, precautions for use, and so on), see our Web site (<http://www.ty-top.com/>).

## ② Taping material

### ● Card board carrier tape

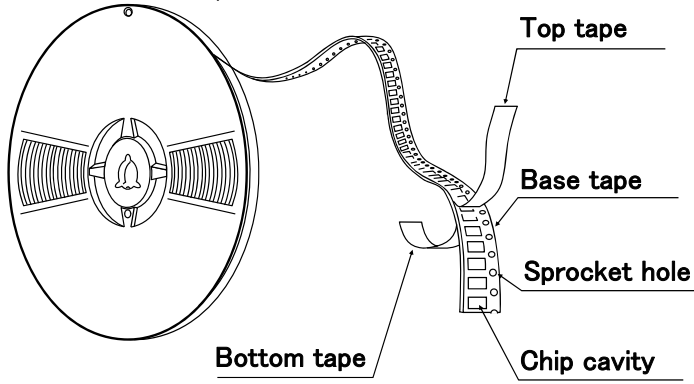

CK	1608
CKP	1608
CK	2125
CKS	2125
LK	1005
LK	1608
LK	2125
HK	0603
HK	1005
HK	1608
HKQ	0603
AQ	105

BK	0603
BK	1005
BK	1608
BK	2125
BK	2010
BKP	0603
BKP	1005
BKP	1608
BKP	2125
BKH	0603
BKH	1005
MCF	0605
MC	1005
MC	1210
MC	1608
MC	2012
MC	2016

### Chip Filled

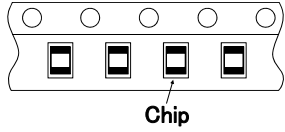

### ● Embossed Tape

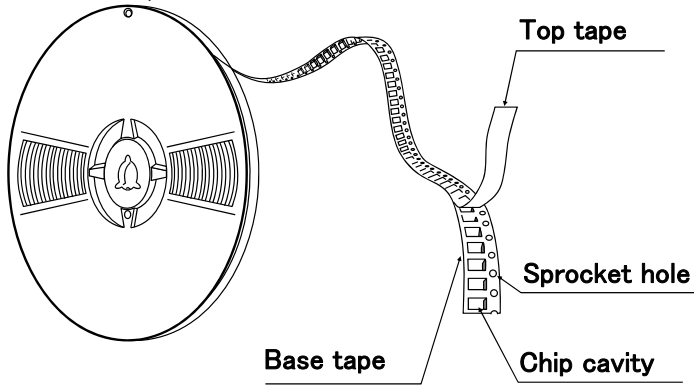

CK	2125
CKS	2125
CKP	2012
CKP	2016
CKP	2520
LK	2125
HK	2125

BK	2125
BK	3216
MCF	0806
MCF	1210
MCF	2010
MC	1608
MC	2012

### Chip Filled

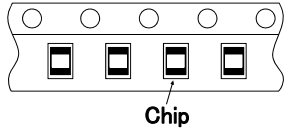

### ③ Taping Dimensions

● Paper tape (8mm wide)

Unit : mm (inch)

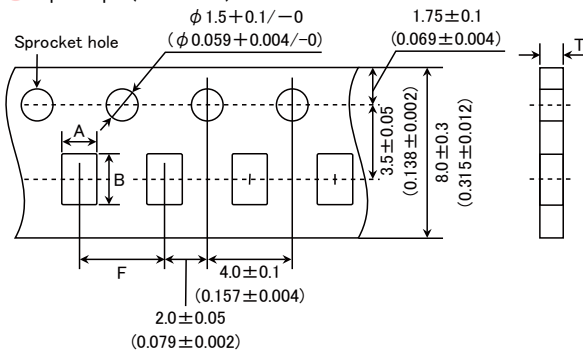

CK, CKS, CKP, LK, HK, HKQ, AQ, BK, BKP, BKH series

Type	Thickness	Chip cavity		Insertion Pitch F	Tape Thickness T
		A	B		
HK 0603 (0201) HKQ0603S (0201) HKQ0603U (0201) BK 0603 (0201) BKH0603 (0201) BKP0603 (0201)	0.3 (0.012)	0.40 (0.016)	0.70 (0.028)	2.0 ± 0.05 (0.079 ± 0.002)	0.45max (0.018max)
LK 1005 (0402) HK 1005 (0402) BK 1005 (0402) BKH1005 (0402) BKP1005 (0402)	0.5 (0.020)	0.65 (0.026)	1.15 (0.045)	2.0 ± 0.05 (0.079 ± 0.002)	0.8max (0.031max)
CK 1608 (0603) LK 1608 (0603) HK 1608 (0603) BK 1608 (0603) BKP1608 (0603)	0.8 (0.031)	1.0 (0.039)	1.8 (0.071)	4.0 ± 0.1 (0.157 ± 0.004)	1.1max (0.043max)
CKP1608 (0603)	0.95 max (0.037max)				
BK 2010 (0804)	0.45 (0.018)	1.2 (0.047)	2.17 (0.085)	4.0 ± 0.1 (0.157 ± 0.004)	0.8max (0.031max)
CK 2125 (0805) CKS2125 (0805) LK 2125 (0805) BK 2125 (0805) BKP2125 (0805)	0.85 (0.033)	1.5 (0.059)	2.3 (0.091)	4.0 ± 0.1 (0.157 ± 0.004)	1.1max (0.043max)
AQ 105 (0402)	0.5 (0.020)	0.75 (0.030)	1.15 (0.045)	2.0 ± 0.05 (0.079 ± 0.002)	0.8max (0.031max)

Unit : mm (inch)

MC series F type

Type	Thickness	Chip cavity		Insertion Pitch F	Tape Thickness T
		A	B		
MCF0605 (0202)	0.3 (0.012)	0.62 (0.024)	0.77 (0.030)	2.0 ± 0.05 (0.079 ± 0.002)	0.45max (0.018max)

Unit : mm (inch)

MCOIL™ MC series

Type	Thickness	Chip cavity		Insertion Pitch F	Tape Thickness T
		A	B		
MCEE1005 (0402)	0.55 max (0.021 max)	0.8 (0.031)	1.3 (0.051)	2.0 ± 0.05 (0.079 ± 0.002)	0.64max (0.025max)
MCEK1210 (0504)	0.5 max (0.020 max)	1.3 (0.051)	1.55 (0.061)	4.0 ± 0.1 (0.157 ± 0.004)	0.64max (0.025max)
MCFK1608 (0603)	0.6 max (0.024 max)	1.1 (0.043)	1.9 (0.075)	4.0 ± 0.1 (0.157 ± 0.004)	0.72max (0.028max)
MCFE1608 (0603)	0.65 max (0.026 max)	1.1 (0.043)	1.9 (0.075)	4.0 ± 0.1 (0.157 ± 0.004)	0.72max (0.028max)
MCHK1608 (0603)	0.8 max (0.031 max)	1.2 (0.047)	2.0 (0.079)	4.0 ± 0.1 (0.157 ± 0.004)	0.9max (0.035max)
MCHK2012 (0805)	0.8 max (0.031 max)	1.65 (0.065)	2.4 (0.094)	4.0 ± 0.1 (0.157 ± 0.004)	0.9max (0.035max)
MCFE2016 (0806)	0.65 max (0.026 max)	1.95 (0.077)	2.3 (0.091)	4.0 ± 0.1 (0.157 ± 0.004)	0.72max (0.028max)

Unit : mm (inch)

▶ This catalog contains the typical specification only due to the limitation of space. When you consider the purchase of our products, please check our specification. For details of each product (characteristics graph, reliability information, precautions for use, and so on), see our Web site (<http://www.ty-top.com/>).

● Embossed Tape (8mm wide)

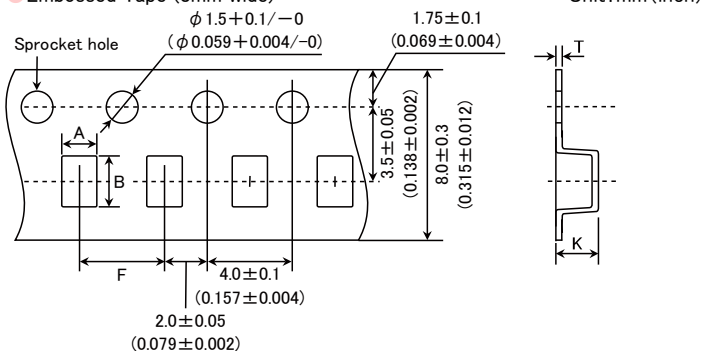

CK, CKS, CKP, LK, HK, BK series

Type	Thickness	Chip cavity		Insertion Pitch F	Tape Thickness	
		A	B		K	T
HK 2125 (0805)	0.85 (0.033)	1.5 (0.059)	2.3 (0.091)	4.0±0.1 (0.157±0.004)	1.5max (0.059 max)	0.3max (0.012 max)
	1.0 (0.039)				2.0 max (0.079 max)	
CK 2125 (0805) CKS2125 (0805) LK 2125 (0805) BK 2125 (0805)	1.25 (0.049)				2.0 max (0.079 max)	
BK 3216 (1206)	0.8 (0.031)	1.9 (0.075)	3.5 (0.138)	4.0±0.1 (0.157±0.004)	1.4 max (0.055 max)	0.3 max (0.012 max)
CKP2012 (0805)	1.0 max (0.039 max)	1.55 (0.061)	2.3 (0.091)	4.0±0.1 (0.157±0.004)	1.3 max (0.051 max)	0.3 max (0.012 max)
CKP2016 (0806)	1.0 max (0.039 max)	1.8 (0.071)	2.2 (0.087)	4.0±0.1 (0.157±0.004)	1.3 max (0.051 max)	0.25 max (0.01 max)
CKP2520 (1008)	0.8 max (0.031 max)	2.3 (0.091)	2.8 (0.110)	4.0±0.1 (0.157±0.004)	1.4 max (0.055 max)	0.3 max (0.012 max)
	1.0 max (0.039 max)				1.4 max (0.055 max)	
	1.2 max (0.047 max)				1.7 max (0.067 max)	

單位 : mm (inch)

MC series F type

Type	Thickness	Chip cavity		Insertion Pitch F	Tape Thickness	
		A	B		K	T
MCF0806 (0302)	0.4 (0.016)	0.75 (0.030)	0.95 (0.037)	2.0±0.05 (0.079±0.002)	0.55 max (0.022 max)	0.3 max (0.012 max)
MCF1210 (0504)	0.55 (0.022)	1.15 (0.045)	1.40 (0.055)	4.0±0.1 (0.157±0.004)	0.65 max (0.026 max)	0.3 max (0.012 max)
MCF2010 (0804)	0.45 (0.018)	1.1 (0.043)	2.3 (0.091)	4.0±0.1 (0.157±0.004)	0.85 max (0.033 max)	0.3 max (0.012 max)

Unit : mm (inch)

MCOIL™ MC series

Type	Thickness	Chip cavity		Insertion Pitch F	Tape Thickness	
		A	B		K	T
MCKK1608 (0603)	1.0 max (0.039 max)	1.1 (0.043)	1.95 (0.077)	4.0±0.1 (0.157±0.004)	1.5 max (0.059 max)	0.3 max (0.012 max)
MCKK2012 (0805)	1.0 max (0.039 max)	1.55 (0.061)	2.35 (0.093)	4.0±0.1 (0.157±0.004)	1.45 max (0.057 max)	0.3 max (0.012 max)

Unit : mm (inch)

#### ④ LEADER AND BLANK PORTION

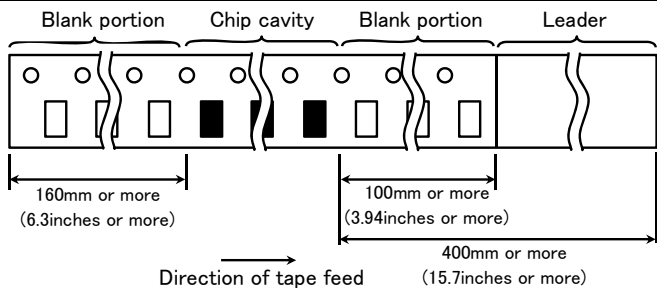

#### ⑤ Reel Size

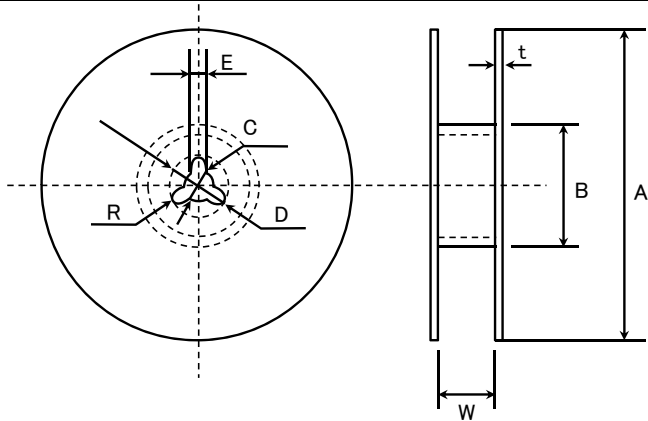

A	B	C	D	E	R
$\phi 178 \pm 2.0$	$\phi 50$ or more	$\phi 13.0 \pm 0.2$	$\phi 21.0 \pm 0.8$	$2.0 \pm 0.5$	1.0

	t	W
4mm width tape	1.5max.	$5 \pm 1.0$
8mm width tape	2.5max.	$10 \pm 1.5$

(Unit : mm)

#### ⑥ Top tape strength

The top tape requires a peel-off force of 0.1 to 0.7N (\*) in the direction of the arrow as illustrated below. \*) MCOIL™ MC series is 0.1 to 1.0N.

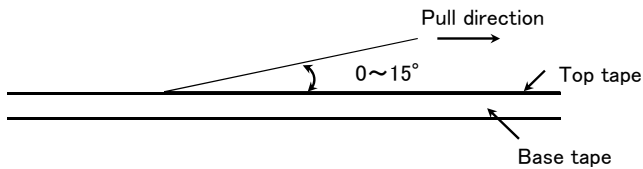



# Multilayer chip inductors

## Multilayer chip inductors for high frequency, Multilayer chip bead inductors

## Multilayer common mode choke coils (MC series F type)

## Metal Multilayer Chip Power Inductors (MCOIL™ MC series)

### RELIABILITY DATA

#### 1. Operating Temperature Range

Specified Value	BK series	-55 ~ +125°C
	BKH series	
	BKP series	-55 ~ +125°C (BKP0603: -55 ~ +85°C)
	MCF series	-40 ~ +85°C
	CK series	-40 ~ +85°C
	CKS series	
	CKP series	
	LK series	
	HK0603, HK1005	-55 ~ +125°C
	HK1608, HK2125	-40 ~ +85°C
	HKQ0603	-55 ~ +125°C
	AQ105	
MCOIL™ MC series	-40 ~ +125°C (Including self-generated heat)	

#### 2. Storage Temperature Range

Specified Value	BK series	-55 ~ +125°C
	BKH series	
	BKP series	-55 ~ +125°C (BKP0603: -55 ~ +85°C)
	MCF series	-40 ~ +85°C
	CK series	-40 ~ +85°C
	CKS series	
	CKP series	
	LK series	
	HK0603, HK1005	-55 ~ +125°C
	HK1608, HK2125	-40 ~ +85°C
	HKQ0603	-55 ~ +125°C
	AQ105	
MCOIL™ MC series	-40 ~ +85°C	

#### 3. Rated Current

Specified Value	BK series	The temperature of the element is increased within 20°C.
	BKH series	
	BKP series	The temperature of the element is increased within 40°C
	MCF series	Refer to each specification.
	CK series	The temperature of the element is increased within 20°C.
	CKS series	
	CKP series	The temperature of the element is increased within 40°C
	LK series	The decreasing-rate of inductance value is within 5 %
	HK0603, HK1005	The decreasing-rate of inductance value is within 5 %, or the temperature of the element is increased within 20°C
	HK1608, HK2125	
	HKQ0603	
	AQ105	
MCOIL™ MC series	Idc1: The decreasing-rate of inductance value is within 30 % Idc2: The temperature of the element is increased within 40°C	

4. Impedance		
Specified Value	BK series	Refer to each specification.
	BKH series	
	BKP series	
	MCF series	
Test Methods and Remarks	BK0603 series, BKP0603 series Measuring frequency : 100±1MHz Measuring equipment : 4991A (or its equivalent) Measuring jig : 16193A (or its equivalent), 16197A (or its equivalent)	
	BK(except 0603) series, BKP(except 0603) series Measuring frequency : 100±1MHz Measuring equipment : 4291A (or its equivalent), 4195A (or its equivalent) Measuring jig : 16192A (or its equivalent), HW: 16193A (or its equivalent)	
	BKH series Measuring frequency : 100±1MHz, 1GHz±1MHz Measuring equipment : 4991A (or its equivalent) Measuring jig : 16193A (or its equivalent), 16197A (or its equivalent)	
	MCF series Measuring frequency : 100±1MHz Measuring equipment : 4291A (or its equivalent)	

5. Inductance		
Specified Value	CK series	Refer to each specification.
	CKS series	
	CKP series	
	LK series	
	HK0603, HK1005	
	HK1608, HK2125	
	HKQ0603	
	AQ105	
	MCOIL™ MC series	
Test Methods and Remarks	CK, CKS, LK series Measuring frequency : Refer to each specification. Measuring equipment /jig : 1608,2125⇒4294A+16092A (or its equivalent) 1005⇒4291A+16193A (or its equivalent) Measuring current : 047~4.7 μH ⇒1mArms , 5.6~33 μH ⇒0.1mArms	
	CKP, MCOIL™ MC series Measuring frequency : 1MHz Measuring equipment : 4285A (or its equivalent)	
	HK0603, HK1005, AQ series Measuring frequency : 100MHz Measuring equipment /jig : HK0603⇒ E4991A+16197A (or its equivalent) , AQ105⇒4291A+16197A (or its equivalent) HK1005⇒ 4291A+16193A (or its equivalent)	
	HK1608, HK2125 series Measuring frequency : ~100nH⇒100MHz , 120nH~⇒50MHz Measuring equipment /jig : 4291A+16092A (or its equivalent)	
	HKQ series Measuring frequency : 500MHz Measuring equipment /jig : E4991A+16197A (or its equivalent)	

▶ This catalog contains the typical specification only due to the limitation of space. When you consider the purchase of our products, please check our specification.  
For details of each product (characteristics graph, reliability information, precautions for use, and so on), see our Web site (<http://www.ty-top.com/>).

6. Q		
Specified Value	LK series	Refer to each specification.
	HK0603, HK1005	
	HK1608, HK2125	
	HKQ0603	
	AQ105	
Test Methods and Remarks	LK series Measuring frequency : Refer to each specification. Measuring equipment /jig : 1608,2125⇒4294A+16092A(or its equivalent)、1005⇒4291A+16193A(or its equivalent) Measuring current : 047~4.7 μH ⇒1mArms、5.6~33 μH ⇒0.1mArms	
	HK0603, HK1005, AQ series Measuring frequency : 100MHz Measuring equipment /jig : HK0603⇒E4991A+16197A(or its equivalent)、AQ105⇒4291A+16197A(or its equivalent) HK1005⇒4291A+16193A(or its equivalent)	
	HK1608, HK2125 series Measuring frequency : ~100nH⇒100MHz、120nH~⇒50MHz Measuring equipment /jig : 4291A+16092A(or its equivalent)	
	HKQ series Measuring frequency : 500MHz Measuring equipment /jig : E4991A+16197A(or its equivalent)	

7. DC Resistance		
Specified Value	BK series	Refer to each specification.
	BKH series	
	BKP series	
	MCF series	
	CK series	
	CKS series	
	CKP series	
	LK series	
	HK0603, HK1005	
	HK1608, HK2125	
	HKQ0603	
	AQ105	
	MCOIL™ MC series	
Test Methods and Remarks	Measuring equipment: IWATSU VOAC7512, HIOKI RM3545 (or its equivalent)	

8. Self Resonance Frequency (SRF)		
Specified Value	CK series	Refer to each specification.
	CKS series	
	LK series	Refer to each specification.
	HK0603, HK1005	
	HK1608, HK2125	
	HKQ0603	
AQ105		
Test Methods and Remarks	LK, CK series : Measuring equipment : 4195A (or its equivalent) Measuring jig : 16092A (or its equivalent)	
	HK, HKQ, AQ series : Measuring equipment : 8719C (or its equivalent)	

9. Resistance to Flexure of Substrate		
Specified Value	BK series	No mechanical damage.
	BKH series	
	BKP series	
	MCF series	
	CK series	
	CKS series	
	CKP series	
	LK series	
	HK0603, HK1005	
	HK1608, HK2125	
	HKQ0603	
	AQ105	
MCOIL™ MC series		
Test Methods and Remarks	Warp : 2mm (BK series, BKP, BKH1005, CK, CKS, CKP, LK, HK, HKQ0603S, HKQ0603U, AQ series, MCF1210, MC series) : 1mm (BKH0603, MCF series without 1210 size,)	
	Testing board : glass epoxy-resin substrate Thickness : 0.8mm	
	<p>(Unit: mm)</p>	

10. Solderability		
Specified Value	BK series	At least 90% of terminal electrode is covered by new solder.
	BKH series	
	BKP series	
	MCF series	
	CK series	
	CKS series	
	CKP series	
	LK series	
	HK0603, HK1005	
	HK1608, HK2125	
	HKQ0603	
	AQ105	
MCOIL™ MC series		
Test Methods and Remarks	Solder temperature : 230±5°C (JIS Z 3282 H60A or H63A)	
	Solder temperature : 245±3°C (Sn/3.0Ag/0.5Cu)	
	Duration : 4±1 sec.	

11. Resistance to Soldering		
Specified Value	BK series	Appearance: No significant abnormality Impedance change: Within ±30%
	BKH series	
	BKP series	
	MCF series	Appearance: No significant abnormality Impedance change: Within ±20%
	CK series	Appearance: No significant abnormality Inductance change: R10~4R7⇒Within ±10%、6R8~100⇒Within ±15%
	CKS series	Appearance: No significant abnormality Inductance change: Within ±20%
	CKP series	Appearance: No significant abnormality Inductance change: Within ±30%
	LK series	Appearance: No significant abnormality Inductance change: 1005⇒Within ±15% 1608,2125⇒ 47N~4R7: Within ±10% 5R6~330: Within ±15%
	HK0603, HK1005	Appearance: No significant abnormality Inductance change: Within ±5%
	HK1608, HK2125	
	HKQ0603	
	AQ105	
MCOIL™ MC series	Appearance: No significant abnormality Inductance change: Within ±10%	

▶ This catalog contains the typical specification only due to the limitation of space. When you consider the purchase of our products, please check our specification.  
For details of each product (characteristics graph, reliability information, precautions for use, and so on), see our Web site (<http://www.ty-top.com/>).

Test Methods and Remarks	Solder temperature	: 260±5°C
	Duration	: 10±0.5 sec.
	Preheating temperature	: 150 to 180°C
	Preheating time	: 3 min.
	Flux	: Immersion into methanol solution with colophony for 3 to 5 sec.
Recovery	: 2 to 3 hrs of recovery under the standard condition after the test. (See Note 1)	

**12. Thermal Shock**

Specified Value	BK series	Appearance: No significant abnormality Impedance change: Within ±30%
	BKH series	
	BKP series	
	MCF series	Appearance: No significant abnormality Impedance change: Within ±20%
	CK series	Appearance: No significant abnormality Inductance change: Within ±20%
	CKS series	
	CKP series	Appearance: No significant abnormality Inductance change: Within ±30%
	LK series	Appearance: No significant abnormality Inductance change: Within ±10% Q change: Within ±30%
	HK0603, HK1005	Appearance: No significant abnormality Inductance change: Within ±10% Q change: Within ±20%
	HK1608, HK2125	
	HKQ0603	
	AQ105	
	MCOIL™ MC series	Appearance: No significant abnormality Inductance change: Within ±10%

Test Methods and Remarks	BK, BKP (0603 を除く)、BKH、HK0603、HK1005、HKQ、AQ series		
	Conditions for 1 cycle		
	Step	temperature (°C)	time (min.)
	1	-55 +0/-3	30±3
	2	Room temperature	2~3
	3	+125 +3/-0	30±3
	4	Room temperature	2~3
	Number of cycles: 5		
	Recovery: 2 to 3 hrs of recovery under the standard condition after the test. (See Note 1)		
	BKP0603 series		
Conditions for 1 cycle			
Step	temperature (°C)	time (min.)	
1	-55 +0/-3	30±3	
2	Room temperature	2~3	
3	+85 +3/-0	30±3	
4	Room temperature	2~3	
Number of cycles: 5			
Recovery: 2 to 3 hrs of recovery under the standard condition after the test. (See Note 1)			
MCF、CK、CKS、CKP、LK、HK1608、HK2125、MCOIL™ MC* series			
Conditions for 1 cycle			
Step	temperature (°C)	time (min.)	
1	-40 +0/-3	30±3	
2	Room temperature	2~3	
3	+85 +3/-0	30±3	
4	Room temperature	2~3	
Number of cycles: 5 (* MCOIL™ MC series: 100)			
Recovery: 2 to 3 hrs of recovery under the standard condition after the test. (See Note 1)			

▶ This catalog contains the typical specification only due to the limitation of space. When you consider the purchase of our products, please check our specification. For details of each product (characteristics graph, reliability information, precautions for use, and so on), see our Web site (<http://www.ty-top.com/>).

13. Damp Heat ( Steady state)		
Specified Value	BK series	Appearance: No significant abnormality Impedance change: Within $\pm 30\%$
	BKH series	
	BKP series	
	MCF series	Appearance: No significant abnormality Impedance change: Within $\pm 20\%$
	CK series	Appearance: No significant abnormality Inductance change: Within $\pm 20\%$
	CKS series	
	CKP series	Appearance: No significant abnormality Inductance change: Within $\pm 30\%$
	LK series	Appearance: No significant abnormality Inductance change: 1005,1608 $\Rightarrow$ Within $\pm 10\%$ 2125 $\Rightarrow$ Within $\pm 20\%$ Q change: Within $\pm 30\%$
	HK0603, HK1005	Appearance: No significant abnormality Inductance change: Within $\pm 10\%$ Q change: Within $\pm 20\%$
	HK1608, HK2125	
	HKQ0603	
	AQ105	
	MCOIL™ MC series	Appearance: No significant abnormality Inductance change: Within $\pm 10\%$
Test Methods and Remarks	BK, BKP, BKH, LK, CK, CKS, CKP, MCF series Temperature : $40 \pm 2^\circ\text{C}$ Humidity : 90 to 95%RH Duration : 500 +24/-0 hrs Recovery : 2 to 3 hrs of recovery under the standard condition after the removal from test chamber.(See Note 1)	
	HK, HKQ, AQ, MCOIL™ MC series Temperature : $60 \pm 2^\circ\text{C}$ Humidity : 90 to 95%RH Duration : 500 +24/-0 hrs Recovery : 2 to 3 hrs of recovery under the standard condition after the removal from test chamber.(See Note 1)	

14. Loading under Damp Heat		
Specified Value	BK series	Appearance: No significant abnormality Impedance change: Within $\pm 30\%$
	BKH series	
	BKP series	
	CK series	Appearance: No significant abnormality Inductance change: Within $\pm 20\%$
	CKS series	Appearance: No significant abnormality Inductance change: Within $\pm 30\%$
	CKP series	
	LK series	Appearance: No significant abnormality Inductance change: 1005 $\Rightarrow$ Within $\pm 10\%$ 1608 $\Rightarrow 0.047 \sim 12.0 \mu\text{H}$ : Within $\pm 10\%$ 15.0 $\sim 33.0 \mu\text{H}$ : Within $\pm 15\%$ 2125 $\Rightarrow$ Within $\pm 20\%$ Q change: Within $\pm 30\%$
	HK0603, HK1005	Appearance: No significant abnormality Inductance change: Within $\pm 10\%$ Q change: Within $\pm 20\%$
	HK1608, HK2125	
	HKQ0603	
	AQ105	
	MCOIL™ MC series	Appearance: No significant abnormality Inductance change: Within $\pm 10\%$
	Test Methods and Remarks	BK, BKP, BKH, LK, CK, CKS, CKP series Temperature : $40 \pm 2^\circ\text{C}$ Humidity : 90 to 95%RH Applied current : Rated current Duration : 500 +24/-0 hrs Recovery : 2 to 3 hrs of recovery under the standard condition after the removal from test chamber.(See Note 1)
HK, HKQ, AQ, MCOIL™ MC* series Temperature : $60 \pm 2^\circ\text{C}$ Humidity : 90 to 95%RH Applied current : Rated current (*MCOIL™ MC series ; Idc2max) Duration : 500 +24/-0 hrs Recovery : 2 to 3 hrs of recovery under the standard condition after the removal from test chamber.(See Note 1)		

▶ This catalog contains the typical specification only due to the limitation of space. When you consider the purchase of our products, please check our specification.  
For details of each product (characteristics graph, reliability information, precautions for use, and so on), see our Web site (<http://www.ty-top.com/>).

15. Loading at High Temperature		
Specified Value	BK series	Appearance: No significant abnormality Impedance change: Within $\pm 30\%$
	BKH series	
	BKP series	
	MCF series	Appearance: No significant abnormality Impedance change: Within $\pm 20\%$
	CK series	Appearance: No significant abnormality Inductance change: Within $\pm 20\%$
	CKS series	
	CKP series	Appearance: No significant abnormality Inductance change: Within $\pm 30\%$
	LK series	Appearance: No significant abnormality Inductance change: 1005 $\Rightarrow$ Within $\pm 10\%$ 1608 $\Rightarrow$ 0.047~12.0 $\mu$ H: Within $\pm 10\%$ 15.0~33.0 $\mu$ H: Within $\pm 15\%$ 2125 $\Rightarrow$ Within $\pm 20\%$ Q change: Within $\pm 30\%$
	HK0603, HK1005	Appearance: No significant abnormality Inductance change: Within $\pm 10\%$ Q change: Within $\pm 20\%$
	HK1608, HK2125	
	HKQ0603	
	AQ105	
	MCOIL™ MC series※	Appearance: No significant abnormality Inductance change: Within $\pm 10\%$
Test Methods and Remarks	BK, BKP (except 0603) *, BKH, HK0603, HK1005 *, HKQ, AQ series Temperature : 125 $\pm$ 2°C Applied current: Rated current (* BKP series and HK1005 series apply the rated current of 125°C.) Duration : 500 +24/-0 hrs Recovery : 2 to 3 hrs of recovery under the standard condition after the removal from test chamber. (See Note 1)	
	BKP0603, MCF, CK, CKS, CKP, LK, HK1608, HK2125, MCOIL™ MC** series Temperature : 85 $\pm$ 2°C Applied current: Rated current (** MCOIL™ MC series ; Idc2max) Duration : 500 +24/-0 hrs Recovery : 2 to 3 hrs of recovery under the standard condition after the removal from test chamber. (See Note 1)	

(Note 1) Measurement shall be made after 48 $\pm$ 2 hrs of recovery under the standard condition.

“standard condition” referred to herein is defined as follows:

5 to 35°C of temperature, 45 to 85% relative humidity.

When there are questions concerning measurement results:

In order to provide correlation data, the test shall be conducted under condition of 20 $\pm$ 2°C of temperature, 60 to 70% relative humidity, and 86 to 106kPa of air pressure. Unless otherwise specified, all the tests are conducted under the “standard condition.”

# Metal Multilayer Chip Power Inductors (MCOIL™ MC series)

## PRECAUTIONS

### 1. Circuit Design

#### Precautions

- ◆ Verification of operating environment, electrical rating and performance
  1. A malfunction in medical equipment, spacecraft, nuclear reactors, etc. may cause serious harm to human life or have severe social ramifications. As such, any inductors to be used in such equipment may require higher safety and/or reliability considerations and should be clearly differentiated from components used in general purpose applications.
  2. When inductors are used in places where dew condensation develops and/or where corrosive gas such as hydrogen sulfide, sulfurous acid, or chlorine exists in the air, characteristic deterioration may occur. Please do not use inductors under such environmental conditions.
- ◆ Operating Current (Verification of Rated current)
  1. The operating current including inrush current for inductors must always be lower than their rated values.
  2. Do not apply current in excess of the rated value because the inductance may be reduced due to the magnetic saturation effect.
- ◆ Temperature rise
 

Temperature rise of power choke coil depends on the installation condition in end products.

Make sure that temperature rise of power choke coils in actual end products is within the specified temperature range.

### 2. PCB Design

#### Precautions

- ◆ Pattern configurations (Design of Land-patterns)
 

When inductors are mounted on a PCB, the size of land patterns and the amount of solder used (size of fillet) can directly affect inductor performance. Therefore, the following items must be carefully considered in the design of solder land patterns:

  - (1) The amount of solder applied can affect the ability of chips to withstand mechanical stresses which may lead to breaking or cracking. Therefore, when designing land-patterns it is necessary to consider the appropriate size and configuration of the solder pads which in turn determines the amount of solder necessary to form the fillets.
  - (2) When more than one part is jointly soldered onto the same land or pad, the pad must be designed so that each component's soldering point is separated by solder-resist.
- ◆ Pattern configurations (Inductor layout on panelized [breakaway] PC boards)
 

After inductors have been mounted on the boards, chips can be subjected to mechanical stresses in subsequent manufacturing processes (PCB cutting, board inspection, mounting of additional parts, assembly into the chassis, wave soldering the reflow soldered boards etc.) For this reason, planning pattern configurations and the position of SMD inductors should be carefully performed to minimize stress.

- ◆ Pattern configurations (Design of Land-patterns)
 

The following diagrams and tables show some examples of recommended patterns to prevent excessive solder amounts. Examples of improper pattern designs are also shown.

(1) Recommended land dimensions for a typical chip inductor land patterns for PCBs

(Unit: mm)

Type	1005	1210	1608 (Except MCHK)	1608 (MCHK)	2012	2016
A	0.4	0.45	0.45	0.65	0.5	0.7
B	0.5	0.6	1.0	0.6	1.2	0.8
C	0.7	1.15	1.0	1.0	1.45	1.8

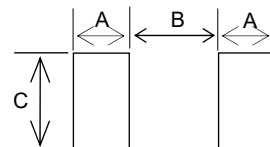

(2) Examples of good and bad solder application

#### Technical considerations

Item	Not recommended	Recommended
Mixed mounting of SMD and leaded components	<p>Lead wire of component</p>	<p>Solder-resist</p>
Component placement close to the chassis	<p>Chassis Solder (for grounding) Electrode pattern</p>	<p>Solder-resist</p>
Hand-soldering of leaded components near mounted components	<p>Lead wire of component Soldering iron</p>	<p>Solder-resist</p>



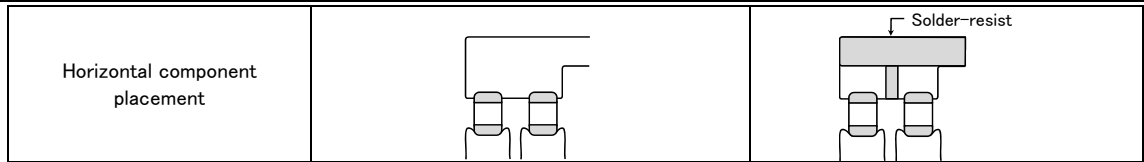

◆Pattern configurations(Inductor layout on panelized[ breakaway] PC boards)

1. The following are examples of good and bad inductor layout; SMD inductors should be located to minimize any possible mechanical stresses from board warp or deflection.

Item	Not recommended	Recommended
Deflection of the board		 Position the component at a right angle to the direction of the mechanical stresses that are anticipated.

2. To layout the inductors for the breakaway PC board, it should be noted that the amount of mechanical stresses given will vary depending on inductor layout.

An example below should be counted for better design.

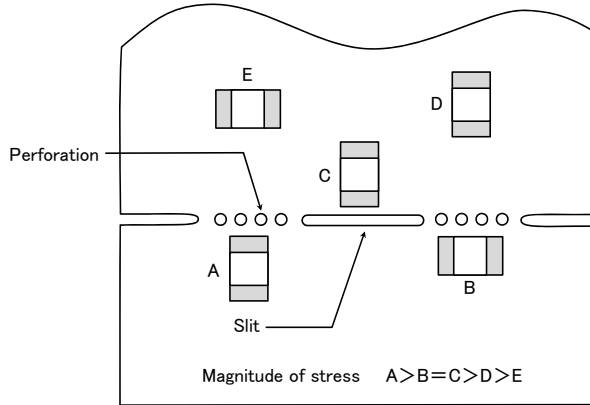

3. When breaking PC boards along their perforations, the amount of mechanical stress on the inductors can vary according to the method used. The following methods are listed in order from least stressful to most stressful: push-back, slit, V-grooving, and perforation. Thus, any ideal SMD inductor layout must also consider the PCB splitting procedure.

3. Considerations for automatic placement

Precautions

◆Adjustment of mounting machine

- Excessive impact load should not be imposed on the inductors when mounting onto the PC boards.
- The maintenance and inspection of the moulder should be conducted periodically.

Technical considerations

◆Adjustment of mounting machine

- If the lower limit of the pick-up nozzle is low, too much force may be imposed on the inductors, causing damage. To avoid this, the following points should be considered before lowering the pick-up nozzle:
  - The lower limit of the pick-up nozzle should be adjusted to the surface level of the PC board after correcting for deflection of the board.
  - The pick-up pressure should be adjusted between 1 and 3N static loads.
  - To reduce the amount of deflection of the board caused by impact of the pick-up nozzle, supporting pins or back-up pins should be used under the PC board. The following diagrams show some typical examples of good pick-up nozzle placement:

Item	Improper method	Proper method
Single-sided mounting		
Double-sided mounting		

2. As the alignment pin wears out, adjustment of the nozzle height can cause chipping or cracking of the inductors because of mechanical impact on the inductors. To avoid this, the monitoring of the width between the alignment pin in the stopped position, and maintenance, inspection and replacement of the pin should be conducted periodically.

► This catalog contains the typical specification only due to the limitation of space. When you consider the purchase of our products, please check our specification. For details of each product (characteristics graph, reliability information, precautions for use, and so on), see our Web site (<http://www.ty-top.com/>).

#### 4. Soldering

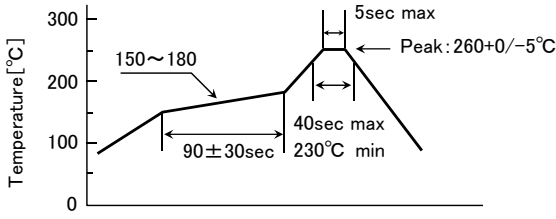
<p>Precautions</p>	<ul style="list-style-type: none"> <li>◆Reflow soldering           <ul style="list-style-type: none"> <li>• Please contact any of our offices for a reflow soldering, and refer to the recommended condition specified.</li> <li>• The product shall be used reflow soldering only.</li> <li>• Please do not add any stress to a product until it returns in normal temperature after reflow soldering.</li> </ul> </li> <li>◆Lead free soldering           <ul style="list-style-type: none"> <li>• When using products with lead free soldering, we request to use them after confirming adhesion, temperature of resistance to soldering heat, soldering etc sufficiently.</li> </ul> </li> <li>◆The conditions for Reworking with soldering irons           <ul style="list-style-type: none"> <li>• Put the soldering iron on the land-pattern and don't touch it to the inductor directly.</li> <li>• Soldering iron's temperature below 350 degC , Duration 3 seconds or less</li> </ul> </li> </ul>
<p>Technical considerations</p>	<ul style="list-style-type: none"> <li>◆Reflow soldering           <ul style="list-style-type: none"> <li>• If products are used beyond the range of the recommended conditions, heat stresses may deform the products, and consequently degrade the reliability of the products.</li> </ul> </li> </ul> <p style="text-align: center;">Recommended reflow condition (Pb free solder)</p>  <p style="text-align: center;">The allowable number of reflow soldering is 3 times.</p>

#### 5. Cleaning

<p>Precautions</p>	<ul style="list-style-type: none"> <li>◆Cleaning conditions           <ul style="list-style-type: none"> <li>• Washing by supersonic waves shall be avoided.</li> </ul> </li> </ul>
<p>Technical considerations</p>	<ul style="list-style-type: none"> <li>◆Cleaning conditions           <ul style="list-style-type: none"> <li>• If washed by supersonic waves, the products might be broken.</li> </ul> </li> </ul>

#### 6. Resin coating and mold

<p>Precautions</p>	<ol style="list-style-type: none"> <li>1. With some type of resins a decomposition gas or chemical reaction vapor may remain inside the resin during the hardening period or while left under normal storage conditions resulting in the deterioration of the inductor's performance.</li> <li>2. Thermal expansion and thermal shrinkage characteristics of resins may lead to the deterioration of inductors' performance.</li> <li>3. When a resin hardening temperature is higher than inductor operating temperature, the stresses generated by the excessive heat may lead to damage in inductors.</li> <li>4. In prior to use, please make the reliability evaluation with the product mounted in your application set.</li> </ol>
--------------------	---

#### 7. Handling

<p>Precautions</p>	<ul style="list-style-type: none"> <li>◆Breakaway PC boards (splitting along perforations)           <ol style="list-style-type: none"> <li>1. When splitting the PC board after mounting inductors and other components, care is required so as not to give any stresses of deflection or twisting to the board.</li> <li>2. Board separation should not be done manually, but by using the appropriate devices.</li> </ol> </li> <li>◆General handling precautions           <ul style="list-style-type: none"> <li>• Always wear static control bands to protect against ESD.</li> <li>• Keep the inductors away from all magnets and magnetic objects.</li> <li>• Use non-magnetic tweezers when handling inductors.</li> <li>• Any devices used with the inductors ( soldering irons, measuring instruments) should be properly grounded.</li> <li>• Keep bare hands and metal products (i.e., metal desk) away from inductor electrodes or conductive areas that lead to chip electrodes.</li> <li>• Keep inductors away from items that generate magnetic fields such as speakers or coils.</li> </ul> </li> <li>◆Mechanical considerations           <ul style="list-style-type: none"> <li>• Be careful not to subject the inductors to excessive mechanical shocks.               <ol style="list-style-type: none"> <li>(1) If inductors are dropped on the floor or a hard surface they should not be used.</li> <li>(2) When handling the mounted boards, be careful that the mounted components do not come in contact with or bump against other boards or components.</li> </ol> </li> </ul> </li> </ul>
--------------------	--

## 8. Storage conditions

Precautions	<p>◆Storage To maintain the solderability of terminal electrodes and to keep the packaging material in good condition, care must be taken to control temperature and humidity in the storage area. Humidity should especially be kept as low as possible.</p> <ul style="list-style-type: none"><li>•Recommended conditions Ambient temperature: 30°C or below    Humidity: 70% RH or below</li></ul> <p>The ambient temperature must be kept below 40°C. Even under ideal storage conditions, solderability of inductor is deteriorated as time passes, so inductors should be used within 6 months from the time of delivery.</p> <ul style="list-style-type: none"><li>•Inductor should be kept where no chlorine or sulfur exists in the air.</li></ul>
Technical considerations	<p>◆Storage If the parts are stocked in a high temperature and humidity environment, problems such as reduced solderability caused by oxidation of terminal electrodes and deterioration of taping/package materials may take place. For this reason, components should be used within 6 months from the time of delivery. If exceeding the above period, please check solderability before using the inductors.</p>

## X-ON Electronics

Largest Supplier of Electrical and Electronic Components

*Click to view similar products for [Fixed Inductors](#) category:*

*Click to view products by [Taiyo Yuden](#) manufacturer:*

Other Similar products are found below :

[CR43NP-680KC](#) [CR54NP-820KC](#) [CR54NP-8R5MC](#) [CTX32CT-100](#) [70F224AI](#) [MGDQ4-00004-P](#) [MHL1ECTTP18NJ](#) [MHL1JCTTD12NJ](#)  
[PE-51506NL](#) [PE-53601NL](#) [PE-53602NL](#) [PE-53630NL](#) [PE-53824SNLT](#) [PE-62892NL](#) [PE-92100NL](#) [PG0434.801NLT](#) [PG0936.113NLT](#)  
[9310-16](#) [PM06-2N7](#) [PM06-39NJ](#) [A01TK](#) [1206CS-471XJ](#) [HC2-2R2TR](#) [HC2LP-R47-R](#) [HC3-2R2-R](#) [1206CS-151XG](#) [RCH664NP-140L](#)  
[RCH664NP-4R7M](#) [RCH8011NP-221L](#) [RCP1317NP-332L](#) [RCP1317NP-391L](#) [RCR1010NP-470M](#) [RCR110DNP-331L](#) [DH2280-4R7M](#)  
[DS1608C-106](#) [ASPI-4020HI-R10M-T](#) [B10TJ](#) [B82477P4333M](#) [B82498B3101J000](#) [B82498B3680J000](#) [ELJ-RE27NJF2](#) [1812CS-153XJ](#)  
[1812CS-183XJ](#) [1812CS-223XJ](#) [1812LS-104XJ](#) [1812LS-105XJ](#) [1812LS-124XJ](#) [1812LS-154XJ](#) [1812LS-223XJ](#) [1812LS-224XJ](#)