

Notice for TAIYO YUDEN Products

Please read this notice before using the TAIYO YUDEN products.



REMINDERS

■ Product Information in this Catalog

Product information in this catalog is as of October 2021. All of the contents specified herein and production status of the products listed in this catalog are subject to change without notice due to technical improvement of our products, etc. Therefore, please check for the latest information carefully before practical application or use of our products.

Please note that TAIYO YUDEN shall not be in any way responsible for any damages and defects in products or equipment incorporating our products, which are caused under the conditions other than those specified in this catalog or individual product specification sheets.

■ Approval of Product Specifications

Please contact TAIYO YUDEN for further details of product specifications as the individual product specification sheets are available. When using our products, please be sure to approve our product specifications or make a written agreement on the product specification with TAIYO YUDEN in advance.

■ Pre-Evaluation in the Actual Equipment and Conditions

Please conduct validation and verification of our products in actual conditions of mounting and operating environment before using our products.

■ Safety Design

When using our products for high safety and/or reliability-required equipment or circuits, please fully perform safety and/or reliability evaluation. In addition, please install (i) systems equipped with a protection circuit and a protection device and/or (ii) systems equipped with a redundant circuit or other system to prevent an unsafe status in the event of a single fault for a failsafe design to ensure safety.

■ Intellectual Property Rights

Information contained in this catalog is intended to convey examples of typical performances and/or applications of our products and is not intended to make any warranty with respect to the intellectual property rights or any other related rights of TAIYO YUDEN or any third parties nor grant any license under such rights.

■ Limited Warranty

Please note that the scope of warranty for our products is limited to the delivered our products themselves conforming to the product specifications specified in the individual product specification sheets, and TAIYO YUDEN shall not be in any way responsible for any damages resulting from a failure or defect in our products. Notwithstanding the foregoing, if there is a written agreement (e.g., supply and purchase agreement, quality assurance agreement) signed by TAIYO YUDEN and your company, TAIYO YUDEN will warrant our products in accordance with such agreement, provided, however, that our products shall be used for general-purpose and standard use in the equipment specified in this catalog or the individual product specification sheets.

■ TAIYO YUDEN's Official Sales Channel

The contents of this catalog are applicable to our products which are purchased from our sales offices or authorized distributors (hereinafter "TAIYO YUDEN's official sales channel"). Please note that the contents of this catalog are not applicable to our products purchased from any seller other than TAIYO YUDEN's official sales channel.

■ Caution for Export

Some of our products listed in this catalog may require specific procedures for export according to "U.S. Export Administration Regulations", "Foreign Exchange and Foreign Trade Control Law" of Japan, and other applicable regulations. Should you have any questions on this matter, please contact our sales staff.

■ Limited Application

1. Equipment Intended for Use

The products listed in this catalog are intended for general-purpose and standard use in general electronic equipment for consumer (e.g., AV equipment, OA equipment, home electric appliances, office equipment, information and communication equipment including, without limitation, mobile phone, and PC) and other equipment specified in this catalog or the individual product specification sheets, or the equipment approved separately by TAIYO YUDEN.

TAIYO YUDEN has the product series intended for use in the following equipment. Therefore, when using our products for these equipment, please check available applications specified in this catalog or the individual product specification sheets and use the corresponding products.

Application	Product Series		Quality Grade ^{*3}
	Equipment ^{*1}	Category (Part Number Code ^{*2})	
Automotive	Automotive Electronic Equipment (POWERTRAIN, SAFETY)	A	1
	Automotive Electronic Equipment (BODY & CHASSIS, INFOTAINMENT)	C	2
Industrial	Telecommunications Infrastructure and Industrial Equipment	B	2
Medical	Medical Devices classified as GHTF Class C (Japan Class III)	M	2
	Medical Devices classified as GHTF Classes A or B (Japan Classes I or II)	L	3
Consumer	General Electronic Equipment	S	3

*Notes: 1. Based on the general specifications required for electronic components for such equipment, which are recognized by TAIYO YUDEN, the use of each product series for the equipment is recommended. Please be sure to contact TAIYO YUDEN before using our products for equipment other than those covered by the product series.

2. On each of our part number, the 2nd code from the left is a code indicating the "Category" as shown in the above table. For details, please check the explanatory materials regarding the part numbering system of each of our products.

3. Each product series is assigned a "Quality Grade" from 1 to 3 in order of higher quality. Please do not incorporate a product into any equipment with a higher Quality Grade than the Quality Grade of such product without the prior written consent of TAIYO YUDEN.

2. Equipment Requiring Inquiry

Please be sure to contact TAIYO YUDEN for further information before using the products listed in this catalog for the following equipment (excluding intended equipment as specified in this catalog or the individual product specification sheets) which may cause loss of human life, bodily injury, serious property damage and/or serious public impact due to a failure or defect of the products and/or malfunction attributed thereto.

- (1) Transportation equipment (automotive powertrain control system, train control system, and ship control system, etc.)
- (2) Traffic signal equipment
- (3) Disaster prevention equipment, crime prevention equipment
- (4) Medical devices classified as GHTF Class C (Japan Class III)
- (5) Highly public information network equipment, data-processing equipment (telephone exchange, and base station, etc.)
- (6) Any other equipment requiring high levels of quality and/or reliability equal to the equipment listed above

3. Equipment Prohibited for Use

Please do not incorporate our products into the following equipment requiring extremely high levels of safety and/or reliability.

- (1) Aerospace equipment (artificial satellite, rocket, etc.)
- (2) Aviation equipment ^{*1}
- (3) Medical devices classified as GHTF Class D (Japan Class IV), implantable medical devices ^{*2}
- (4) Power generation control equipment (nuclear power, hydroelectric power, thermal power plant control system, etc.)
- (5) Undersea equipment (submarine repeating equipment, etc.)
- (6) Military equipment
- (7) Any other equipment requiring extremely high levels of safety and/or reliability equal to the equipment listed above

*Notes: 1. There is a possibility that our products can be used only for aviation equipment that does not directly affect the safe operation of aircraft (e.g., in-flight entertainment, cabin light, electric seat, cooking equipment) if such use meets requirements specified separately by TAIYO YUDEN. Please be sure to contact TAIYO YUDEN for further information before using our products for such aviation equipment.

2. Implantable medical devices contain not only internal unit which is implanted in a body, but also external unit which is connected to the internal unit.

4. Limitation of Liability

Please note that unless you obtain prior written consent of TAIYO YUDEN, TAIYO YUDEN shall not be in any way responsible for any damages incurred by you or third parties arising from use of the products listed in this catalog for any equipment that is not intended for use by TAIYO YUDEN, or any equipment requiring inquiry to TAIYO YUDEN or prohibited for use by TAIYO YUDEN as described above.

Multilayer Ceramic Capacitors for General Electronic Equipment for Consumer

REFLOW

PART NUMBER

M	S	A	S	U	3	1	L	B	B	5	1	0	6	K	T	N	A	0	1
①	②	③	④	⑤	⑥	⑦	⑧	⑨	⑩										

①Series

Code (1)(2)(3)(4)	
MSAS	Multilayer Ceramic Capacitor (High dielectric type) for General Electronic Equipment for Consumer Multilayer Ceramic Capacitor (Temperature compensating type) for General Electronic Equipment for Consumer Medium-High Voltage Multilayer Ceramic Capacitor for General Electronic Equipment for Consumer
MSAR	High frequency/Low loss Multilayer Ceramic Capacitor for General Electronic Equipment for Consumer
MSAY	Low distortion design/Audible/Good bias Multilayer Ceramic Capacitor for General Electronic Equipment for Consumer
MSRL	LW Reversal Decoupling Low ESL Capacitor (LWDC™) for General Electronic Equipment for Consumer

(1) Product Group

Code	
M	Multilayer Ceramic Capacitor

(2) Category

Code	Recommended equipment	Quality Grade
S	General Electronic Equipment for Consumer	3

(3) Type

Code	
A	2 terminals
R	LW reversal

(4) Features, Characteristics

Code	
S	Standard/General
R	High frequency/Low loss
Y	Low distortion design/Audible/Good bias
L	Low ESL

②Rated voltage

Code	Rated voltage [VDC]
P	2.5
A	4
J	6.3
L	10
E	16
T	25
G	35
U	50
H	100
Q	250
S	630
X	2000

④Thickness

Code	Thickness [mm]
1	0.125
H	0.13 (1.5 max ※)
E	0.18 (1.1 max ※)
2	0.2
3	0.3
K	0.45
5	0.5
8	0.8
9	0.85
Q	1.15
G	1.25
L	1.6
N	1.9 (0.088 ※)
Y	2.0 max
M	2.5

Note : ※LW reverse type (MSRL)

③Dimension

Code	(L × W) [mm]	JIS(mm)	EIA(inch)
02	0.25 × 0.125	0201	008004
04	0.4 × 0.2	0402	01005
06	0.6 × 0.3	0603	0201
1L	1.0 × 0.5	1005	0402
10	1.0 × 0.5	1005	0402
	0.52 × 1.0 ※	0510	0204
16	1.6 × 0.8	1608	0603
	0.8 × 1.6 ※	0816	0306
21	2.0 × 1.25	2012	0805
	1.25 × 2.0 ※	1220	0508
31	3.2 × 1.6	3216	1206
32	3.2 × 2.5	3225	1210
45	4.5 × 3.2	4532	1812

Note : ※LW reverse type (MSRL)

⑤Dimension tolerance

Code	Dimension code	L[mm]	W[mm]	T[mm]	Thickness code
A	06	0.6±0.05	0.3±0.05	0.3±0.05	3
	10	1.0±0.10	0.5±0.10	0.5±0.10	5
	16	1.6+0.15/-0.05	0.8+0.15/-0.05	0.8+0.15/-0.05	8
	21	2.0+0.15/-0.05	1.25+0.15/-0.05	1.25+0.15/-0.05	G
	31	3.2±0.20	1.6±0.20	1.6±0.20	L
	32	3.2±0.30	2.5±0.30	2.5±0.30	M
	45	4.5±0.40	3.2±0.30	2.0+0/-0.30	Y
B	06	0.6±0.09	0.3±0.09	0.3±0.09	3
	10	1.0+0.15/-0.05	0.5+0.15/-0.05	0.5+0.15/-0.05	5
	16	1.6+0.20/-0	0.8+0.20/-0	0.8+0.20/-0	8
	21	2.0+0.20/-0	1.25+0.20/-0	1.25+0.20/-0	G
	31	3.2±0.30	1.6±0.30	1.6±0.30	L
	32	3.2±0.30	2.5±0.20	1.9+0.1/-0.20	Y
C	10	1.0+0.20/-0	0.5+0.20/-0	0.5+0.20/-0	5
E	06	0.6+0.25/-0	0.3+0.25/-0	0.3+0.25/-0	3
	10	1.0+0.30/-0	0.5+0.30/-0	0.5+0.30/-0	5
H	31	3.2±0.15	1.6±0.15	0.85±0.10	9
				1.15±0.10	Q
J	16	1.6+0.20/-0	0.8+0.20/-0	0.45±0.05	K
	21	2.0+0.15/-0.05	1.25+0.15/-0.05	0.85±0.10	9
	32	3.2±0.30	2.5±0.20	0.85±0.10	9
				1.15±0.10	Q
L	21	2.0+0.20/-0	1.25+0.20/-0	0.85±0.10	9
	31	3.2±0.20	1.6±0.20	0.85±0.10	9
S	02	0.25±0.013	0.125±0.013	0.125±0.013	1
		0.4±0.02	0.2±0.02	0.2±0.02	2
		0.6±0.03	0.3±0.03	0.3±0.03	3
	10	1.0±0.05	0.5±0.05	0.5±0.05	5
		0.52±0.05 ※	1.0±0.05	0.3±0.05	3
	16	1.6±0.10	0.8±0.10	0.8±0.10	8
		0.8±0.10 ※	1.6±0.10	0.5±0.05	5
	21	2.0±0.10	1.25±0.10	0.85±0.10	9
		1.25±0.15 ※	2.0±0.15	1.25±0.10	G
				0.85±0.10	9
	31	3.2±0.15	1.6±0.15	1.6±0.20	L
	32	3.2±0.30	2.5±0.20	2.5±0.20	M
				1.9±0.20	N
				2.5±0.20	M
45	4.5±0.40	3.2±0.30	2.5±0.20	M	
T	16	1.6±0.10	0.8±0.10	0.45±0.05	K
X	1L	1.0±0.05	0.5±0.05	0.13±0.02	H
				0.18±0.02	E
				0.2±0.02	2
Y	1L	1.0±0.05	0.5±0.05	0.3±0.03	3

Note :※LW reverse type (MSRL)

⑥ Temperature characteristics code

■ High dielectric type (SD: Excluding Low distortion design/Audible/Good bias Multilayer Ceramic Capacitor)

Code	Applicable standard		Temperature range [°C]	Ref. Temp. [°C]	Capacitance change	Capacitance tolerance	Tolerance code
B5	JIS	B	-25 ~ + 85	20	±10%	±10%	K
						±20%	M
	EIA	X5R	-55 ~ + 85	25	±15%	±10%	K
						±20%	M
B7	EIA	X7R	-55 ~ +125	25	±15%	±10%	K
						±20%	M
C6	EIA	X6S	-55 ~ +105	25	±22%	±10%	K
						±20%	M
C7	EIA	X7S	-55 ~ +125	25	±22%	±10%	K
						±20%	M
LD(※)	EIA	X5R	-55 ~ + 85	25	±15%	±10%	K
						±20%	M

Note : ※.LD: Low distortion design/Audible/Good bias Multilayer Ceramic Capacitor

■ Temperature compensating type

Code	Applicable standard		Temperature range [°C]	Ref. Temp. [°C]	Capacitance change	Capacitance tolerance	Tolerance code
CG	JIS	CG	-55 ~ +125	20	0 ± 30ppm/°C	±0.05pF	A
						±0.1pF	B
	±0.25pF	C					
	EIA	C0G		25		±0.5pF	D
						±2%	G
					±5%	J	
CH	JIS	CH	-55 ~ +125	20	0 ± 60ppm/°C	±0.05pF	A
						±0.1pF	B
	±0.25pF	C					
	EIA	C0H		25		±0.5pF	D
						±2%	G
					±5%	J	
CJ	JIS	CJ	-55 ~ +125	20	0 ± 120ppm/°C	±0.05pF	A
				25		±0.1pF	B
	EIA	C0J				±0.25pF	C
CK	JIS	CK	-55 ~ +125	20	0 ± 250ppm/°C	±0.05pF	A
				25		±0.1pF	B
	EIA	C0K				±0.25pF	C

⑥ Series code

• Low distortion design/Audible/Good bias Multilayer Ceramic Capacitor

Code	Series code
SD	Standard

• Medium-High Voltage Multilayer Ceramic Capacitor

Code	Series code
SD	Standard

⑦ Nominal capacitance

Code (example)	Nominal capacitance
0R5	0.5pF
010	1pF
100	10pF
101	100pF
102	1,000pF
103	0.01μF
104	0.1μF
105	1μF
106	10μF
107	100μF

Note : R=Decimal point

⑧ Capacitance tolerance

Code	Capacitance tolerance
A	±0.05pF
B	±0.1pF
C	±0.25pF
D	±0.5pF
G	±2%
J	±5%
K	±10%
M	±20%

⑨ Packaging

Code	Packaging
F	φ178mm Taping (2mm pitch)
T	φ178mm Taping (4mm pitch)
P	φ178mm Taping (4mm pitch, 1000 pcs/reel) 3225 type (Thickness code M)
R	φ178mm Embossed Taping 1005type (2mm pitch) 1608type (4mm pitch)
W	φ178mm Embossed Taping (1mm pitch) 0201/0402type

⑩ Internal code

STANDARD EXTERNAL DIMENSIONS

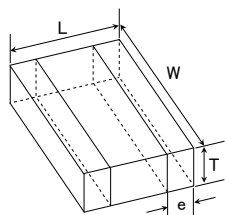
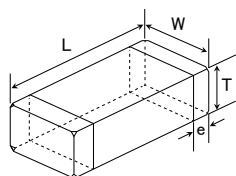

※LW reverse type

Type	JIS (mm)	EIA (inch)	Dimension [mm]				
			L	W	T	*1	e
MSAS□02	0201	008004	0.25±0.013	0.125±0.013	0.125±0.013	1	0.0675±0.0275
MSAR□02	0201	008004	0.25±0.013	0.125±0.013	0.125±0.013	1	0.0675±0.0275
MSAS□04	0402	01005	0.4±0.02	0.2±0.02	0.2±0.02	2	0.1±0.03
MSAR□04	0402	01005	0.4±0.02	0.2±0.02	0.2±0.02	2	0.1±0.03
MSAS□06	0603	0201	0.6±0.03	0.3±0.03	0.3±0.03	3	0.15±0.05
MSAS□1L	1005	0402	1.0±0.05	0.5±0.05	0.13±0.02	H	0.25±0.10
					0.18±0.02	E	
					0.2±0.02	2	
					0.3±0.03	3	
MSAS□10	1005	0402	1.0±0.05	0.5±0.05	0.5±0.05	5	0.25±0.10
MSAY□1L	1005	0402	1.0±0.05	0.5±0.05	0.3±0.03	3	0.25±0.10
MSAY□10	1005	0402	1.0±0.05	0.5±0.05	0.5±0.05	5	0.25±0.10
MSRL□10 ※	0510	0204	0.52±0.05	1.0±0.05	0.3±0.05	3	0.18±0.08
MSAS□16	1608	0603	1.6±0.10	0.8±0.10	0.45±0.05	K	0.35±0.25
					0.8±0.10	8	
MSAY□16	1608	0603	1.6±0.10	0.8±0.10	0.8±0.10	8	0.35±0.25
MSRL□16 ※	0816	0306	0.8±0.10	1.6±0.10	0.5±0.05	5	0.25±0.15
MSAS□21	2012	0805	2.0±0.10	1.25±0.10	0.85±0.10	9	0.5±0.25
					1.25±0.10	G	
MSRL□21 ※	1220	0508	1.25±0.15	2.0±0.15	0.85±0.10	9	0.3±0.2
MSAS□31	3216	1206	3.2±0.15	1.6±0.15	0.85±0.10	9	0.5+0.35/-0.25
					1.15±0.10	Q	
					1.6±0.20	L	
MSAY□31	3216	1206	3.2±0.15	1.6±0.15	1.15±0.10	Q	0.5+0.35/-0.25
					1.6±0.20	L	
MSAS□32	3225	1210	3.2±0.30	2.5±0.20	0.85±0.10	9	0.6±0.3
					1.15±0.10	Q	
					1.9±0.20	N	
					1.9+0.1/-0.20	Y	
MSAY□32	3225	1210	3.2±0.30	2.5±0.20	2.5±0.20	M	0.6±0.3
					1.9±0.20	N	
MSAS□45	4532	1812	4.5±0.40	3.2±0.30	2.0+0/-0.30	Y	0.6±0.4
					2.5±0.20	M	

Note :※LW reverse type (MSRL), *1.Thickness code

■ STANDARD QUANTITY

Type			Thickness		Standard quantity [pcs]	
Code	JIS(mm)	EIA(inch)	[mm]	Code	Paper tape	Embossed tape
02	0201	008004	0.125	1	—	50000
04	0402	01005	0.2	2	—	40000
06	0603	0201	0.3	3	15000	—
1L	1005	0402	0.13	H	—	20000
			0.18	E	—	15000
			0.2	2	20000	—
			0.3	3	15000	—
10	1005	0402	0.5	5	10000	—
	0510 ※	0204 ※	0.3	3		
16	1608	0603	0.45	K	4000	—
			0.8	8		
	0816 ※	0306 ※	0.5	5	—	4000
21	2012	0805	0.85	9	4000	—
			1.25	G	—	3000
	1220 ※	0508 ※	0.85	9	4000	—
31	3216	1206	0.85	9	4000	—
			1.15	Q	—	3000
			1.6	L	—	2000
32	3225	1210	0.85	9	—	2000
			1.15	Q		
			1.9	N		
			2.0 max	Y		
			2.5	M		
45	4532	1812	2.0 max	Y	—	1000
			2.5	M	—	500

Note : ※:LW Reverse type (MSRL)

PARTS NUMBER

- All the Multilayer Ceramic Capacitors of the catalog lineup are RoHS Compliant.
- Capacitance tolerance code is applied to □ of part number.
- All the Multilayer Ceramic Capacitors in the catalog lineup are applicable for reflow-soldering. Please contact us for flow compatible products.

Note)
 *1 We may provide X7R/X7S for some items according to the individual specification.
 *2 The exchange of individual specification is necessary depending on the application and circuit condition. Please contact TAIYO YUDEN sales channels.
 *3 The size standard should look at Dimension, Thickness, Dimension tolerance, and STANDARD EXTERNAL DIMENSIONS.

Multilayer Ceramic Capacitors (High dielectric type) for General Electronic Equipment for Consumer

0201TYPE

【Temperature Characteristic B5(BJ) : X5R(-55~+85°C)】 0.125mm thickness

New part number	Old part number (for reference)	Rated voltage [V]	Temperature characteristics		Capacitance [F]	Capacitance tolerance [%]	tan δ [%]	HTLT	Thickness*3 [mm]	Note
								Rated voltage x %		
MSASE021SB5221□WNA01	EMK021 BJ221□K-W	16		X5R	220 p	±10, ±20	10	150	0.125±0.013	
MSASE021SB5471□WNA01	EMK021 BJ471□K-W	16		X5R	470 p	±10, ±20	10	150	0.125±0.013	
MSASE021SB5102□WNA01	EMK021 BJ102□K-W	16		X5R	1000 p	±10, ±20	10	150	0.125±0.013	
MSASJ021SB5222□WNA01	JMK021 BJ222□K-W	6.3		X5R	2200 p	±10, ±20	10	150	0.125±0.013	
MSASJ021SB5472□WNA01	JMK021 BJ472□K-W	6.3		X5R	4700 p	±10, ±20	10	150	0.125±0.013	
MSASJ021SB5103□WNA01	JMK021 BJ103□K-W	6.3		X5R	0.01 μ	±10, ±20	10	150	0.125±0.013	
MSASA021SB5223MWNA01	AMK021 BJ223MK-W	4		X5R	0.022 μ	±20	10	150	0.125±0.013	

0402TYPE

【Temperature Characteristic B5(BJ) : B(-25~+85°C)/X5R(-55~+85°C)】 0.2mm thickness

New part number	Old part number (for reference)	Rated voltage [V]	Temperature characteristics		Capacitance [F]	Capacitance tolerance [%]	tan δ [%]	HTLT	Thickness*3 [mm]	Note
								Rated voltage x %		
MSASE042SB5101□WNA01	EMK042 BJ101□C-W	16		X5R	100 p	±10, ±20	5	200	0.2±0.02	
MSASE042SB5151□WNA01	EMK042 BJ151□C-W	16		X5R	150 p	±10, ±20	5	200	0.2±0.02	
MSASE042SB5221□WNA01	EMK042 BJ221□C-W	16		X5R	220 p	±10, ±20	5	200	0.2±0.02	
MSASE042SB5331□WNA01	EMK042 BJ331□C-W	16		X5R	330 p	±10, ±20	5	200	0.2±0.02	
MSASE042SB5471□WNA01	EMK042 BJ471□C-W	16		X5R	470 p	±10, ±20	5	200	0.2±0.02	
MSASE042SB5681□WNA01	EMK042 BJ681□C-W	16		X5R	680 p	±10, ±20	5	200	0.2±0.02	
MSASE042SB5102□WNA01	EMK042 BJ102□C-W	16	B	X5R	1000 p	±10, ±20	5	200	0.2±0.02	
MSASE042SB5152□WNA01	EMK042 BJ152□C-W	16		X5R	1500 p	±10, ±20	10	150	0.2±0.02	
MSASE042SB5222□WNA01	EMK042 BJ222□C-W	16		X5R	2200 p	±10, ±20	10	150	0.2±0.02	
MSASE042SB5332□WNA01	EMK042 BJ332□C-W	16		X5R	3300 p	±10, ±20	10	150	0.2±0.02	
MSASE042SB5472□WNA01	EMK042 BJ472□C-W	16		X5R	4700 p	±10, ±20	10	150	0.2±0.02	
MSASE042SB5682□WNA01	EMK042 BJ682□C-W	16		X5R	6800 p	±10, ±20	10	150	0.2±0.02	
MSASE042SB5103□WNA01	EMK042 BJ103□C-W	16		X5R	0.01 μ	±10, ±20	10	150	0.2±0.02	
MSASL042SB5101□WNA01	LMK042 BJ101□C-W	10		X5R ^{*1}	100 p	±10, ±20	5	200	0.2±0.02	
MSASL042SB5151□WNA01	LMK042 BJ151□C-W	10		X5R ^{*1}	150 p	±10, ±20	5	200	0.2±0.02	
MSASL042SB5221□WNA01	LMK042 BJ221□C-W	10		X5R ^{*1}	220 p	±10, ±20	5	200	0.2±0.02	
MSASL042SB5331□WNA01	LMK042 BJ331□C-W	10		X5R ^{*1}	330 p	±10, ±20	5	200	0.2±0.02	
MSASL042SB5471□WNA01	LMK042 BJ471□C-W	10		X5R ^{*1}	470 p	±10, ±20	5	200	0.2±0.02	
MSASL042SB5681□WNA01	LMK042 BJ681□C-W	10		X5R ^{*1}	680 p	±10, ±20	5	200	0.2±0.02	
MSASL042SB5102□WNA01	LMK042 BJ102□C-W	10	B	X5R ^{*1}	1000 p	±10, ±20	5	200	0.2±0.02	
MSASL042SB5152□WNA01	LMK042 BJ152□C-W	10		X5R	1500 p	±10, ±20	10	150	0.2±0.02	
MSASL042SB5222□WNA01	LMK042 BJ222□C-W	10		X5R	2200 p	±10, ±20	10	150	0.2±0.02	
MSASL042SB5332□WNA01	LMK042 BJ332□C-W	10		X5R	3300 p	±10, ±20	10	150	0.2±0.02	
MSASL042SB5472□WNA01	LMK042 BJ472□C-W	10		X5R	4700 p	±10, ±20	10	150	0.2±0.02	
MSASL042SB5682□WNA01	LMK042 BJ682□C-W	10		X5R	6800 p	±10, ±20	10	150	0.2±0.02	
MSASL042SB5103□WNA01	LMK042 BJ103□C-W	10		X5R	0.01 μ	±10, ±20	10	150	0.2±0.02	
MSASJ042SB5152□WNA01	JMK042 BJ152□C-W	6.3		X5R ^{*1}	1500 p	±10, ±20	10	150	0.2±0.02	
MSASJ042SB5222□WNA01	JMK042 BJ222□C-W	6.3		X5R ^{*1}	2200 p	±10, ±20	10	150	0.2±0.02	
MSASJ042SB5332□WNA01	JMK042 BJ332□C-W	6.3		X5R ^{*1}	3300 p	±10, ±20	10	150	0.2±0.02	
MSASJ042SB5472□WNA01	JMK042 BJ472□C-W	6.3		X5R ^{*1}	4700 p	±10, ±20	10	150	0.2±0.02	
MSASJ042SB5682□WNA01	JMK042 BJ682□C-W	6.3		X5R ^{*1}	6800 p	±10, ±20	10	150	0.2±0.02	
MSASJ042SB5103□WNA01	JMK042 BJ103□C-W	6.3		X5R ^{*1}	0.01 μ	±10, ±20	10	150	0.2±0.02	
MSASJ042SB5223□WNA01	JMK042 BJ223□C-W	6.3		X5R	0.022 μ	±10, ±20	10	150	0.2±0.02	
MSASJ042SB5473□WNA01	JMK042 BJ473□C-W	6.3		X5R	0.047 μ	±10, ±20	10	150	0.2±0.02	
MSASJ042SB5104□WNA01	JMK042 BJ104□C-W	6.3		X5R	0.1 μ	±10, ±20	10	150	0.2±0.02	
MSASA042SB5473□WNA01	AMK042 BJ473□C-W	4		X5R	0.047 μ	±10, ±20	10	150	0.2±0.02	
MSASA042SB5104□WNA01	AMK042 BJ104□C-W	4		X5R	0.1 μ	±10, ±20	10	150	0.2±0.02	

▶ This catalog contains the typical specification only due to the limitation of space. When you consider the purchase of our products, please check our specification.
 For details of each product (characteristics graph, reliability information, precautions for use, and so on), see our Web site (<http://www.ty-top.com/>).

PARTS NUMBER

【Temperature Characteristic B7 : X7R (−55~+125°C)】 0.2mm thickness

New part number	Old part number (for reference)	Rated voltage [V]	Temperature characteristics		Capacitance [F]	Capacitance tolerance [%]	tan δ [%]	HTLT	Thickness ^{*3} [mm]	Note
								Rated voltage x %		
MSASE042SB7101□WNA01	EMK042 B7101□C-W	16		X7R	100 p	±10, ±20	5	200	0.2±0.02	
MSASE042SB7151□WNA01	EMK042 B7151□C-W	16		X7R	150 p	±10, ±20	5	200	0.2±0.02	
MSASE042SB7221□WNA01	EMK042 B7221□C-W	16		X7R	220 p	±10, ±20	5	200	0.2±0.02	
MSASE042SB7331□WNA01	EMK042 B7331□C-W	16		X7R	330 p	±10, ±20	5	200	0.2±0.02	
MSASE042SB7471□WNA01	EMK042 B7471□C-W	16		X7R	470 p	±10, ±20	5	200	0.2±0.02	
MSASE042SB7681□WNA01	EMK042 B7681□C-W	16		X7R	680 p	±10, ±20	5	200	0.2±0.02	
MSASE042SB7102□WNA01	EMK042 B7102□C-W	16		X7R	1000 p	±10, ±20	5	200	0.2±0.02	
MSASL042SB7101□WNA01	LMK042 B7101□C-W	10		X7R	100 p	±10, ±20	5	200	0.2±0.02	
MSASL042SB7151□WNA01	LMK042 B7151□C-W	10		X7R	150 p	±10, ±20	5	200	0.2±0.02	
MSASL042SB7221□WNA01	LMK042 B7221□C-W	10		X7R	220 p	±10, ±20	5	200	0.2±0.02	
MSASL042SB7331□WNA01	LMK042 B7331□C-W	10		X7R	330 p	±10, ±20	5	200	0.2±0.02	
MSASL042SB7471□WNA01	LMK042 B7471□C-W	10		X7R	470 p	±10, ±20	5	200	0.2±0.02	
MSASL042SB7681□WNA01	LMK042 B7681□C-W	10		X7R	680 p	±10, ±20	5	200	0.2±0.02	
MSASL042SB7102□WNA01	LMK042 B7102□C-W	10		X7R	1000 p	±10, ±20	5	200	0.2±0.02	

0603TYPE

【Temperature Characteristic B5(BJ) : B(−25~+85°C)/X5R(−55~+85°C)】 0.3mm thickness

New part number	Old part number (for reference)	Rated voltage [V]	Temperature characteristics		Capacitance [F]	Capacitance tolerance [%]	tan δ [%]	HTLT	Thickness ^{*3} [mm]	Note
								Rated voltage x %		
MSASU063SB5101□FNA01	UMK063 BJ101□P-F	50	B	X5R ^{*1}	100 p	±10, ±20	3.5	200	0.3±0.03	
MSASU063SB5151□FNA01	UMK063 BJ151□P-F	50	B	X5R ^{*1}	150 p	±10, ±20	3.5	200	0.3±0.03	
MSASU063SB5221□FNA01	UMK063 BJ221□P-F	50	B	X5R ^{*1}	220 p	±10, ±20	3.5	200	0.3±0.03	
MSASU063SB5331□FNA01	UMK063 BJ331□P-F	50	B	X5R ^{*1}	330 p	±10, ±20	3.5	200	0.3±0.03	
MSASU063SB5471□FNA01	UMK063 BJ471□P-F	50	B	X5R ^{*1}	470 p	±10, ±20	3.5	200	0.3±0.03	
MSASU063SB5681□FNA01	UMK063 BJ681□P-F	50	B	X5R ^{*1}	680 p	±10, ±20	3.5	200	0.3±0.03	
MSASU063SB5102□FNA01	UMK063 BJ102□P-F	50	B	X5R ^{*1}	1000 p	±10, ±20	3.5	200	0.3±0.03	
MSASU063SB5152□FNA01	UMK063 BJ152□P-F	50	B	X5R	1500 p	±10, ±20	5	200	0.3±0.03	
MSASU063SB5222□FNA01	UMK063 BJ222□P-F	50	B	X5R	2200 p	±10, ±20	5	200	0.3±0.03	
MSASU063SB5332□FNA01	UMK063 BJ332□P-F	50	B	X5R	3300 p	±10, ±20	5	200	0.3±0.03	
MSASU063SB5472□FNA01	UMK063 BJ472□P-F	50	B	X5R	4700 p	±10, ±20	5	200	0.3±0.03	
MSASU063SB5682□FNA01	UMK063 BJ682□P-F	50	B	X5R	6800 p	±10, ±20	5	200	0.3±0.03	
MSASU063SB5103□FNA01	UMK063 BJ103□P-F	50	B	X5R	0.01 μ	±10, ±20	5	200	0.3±0.03	
MSASG063SB5104□FNA01	GMK063 BJ104□P-F	35		X5R	0.1 μ	±10, ±20	10	150	0.3±0.03	
MSAST063SB5152□FNA01	TMK063 BJ152□P-F	25	B	X5R	1500 p	±10, ±20	5	200	0.3±0.03	
MSAST063SB5222□FNA01	TMK063 BJ222□P-F	25	B	X5R	2200 p	±10, ±20	5	200	0.3±0.03	
MSAST063SB5332□FNA01	TMK063 BJ332□P-F	25	B	X5R	3300 p	±10, ±20	5	200	0.3±0.03	
MSAST063SB5472□FNA01	TMK063 BJ472□P-F	25	B	X5R	4700 p	±10, ±20	5	200	0.3±0.03	
MSAST063SB5682□FNA01	TMK063 BJ682□P-F	25	B	X5R	6800 p	±10, ±20	5	200	0.3±0.03	
MSAST063SB5103□FNA01	TMK063 BJ103□P-F	25	B	X5R	0.01 μ	±10, ±20	5	200	0.3±0.03	
MSAST063SB5223□FNA01	TMK063 BJ223□P-F	25	B	X5R	0.022 μ	±10, ±20	7.5	200	0.3±0.03	
MSAST063AB5104□FNA01	TMK063ABJ104□P-F	25		X5R	0.1 μ	±10, ±20	10	150	0.3±0.05	
MSASE063SB5152□FNA01	EMK063 BJ152□P-F	16	B	X5R ^{*1}	1500 p	±10, ±20	5	200	0.3±0.03	
MSASE063SB5222□FNA01	EMK063 BJ222□P-F	16	B	X5R ^{*1}	2200 p	±10, ±20	5	200	0.3±0.03	
MSASE063SB5332□FNA01	EMK063 BJ332□P-F	16	B	X5R ^{*1}	3300 p	±10, ±20	5	200	0.3±0.03	
MSASE063SB5472□FNA01	EMK063 BJ472□P-F	16	B	X5R ^{*1}	4700 p	±10, ±20	5	200	0.3±0.03	
MSASE063SB5682□FNA01	EMK063 BJ682□P-F	16	B	X5R ^{*1}	6800 p	±10, ±20	5	200	0.3±0.03	
MSASE063SB5103□FNA01	EMK063 BJ103□P-F	16	B	X5R ^{*1}	0.01 μ	±10, ±20	5	200	0.3±0.03	
MSASE063SB5223□FNA01	EMK063 BJ223□P-F	16	B	X5R	0.022 μ	±10, ±20	7.5	200	0.3±0.03	
MSASE063SB5333□FNA01	EMK063 BJ333□P-F	16		X5R	0.033 μ	±10, ±20	7.5	150	0.3±0.03	
MSASE063SB5473□FNA01	EMK063 BJ473□P-F	16		X5R	0.047 μ	±10, ±20	7.5	150	0.3±0.03	
MSASE063SB5683□FNA01	EMK063 BJ683□P-F	16		X5R	0.068 μ	±10, ±20	10	150	0.3±0.03	
MSASE063SB5104□FNA01	EMK063 BJ104□P-F	16		X5R	0.1 μ	±10, ±20	10	150	0.3±0.03	
MSASE063SB5224□FNA01	EMK063 BJ224□P-F	16		X5R	0.22 μ	±10, ±20	10	150	0.3±0.03	
MSASE063BB5474□FNB33	EMK063BBJ474□PLF	16		X5R	0.47 μ	±10, ±20	10	150	0.3±0.09	
MSASL063SB5223□FNA01	LMK063 BJ223□P-F	10	B	X5R	0.22 μ	±10, ±20	7.5	150	0.3±0.03	
MSASL063SB5333□FNA01	LMK063 BJ333□P-F	10		X5R	0.033 μ	±10, ±20	7.5	150	0.3±0.03	
MSASL063SB5473□FNA01	LMK063 BJ473□P-F	10		X5R	0.047 μ	±10, ±20	7.5	150	0.3±0.03	
MSASL063SB5683□FNA01	LMK063 BJ683□P-F	10		X5R	0.068 μ	±10, ±20	10	150	0.3±0.03	
MSASL063SB5104□FNA01	LMK063 BJ104□P-F	10		X5R	0.1 μ	±10, ±20	10	150	0.3±0.03	
MSASL063SB5224□FNA01	LMK063 BJ224□P-F	10		X5R	0.22 μ	±10, ±20	10	150	0.3±0.03	
MSASL063BB5474□FNB33	LMK063BBJ474□PLF	10		X5R	0.47 μ	±10, ±20	10	150	0.3±0.09	
MSASL063BB5105MFNB33	LMK063BBJ105MPLF	10		X5R	1 μ	±20	10	150	0.3±0.09	
MSASJ063SB5104□FNA01	JMK063 BJ104□P-F	6.3		X5R	0.1 μ	±10, ±20	10	150	0.3±0.03	
MSASJ063SB5224□FNA01	JMK063 BJ224□P-F	6.3		X5R	0.22 μ	±10, ±20	10	150	0.3±0.03	
MSASJ063SB5334MFNA01	JMK063 BJ334MP-F	6.3		X5R	0.33 μ	±20	10	150	0.3±0.03	
MSASJ063SB5474□FNA01	JMK063 BJ474□P-F	6.3		X5R	0.47 μ	±10, ±20	10	150	0.3±0.03	
MSASJ063AB5105□FNA01	JMK063ABJ105□P-F	6.3		X5R	1 μ	±10, ±20	10	150	0.3±0.05	
MSASA063EB5475MFNA01	AMK063EBJ475MP-F	4		X5R	4.7 μ	±20	10	150	0.3+0.25/-0	
MSASP063EB5475MFNA01	PMK063EBJ475MP-F	2.5		X5R	4.7 μ	±20	10	150	0.3+0.25/-0	

PARTS NUMBER

【Temperature Characteristic C6 : X6S (−55~+105°C)】 0.3mm thickness

New part number	Old part number (for reference)	Rated voltage [V]	Temperature characteristics	Capacitance [F]	Capacitance tolerance [%]	tan δ [%]	HTLT		Thickness ^{*3} [mm]	Note
							Rated voltage x %			
MSAST063SC6104[FNA01]	TMK063 C6104[P-F]	25	X6S	0.1 μ	±10, ±20	10	150		0.3±0.03	
MSASE063AC6104[FNA01]	EMK063AC6104[P-F]	16	X6S	0.1 μ	±10, ±20	10	150		0.3±0.05	
MSASL063SC6104[FNA01]	LMK063 C6104[P-F]	10	X6S	0.1 μ	±10, ±20	10	150		0.3±0.03	
MSASL063SC6224[FNA01]	LMK063 C6224[P-F]	10	X6S	0.22 μ	±10, ±20	10	150		0.3±0.03	
MSASL063BC6474[FNB33]	LMK063BC6474[PLF]	10	X6S	0.47 μ	±10, ±20	10	150		0.3±0.09	
MSASJ063SC6104[FNA01]	JMK063 C6104[P-F]	6.3	X6S	0.1 μ	±10, ±20	10	150		0.3±0.03	
MSASJ063SC6224[FNA01]	JMK063 C6224[P-F]	6.3	X6S	0.22 μ	±10, ±20	10	150		0.3±0.03	
MSASJ063BC6474[FNA01]	JMK063BC6474[P-F]	6.3	X6S	0.47 μ	±10, ±20	10	150		0.3±0.09	
MSASJ063BC6105MFNA01	JMK063BC6105MP-F	6.3	X6S	1 μ	±20	10	150		0.3±0.09	
MSASA063SC6474[FNA01]	AMK063 C6474[P-F]	4	X6S	0.47 μ	±10, ±20	10	150		0.3±0.03	
MSASA063AC6105[FNA01]	AMK063AC6105[P-F]	4	X6S	1 μ	±10, ±20	10	150		0.3±0.05	

【Temperature Characteristic B7 : X7R (−55~+125°C)】 0.3mm thickness

New part number	Old part number (for reference)	Rated voltage [V]	Temperature characteristics	Capacitance [F]	Capacitance tolerance [%]	tan δ [%]	HTLT		Thickness ^{*3} [mm]	Note
							Rated voltage x %			
MSASU063SB7101[FNA01]	UMK063 B7101[P-F]	50	X7R	100 p	±10, ±20	3.5	200		0.3±0.03	
MSASU063SB7151[FNA01]	UMK063 B7151[P-F]	50	X7R	150 p	±10, ±20	3.5	200		0.3±0.03	
MSASU063SB7221[FNA01]	UMK063 B7221[P-F]	50	X7R	220 p	±10, ±20	3.5	200		0.3±0.03	
MSASU063SB7331[FNA01]	UMK063 B7331[P-F]	50	X7R	330 p	±10, ±20	3.5	200		0.3±0.03	
MSASU063SB7471[FNA01]	UMK063 B7471[P-F]	50	X7R	470 p	±10, ±20	3.5	200		0.3±0.03	
MSASU063SB7681[FNA01]	UMK063 B7681[P-F]	50	X7R	680 p	±10, ±20	3.5	200		0.3±0.03	
MSASU063SB7102[FNA01]	UMK063 B7102[P-F]	50	X7R	1000 p	±10, ±20	3.5	200		0.3±0.03	
MSAST063SB7152[FNA01]	TMK063 B7152[P-F]	25	X7R	1500 p	±10, ±20	5	200		0.3±0.03	
MSAST063SB7222[FNA01]	TMK063 B7222[P-F]	25	X7R	2200 p	±10, ±20	5	200		0.3±0.03	
MSAST063SB7332[FNA01]	TMK063 B7332[P-F]	25	X7R	3300 p	±10, ±20	5	200		0.3±0.03	
MSAST063SB7472[FNA01]	TMK063 B7472[P-F]	25	X7R	4700 p	±10, ±20	5	200		0.3±0.03	
MSAST063SB7682[FNA01]	TMK063 B7682[P-F]	25	X7R	6800 p	±10, ±20	5	200		0.3±0.03	
MSAST063SB7103[FNA01]	TMK063 B7103[P-F]	25	X7R	0.01 μ	±10, ±20	5	200		0.3±0.03	
MSASE063SB7152[FNA01]	EMK063 B7152[P-F]	16	X7R	1500 p	±10, ±20	5	200		0.3±0.03	
MSASE063SB7222[FNA01]	EMK063 B7222[P-F]	16	X7R	2200 p	±10, ±20	5	200		0.3±0.03	
MSASE063SB7332[FNA01]	EMK063 B7332[P-F]	16	X7R	3300 p	±10, ±20	5	200		0.3±0.03	
MSASE063SB7472[FNA01]	EMK063 B7472[P-F]	16	X7R	4700 p	±10, ±20	5	200		0.3±0.03	
MSASE063SB7682[FNA01]	EMK063 B7682[P-F]	16	X7R	6800 p	±10, ±20	5	200		0.3±0.03	
MSASE063SB7103[FNA01]	EMK063 B7103[P-F]	16	X7R	0.01 μ	±10, ±20	5	200		0.3±0.03	
MSASE063SB7223[FNA01]	EMK063 B7223[P-F]	16	X7R	0.022 μ	±10, ±20	7.5	150		0.3±0.03	

1005TYPE

【Temperature Characteristic B5(BJ) : B (−25~+85°C)/X5R (−55~+85°C)】 0.5mm thickness

New part number	Old part number (for reference)	Rated voltage [V]	Temperature characteristics	Capacitance [F]	Capacitance tolerance [%]	tan δ [%]	HTLT		Thickness ^{*3} [mm]	Note
							Rated voltage x %			
MSASU105SB5223[FNA01]	UMK105 BJ223[V-F]	50	X5R	0.022 μ	±10, ±20	5	200		0.5±0.05	
MSASU105SB5473[FNA01]	UMK105 BJ473[V-F]	50	X5R	0.047 μ	±10, ±20	5	200		0.5±0.05	
MSASU105SB5104[FNA01]	UMK105 BJ104[V-F]	50	X5R	0.1 μ	±10, ±20	10	150		0.5±0.05	
MSASU105SB5224[FNA01]	UMK105 BJ224[V-F]	50	X5R	0.22 μ	±10, ±20	10	150		0.5±0.05	
MSASU105AB5474[FNA01]	UMK105ABJ474[V-F]	50	X5R	0.47 μ	±10, ±20	10	150		0.5±0.10	
MSASU105CB5105[FNA01]	UMK105CBJ105[V-F]	50	X5R	1 μ	±10, ±20	10	150		0.5+0.20/-0	
MSASG105SB5104[FNA01]	GMK105 BJ104[V-F]	35	B	X5R	0.1 μ	±10, ±20	5	150	0.5±0.05	
MSASG105AB5105[FNA01]	GMK105ABJ105[V-F]	35	X5R	1 μ	±10, ±20	10	150		0.5±0.10	
MSAST105SB5153[FNA01]	TMK105 BJ153[V-F]	25	B	X5R ^{*1}	0.015 μ	±10, ±20	3.5	200	0.5±0.05	
MSAST105SB5223[FNA01]	TMK105 BJ223[V-F]	25	B	X5R ^{*1}	0.022 μ	±10, ±20	3.5	200	0.5±0.05	
MSAST105SB5333[FNA01]	TMK105 BJ333[V-F]	25	B	X5R ^{*1}	0.033 μ	±10, ±20	3.5	150	0.5±0.05	
MSAST105SB5473[FNA01]	TMK105 BJ473[V-F]	25	B	X5R ^{*1}	0.047 μ	±10, ±20	3.5	150	0.5±0.05	
MSAST105SB5104[FNA01]	TMK105 BJ104[V-F]	25	B	X5R	0.1 μ	±10, ±20	5	150	0.5±0.05	
MSAST105SB5224[FNA01]	TMK105 BJ224[V-F]	25	X5R	0.22 μ	±10, ±20	10	200		0.5±0.05	
MSAST105AB5474[FNA01]	TMK105ABJ474[V-F]	25	X5R	0.47 μ	±10, ±20	10	200		0.5±0.10	
MSAST105SB5105[FNA01]	TMK105 BJ105[V-F]	25	X5R	1 μ	±10, ±20	10	150		0.5±0.05	
MSAST105CB5225[FNA01]	TMK105CBJ225[V-F]	25	X5R	2.2 μ	±10, ±20	10	150		0.5+0.20/-0	
MSASE105SB5224[FNA01]	EMK105 BJ224[V-F]	16	B	X5R	0.22 μ	±10, ±20	5	150	0.5±0.05	
MSASE105AB5474[FNA01]	EMK105ABJ474[V-F]	16	X5R	0.47 μ	±10, ±20	10	200		0.5±0.10	
MSASE105SB5105[FNA01]	EMK105 BJ105[V-F]	16	X5R	1 μ	±10, ±20	10	150		0.5±0.05	
MSASE105AB5225[FNA01]	EMK105ABJ225[V-F]	16	X5R	2.2 μ	±10, ±20	10	150		0.5±0.10	
MSASL105SB5225[FNA01]	LMK105 BJ225[V-F]	10	X5R	2.2 μ	±10, ±20	10	150		0.5±0.05	
MSASL105BB5475MFNB33	LMK105BBJ475MVLVLF	10	X5R	4.7 μ	±20	10	150		0.5+0.15/-0.05	
MSASJ105SB5225[FNA01]	JMK105 BJ225[V-F]	6.3	X5R	2.2 μ	±10, ±20	10	150		0.5±0.05	
MSASJ105BB5475MFNA01	JMK105BBJ475MPV-F	6.3	X5R	4.7 μ	±20	10	150		0.5+0.15/-0.05	
MSASA105EB5226MFNA01	AMK105EBJ226MPV-F	4	X5R	22 μ	±20	20	150		0.5+0.30/-0	

【Temperature Characteristic B5(BJ) : B (−25~+85°C)/X5R (−55~+85°C)】 0.3mm thickness

New part number	Old part number (for reference)	Rated voltage [V]	Temperature characteristics	Capacitance [F]	Capacitance tolerance [%]	tan δ [%]	HTLT		Thickness ^{*3} [mm]	Note
							Rated voltage x %			
MSASU1L3YB5104[FNA01]	UMK105 BJ104[P-F]	50	X5R	0.1 μ	±10, ±20	10	150		0.3±0.03	
MSAST1L3YB5103[FNA01]	TMK105 BJ103[P-F]	25	B	X5R	0.01 μ	±10, ±20	5	150	0.3±0.03	
MSAST1L3YB5104[FNA01]	TMK105 BJ104[P-F]	25	X5R	0.1 μ	±10, ±20	10	150		0.3±0.03	
MSAST1L3YB5224[FNA01]	TMK105 BJ224[P-F]	25	X5R	0.22 μ	±10, ±20	10	150		0.3±0.03	
MSAST1L3YB5474[FNA01]	TMK105 BJ474[P-F]	25	X5R	0.47 μ	±10, ±20	10	150		0.3±0.03	
MSASE1L3YB5474[FNA01]	EMK105 BJ474[P-F]	16	X5R	0.47 μ	±10, ±20	10	150		0.3±0.03	
MSASL1L3YB5105[FNB33]	LMK105 BJ105[PLF]	10	X5R	1 μ	±10, ±20	10	150		0.3±0.03	
MSASJ1L3YB5105[FNA01]	JMK105 BJ105[P-F]	6.3	X5R	1 μ	±10, ±20	10	150		0.3±0.03	
MSASA1L3YB5225MFNA01	AMK105 BJ225MP-F	4	X5R	2.2 μ	±20	10	150		0.3±0.03	

PARTS NUMBER

【Temperature Characteristic B5 (BJ) : X5R(-55~+85°C)】 0.2mm thickness

New part number	Old part number (for reference)	Rated voltage [V]	Temperature characteristics	Capacitance [F]	Capacitance tolerance [%]	tan δ [%]	HTLT	Thickness ^{*3} [mm]	Note
							Rated voltage x %		
MSASL1L2XB5104□FNA01	LMK105 BJ104□C-F	10	X5R	0.1 μ	±10, ±20	10	150	0.2±0.02	
MSASJ1L2XB5224□FNA01	JMK105 BJ224□C-F	6.3	X5R	0.22 μ	±10, ±20	10	150	0.2±0.02	
MSASJ1L2XB5474□FNA01	JMK105 BJ474□C-F	6.3	X5R	0.47 μ	±10, ±20	10	150	0.2±0.02	
MSASJ1L2XB5105MFNA01	JMK105 BJ105MC-F	6.3	X5R	1 μ	±20	10	150	0.2±0.02	

【Temperature Characteristic B5 (BJ) : X5R(-55~+85°C)】 0.18mm thickness

New part number	Old part number (for reference)	Rated voltage [V]	Temperature characteristics	Capacitance [F]	Capacitance tolerance [%]	tan δ [%]	HTLT	Thickness ^{*3} [mm]	Note
							Rated voltage x %		
MSASL1LEXB5104□RNA01	LMK105 BJ104□E-R	10	X5R	0.1 μ	±10, ±20	10	150	0.18±0.02	
MSASJ1LEXB5224□RNA01	JMK105 BJ224□E-R	6.3	X5R	0.22 μ	±10, ±20	10	150	0.18±0.02	
MSASJ1LEXB5474□RNA01	JMK105 BJ474□E-R	6.3	X5R	0.47 μ	±10, ±20	10	150	0.18±0.02	
MSASA1LEXB5105MRNA01	AMK105 BJ105ME-R	4	X5R	1 μ	±20	10	150	0.18±0.02	

【Temperature Characteristic B5 (BJ) : X5R(-55~+85°C)】 0.13mm thickness

New part number	Old part number (for reference)	Rated voltage [V]	Temperature characteristics	Capacitance [F]	Capacitance tolerance [%]	tan δ [%]	HTLT	Thickness ^{*3} [mm]	Note
							Rated voltage x %		
MSASL1LHXB5104MRNA01	LMK105 BJ104MH-R	10	X5R	0.1 μ	±20	10	150	0.13±0.02	
MSASJ1LHXB5224MRNA01	JMK105 BJ224MH-R	6.3	X5R	0.22 μ	±20	10	150	0.13±0.02	
MSASA1LHXB5474MRNA01	AMK105 BJ474MH-R	4	X5R	0.47 μ	±20	10	150	0.13±0.02	

【Temperature Characteristic C6 : X6S(-55~+105°C)】 0.5mm thickness

New part number	Old part number (for reference)	Rated voltage [V]	Temperature characteristics	Capacitance [F]	Capacitance tolerance [%]	tan δ [%]	HTLT	Thickness ^{*3} [mm]	Note
							Rated voltage x %		
MSASG105CC6105□FNA01	GMK105CC6105□V-F	35	X6S	1 μ	±10, ±20	10	150	0.5+0.20/-0	
MSAST105AC6105□FNA01	TMK105AC6105□V-F	25	X6S	1 μ	±10, ±20	10	150	0.5±0.10	
MSAST105CC6105MFNA01	TMK105CC6105MV-F	25	X6S	1 μ	±20	10	150	0.5+0.20/-0	
MSASE105SC6105□FNA01	EMK105 SC6105□V-F	16	X6S	1 μ	±10, ±20	10	150	0.5±0.05	
MSASE105CC6225□FNA01	EMK105CC6225□V-F	16	X6S	2.2 μ	±10, ±20	10	150	0.5+0.20/-0	
MSASL105SC6105□FNA01	LMK105 C6105□V-F	10	X6S	1 μ	±10, ±20	10	200	0.5±0.05	
MSASL105AC6225□FNA01	LMK105AC6225□V-F	10	X6S	2.2 μ	±10, ±20	10	150	0.5±0.10	
MSASJ105SC6225□FNA01	JMK105 C6225□V-F	6.3	X6S	2.2 μ	±10, ±20	10	150	0.5±0.05	
MSASJ105BC6475MFNA01	JMK105BC6475MV-F	6.3	X6S	4.7 μ	±20	10	150	0.5+0.15/-0.05	
MSASA105BC6475MFNA01	AMK105BC6475MV-F	4	X6S	4.7 μ	±20	10	200	0.5+0.15/-0.05	
MSASP105EC6226MFNA01	PMK105EC6226MV-F	2.5	X6S	22 μ	±20	20	150	0.5+0.30/-0	

【Temperature Characteristic B7 : X7R(-55~+125°C)】 0.5mm thickness

New part number	Old part number (for reference)	Rated voltage [V]	Temperature characteristics	Capacitance [F]	Capacitance tolerance [%]	tan δ [%]	HTLT	Thickness ^{*3} [mm]	Note
							Rated voltage x %		
MSASU105SB7152□FNA01	UMK105 B7152□V-F	50	X7R	1500 p	±10, ±20	2.5	200	0.5±0.05	
MSASU105SB7222□FNA01	UMK105 B7222□V-F	50	X7R	2200 p	±10, ±20	2.5	200	0.5±0.05	
MSASU105SB7332□FNA01	UMK105 B7332□V-F	50	X7R	3300 p	±10, ±20	2.5	200	0.5±0.05	
MSASU105SB7472□FNA01	UMK105 B7472□V-F	50	X7R	4700 p	±10, ±20	2.5	150	0.5±0.05	
MSASU105SB7682□FNA01	UMK105 B7682□V-F	50	X7R	6800 p	±10, ±20	2.5	150	0.5±0.05	
MSASU105SB7103□FNA01	UMK105 B7103□V-F	50	X7R	0.01 μ	±10, ±20	3.5	150	0.5±0.05	
MSASU105SB7223□FNB25	UMK105 B7223□V-FR	50	X7R	0.022 μ	±10, ±20	10	200	0.5±0.05	
MSASU105SB7473□FNB25	UMK105 B7473□V-FR	50	X7R	0.047 μ	±10, ±20	10	200	0.5±0.05	
MSASU105SB7104□FNB25	UMK105 B7104□V-FR	50	X7R	0.1 μ	±10, ±20	10	150	0.5±0.05	
MSAST105SB7223□FNA01	TMK105 B7223□V-F	25	X7R	0.022 μ	±10, ±20	3.5	150	0.5±0.05	
MSAST105SB7473□FNA01	TMK105 B7473□V-F	25	X7R	0.047 μ	±10, ±20	3.5	150	0.5±0.05	
MSAST105SB7104□FNB25	TMK105 B7104□V-FR	25	X7R	0.1 μ	±10, ±20	10	200	0.5±0.05	
MSAST105SB7224□FNB25	TMK105 B7224□V-FR	25	X7R	0.22 μ	±10, ±20	10	150	0.5±0.05	
MSASE105SB7223□FNA01	EMK105 B7223□V-F	16	X7R	0.022 μ	±10, ±20	3.5	200	0.5±0.05	
MSASE105SB7473□FNA01	EMK105 B7473□V-F	16	X7R	0.047 μ	±10, ±20	3.5	200	0.5±0.05	
MSASE105SB7104□FNA01	EMK105 B7104□V-F	16	X7R	0.1 μ	±10, ±20	5	150	0.5±0.05	
MSASE105SB7224□FNB25	EMK105 B7224□V-FR	16	X7R	0.22 μ	±10, ±20	10	150	0.5±0.05	
MSASL105SB7224□FNB25	LMK105 B7224□V-FR	10	X7R	0.22 μ	±10, ±20	10	150	0.5±0.05	
MSASL105SB7474□FNA01	LMK105 B7474□V-F	10	X7R	0.47 μ	±10, ±20	10	150	0.5±0.05	
MSASJ105SB7224□FNA01	JMK105 B7224□V-F	6.3	X7R	0.22 μ	±10, ±20	5	150	0.5±0.05	
MSASJ105SB7474□FNA01	JMK105 B7474□V-F	6.3	X7R	0.47 μ	±10, ±20	10	150	0.5±0.05	

PARTS NUMBER

1608TYPE

【Temperature Characteristic B5 (BJ) : X5R(-55~+85°C)】 0.8mm thickness

New part number	Old part number (for reference)	Rated voltage [V]	Temperature characteristics	Capacitance [F]	Capacitance tolerance [%]	tan δ [%]	HTLT	Thickness*3 [mm]	Note
							Rated voltage x %		
MSASU168AB5474□TNA01	UMK107ABJ474□A-T	50	X5R	0.47 μ	±10, ±20	10	150	0.8+0.15/-0.05	
MSASU168SB5105□TNA01	UMK107 BJ105□A-T	50	X5R	1 μ	±10, ±20	10	150	0.8±0.10	
MSASU168BB5225□TNA01	UMK107BBJ225□A-T	50	X5R	2.2 μ	±10, ±20	10	150	0.8+0.20/-0	
MSASG168BB5475□TNA01	GMK107BBJ475□A-T	35	X5R	4.7 μ	±10, ±20	10	150	0.8+0.20/-0	
MSAST168AB5225□TNA01	TMK107ABJ225□A-T	25	X5R	2.2 μ	±10, ±20	10	150	0.8+0.15/-0.05	
MSAST168BB5475□TNA01	TMK107BBJ475□A-T	25	X5R	4.7 μ	±10, ±20	10	150	0.8+0.20/-0	
MSAST168BB5106MTNA01	TMK107BBJ106MA-T	25	X5R	10 μ	±20	10	150	0.8+0.20/-0	
MSASE168AB5475□TNA01	EMK107ABJ475□A-T	16	X5R	4.7 μ	±10, ±20	10	150	0.8+0.15/-0.05	
MSASE168BB5106MTNA01	EMK107BBJ106MA-T	16	X5R	10 μ	±20	10	150	0.8+0.20/-0	
MSASL168BB5106□TNA01	LMK107BBJ106□A-T	16	X5R	10 μ	±20	10	150	0.8+0.20/-0	
MSASL168BB5106□TNA01	LMK107BBJ106□ALT	10	X5R	10 μ	±10, ±20	10	150	0.8+0.20/-0	
MSASL168BB5226MTNA01	LMK107BBJ226MA-T	10	X5R	22 μ	±20	10	150	0.8+0.20/-0	
MSASJ168AB5106□TNA01	JMK107ABJ106□A-T	6.3	X5R	10 μ	±10, ±20	10	150	0.8+0.15/-0.05	
MSASJ168BB5226MTNA01	JMK107BBJ226MA-T	6.3	X5R	22 μ	±20	10	150	0.8+0.20/-0	
MSASJ168BB5476MRCOA01	JMK107BBJ476MA-RE	6.3	X5R	47 μ	±20	15	150	0.8+0.20/-0	
MSASA168BB5476MRCOA01	AMK107BBJ476MA-RE	4	X5R	47 μ	±20	20	150	0.8+0.20/-0	

【Temperature Characteristic B5 (BJ) : X5R(-55~+85°C)】 0.45mm thickness

New part number	Old part number (for reference)	Rated voltage [V]	Temperature characteristics	Capacitance [F]	Capacitance tolerance [%]	tan δ [%]	HTLT	Thickness*3 [mm]	Note
							Rated voltage x %		
MSAST16KTB5105□TNA01	TMK107 BJ105□K-T	25	X5R	1 μ	±10, ±20	10	150	0.45±0.05	
MSASE16KTB5105□TNA01	EMK107 BJ105□K-T	16	X5R	1 μ	±10, ±20	10	150	0.45±0.05	
MSASE16KJB5225□TNA01	EMK107BBJ225□K-T	16	X5R	2.2 μ	±10, ±20	10	150	0.45±0.05	
MSASL16KTB5105□TNA01	LMK107 BJ105□K-T	10	X5R	1 μ	±10, ±20	10	150	0.45±0.05	
MSASL16KJB5225□TNA01	LMK107 BJ225□K-T	10	X5R	2.2 μ	±10, ±20	10	150	0.45±0.05	
MSASL16KJB5475MTNB33	LMK107BBJ475MKLT	10	X5R	4.7 μ	±20	10	150	0.45±0.05	
MSASJ16KTB5105□TNA01	JMK107 BJ105□K-T	6.3	X5R	1 μ	±10, ±20	10	150	0.45±0.05	
MSASJ16KJB5225□TNA01	JMK107 BJ225□K-T	6.3	X5R	2.2 μ	±10, ±20	10	150	0.45±0.05	
MSASJ16KTB5475MTNA01	JMK107 BJ475MK-T	6.3	X5R	4.7 μ	±20	10	150	0.45±0.05	
MSASJ16KJB5106MTNC12	JMK107BBJ106MK-TT	6.3	X5R	10 μ	±20	10	150	0.45±0.05	

【Temperature Characteristic C6 : X6S(-55~+105°C)】 0.8mm thickness

New part number	Old part number (for reference)	Rated voltage [V]	Temperature characteristics	Capacitance [F]	Capacitance tolerance [%]	tan δ [%]	HTLT	Thickness*3 [mm]	Note
							Rated voltage x %		
MSAST168BC6225□TNA01	TMK107BC6225□A-T	25	X6S	2.2 μ	±10, ±20	10	150	0.8+0.20/-0	
MSASE168SC6105□TNA01	EMK107 C6105□A-T	16	X6S	1 μ	±10, ±20	5	150	0.8±0.10	
MSASE168BC6225□TNA01	EMK107BC6225□A-T	16	X6S	2.2 μ	±10, ±20	10	150	0.8+0.20/-0	
MSASE168BC6475□TNA01	EMK107BC6475□A-T	16	X6S	4.7 μ	±10, ±20	10	150	0.8+0.20/-0	
MSASL168SC6105□TNA01	LMK107 C6105□A-T	10	X6S	1 μ	±10, ±20	5	150	0.8±0.10	
MSASL168AC6475□TNA01	LMK107AC6475□A-T	10	X6S	4.7 μ	±10, ±20	10	150	0.8+0.15/-0.05	
MSASL168BC6106MTNA01	LMK107BC6106MA-T	10	X6S	10 μ	±20	10	150	0.8+0.20/-0	
MSASJ168SC6475□TNA01	JMK107 C6475□A-T	6.3	X6S	4.7 μ	±10, ±20	10	150	0.8±0.10	
MSASJ168BC6106MTNA01	JMK107BC6106MA-T	6.3	X6S	10 μ	±20	10	150	0.8+0.20/-0	
MSASJ168BC6226MTNA01	JMK107BC6226MA-T	6.3	X6S	22 μ	±20	10	150	0.8+0.20/-0	
MSASA168BC6226MTNA01	AMK107BC6226MA-T	4	X6S	22 μ	±20	10	150	0.8+0.20/-0	
MSASA168BC6476MRCOA01	AMK107BC6476MA-RE	4	X6S	47 μ	±20	20	150	0.8+0.20/-0	

【Temperature Characteristic B7 : X7R(-55~+125°C)】 0.8mm thickness

New part number	Old part number (for reference)	Rated voltage [V]	Temperature characteristics	Capacitance [F]	Capacitance tolerance [%]	tan δ [%]	HTLT	Thickness*3 [mm]	Note
							Rated voltage x %		
MSASU168SB7224□TNA01	UMK107 B7224□A-TR	50	X7R	0.22 μ	±10, ±20	10	150	0.8±0.10	
MSASU168SB7474□TNA01	UMK107 B7474□A-TR	50	X7R	0.47 μ	±10, ±20	10	150	0.8±0.10	
MSASU168AB7105□TNA01	UMK107AB7105□A-T	50	X7R	1 μ	±10, ±20	10	150	0.8+0.15/-0.05	
MSAST168SB7474□TNA01	TMK107 B7474□A-TR	25	X7R	0.47 μ	±10, ±20	10	150	0.8±0.10	
MSAST168SB7105□TNA01	TMK107 B7105□A-T	25	X7R	1 μ	±10, ±20	10	150	0.8±0.10	
MSASE168SB7474□TNA01	EMK107 B7474□A-T	16	X7R	0.47 μ	±10, ±20	3.5	150	0.8±0.10	
MSASE168SB7105□TNA01	EMK107 B7105□A-T	16	X7R	1 μ	±10, ±20	5	150	0.8±0.10	
MSASE168BB7225□TNA01	EMK107BB7225□A-T	16	X7R	2.2 μ	±10, ±20	10	150	0.8+0.20/-0	
MSASL168SB7225□TNA01	LMK107 B7225□A-TR	10	X7R	2.2 μ	±10, ±20	10	150	0.8±0.10	
MSASJ168SB7225□TNA01	JMK107 B7225□A-TR	6.3	X7R	2.2 μ	±10, ±20	10	200	0.8±0.10	
MSASJ168BB7475□TNA01	JMK107BB7475□A-T	6.3	X7R	4.7 μ	±10, ±20	10	150	0.8+0.20/-0	

PARTS NUMBER

2012TYPE

【Temperature Characteristic B5(BJ) : X5R(-55~+85°C)】 1.25mm thickness

New part number	Old part number (for reference)	Rated voltage [V]	Temperature characteristics	Capacitance [F]	Capacitance tolerance [%]	tan δ [%]	HTLT	Thickness*3 [mm]	Note
							Rated voltage x %		
MSASU21GBB5475□TNA01	UMK212BBJ475□G-T	50	X5R	4.7 μ	±10, ±20	10	150	1.25±0.20/-0	
MSASG21GBB5106□TNA01	GMK212BBJ106□G-T	35	X5R	10 μ	±10, ±20	10	150	1.25±0.20/-0	
MSAST21GAB5475□TNA01	TMK212ABJ475□G-T	25	X5R	4.7 μ	±10, ±20	10	150	1.25±0.15/-0.05	
MSAST21GBB5106□TNA01	TMK212BBJ106□G-T	25	X5R	10 μ	±10, ±20	10	150	1.25±0.20/-0	
MSAST21GBB5226MTNC12	TMK212BBJ226MG-TT	25	X5R	22 μ	±20	10	150	1.25±0.20/-0	
MSASE21GAB5106□TNA01	EMK212ABJ106□G-T	16	X5R	10 μ	±10, ±20	10	150	1.25±0.15/-0.05	
MSASE21GBB5226MTNA01	EMK212BBJ226MG-T	16	X5R	22 μ	±20	10	150	1.25±0.20/-0	
MSASL21GBB5226MTNA01	LMK212BBJ226MG-T	10	X5R	22 μ	±20	10	150	1.25±0.20/-0	
MSASL21GBB5476MTNA01	LMK212BBJ476MG-T	10	X5R	47 μ	±20	10	150	1.25±0.20/-0	
MSASJ21GAB5226□TNA01	JMK212ABJ226□G-T	6.3	X5R	22 μ	±10, ±20	10	150	1.25±0.15/-0.05	
MSASJ21GBB5476MTNA01	JMK212BBJ476MG-T	6.3	X5R	47 μ	±20	10	150	1.25±0.20/-0	
MSASJ21GBB5107MTCA01	JMK212BBJ107MG-TE	6.3	X5R	100 μ	±20	20	150	1.25±0.20/-0	
MSASA21GBB5107MTCA01	AMK212BBJ107MG-TE	4	X5R	100 μ	±20	20	150	1.25±0.20/-0	
MSASP21GBB5107MTNA01	PMK212BBJ107MG-T	2.5	X5R	100 μ	±20	10	150	1.25±0.20/-0	

【Temperature Characteristic B5(BJ) : B(-25~+85°C)/X5R(-55~+85°C)】 0.85mm thickness

New part number	Old part number (for reference)	Rated voltage [V]	Temperature characteristics	Capacitance [F]	Capacitance tolerance [%]	tan δ [%]	HTLT	Thickness*3 [mm]	Note
							Rated voltage x %		
MSASU219JB5105□TNA01	UMK212ABJ105□D-T	50	X5R	1 μ	±10, ±20	10	150	0.85±0.10	
MSASU219LB5225□TNA01	UMK212BBJ225□D-T	50	X5R	2.2 μ	±10, ±20	10	150	0.85±0.10	
MSASG219LB5475□TNA01	GMK212BBJ475□D-T	35	X5R	4.7 μ	±10, ±20	10	150	0.85±0.10	
MSAST219SB5474□TNA01	TMK212 B J474□D-T	25	B X5R	0.47 μ	±10, ±20	3.5	200	0.85±0.10	
MSAST219SB5105□TNA01	TMK212 B J105□D-T	25	B X5R	1 μ	±10, ±20	5	200	0.85±0.10	
MSAST219JB5225□TNA01	TMK212ABJ225□D-T	25	X5R	2.2 μ	±10, ±20	5	150	0.85±0.10	
MSAST219LB5475□TNA01	TMK212BBJ475□D-T	25	X5R	4.7 μ	±10, ±20	10	150	0.85±0.10	
MSAST219LB5106□TNA01	TMK212BBJ106□D-T	25	X5R	10 μ	±10, ±20	10	150	0.85±0.10	
MSASE219SB5105□TNA01	EMK212 B J105□D-T	16	B X5R ⁺	1 μ	±10, ±20	5	200	0.85±0.10	
MSASE219JB5225□TNA01	EMK212ABJ225□D-T	16	X5R ⁺	2.2 μ	±10, ±20	5	200	0.85±0.10	
MSASE219SB5475□TNA01	EMK212 B J475□D-T	16	X5R	4.7 μ	±10, ±20	10	150	0.85±0.10	
MSASE219JB5106□TNA01	EMK212ABJ106□D-T	16	X5R	10 μ	±10, ±20	10	150	0.85±0.10	
MSASL219SB5105□TNA01	LMK212 B J105□D-T	10	B X5R ⁺	1 μ	±10, ±20	3.5	200	0.85±0.10	
MSASL219SB5225□TNA01	LMK212 B J225□D-T	10	X5R ⁺	2.2 μ	±10, ±20	5	200	0.85±0.10	
MSASL219JB5106□TNA01	LMK212ABJ106□D-T	10	X5R	10 μ	±10, ±20	10	150	0.85±0.10	
MSASL219LB5226MTNA01	LMK212BBJ226MD-T	10	X5R	22 μ	±20	10	150	0.85±0.10	
MSASJ219JB5106□TNA01	JMK212ABJ106□D-T	6.3	X5R	10 μ	±10, ±20	10	200	0.85±0.10	
MSASJ219JB5226MTNA01	JMK212ABJ226MD-T	6.3	X5R	22 μ	±20	10	150	0.85±0.10	
MSASA219LB5476MTNA01	AMK212BBJ476MD-T	4	X5R	47 μ	±20	10	150	0.85±0.10	

【Temperature Characteristic X6S(-55~+105°C)】 1.25mm thickness

New part number	Old part number (for reference)	Rated voltage [V]	Temperature characteristics	Capacitance [F]	Capacitance tolerance [%]	tan δ [%]	HTLT	Thickness*3 [mm]	Note
							Rated voltage x %		
MSAST21GBC6106□TNA01	TMK212BC6106□G-T	25	X6S	10 μ	±10, ±20	10	150	1.25±0.20/-0	
MSASE21GBC6226MTNC12	EMK212BC6226MG-TT	16	X6S	22 μ	±20	10	150	1.25±0.20/-0	
MSASL21GBC6226MTNA01	LMK212BC6226MG-T	10	X6S	22 μ	±20	10	150	1.25±0.20/-0	
MSASJ21GBC6226MTNA01	JMK212BC6226MG-T	6.3	X6S	22 μ	±20	10	150	1.25±0.20/-0	
MSASJ21GBC6476MTNA01	JMK212BC6476MG-T	6.3	X6S	47 μ	±20	10	150	1.25±0.20/-0	
MSASA21GBC6476MTNA01	AMK212BC6476MG-T	4	X6S	47 μ	±20	10	150	1.25±0.20/-0	
MSASA21GBC6107MTCA01	AMK212BC6107MG-TE	4	X6S	100 μ	±20	20	150	1.25±0.20/-0	

【Temperature Characteristic C6 : X6S(-55~+105°C)】 0.85mm thickness

New part number	Old part number (for reference)	Rated voltage [V]	Temperature characteristics	Capacitance [F]	Capacitance tolerance [%]	tan δ [%]	HTLT	Thickness*3 [mm]	Note
							Rated voltage x %		
MSASL219JC6106□TNA01	LMK212AC6106□D-T	10	X6S	10 μ	±10, ±20	10	150	0.85±0.10	
MSASA219LC6226MTNA01	AMK212BC6226MD-T	4	X6S	22 μ	±20	10	150	0.85±0.10	

【Temperature Characteristic B7 : X7R(-55~+125°C)】 1.25mm thickness

New part number	Old part number (for reference)	Rated voltage [V]	Temperature characteristics	Capacitance [F]	Capacitance tolerance [%]	tan δ [%]	HTLT	Thickness*3 [mm]	Note
							Rated voltage x %		
MSASU21GSB7224□TNA01	UMK212 B7224□G-T	50	X7R	0.22 μ	±10, ±20	3.5	150	1.25±0.10	
MSASU21GSB7474□TNA01	UMK212 B7474□G-T	50	X7R	0.47 μ	±10, ±20	3.5	150	1.25±0.10	
MSASU21GSB7105□TNA01	UMK212 B7105□G-T	50	X7R	1 μ	±10, ±20	10	150	1.25±0.10	
MSASU21GGB7225□TNA01	UMK212BB7225□G-T	50	X7R	2.2 μ	±10, ±20	10	150	1.25±0.20/-0	
MSASG21GSB7105□TNA01	GMK212 B7105□G-T	35	X7R	1 μ	±10, ±20	10	150	1.25±0.10	
MSAST21GSB7225□TNB25	TMK212 B7225□G-TR	25	X7R	2.2 μ	±10, ±20	10	150	1.25±0.10	
MSAST21GAB7475□TNA01	TMK212AB7475□G-T	25	X7R	4.7 μ	±10, ±20	10	150	1.25±0.15/-0.05	
MSASE21GSB7475□TNA01	EMK212 B7475□G-T	16	X7R	4.7 μ	±10, ±20	10	150	1.25±0.10	
MSASE21GGB7106MTNA01	EMK212BB7106MG-T	16	X7R	10 μ	±20	10	150	1.25±0.20/-0	
MSASL21GAB7106□TNA01	LMK212AB7106□G-T	10	X7R	10 μ	±10, ±20	10	150	1.25±0.15/-0.05	
MSASJ21GAB7106□TNA01	JMK212AB7106□G-T	6.3	X7R	10 μ	±10, ±20	10	150	1.25±0.15/-0.05	

PARTS NUMBER

【Temperature Characteristic B7 : X7R (−55~+125°C)】 0.85mm thickness

New part number	Old part number (for reference)	Rated voltage [V]	Temperature characteristics		Capacitance [F]	Capacitance tolerance [%]	tan δ [%]	HTLT	Thickness ^{*3} [mm]	Note
								Rated voltage x %		
MSASU219JB7104□TNA01	UMK212AB7104□D-T	50		X7R	0.1 μ	±10, ±20	10	150	0.85±0.10	
MSASU219JB7224□TNA01	UMK212AB7224□D-T	50		X7R	0.22 μ	±10, ±20	10	150	0.85±0.10	
MSASU219JB7474□TNA01	UMK212AB7474□D-T	50		X7R	0.47 μ	±10, ±20	10	150	0.85±0.10	
MSASU219JB7105□TNA01	UMK212AB7105□D-T	50		X7R	1 μ	±10, ±20	10	150	0.85±0.10	
MSAST219JB7225□TNB25	TMK212AB7225□D-TR	25		X7R	2.2 μ	±10, ±20	10	150	0.85±0.10	
MSASE219SB7474□TNA01	EMK212 B7474□D-T	16		X7R	0.47 μ	±10, ±20	3.5	200	0.85±0.10	
MSASE219SB7105□TNA01	EMK212 B7105□D-T	16		X7R	1 μ	±10, ±20	5	200	0.85±0.10	
MSASE219JB7225□TNA01	EMK212AB7225□D-T	16		X7R	2.2 μ	±10, ±20	5	150	0.85±0.10	
MSASE219LB7475MTNA01	EMK212BB7475MD-T	16		X7R	4.7 μ	±20	10	150	0.85±0.10	
MSASL219SB7105□TNA01	LMK212 B7105□D-T	10		X7R	1 μ	±10, ±20	3.5	200	0.85±0.10	
MSASL219JB7225□TNA01	LMK212AB7225□D-T	10		X7R	2.2 μ	±10, ±20	5	200	0.85±0.10	
MSASL219JB7475□TNB25	LMK212AB7475□D-TR	10		X7R	4.7 μ	±10, ±20	10	150	0.85±0.10	

● 3216TYPE

【Temperature Characteristic B5(BJ) : X5R (−55~+85°C)】 1.6mm thickness

New part number	Old part number (for reference)	Rated voltage [V]	Temperature characteristics		Capacitance [F]	Capacitance tolerance [%]	tan δ [%]	HTLT	Thickness ^{*3} [mm]	Note
								Rated voltage x %		
MSASU31LSB5475□TNA01	UMK316 BJ475□L-T	50		X5R	4.7 μ	±10, ±20	10	150	1.6±0.20	
MSASU31LBB5106□TNA01	UMK316BBJ106□L-T	50		X5R	10 μ	±10, ±20	10	150	1.6±0.30	
MSAST31LBB5226MTNA01	TMK316BBJ226ML-T	25		X5R	22 μ	±20	10	150	1.6±0.30	
MSASE31LBB5476MTNA01	EMK316BBJ476ML-T	16		X5R	47 μ	±20	10	150	1.6±0.30	
MSASL31LAB5476MTNA01	LMK316ABJ476ML-T	10		X5R	47 μ	±20	10	150	1.6±0.20	
MSASJ31LAB5107MTNA01	JMK316ABJ107ML-T	6.3		X5R	100 μ	±20	10	150	1.6±0.20	
MSASJ31LBB5227MTCA01	JMK316BBJ227ML-TE	6.3		X5R	220 μ	±20	20	150	1.6±0.30	
MSASA31LAB5107MTNA01	AMK316ABJ107ML-T	4		X5R	100 μ	±20	10	150	1.6±0.20	
MSASA31LBB5157MTNA01	AMK316BBJ157ML-T	4		X5R	150 μ	±20	10	150	1.6±0.30	
MSASA31LBB5227MTCA01	AMK316BBJ227ML-TE	4		X5R	220 μ	±20	10	150	1.6±0.30	
MSASP31LBB5227MTNA01	PMK316BBJ227ML-T	2.5		X5R	220 μ	±20	10	150	1.6±0.30	

【Temperature Characteristic B5(BJ) : B (−25~+85°C)/X5R (−55~+85°C)】 0.85mm thickness

New part number	Old part number (for reference)	Rated voltage [V]	Temperature characteristics		Capacitance [F]	Capacitance tolerance [%]	tan δ [%]	HTLT	Thickness ^{*3} [mm]	Note
								Rated voltage x %		
MSASU319HB5105□TNA01	UMK316 BJ105□D-T	50	B	X5R	1 μ	±10, ±20	3.5	150	0.85±0.10	
MSASU319HB5225□TNA01	UMK316 BJ225□D-T	50	B	X5R	2.2 μ	±10, ±20	3.5	150	0.85±0.10	
MSASU319LB5475□TNA01	UMK316ABJ475□D-T	50		X5R	4.7 μ	±10, ±20	10	150	0.85±0.10	
MSAST319HB5105□TNA01	TMK316 BJ105□D-T	25	B	X5R	1 μ	±10, ±20	3.5	200	0.85±0.10	
MSAST319HB5225□TNA01	TMK316 BJ225□D-T	25	B	X5R	2.2 μ	±10, ±20	3.5	150	0.85±0.10	
MSAST319HB5475□TNA01	TMK316 BJ475□D-T	25		X5R	4.7 μ	±10, ±20	5	150	0.85±0.10	
MSAST319LB5106□TNA01	TMK316ABJ106□D-T	25		X5R	10 μ	±10, ±20	10	150	0.85±0.10	
MSASE319HB5225□TNA01	EMK316 BJ225□D-T	16	B	X5R	2.2 μ	±10, ±20	3.5	200	0.85±0.10	
MSASE319HB5475□TNA01	EMK316 BJ475□D-T	16	B	X5R	4.7 μ	±10, ±20	5	200	0.85±0.10	
MSASE319HB5106□TNA01	EMK316 BJ106□D-T	16		X5R	10 μ	±10, ±20	10	150	0.85±0.10	
MSASE319LB5226MTNA01	EMK316ABJ226MD-T	16		X5R	22 μ	±20	10	150	0.85±0.10	
MSASL319HB5475□TNA01	LMK316 BJ475□D-T	10	B	X5R	4.7 μ	±10, ±20	5	200	0.85±0.10	
MSASL319HB5106□TNA01	LMK316 BJ106□D-T	10		X5R	10 μ	±10, ±20	10	200	0.85±0.10	
MSASL319LB5226MTNA01	LMK316ABJ226MD-T	10		X5R	22 μ	±20	10	150	0.85±0.10	
MSASJ319HB5106□TNA01	JMK316 BJ106□D-T	6.3		X5R	10 μ	±10, ±20	10	200	0.85±0.10	
MSASJ319LB5226MTNA01	JMK316ABJ226MD-T	6.3		X5R	22 μ	±20	10	150	0.85±0.10	
MSASJ319LB5476MTNA01	JMK316ABJ476MD-T	6.3		X5R	47 μ	±20	10	150	0.85±0.10	

【Temperature Characteristic C6 : X6S (−55~+105°C)】 1.6mm thickness

New part number	Old part number (for reference)	Rated voltage [V]	Temperature characteristics		Capacitance [F]	Capacitance tolerance [%]	tan δ [%]	HTLT	Thickness ^{*3} [mm]	Note
								Rated voltage x %		
MSAST31LBC6226MTNA01	TMK316BC6226ML-T	25		X6S	22 μ	±20	10	150	1.6±0.30	
MSASE31LBC6226MTNA01	EMK316BC6226ML-T	16		X6S	22 μ	±20	10	150	1.6±0.30	
MSASL31LBC6476MTNA01	LMK316BC6476ML-T	10		X6S	47 μ	±20	10	150	1.6±0.30	
MSASJ31LAC6476MTNA01	JMK316AC6476ML-T	6.3		X6S	47 μ	±20	10	150	1.6±0.20	
MSASA31LAC6476MTNA01	AMK316AC6476ML-T	4		X6S	47 μ	±20	10	200	1.6±0.20	
MSASA31LAC6107MTNA01	AMK316AC6107ML-T	4		X6S	100 μ	±20	10	150	1.6±0.20	
MSASA31LBC6227MTCA01	AMK316BC6227ML-TE	4		X6S	220 μ	±20	20	150	1.6±0.30	

【Temperature Characteristic C7 : X7S (−55~+125°C)】 1.6mm thickness

New part number	Old part number (for reference)	Rated voltage [V]	Temperature characteristics		Capacitance [F]	Capacitance tolerance [%]	tan δ [%]	HTLT	Thickness ^{*3} [mm]	Note
								Rated voltage x %		
MSASJ31LAC7476MTNA01	JMK316AC7476ML-T	6.3		X7S	47 μ	±20	10	150	1.6±0.20	
MSASA31LAC7476MTNA01	AMK316AC7476ML-T	4		X7S	47 μ	±20	10	150	1.6±0.20	

PARTS NUMBER

【Temperature Characteristic B7 : X7R (−55~+125°C)】 1.6mm thickness

New part number	Old part number (for reference)	Rated voltage [V]	Temperature characteristics	Capacitance [F]	Capacitance tolerance [%]	tan δ [%]	HTLT	Thickness ³ [mm]	Note
							Rated voltage x %		
MSASU31LSB7225□TNA01	UMK316 B7225□L-T	50	X7R	2.2 μ	±10, ±20	10	150	1.6±0.20	
MSASU31LAB7475□TNA01	UMK316AB7475□L-T	50	X7R	4.7 μ	±10, ±20	10	150	1.6±0.20	
MSASG31LAB7106□TNA01	GMK316AB7106□L-TR	35	X7R	10 μ	±10, ±20	10	150	1.6±0.20	
MSAST31LAB7475□TNA01	TMK316AB7475□L-T	25	X7R	4.7 μ	±10, ±20	10	200	1.6±0.20	
MSAST31LAB7106□TNA01	TMK316AB7106□L-T	25	X7R	10 μ	±10, ±20	10	150	1.6±0.20	
MSASE31LSB7475□TNA01	EMK316 B7475□L-T	16	X7R	4.7 μ	±10, ±20	5	200	1.6±0.20	
MSASE31LAB7106□TNA01	EMK316AB7106□L-T	16	X7R	10 μ	±10, ±20	10	200	1.6±0.20	
MSASE31LBB7226MTNA01	EMK316BB7226ML-T	16	X7R	22 μ	±20	10	150	1.6±0.30	
MSASL31LAB7106□TNA01	LMK316AB7106□L-T	10	X7R	10 μ	±10, ±20	10	200	1.6±0.20	
MSASL31LAB7226□TNA01	LMK316AB7226□L-TR	10	X7R	22 μ	±10, ±20	10	150	1.6±0.20	

【Temperature Characteristic B7 : X7R (−55~+125°C)】 0.85mm thickness

New part number	Old part number (for reference)	Rated voltage [V]	Temperature characteristics	Capacitance [F]	Capacitance tolerance [%]	tan δ [%]	HTLT	Thickness ³ [mm]	Note
							Rated voltage x %		
MSASU319HB7225□TNA01	UMK316 B7225□D-T	50	X7R	2.2 μ	±10, ±20	10	150	0.85±0.10	
MSAST319LB7475□TNA01	TMK316AB7475□D-T	25	X7R	4.7 μ	±10, ±20	10	150	0.85±0.10	
MSASL319LB7106MTNA01	LMK316AB7106MD-T	10	X7R	10 μ	±20	10	150	0.85±0.10	

3225TYPE

【Temperature Characteristic B5(BJ) : B (−25~+85°C)/X5R (−55~+85°C)】 2.5mm thickness

New part number	Old part number (for reference)	Rated voltage [V]	Temperature characteristics	Capacitance [F]	Capacitance tolerance [%]	tan δ [%]	HTLT	Thickness ³ [mm]	Note
							Rated voltage x %		
MSASU32MSB5106□PNA01	UMK325 BJ106□M-P	50	X5R	10 μ	±10, ±20	5	150	2.5±0.20	
MSASG32MSB5226MPNA01	GMK325 BJ226MM-P	35	X5R	22 μ	±20	5	150	2.5±0.20	
MSAST32MAB5476MPNDT1	TMK325ABJ476MM-P	25	X5R	4.7 μ	±20	10	150	2.5±0.30	
MSASE32MAB5107MPNA01	EMK325ABJ107MM-P	16	X5R	100 μ	±20	10	150	2.5±0.30	
MSASL32MAB5107MPNA01	LMK325ABJ107MM-P	10	X5R	100 μ	±20	10	150	2.5±0.30	
MSASJ32MAB5157MPNDT1	JMK325ABJ157MM-P	6.3	X5R	150 μ	±20	10	150	2.5±0.30	
MSASJ32MAB5227MPNDT1	JMK325ABJ227MM-P	6.3	X5R	220 μ	±20	10	150	2.5±0.30	
MSASJ32MAB5337MPNDT1	JMK325ABJ337MM-PE	6.3	X5R	330 μ	±20	10	150	2.5±0.30	
MSASA32MAB5157MPNDT1	AMK325ABJ157MM-P	4	X5R	150 μ	±20	10	150	2.5±0.30	
MSASA32MAB5227MPNDT1	AMK325ABJ227MM-P	4	X5R	220 μ	±20	10	150	2.5±0.30	
MSASA32MAB5337MPNDT1	AMK325ABJ337MM-P	4	X5R	330 μ	±20	10	150	2.5±0.30	

【Temperature Characteristic B5(BJ) : B (−25~+85°C)/X5R (−55~+85°C)】 1.9mm thickness

New part number	Old part number (for reference)	Rated voltage [V]	Temperature characteristics	Capacitance [F]	Capacitance tolerance [%]	tan δ [%]	HTLT	Thickness ³ [mm]	Note
							Rated voltage x %		
MSASU32NSB5475□TNA01	UMK325 BJ475□N-T	50	X5R	4.7 μ	±10, ±20	10	150	1.9±0.20	
MSASG32NSB5225□TNA01	GMK325 BJ225□N-T	35	B X5R	2.2 μ	±10, ±20	3.5	200	1.9±0.20	
MSASG32NSB5475□TNA01	GMK325 BJ475□N-T	35	X5R	4.7 μ	±10, ±20	10	150	1.9±0.20	
MSASG32NSB5106□TNA01	GMK325 BJ106□N-T	35	X5R	10 μ	±10, ±20	5	150	1.9±0.20	
MSAST32NSB5335MTNA01	TMK325 BJ335MN-T	25	B X5R ^{*1}	3.3 μ	±20	3.5	200	1.9±0.20	
MSAST32NSB5475□TNA01	TMK325 BJ475□N-T	25	B X5R ^{*1}	4.7 μ	±10, ±20	3.5	200	1.9±0.20	
MSAST32NSB5106□TNA01	TMK325 BJ106□N-T	25	X5R	10 μ	±10, ±20	5	200	1.9±0.20	
MSASE32NSB5475□TNA01	EMK325 BJ475□N-T	16	B X5R ^{*1}	4.7 μ	±10, ±20	3.5	200	1.9±0.20	
MSASE32NSB5106□TNA01	EMK325 BJ106□N-T	16	X5R	10 μ	±10, ±20	3.5	200	1.9±0.20	
MSASE32YBB5476MTNA01	EMK325 BJ476MY-T	16	X5R	4.7 μ	±20	10	150	1.9±0.1/-0.2	
MSASL32NSB5106□TNA01	LMK325 BJ106□N-T	10	X5R	10 μ	±10, ±20	3.5	200	1.9±0.20	
MSASL32YBB5226MTNA01	LMK325 BJ226MY-T	10	B X5R	22 μ	±20	5	150	1.9±0.1/-0.2	
MSASJ32YBB5226MTNA01	JMK325 BJ226MY-T	6.3	B X5R	22 μ	±20	5	200	1.9±0.1/-0.2	
MSASJ32NSB5476MTNA01	JMK325 BJ476MN-T	6.3	X5R	4.7 μ	±20	10	150	1.9±0.20	
MSASJ32YBB5107MTNA01	JMK325 BJ107MY-T	6.3	X5R	100 μ	±20	10	150	1.9±0.1/-0.2	

【Temperature Characteristic B5(BJ) : B (−25~+85°C)/X5R (−55~+85°C)】 0.85mm thickness

New part number	Old part number (for reference)	Rated voltage [V]	Temperature characteristics	Capacitance [F]	Capacitance tolerance [%]	tan δ [%]	HTLT	Thickness ³ [mm]	Note
							Rated voltage x %		
MSAST329JB5106□TNA01	TMK325 BJ106□D-T	25	X5R	10 μ	±10, ±20	5	150	0.85±0.10	
MSASE329JB5106□TNA01	EMK325 BJ106□D-T	16	X5R	10 μ	±10, ±20	5	150	0.85±0.10	
MSASE329JB5226MTNA01	EMK325 BJ226MD-T	16	X5R	22 μ	±20	10	150	0.85±0.10	
MSASL329JB5335□TNA01	LMK325 BJ335□D-T	10	B X5R	3.3 μ	±10, ±20	3.5	200	0.85±0.10	
MSASL329JB5475□TNA01	LMK325 BJ475□D-T	10	B X5R	4.7 μ	±10, ±20	5	200	0.85±0.10	
MSASL329JB5106□TNA01	LMK325 BJ106□D-T	10	X5R	10 μ	±10, ±20	5	150	0.85±0.10	

【Temperature Characteristic C6 : X6S (−55~+105°C)】 2.5mm thickness

New part number	Old part number (for reference)	Rated voltage [V]	Temperature characteristics	Capacitance [F]	Capacitance tolerance [%]	tan δ [%]	HTLT	Thickness ³ [mm]	Note
							Rated voltage x %		
MSASE32MAC6476MPNDT1	EMK325AC6476MM-P	16	X6S	4.7 μ	±20	10	150	2.5±0.30	
MSASL32MAC6107MPNA01	LMK325AC6107MM-P	10	X6S	100 μ	±20	10	150	2.5±0.30	
MSASA32MAC6157MPNDT1	AMK325AC6157MM-P	4	X6S	150 μ	±20	10	150	2.5±0.30	
MSASA32MAC6227MPNDT1	AMK325AC6227MM-P	4	X6S	220 μ	±20	10	150	2.5±0.30	
MSASA32MAC6337MPNDT1	AMK325AC6337MM-PE	4	X6S	330 μ	±20	10	150	2.5±0.30	
MSASP32MAC6227MPNDT1	PMK325AC6227MM-P	2.5	X6S	220 μ	±20	10	200	2.5±0.30	
MSASP32MAC6337MPNDT1	PMK325AC6337MM-P	2.5	X6S	330 μ	±20	10	150	2.5±0.30	

PARTS NUMBER

【Temperature Characteristic C7 : X7S (−55~+125°C)】 2.5mm thickness

New part number	Old part number (for reference)	Rated voltage [V]	Temperature characteristics	Capacitance [F]	Capacitance tolerance [%]	tan δ [%]	HTLT	Thickness ^{*3} [mm]	Note
							Rated voltage x %		
MSASJ32MAC7107MPNA01	JMK325AC7107MM-P	6.3	X7S	100 μ	±20	10	150	2.5±0.30	

【Temperature Characteristic B7 : X7R (−55~+125°C)】 2.5mm thickness

New part number	Old part number (for reference)	Rated voltage [V]	Temperature characteristics	Capacitance [F]	Capacitance tolerance [%]	tan δ [%]	HTLT	Thickness ^{*3} [mm]	Note
							Rated voltage x %		
MSASU32MSB7335□PNA01	UMK325 B7335□M-P	50	X7R	3.3 μ	±10, ±20	3.5	200	2.5±0.20	
MSASU32MSB7475□PNA01	UMK325 B7475□M-P	50	X7R	4.7 μ	±10, ±20	5	150	2.5±0.20	
MSASU32MAB7106□PNA01	UMK325AB7106□M-P	50	X7R	10 μ	±10, ±20	10	150	2.5±0.30	
MSAST32MAB7106□PNA01	TMK325AB7106□M-P	25	X7R	10 μ	±10, ±20	10	200	2.5±0.30	
MSAST32MSB7226□PNB25	TMK325 B7226□M-PR	25	X7R	22 μ	±10, ±20	10	150	2.5±0.20	
MSASE32MSB7226□PNB25	EMK325 B7226□M-PR	16	X7R	22 μ	±10, ±20	10	150	2.5±0.20	
MSASL32MSB7476□PNB25	LMK325 B7476□M-PR	10	X7R	47 μ	±10, ±20	10	150	2.5±0.20	
MSASJ32MSB7476□PNB25	JMK325 B7476□M-PR	6.3	X7R	47 μ	±10, ±20	10	200	2.5±0.20	

【Temperature Characteristic B7 : X7R (−55~+125°C)】 1.9mm thickness

New part number	Old part number (for reference)	Rated voltage [V]	Temperature characteristics	Capacitance [F]	Capacitance tolerance [%]	tan δ [%]	HTLT	Thickness ^{*3} [mm]	Note
							Rated voltage x %		
MSASU32NSB7475□TNB25	UMK325 B7475□N-TR	50	X7R	4.7 μ	±10, ±20	10	150	1.9±0.20	
MSAST32NSB7335□TNA01	TMK325 B7335□N-T	25	X7R	3.3 μ	±10, ±20	3.5	200	1.9±0.20	
MSAST32NSB7475□TNA01	TMK325 B7475□N-T	25	X7R	4.7 μ	±10, ±20	3.5	150	1.9±0.20	
MSAST32NSB7106□TNB25	TMK325 B7106□N-TR	25	X7R	10 μ	±10, ±20	10	150	1.9±0.20	
MSASE32NSB7475□TNA01	EMK325 B7475□N-T	16	X7R	4.7 μ	±10, ±20	3.5	200	1.9±0.20	
MSASE32NSB7106□TNA01	EMK325 B7106□N-T	16	X7R	10 μ	±10, ±20	3.5	150	1.9±0.20	
MSASL32NSB7106□TNA01	LMK325 B7106□N-T	10	X7R	10 μ	±10, ±20	3.5	200	1.9±0.20	

● 4532TYPE

【Temperature Characteristic B5(BJ) : X5R (−55~+85°C)】 2.5mm thickness

New part number	Old part number (for reference)	Rated voltage [V]	Temperature characteristics	Capacitance [F]	Capacitance tolerance [%]	tan δ [%]	HTLT	Thickness ^{*3} [mm]	Note
							Rated voltage x %		
MSASA45MSB5477MTNA01	AMK432 BJ477MM-T	4	X5R	470 μ	±20	10	150	2.5±0.20	

【Temperature Characteristic C6 : X6S (−55~+105°C)】 2.5mm thickness

New part number	Old part number (for reference)	Rated voltage [V]	Temperature characteristics	Capacitance [F]	Capacitance tolerance [%]	tan δ [%]	HTLT	Thickness ^{*3} [mm]	Note
							Rated voltage x %		
MSASP45MSC6477MTNA01	PMK432 C6477MM-T	2.5	X6S	470 μ	±20	10	150	2.5±0.20	

PARTS NUMBER

New part number	Old part number (for reference)	Rated voltage [V]	Temperature characteristics		Capacitance [F]	Capacitance tolerance	Q (at 1MHz) (min)	HTLT	Thickness ³ [mm]	Note
								Rated voltage x %		
MSAST021SCG5R2[WNA01	TMK021 CG5R2[K-W	25	CG	C0G	5.2 p	±0.25pF,±0.5pF	504	200	0.125±0.013	
MSAST021SCG5R3[WNA01	TMK021 CG5R3[K-W	25	CG	C0G	5.3 p	±0.25pF,±0.5pF	506	200	0.125±0.013	
MSAST021SCG5R4[WNA01	TMK021 CG5R4[K-W	25	CG	C0G	5.4 p	±0.25pF,±0.5pF	508	200	0.125±0.013	
MSAST021SCG5R5[WNA01	TMK021 CG5R5[K-W	25	CG	C0G	5.5 p	±0.25pF,±0.5pF	510	200	0.125±0.013	
MSAST021SCG5R6[WNA01	TMK021 CG5R6[K-W	25	CG	C0G	5.6 p	±0.25pF,±0.5pF	512	200	0.125±0.013	
MSAST021SCG5R7[WNA01	TMK021 CG5R7[K-W	25	CG	C0G	5.7 p	±0.25pF,±0.5pF	514	200	0.125±0.013	
MSAST021SCG5R8[WNA01	TMK021 CG5R8[K-W	25	CG	C0G	5.8 p	±0.25pF,±0.5pF	516	200	0.125±0.013	
MSAST021SCG5R9[WNA01	TMK021 CG5R9[K-W	25	CG	C0G	5.9 p	±0.25pF,±0.5pF	518	200	0.125±0.013	
MSAST021SCG060[WNA01	TMK021 CG060[K-W	25	CG	C0G	6 p	±0.25pF,±0.5pF	520	200	0.125±0.013	
MSAST021SCG6R1[WNA01	TMK021 CG6R1[K-W	25	CG	C0G	6.1 p	±0.25pF,±0.5pF	522	200	0.125±0.013	
MSAST021SCG6R2[WNA01	TMK021 CG6R2[K-W	25	CG	C0G	6.2 p	±0.25pF,±0.5pF	524	200	0.125±0.013	
MSAST021SCG6R3[WNA01	TMK021 CG6R3[K-W	25	CG	C0G	6.3 p	±0.25pF,±0.5pF	526	200	0.125±0.013	
MSAST021SCG6R4[WNA01	TMK021 CG6R4[K-W	25	CG	C0G	6.4 p	±0.25pF,±0.5pF	528	200	0.125±0.013	
MSAST021SCG6R5[WNA01	TMK021 CG6R5[K-W	25	CG	C0G	6.5 p	±0.25pF,±0.5pF	530	200	0.125±0.013	
MSAST021SCG6R6[WNA01	TMK021 CG6R6[K-W	25	CG	C0G	6.6 p	±0.25pF,±0.5pF	532	200	0.125±0.013	
MSAST021SCG6R7[WNA01	TMK021 CG6R7[K-W	25	CG	C0G	6.7 p	±0.25pF,±0.5pF	534	200	0.125±0.013	
MSAST021SCG6R8[WNA01	TMK021 CG6R8[K-W	25	CG	C0G	6.8 p	±0.25pF,±0.5pF	536	200	0.125±0.013	
MSAST021SCG6R9[WNA01	TMK021 CG6R9[K-W	25	CG	C0G	6.9 p	±0.25pF,±0.5pF	538	200	0.125±0.013	
MSAST021SCG070[WNA01	TMK021 CG070[K-W	25	CG	C0G	7 p	±0.25pF,±0.5pF	540	200	0.125±0.013	
MSAST021SCG7R1[WNA01	TMK021 CG7R1[K-W	25	CG	C0G	7.1 p	±0.25pF,±0.5pF	542	200	0.125±0.013	
MSAST021SCG7R2[WNA01	TMK021 CG7R2[K-W	25	CG	C0G	7.2 p	±0.25pF,±0.5pF	544	200	0.125±0.013	
MSAST021SCG7R3[WNA01	TMK021 CG7R3[K-W	25	CG	C0G	7.3 p	±0.25pF,±0.5pF	546	200	0.125±0.013	
MSAST021SCG7R4[WNA01	TMK021 CG7R4[K-W	25	CG	C0G	7.4 p	±0.25pF,±0.5pF	548	200	0.125±0.013	
MSAST021SCG7R5[WNA01	TMK021 CG7R5[K-W	25	CG	C0G	7.5 p	±0.25pF,±0.5pF	550	200	0.125±0.013	
MSAST021SCG7R6[WNA01	TMK021 CG7R6[K-W	25	CG	C0G	7.6 p	±0.25pF,±0.5pF	552	200	0.125±0.013	
MSAST021SCG7R7[WNA01	TMK021 CG7R7[K-W	25	CG	C0G	7.7 p	±0.25pF,±0.5pF	554	200	0.125±0.013	
MSAST021SCG7R8[WNA01	TMK021 CG7R8[K-W	25	CG	C0G	7.8 p	±0.25pF,±0.5pF	556	200	0.125±0.013	
MSAST021SCG7R9[WNA01	TMK021 CG7R9[K-W	25	CG	C0G	7.9 p	±0.25pF,±0.5pF	558	200	0.125±0.013	
MSAST021SCG080[WNA01	TMK021 CG080[K-W	25	CG	C0G	8 p	±0.25pF,±0.5pF	560	200	0.125±0.013	
MSAST021SCG8R1[WNA01	TMK021 CG8R1[K-W	25	CG	C0G	8.1 p	±0.25pF,±0.5pF	562	200	0.125±0.013	
MSAST021SCG8R2[WNA01	TMK021 CG8R2[K-W	25	CG	C0G	8.2 p	±0.25pF,±0.5pF	564	200	0.125±0.013	
MSAST021SCG8R3[WNA01	TMK021 CG8R3[K-W	25	CG	C0G	8.3 p	±0.25pF,±0.5pF	566	200	0.125±0.013	
MSAST021SCG8R4[WNA01	TMK021 CG8R4[K-W	25	CG	C0G	8.4 p	±0.25pF,±0.5pF	568	200	0.125±0.013	
MSAST021SCG8R5[WNA01	TMK021 CG8R5[K-W	25	CG	C0G	8.5 p	±0.25pF,±0.5pF	570	200	0.125±0.013	
MSAST021SCG8R6[WNA01	TMK021 CG8R6[K-W	25	CG	C0G	8.6 p	±0.25pF,±0.5pF	572	200	0.125±0.013	
MSAST021SCG8R7[WNA01	TMK021 CG8R7[K-W	25	CG	C0G	8.7 p	±0.25pF,±0.5pF	574	200	0.125±0.013	
MSAST021SCG8R8[WNA01	TMK021 CG8R8[K-W	25	CG	C0G	8.8 p	±0.25pF,±0.5pF	576	200	0.125±0.013	
MSAST021SCG8R9[WNA01	TMK021 CG8R9[K-W	25	CG	C0G	8.9 p	±0.25pF,±0.5pF	578	200	0.125±0.013	
MSAST021SCG090[WNA01	TMK021 CG090[K-W	25	CG	C0G	9 p	±0.25pF,±0.5pF	580	200	0.125±0.013	
MSAST021SCG9R1[WNA01	TMK021 CG9R1[K-W	25	CG	C0G	9.1 p	±0.25pF,±0.5pF	582	200	0.125±0.013	
MSAST021SCG9R2[WNA01	TMK021 CG9R2[K-W	25	CG	C0G	9.2 p	±0.25pF,±0.5pF	584	200	0.125±0.013	
MSAST021SCG9R3[WNA01	TMK021 CG9R3[K-W	25	CG	C0G	9.3 p	±0.25pF,±0.5pF	586	200	0.125±0.013	
MSAST021SCG9R4[WNA01	TMK021 CG9R4[K-W	25	CG	C0G	9.4 p	±0.25pF,±0.5pF	588	200	0.125±0.013	
MSAST021SCG9R5[WNA01	TMK021 CG9R5[K-W	25	CG	C0G	9.5 p	±0.25pF,±0.5pF	590	200	0.125±0.013	
MSAST021SCG9R6[WNA01	TMK021 CG9R6[K-W	25	CG	C0G	9.6 p	±0.25pF,±0.5pF	592	200	0.125±0.013	
MSAST021SCG9R7[WNA01	TMK021 CG9R7[K-W	25	CG	C0G	9.7 p	±0.25pF,±0.5pF	594	200	0.125±0.013	
MSAST021SCG9R8[WNA01	TMK021 CG9R8[K-W	25	CG	C0G	9.8 p	±0.25pF,±0.5pF	596	200	0.125±0.013	
MSAST021SCG9R9[WNA01	TMK021 CG9R9[K-W	25	CG	C0G	9.9 p	±0.25pF,±0.5pF	598	200	0.125±0.013	
MSAST021SCG100[WNA01	TMK021 CG100[K-W	25	CG	C0G	10 p	±0.25pF,±0.5pF	600	200	0.125±0.013	
MSAST021SCG120JWNA01	TMK021 CG120JK-W	25	CG	C0G	12 p	±5%	640	200	0.125±0.013	
MSAST021SCG150JWNA01	TMK021 CG150JK-W	25	CG	C0G	15 p	±5%	700	200	0.125±0.013	
MSAST021SCG180JWNA01	TMK021 CG180JK-W	25	CG	C0G	18 p	±5%	760	200	0.125±0.013	
MSAST021SCG220JWNA01	TMK021 CG220JK-W	25	CG	C0G	22 p	±5%	840	200	0.125±0.013	
MSAST021SCG270JWNA01	TMK021 CG270JK-W	25	CG	C0G	27 p	±5%	940	200	0.125±0.013	
MSASE021SCG330JWNA01	EMK021 CG330JK-W	16	CG	C0G	33 p	±5%	1000	150	0.125±0.013	
MSASE021SCG390JWNA01	EMK021 CG390JK-W	16	CG	C0G	39 p	±5%	1000	150	0.125±0.013	
MSASE021SCG470JWNA01	EMK021 CG470JK-W	16	CG	C0G	47 p	±5%	1000	150	0.125±0.013	
MSASE021SCG560JWNA01	EMK021 CG560JK-W	16	CG	C0G	56 p	±5%	1000	150	0.125±0.013	
MSASL021SCG680JWNA01	LMK021 CG680JK-W	10	CG	C0G	68 p	±5%	1000	200	0.125±0.013	
MSASL021SCG820JWNA01	LMK021 CG820JK-W	10	CG	C0G	82 p	±5%	1000	200	0.125±0.013	
MSASL021SCG101JWNA01	LMK021 CG101JK-W	10	CG	C0G	100 p	±5%	1000	200	0.125±0.013	

PARTS NUMBER

0603TYPE

【Temperature Characteristic $C\Delta : C\Delta/C0\Delta (-55\sim +125^{\circ}C)$ 】 0.3mm thickness

New part number	Old part number (for reference)	Rated voltage [V]	Temperature characteristics	Capacitance [F]	Capacitance tolerance	Q (at 1MHz) (min)	HLLT		Thickness*3 [mm]	Note
							Rated voltage x %			
MSASU063SCH200JFNA01	UMK063 CH200JT-F	50	CH C0H	20 p	±5%	800	200		0.3±0.03	
MSASU063SCH220JFNA01	UMK063 CH220JT-F	50	CH C0H	22 p	±5%	840	200		0.3±0.03	
MSASU063SCH240JFNA01	UMK063 CH240JT-F	50	CH C0H	24 p	±5%	880	200		0.3±0.03	
MSASU063SCH270JFNA01	UMK063 CH270JT-F	50	CH C0H	27 p	±5%	940	200		0.3±0.03	
MSASU063SCH300JFNA01	UMK063 CH300JT-F	50	CH C0H	30 p	±5%	1000	200		0.3±0.03	
MSASU063SCH330JFNA01	UMK063 CH330JT-F	50	CH C0H	33 p	±5%	1000	200		0.3±0.03	
MSASU063SCH360JFNA01	UMK063 CH360JT-F	50	CH C0H	36 p	±5%	1000	200		0.3±0.03	
MSASU063SCH390JFNA01	UMK063 CH390JT-F	50	CH C0H	39 p	±5%	1000	200		0.3±0.03	
MSASU063SCH430JFNA01	UMK063 CH430JT-F	50	CH C0H	43 p	±5%	1000	200		0.3±0.03	
MSASU063SCH470JFNA01	UMK063 CH470JT-F	50	CH C0H	47 p	±5%	1000	200		0.3±0.03	
MSASU063SCH510JFNA01	UMK063 CH510JT-F	50	CH C0H	51 p	±5%	1000	200		0.3±0.03	
MSASU063SCH560JFNA01	UMK063 CH560JT-F	50	CH C0H	56 p	±5%	1000	200		0.3±0.03	
MSASU063SCH620JFNA01	UMK063 CH620JT-F	50	CH C0H	62 p	±5%	1000	200		0.3±0.03	
MSASU063SCH680JFNA01	UMK063 CH680JT-F	50	CH C0H	68 p	±5%	1000	200		0.3±0.03	
MSASU063SCH750JFNA01	UMK063 CH750JT-F	50	CH C0H	75 p	±5%	1000	200		0.3±0.03	
MSASU063SCH820JFNA01	UMK063 CH820JT-F	50	CH C0H	82 p	±5%	1000	200		0.3±0.03	
MSASU063SCH910JFNA01	UMK063 CH910JT-F	50	CH C0H	91 p	±5%	1000	200		0.3±0.03	
MSASU063SCH101JFNA01	UMK063 CH101JT-F	50	CH C0H	100 p	±5%	1000	200		0.3±0.03	
MSASU063SCH111JFNA01	UMK063 CH111JT-F	50	CH C0H	110 p	±5%	1000	200		0.3±0.03	
MSASU063SCH121JFNA01	UMK063 CH121JT-F	50	CH C0H	120 p	±5%	1000	200		0.3±0.03	
MSASU063SCH131JFNA01	UMK063 CH131JT-F	50	CH C0H	130 p	±5%	1000	200		0.3±0.03	
MSASU063SCH151JFNA01	UMK063 CH151JT-F	50	CH C0H	150 p	±5%	1000	200		0.3±0.03	
MSASU063SCH181JFNA01	UMK063 CH181JT-F	50	CH C0H	180 p	±5%	1000	200		0.3±0.03	
MSASU063SCH201JFNA01	UMK063 CH201JT-F	50	CH C0H	200 p	±5%	1000	200		0.3±0.03	
MSASU063SCH221JFNA01	UMK063 CH221JT-F	50	CH C0H	220 p	±5%	1000	200		0.3±0.03	
MSAST063SCH241JFNA01	TMK063 CH241JT-F	25	CH C0H	240 p	±5%	1000	200		0.3±0.03	
MSAST063SCH271JFNA01	TMK063 CH271JT-F	25	CH C0H	270 p	±5%	1000	200		0.3±0.03	
MSAST063SCH301JFNA01	TMK063 CH301JT-F	25	CH C0H	300 p	±5%	1000	200		0.3±0.03	
MSAST063SCH331JFNA01	TMK063 CH331JT-F	25	CH C0H	330 p	±5%	1000	200		0.3±0.03	
MSAST063SCH361JFNA01	TMK063 CH361JT-F	25	CH C0H	360 p	±5%	1000	200		0.3±0.03	
MSAST063SCH391JFNA01	TMK063 CH391JT-F	25	CH C0H	390 p	±5%	1000	200		0.3±0.03	
MSAST063SCH431JFNA01	TMK063 CH431JT-F	25	CH C0H	430 p	±5%	1000	200		0.3±0.03	
MSAST063SCH471JFNA01	TMK063 CH471JT-F	25	CH C0H	470 p	±5%	1000	200		0.3±0.03	
MSAST063SCH511JFNA01	TMK063 CH511JT-F	25	CH C0H	510 p	±5%	1000	200		0.3±0.03	
MSAST063SCH561JFNA01	TMK063 CH561JT-F	25	CH C0H	560 p	±5%	1000	200		0.3±0.03	
MSAST063SCH621JFNA01	TMK063 CH621JT-F	25	CH C0H	620 p	±5%	1000	200		0.3±0.03	
MSAST063SCH681JFNA01	TMK063 CH681JT-F	25	CH C0H	680 p	±5%	1000	200		0.3±0.03	
MSAST063SCH751JFNA01	TMK063 CH751JT-F	25	CH C0H	750 p	±5%	1000	200		0.3±0.03	
MSAST063SCH821JFNA01	TMK063 CH821JT-F	25	CH C0H	820 p	±5%	1000	200		0.3±0.03	
MSAST063SCH911JFNA01	TMK063 CH911JT-F	25	CH C0H	910 p	±5%	1000	200		0.3±0.03	
MSAST063SCH102JFNA01	TMK063 CH102JT-F	25	CH C0H	1000 p	±5%	1000	200		0.3±0.03	
MSASU063SCG200JFNA01	UMK063 CG200JT-F	50	CG C0G	20 p	±5%	800	200		0.3±0.03	
MSASU063SCG220JFNA01	UMK063 CG220JT-F	50	CG C0G	22 p	±5%	840	200		0.3±0.03	
MSASU063SCG240JFNA01	UMK063 CG240JT-F	50	CG C0G	24 p	±5%	880	200		0.3±0.03	
MSASU063SCG270JFNA01	UMK063 CG270JT-F	50	CG C0G	27 p	±5%	940	200		0.3±0.03	
MSASU063SCG300JFNA01	UMK063 CG300JT-F	50	CG C0G	30 p	±5%	1000	200		0.3±0.03	
MSASU063SCG330JFNA01	UMK063 CG330JT-F	50	CG C0G	33 p	±5%	1000	200		0.3±0.03	
MSASU063SCG360JFNA01	UMK063 CG360JT-F	50	CG C0G	36 p	±5%	1000	200		0.3±0.03	
MSASU063SCG390JFNA01	UMK063 CG390JT-F	50	CG C0G	39 p	±5%	1000	200		0.3±0.03	
MSASU063SCG430JFNA01	UMK063 CG430JT-F	50	CG C0G	43 p	±5%	1000	200		0.3±0.03	
MSASU063SCG470JFNA01	UMK063 CG470JT-F	50	CG C0G	47 p	±5%	1000	200		0.3±0.03	
MSASU063SCG510JFNA01	UMK063 CG510JT-F	50	CG C0G	51 p	±5%	1000	200		0.3±0.03	
MSASU063SCG560JFNA01	UMK063 CG560JT-F	50	CG C0G	56 p	±5%	1000	200		0.3±0.03	
MSASU063SCG620JFNA01	UMK063 CG620JT-F	50	CG C0G	62 p	±5%	1000	200		0.3±0.03	
MSASU063SCG680JFNA01	UMK063 CG680JT-F	50	CG C0G	68 p	±5%	1000	200		0.3±0.03	
MSASU063SCG750JFNA01	UMK063 CG750JT-F	50	CG C0G	75 p	±5%	1000	200		0.3±0.03	
MSASU063SCG820JFNA01	UMK063 CG820JT-F	50	CG C0G	82 p	±5%	1000	200		0.3±0.03	
MSASU063SCG910JFNA01	UMK063 CG910JT-F	50	CG C0G	91 p	±5%	1000	200		0.3±0.03	
MSASU063SCG101JFNA01	UMK063 CG101JT-F	50	CG C0G	100 p	±5%	1000	200		0.3±0.03	
MSASU063SCG111JFNA01	UMK063 CG111JT-F	50	CG C0G	110 p	±5%	1000	200		0.3±0.03	
MSASU063SCG121JFNA01	UMK063 CG121JT-F	50	CG C0G	120 p	±5%	1000	200		0.3±0.03	
MSASU063SCG131JFNA01	UMK063 CG131JT-F	50	CG C0G	130 p	±5%	1000	200		0.3±0.03	
MSASU063SCG151JFNA01	UMK063 CG151JT-F	50	CG C0G	150 p	±5%	1000	200		0.3±0.03	
MSASU063SCG181JFNA01	UMK063 CG181JT-F	50	CG C0G	180 p	±5%	1000	200		0.3±0.03	
MSASU063SCG201JFNA01	UMK063 CG201JT-F	50	CG C0G	200 p	±5%	1000	200		0.3±0.03	
MSASU063SCG221JFNA01	UMK063 CG221JT-F	50	CG C0G	220 p	±5%	1000	200		0.3±0.03	
MSAST063SCG241JFNA01	TMK063 CG241JT-F	25	CG C0G	240 p	±5%	1000	200		0.3±0.03	
MSAST063SCG271JFNA01	TMK063 CG271JT-F	25	CG C0G	270 p	±5%	1000	200		0.3±0.03	
MSAST063SCG301JFNA01	TMK063 CG301JT-F	25	CG C0G	300 p	±5%	1000	200		0.3±0.03	
MSAST063SCG331JFNA01	TMK063 CG331JT-F	25	CG C0G	330 p	±5%	1000	200		0.3±0.03	
MSAST063SCG361JFNA01	TMK063 CG361JT-F	25	CG C0G	360 p	±5%	1000	200		0.3±0.03	
MSAST063SCG391JFNA01	TMK063 CG391JT-F	25	CG C0G	390 p	±5%	1000	200		0.3±0.03	
MSAST063SCG431JFNA01	TMK063 CG431JT-F	25	CG C0G	430 p	±5%	1000	200		0.3±0.03	
MSAST063SCG471JFNA01	TMK063 CG471JT-F	25	CG C0G	470 p	±5%	1000	200		0.3±0.03	
MSAST063SCG511JFNA01	TMK063 CG511JT-F	25	CG C0G	510 p	±5%	1000	200		0.3±0.03	
MSAST063SCG561JFNA01	TMK063 CG561JT-F	25	CG C0G	560 p	±5%	1000	200		0.3±0.03	
MSAST063SCG621JFNA01	TMK063 CG621JT-F	25	CG C0G	620 p	±5%	1000	200		0.3±0.03	
MSAST063SCG681JFNA01	TMK063 CG681JT-F	25	CG C0G	680 p	±5%	1000	200		0.3±0.03	
MSAST063SCG751JFNA01	TMK063 CG751JT-F	25	CG C0G	750 p	±5%	1000	200		0.3±0.03	
MSAST063SCG821JFNA01	TMK063 CG821JT-F	25	CG C0G	820 p	±5%	1000	200		0.3±0.03	
MSAST063SCG911JFNA01	TMK063 CG911JT-F	25	CG C0G	910 p	±5%	1000	200		0.3±0.03	
MSAST063SCG102JFNA01	TMK063 CG102JT-F	25	CG C0G	1000 p	±5%	1000	200		0.3±0.03	

■ PARTS NUMBER

New part number	Old part number (for reference)	Rated voltage [V]	Temperature characteristics		Capacitance [F]	Capacitance tolerance	Q (at 1GHz) (min)	HTLT	Thickness ³ [mm]	Note
								Rated voltage x %		
MSARE021SCH8R3[WRA01	EVS021 CH8R3[K-W	16	CH	C0H	8.3 p	±0.1pF, ±0.25pF, ±0.5pF	50	200	0.125±0.013	
MSARE021SCH8R4[WRA01	EVS021 CH8R4[K-W	16	CH	C0H	8.4 p	±0.1pF, ±0.25pF, ±0.5pF	50	200	0.125±0.013	
MSARE021SCH8R5[WRA01	EVS021 CH8R5[K-W	16	CH	C0H	8.5 p	±0.1pF, ±0.25pF, ±0.5pF	50	200	0.125±0.013	
MSARE021SCH8R6[WRA01	EVS021 CH8R6[K-W	16	CH	C0H	8.6 p	±0.1pF, ±0.25pF, ±0.5pF	50	200	0.125±0.013	
MSARE021SCH8R7[WRA01	EVS021 CH8R7[K-W	16	CH	C0H	8.7 p	±0.1pF, ±0.25pF, ±0.5pF	50	200	0.125±0.013	
MSARE021SCH8R8[WRA01	EVS021 CH8R8[K-W	16	CH	C0H	8.8 p	±0.1pF, ±0.25pF, ±0.5pF	50	200	0.125±0.013	
MSARE021SCH8R9[WRA01	EVS021 CH8R9[K-W	16	CH	C0H	8.9 p	±0.1pF, ±0.25pF, ±0.5pF	50	200	0.125±0.013	
MSARE021SCH090[WRA01	EVS021 CH090[K-W	16	CH	C0H	9 p	±0.1pF, ±0.25pF, ±0.5pF	50	200	0.125±0.013	
MSARE021SCH9R1[WRA01	EVS021 CH9R1[K-W	16	CH	C0H	9.1 p	±0.1pF, ±0.25pF, ±0.5pF	50	200	0.125±0.013	
MSARE021SCH9R2[WRA01	EVS021 CH9R2[K-W	16	CH	C0H	9.2 p	±0.1pF, ±0.25pF, ±0.5pF	50	200	0.125±0.013	
MSARE021SCH9R3[WRA01	EVS021 CH9R3[K-W	16	CH	C0H	9.3 p	±0.1pF, ±0.25pF, ±0.5pF	50	200	0.125±0.013	
MSARE021SCH9R4[WRA01	EVS021 CH9R4[K-W	16	CH	C0H	9.4 p	±0.1pF, ±0.25pF, ±0.5pF	50	200	0.125±0.013	
MSARE021SCH9R5[WRA01	EVS021 CH9R5[K-W	16	CH	C0H	9.5 p	±0.1pF, ±0.25pF, ±0.5pF	50	200	0.125±0.013	
MSARE021SCH9R6[WRA01	EVS021 CH9R6[K-W	16	CH	C0H	9.6 p	±0.1pF, ±0.25pF, ±0.5pF	50	200	0.125±0.013	
MSARE021SCH9R7[WRA01	EVS021 CH9R7[K-W	16	CH	C0H	9.7 p	±0.1pF, ±0.25pF, ±0.5pF	50	200	0.125±0.013	
MSARE021SCH9R8[WRA01	EVS021 CH9R8[K-W	16	CH	C0H	9.8 p	±0.1pF, ±0.25pF, ±0.5pF	40	200	0.125±0.013	
MSARE021SCH9R9[WRA01	EVS021 CH9R9[K-W	16	CH	C0H	9.9 p	±0.1pF, ±0.25pF, ±0.5pF	40	200	0.125±0.013	
MSARE021SCH100[WRA01	EVS021 CH100[K-W	16	CH	C0H	10 p	±2%, ±5%	50	200	0.125±0.013	

【Temperature Characteristic CG : CG/C0G (-55~+125°C)】 0.125mm thickness

New part number	Old part number (for reference)	Rated voltage [V]	Temperature characteristics		Capacitance [F]	Capacitance tolerance	Q (at 1GHz) (min)	HTLT	Thickness ³ [mm]	Note
								Rated voltage x %		
MSART021SCG0R2[WRA01	TVS021 CG0R2[K-W	25	CG	C0G	0.2 p	±0.05pF, ±0.1pF, ±0.25pF	260	200	0.125±0.013	
MSART021SCG0R3[WRA01	TVS021 CG0R3[K-W	25	CG	C0G	0.3 p	±0.05pF, ±0.1pF, ±0.25pF	260	200	0.125±0.013	
MSART021SCG0R4[WRA01	TVS021 CG0R4[K-W	25	CG	C0G	0.4 p	±0.05pF, ±0.1pF, ±0.25pF	260	200	0.125±0.013	
MSART021SCG0R5[WRA01	TVS021 CG0R5[K-W	25	CG	C0G	0.5 p	±0.05pF, ±0.1pF, ±0.25pF	260	200	0.125±0.013	
MSART021SCG0R6[WRA01	TVS021 CG0R6[K-W	25	CG	C0G	0.6 p	±0.05pF, ±0.1pF, ±0.25pF	260	200	0.125±0.013	
MSART021SCG0R7[WRA01	TVS021 CG0R7[K-W	25	CG	C0G	0.7 p	±0.05pF, ±0.1pF, ±0.25pF	260	200	0.125±0.013	
MSART021SCG0R75[WRA01	TVS021 CG0R75[K-W	25	CG	C0G	0.75 p	±0.05pF, ±0.1pF, ±0.25pF	260	200	0.125±0.013	
MSART021SCG0R8[WRA01	TVS021 CG0R8[K-W	25	CG	C0G	0.8 p	±0.05pF, ±0.1pF, ±0.25pF	260	200	0.125±0.013	
MSART021SCG0R9[WRA01	TVS021 CG0R9[K-W	25	CG	C0G	0.9 p	±0.05pF, ±0.1pF, ±0.25pF	260	200	0.125±0.013	
MSART021SCG010[WRA01	TVS021 CG010[K-W	25	CG	C0G	1 p	±0.05pF, ±0.1pF, ±0.25pF	260	200	0.125±0.013	
MSART021SCG1R1[WRA01	TVS021 CG1R1[K-W	25	CG	C0G	1.1 p	±0.05pF, ±0.1pF, ±0.25pF	260	200	0.125±0.013	
MSART021SCG1R2[WRA01	TVS021 CG1R2[K-W	25	CG	C0G	1.2 p	±0.05pF, ±0.1pF, ±0.25pF	250	200	0.125±0.013	
MSART021SCG1R3[WRA01	TVS021 CG1R3[K-W	25	CG	C0G	1.3 p	±0.05pF, ±0.1pF, ±0.25pF	230	200	0.125±0.013	
MSART021SCG1R4[WRA01	TVS021 CG1R4[K-W	25	CG	C0G	1.4 p	±0.05pF, ±0.1pF, ±0.25pF	220	200	0.125±0.013	
MSART021SCG1R5[WRA01	TVS021 CG1R5[K-W	25	CG	C0G	1.5 p	±0.05pF, ±0.1pF, ±0.25pF	210	200	0.125±0.013	
MSART021SCG1R6[WRA01	TVS021 CG1R6[K-W	25	CG	C0G	1.6 p	±0.05pF, ±0.1pF, ±0.25pF	190	200	0.125±0.013	
MSART021SCG1R7[WRA01	TVS021 CG1R7[K-W	25	CG	C0G	1.7 p	±0.05pF, ±0.1pF, ±0.25pF	190	200	0.125±0.013	
MSART021SCG1R8[WRA01	TVS021 CG1R8[K-W	25	CG	C0G	1.8 p	±0.05pF, ±0.1pF, ±0.25pF	180	200	0.125±0.013	
MSART021SCG1R9[WRA01	TVS021 CG1R9[K-W	25	CG	C0G	1.9 p	±0.05pF, ±0.1pF, ±0.25pF	170	200	0.125±0.013	
MSART021SCG020[WRA01	TVS021 CG020[K-W	25	CG	C0G	2 p	±0.05pF, ±0.1pF, ±0.25pF	160	200	0.125±0.013	
MSART021SCG2R1[WRA01	TVS021 CG2R1[K-W	25	CG	C0G	2.1 p	±0.05pF, ±0.1pF, ±0.25pF	160	200	0.125±0.013	
MSART021SCG2R2[WRA01	TVS021 CG2R2[K-W	25	CG	C0G	2.2 p	±0.05pF, ±0.1pF, ±0.25pF	150	200	0.125±0.013	
MSART021SCG2R3[WRA01	TVS021 CG2R3[K-W	25	CG	C0G	2.3 p	±0.05pF, ±0.1pF, ±0.25pF	150	200	0.125±0.013	
MSART021SCG2R4[WRA01	TVS021 CG2R4[K-W	25	CG	C0G	2.4 p	±0.05pF, ±0.1pF, ±0.25pF	140	200	0.125±0.013	
MSART021SCG2R5[WRA01	TVS021 CG2R5[K-W	25	CG	C0G	2.5 p	±0.05pF, ±0.1pF, ±0.25pF	140	200	0.125±0.013	
MSART021SCG2R6[WRA01	TVS021 CG2R6[K-W	25	CG	C0G	2.6 p	±0.05pF, ±0.1pF, ±0.25pF	130	200	0.125±0.013	
MSART021SCG2R7[WRA01	TVS021 CG2R7[K-W	25	CG	C0G	2.7 p	±0.05pF, ±0.1pF, ±0.25pF	130	200	0.125±0.013	
MSART021SCG2R8[WRA01	TVS021 CG2R8[K-W	25	CG	C0G	2.8 p	±0.05pF, ±0.1pF, ±0.25pF	120	200	0.125±0.013	
MSART021SCG2R9[WRA01	TVS021 CG2R9[K-W	25	CG	C0G	2.9 p	±0.05pF, ±0.1pF, ±0.25pF	120	200	0.125±0.013	
MSART021SCG030[WRA01	TVS021 CG030[K-W	25	CG	C0G	3 p	±0.1pF, ±0.25pF, ±0.5pF	120	200	0.125±0.013	
MSART021SCG3R1[WRA01	TVS021 CG3R1[K-W	25	CG	C0G	3.1 p	±0.1pF, ±0.25pF, ±0.5pF	110	200	0.125±0.013	
MSART021SCG3R2[WRA01	TVS021 CG3R2[K-W	25	CG	C0G	3.2 p	±0.1pF, ±0.25pF, ±0.5pF	110	200	0.125±0.013	
MSART021SCG3R3[WRA01	TVS021 CG3R3[K-W	25	CG	C0G	3.3 p	±0.1pF, ±0.25pF, ±0.5pF	110	200	0.125±0.013	
MSART021SCG3R4[WRA01	TVS021 CG3R4[K-W	25	CG	C0G	3.4 p	±0.1pF, ±0.25pF, ±0.5pF	110	200	0.125±0.013	
MSART021SCG3R5[WRA01	TVS021 CG3R5[K-W	25	CG	C0G	3.5 p	±0.1pF, ±0.25pF, ±0.5pF	100	200	0.125±0.013	
MSART021SCG3R6[WRA01	TVS021 CG3R6[K-W	25	CG	C0G	3.6 p	±0.1pF, ±0.25pF, ±0.5pF	100	200	0.125±0.013	
MSART021SCG3R7[WRA01	TVS021 CG3R7[K-W	25	CG	C0G	3.7 p	±0.1pF, ±0.25pF, ±0.5pF	100	200	0.125±0.013	
MSART021SCG3R8[WRA01	TVS021 CG3R8[K-W	25	CG	C0G	3.8 p	±0.1pF, ±0.25pF, ±0.5pF	100	200	0.125±0.013	
MSART021SCG3R9[WRA01	TVS021 CG3R9[K-W	25	CG	C0G	3.9 p	±0.1pF, ±0.25pF, ±0.5pF	90	200	0.125±0.013	
MSART021SCG040[WRA01	TVS021 CG040[K-W	25	CG	C0G	4 p	±0.1pF, ±0.25pF, ±0.5pF	90	200	0.125±0.013	
MSART021SCG4R1[WRA01	TVS021 CG4R1[K-W	25	CG	C0G	4.1 p	±0.1pF, ±0.25pF, ±0.5pF	90	200	0.125±0.013	
MSART021SCG4R2[WRA01	TVS021 CG4R2[K-W	25	CG	C0G	4.2 p	±0.1pF, ±0.25pF, ±0.5pF	90	200	0.125±0.013	
MSART021SCG4R3[WRA01	TVS021 CG4R3[K-W	25	CG	C0G	4.3 p	±0.1pF, ±0.25pF, ±0.5pF	90	200	0.125±0.013	
MSART021SCG4R4[WRA01	TVS021 CG4R4[K-W	25	CG	C0G	4.4 p	±0.1pF, ±0.25pF, ±0.5pF	90	200	0.125±0.013	
MSART021SCG4R5[WRA01	TVS021 CG4R5[K-W	25	CG	C0G	4.5 p	±0.1pF, ±0.25pF, ±0.5pF	80	200	0.125±0.013	
MSART021SCG4R6[WRA01	TVS021 CG4R6[K-W	25	CG	C0G	4.6 p	±0.1pF, ±0.25pF, ±0.5pF	80	200	0.125±0.013	
MSART021SCG4R7[WRA01	TVS021 CG4R7[K-W	25	CG	C0G	4.7 p	±0.1pF, ±0.25pF, ±0.5pF	80	200	0.125±0.013	
MSART021SCG4R8[WRA01	TVS021 CG4R8[K-W	25	CG	C0G	4.8 p	±0.1pF, ±0.25pF, ±0.5pF	80	200	0.125±0.013	
MSART021SCG4R9[WRA01	TVS021 CG4R9[K-W	25	CG	C0G	4.9 p	±0.1pF, ±0.25pF, ±0.5pF	80	200	0.125±0.013	
MSART021SCG050[WRA01	TVS021 CG050[K-W	25	CG	C0G	5 p	±0.1pF, ±0.25pF, ±0.5pF	80	200	0.125±0.013	
MSART021SCG5R1[WRA01	TVS021 CG5R1[K-W	25	CG	C0G	5.1 p	±0.1pF, ±0.25pF, ±0.5pF	80	200	0.125±0.013	

▶ This catalog contains the typical specification only due to the limitation of space. When you consider the purchase of our products, please check our specification.
For details of each product (characteristics graph, reliability information, precautions for use, and so on), see our Web site (<http://www.ty-top.com/>).

PARTS NUMBER

New part number	Old part number (for reference)	Rated voltage [V]	Temperature characteristics		Capacitance [F]	Capacitance tolerance	Q (at 1 GHz) (min)	HTLT	Thickness ³⁾ [mm]	Note
								Rated voltage x %		
MSART042SCH3R1[WRA01	TVS042 CH3R1[C-W	25	CH	C0H	3.1 p	±0.1pF, ±0.25pF	125	200	0.2±0.02	
MSART042SCH3R2[WRA01	TVS042 CH3R2[C-W	25	CH	C0H	3.2 p	±0.1pF, ±0.25pF	125	200	0.2±0.02	
MSART042SCH3R3[WRA01	TVS042 CH3R3[C-W	25	CH	C0H	3.3 p	±0.1pF, ±0.25pF	120	200	0.2±0.02	
MSART042SCH3R4[WRA01	TVS042 CH3R4[C-W	25	CH	C0H	3.4 p	±0.1pF, ±0.25pF	120	200	0.2±0.02	
MSART042SCH3R5[WRA01	TVS042 CH3R5[C-W	25	CH	C0H	3.5 p	±0.1pF, ±0.25pF	110	200	0.2±0.02	
MSART042SCH3R6[WRA01	TVS042 CH3R6[C-W	25	CH	C0H	3.6 p	±0.1pF, ±0.25pF	110	200	0.2±0.02	
MSART042SCH3R7[WRA01	TVS042 CH3R7[C-W	25	CH	C0H	3.7 p	±0.1pF, ±0.25pF	110	200	0.2±0.02	
MSART042SCH3R8[WRA01	TVS042 CH3R8[C-W	25	CH	C0H	3.8 p	±0.1pF, ±0.25pF	100	200	0.2±0.02	
MSART042SCH3R9[WRA01	TVS042 CH3R9[C-W	25	CH	C0H	3.9 p	±0.1pF, ±0.25pF	100	200	0.2±0.02	
MSART042SCH040[WRA01	TVS042 CH040[C-W	25	CH	C0H	4 p	±0.1pF, ±0.25pF	90	200	0.2±0.02	
MSART042SCH4R1[WRA01	TVS042 CH4R1[C-W	25	CH	C0H	4.1 p	±0.1pF, ±0.25pF	90	200	0.2±0.02	
MSART042SCH4R2[WRA01	TVS042 CH4R2[C-W	25	CH	C0H	4.2 p	±0.1pF, ±0.25pF	85	200	0.2±0.02	
MSART042SCH4R3[WRA01	TVS042 CH4R3[C-W	25	CH	C0H	4.3 p	±0.1pF, ±0.25pF	85	200	0.2±0.02	
MSART042SCH4R4[WRA01	TVS042 CH4R4[C-W	25	CH	C0H	4.4 p	±0.1pF, ±0.25pF	85	200	0.2±0.02	
MSART042SCH4R5[WRA01	TVS042 CH4R5[C-W	25	CH	C0H	4.5 p	±0.1pF, ±0.25pF	85	200	0.2±0.02	
MSART042SCH4R6[WRA01	TVS042 CH4R6[C-W	25	CH	C0H	4.6 p	±0.1pF, ±0.25pF	85	200	0.2±0.02	
MSART042SCH4R7[WRA01	TVS042 CH4R7[C-W	25	CH	C0H	4.7 p	±0.1pF, ±0.25pF	85	200	0.2±0.02	
MSART042SCH4R8[WRA01	TVS042 CH4R8[C-W	25	CH	C0H	4.8 p	±0.1pF, ±0.25pF	80	200	0.2±0.02	
MSART042SCH4R9[WRA01	TVS042 CH4R9[C-W	25	CH	C0H	4.9 p	±0.1pF, ±0.25pF	80	200	0.2±0.02	
MSART042SCH050[WRA01	TVS042 CH050[C-W	25	CH	C0H	5 p	±0.1pF, ±0.25pF	80	200	0.2±0.02	
MSART042SCH5R1[WRA01	TVS042 CH5R1[C-W	25	CH	C0H	5.1 p	±0.1pF, ±0.25pF, ±0.5pF	75	200	0.2±0.02	
MSART042SCH5R2[WRA01	TVS042 CH5R2[C-W	25	CH	C0H	5.2 p	±0.1pF, ±0.25pF, ±0.5pF	75	200	0.2±0.02	
MSART042SCH5R3[WRA01	TVS042 CH5R3[C-W	25	CH	C0H	5.3 p	±0.1pF, ±0.25pF, ±0.5pF	75	200	0.2±0.02	
MSART042SCH5R4[WRA01	TVS042 CH5R4[C-W	25	CH	C0H	5.4 p	±0.1pF, ±0.25pF, ±0.5pF	70	200	0.2±0.02	
MSART042SCH5R5[WRA01	TVS042 CH5R5[C-W	25	CH	C0H	5.5 p	±0.1pF, ±0.25pF, ±0.5pF	70	200	0.2±0.02	
MSART042SCH5R6[WRA01	TVS042 CH5R6[C-W	25	CH	C0H	5.6 p	±0.1pF, ±0.25pF, ±0.5pF	70	200	0.2±0.02	
MSART042SCH5R7[WRA01	TVS042 CH5R7[C-W	25	CH	C0H	5.7 p	±0.1pF, ±0.25pF, ±0.5pF	70	200	0.2±0.02	
MSART042SCH5R8[WRA01	TVS042 CH5R8[C-W	25	CH	C0H	5.8 p	±0.1pF, ±0.25pF, ±0.5pF	70	200	0.2±0.02	
MSART042SCH5R9[WRA01	TVS042 CH5R9[C-W	25	CH	C0H	5.9 p	±0.1pF, ±0.25pF, ±0.5pF	65	200	0.2±0.02	
MSART042SCH060[WRA01	TVS042 CH060[C-W	25	CH	C0H	6 p	±0.1pF, ±0.25pF, ±0.5pF	65	200	0.2±0.02	
MSART042SCH6R1[WRA01	TVS042 CH6R1[C-W	25	CH	C0H	6.1 p	±0.1pF, ±0.25pF, ±0.5pF	65	200	0.2±0.02	
MSART042SCH6R2[WRA01	TVS042 CH6R2[C-W	25	CH	C0H	6.2 p	±0.1pF, ±0.25pF, ±0.5pF	65	200	0.2±0.02	
MSART042SCH6R3[WRA01	TVS042 CH6R3[C-W	25	CH	C0H	6.3 p	±0.1pF, ±0.25pF, ±0.5pF	65	200	0.2±0.02	
MSART042SCH6R4[WRA01	TVS042 CH6R4[C-W	25	CH	C0H	6.4 p	±0.1pF, ±0.25pF, ±0.5pF	65	200	0.2±0.02	
MSART042SCH6R5[WRA01	TVS042 CH6R5[C-W	25	CH	C0H	6.5 p	±0.1pF, ±0.25pF, ±0.5pF	65	200	0.2±0.02	
MSART042SCH6R6[WRA01	TVS042 CH6R6[C-W	25	CH	C0H	6.6 p	±0.1pF, ±0.25pF, ±0.5pF	60	200	0.2±0.02	
MSART042SCH6R7[WRA01	TVS042 CH6R7[C-W	25	CH	C0H	6.7 p	±0.1pF, ±0.25pF, ±0.5pF	60	200	0.2±0.02	
MSART042SCH6R8[WRA01	TVS042 CH6R8[C-W	25	CH	C0H	6.8 p	±0.1pF, ±0.25pF, ±0.5pF	60	200	0.2±0.02	
MSART042SCH6R9[WRA01	TVS042 CH6R9[C-W	25	CH	C0H	6.9 p	±0.1pF, ±0.25pF, ±0.5pF	60	200	0.2±0.02	
MSART042SCH070[WRA01	TVS042 CH070[C-W	25	CH	C0H	7 p	±0.1pF, ±0.25pF, ±0.5pF	60	200	0.2±0.02	
MSART042SCH7R1[WRA01	TVS042 CH7R1[C-W	25	CH	C0H	7.1 p	±0.1pF, ±0.25pF, ±0.5pF	60	200	0.2±0.02	
MSART042SCH7R2[WRA01	TVS042 CH7R2[C-W	25	CH	C0H	7.2 p	±0.1pF, ±0.25pF, ±0.5pF	60	200	0.2±0.02	
MSART042SCH7R3[WRA01	TVS042 CH7R3[C-W	25	CH	C0H	7.3 p	±0.1pF, ±0.25pF, ±0.5pF	55	200	0.2±0.02	
MSART042SCH7R4[WRA01	TVS042 CH7R4[C-W	25	CH	C0H	7.4 p	±0.1pF, ±0.25pF, ±0.5pF	55	200	0.2±0.02	
MSART042SCH7R5[WRA01	TVS042 CH7R5[C-W	25	CH	C0H	7.5 p	±0.1pF, ±0.25pF, ±0.5pF	55	200	0.2±0.02	
MSART042SCH7R6[WRA01	TVS042 CH7R6[C-W	25	CH	C0H	7.6 p	±0.1pF, ±0.25pF, ±0.5pF	55	200	0.2±0.02	
MSART042SCH7R7[WRA01	TVS042 CH7R7[C-W	25	CH	C0H	7.7 p	±0.1pF, ±0.25pF, ±0.5pF	55	200	0.2±0.02	
MSART042SCH7R8[WRA01	TVS042 CH7R8[C-W	25	CH	C0H	7.8 p	±0.1pF, ±0.25pF, ±0.5pF	55	200	0.2±0.02	
MSART042SCH7R9[WRA01	TVS042 CH7R9[C-W	25	CH	C0H	7.9 p	±0.1pF, ±0.25pF, ±0.5pF	55	200	0.2±0.02	
MSART042SCH080[WRA01	TVS042 CH080[C-W	25	CH	C0H	8 p	±0.1pF, ±0.25pF, ±0.5pF	55	200	0.2±0.02	
MSART042SCH8R1[WRA01	TVS042 CH8R1[C-W	25	CH	C0H	8.1 p	±0.1pF, ±0.25pF, ±0.5pF	55	200	0.2±0.02	
MSART042SCH8R2[WRA01	TVS042 CH8R2[C-W	25	CH	C0H	8.2 p	±0.1pF, ±0.25pF, ±0.5pF	50	200	0.2±0.02	
MSART042SCH8R3[WRA01	TVS042 CH8R3[C-W	25	CH	C0H	8.3 p	±0.1pF, ±0.25pF, ±0.5pF	50	200	0.2±0.02	
MSART042SCH8R4[WRA01	TVS042 CH8R4[C-W	25	CH	C0H	8.4 p	±0.1pF, ±0.25pF, ±0.5pF	50	200	0.2±0.02	
MSART042SCH8R5[WRA01	TVS042 CH8R5[C-W	25	CH	C0H	8.5 p	±0.1pF, ±0.25pF, ±0.5pF	50	200	0.2±0.02	
MSART042SCH8R6[WRA01	TVS042 CH8R6[C-W	25	CH	C0H	8.6 p	±0.1pF, ±0.25pF, ±0.5pF	50	200	0.2±0.02	
MSART042SCH8R7[WRA01	TVS042 CH8R7[C-W	25	CH	C0H	8.7 p	±0.1pF, ±0.25pF, ±0.5pF	50	200	0.2±0.02	
MSART042SCH8R8[WRA01	TVS042 CH8R8[C-W	25	CH	C0H	8.8 p	±0.1pF, ±0.25pF, ±0.5pF	50	200	0.2±0.02	
MSART042SCH8R9[WRA01	TVS042 CH8R9[C-W	25	CH	C0H	8.9 p	±0.1pF, ±0.25pF, ±0.5pF	50	200	0.2±0.02	
MSART042SCH090[WRA01	TVS042 CH090[C-W	25	CH	C0H	9 p	±0.1pF, ±0.25pF, ±0.5pF	50	200	0.2±0.02	
MSART042SCH9R1[WRA01	TVS042 CH9R1[C-W	25	CH	C0H	9.1 p	±0.1pF, ±0.25pF, ±0.5pF	45	200	0.2±0.02	
MSART042SCH9R2[WRA01	TVS042 CH9R2[C-W	25	CH	C0H	9.2 p	±0.1pF, ±0.25pF, ±0.5pF	45	200	0.2±0.02	
MSART042SCH9R3[WRA01	TVS042 CH9R3[C-W	25	CH	C0H	9.3 p	±0.1pF, ±0.25pF, ±0.5pF	45	200	0.2±0.02	
MSART042SCH9R4[WRA01	TVS042 CH9R4[C-W	25	CH	C0H	9.4 p	±0.1pF, ±0.25pF, ±0.5pF	45	200	0.2±0.02	
MSART042SCH9R5[WRA01	TVS042 CH9R5[C-W	25	CH	C0H	9.5 p	±0.1pF, ±0.25pF, ±0.5pF	45	200	0.2±0.02	
MSART042SCH9R6[WRA01	TVS042 CH9R6[C-W	25	CH	C0H	9.6 p	±0.1pF, ±0.25pF, ±0.5pF	45	200	0.2±0.02	
MSART042SCH9R7[WRA01	TVS042 CH9R7[C-W	25	CH	C0H	9.7 p	±0.1pF, ±0.25pF, ±0.5pF	45	200	0.2±0.02	
MSART042SCH9R8[WRA01	TVS042 CH9R8[C-W	25	CH	C0H	9.8 p	±0.1pF, ±0.25pF, ±0.5pF	45	200	0.2±0.02	
MSART042SCH9R9[WRA01	TVS042 CH9R9[C-W	25	CH	C0H	9.9 p	±0.1pF, ±0.25pF, ±0.5pF	45	200	0.2±0.02	
MSART042SCH100[WRA01	TVS042 CH100[C-W	25	CH	C0H	10 p	±2%, ±5%	45	200	0.2±0.02	
MSART042SCH110JWRA01	TVS042 CH110J[C-W	25	CH	C0H	11 p	±5%	40	200	0.2±0.02	
MSART042SCH120JWRA01	TVS042 CH120J[C-W	25	CH	C0H	12 p	±5%	40	200	0.2±0.02	
MSART042SCH130JWRA01	TVS042 CH130J[C-W	25	CH	C0H	13 p	±5%	40	200	0.2±0.02	
MSART042SCH150JWRA01	TVS042 CH150J[C-W	25	CH	C0H	15 p	±5%	40	200	0.2±0.02	
MSART042SCH160JWRA01	TVS042 CH160J[C-W	25	CH	C0H	16 p	±5%	40	200	0.2±0.02	
MSART042SCH180JWRA01	TVS042 CH180J[C-W	25	CH	C0H	18 p	±5%	40	200	0.2±0.02	
MSART042SCH220JWRA01	TVS042 CH220J[C-W	25	CH	C0H	22 p	±5%	30	200	0.2±0.02	

PARTS NUMBER

New part number	Old part number (for reference)	Rated voltage [V]	Temperature characteristics		Capacitance [F]	Capacitance tolerance	Q (at 1GHz) (min)	HTLT	Thickness*3 [mm]	Note
								Rated voltage x %		
MSART042SCG8R6□WRA01	TVS042 CG8R6□C-W	25	CG	C0G	8.6 p	±0.1pF, ±0.25pF, ±0.5pF	50	200	0.2±0.02	
MSART042SCG8R7□WRA01	TVS042 CG8R7□C-W	25	CG	C0G	8.7 p	±0.1pF, ±0.25pF, ±0.5pF	50	200	0.2±0.02	
MSART042SCG8R8□WRA01	TVS042 CG8R8□C-W	25	CG	C0G	8.8 p	±0.1pF, ±0.25pF, ±0.5pF	50	200	0.2±0.02	
MSART042SCG8R9□WRA01	TVS042 CG8R9□C-W	25	CG	C0G	8.9 p	±0.1pF, ±0.25pF, ±0.5pF	50	200	0.2±0.02	
MSART042SCG090□WRA01	TVS042 CG090□C-W	25	CG	C0G	9 p	±0.1pF, ±0.25pF, ±0.5pF	50	200	0.2±0.02	
MSART042SCG9R1□WRA01	TVS042 CG9R1□C-W	25	CG	C0G	9.1 p	±0.1pF, ±0.25pF, ±0.5pF	45	200	0.2±0.02	
MSART042SCG9R2□WRA01	TVS042 CG9R2□C-W	25	CG	C0G	9.2 p	±0.1pF, ±0.25pF, ±0.5pF	45	200	0.2±0.02	
MSART042SCG9R3□WRA01	TVS042 CG9R3□C-W	25	CG	C0G	9.3 p	±0.1pF, ±0.25pF, ±0.5pF	45	200	0.2±0.02	
MSART042SCG9R4□WRA01	TVS042 CG9R4□C-W	25	CG	C0G	9.4 p	±0.1pF, ±0.25pF, ±0.5pF	45	200	0.2±0.02	
MSART042SCG9R5□WRA01	TVS042 CG9R5□C-W	25	CG	C0G	9.5 p	±0.1pF, ±0.25pF, ±0.5pF	45	200	0.2±0.02	
MSART042SCG9R6□WRA01	TVS042 CG9R6□C-W	25	CG	C0G	9.6 p	±0.1pF, ±0.25pF, ±0.5pF	45	200	0.2±0.02	
MSART042SCG9R7□WRA01	TVS042 CG9R7□C-W	25	CG	C0G	9.7 p	±0.1pF, ±0.25pF, ±0.5pF	45	200	0.2±0.02	
MSART042SCG9R8□WRA01	TVS042 CG9R8□C-W	25	CG	C0G	9.8 p	±0.1pF, ±0.25pF, ±0.5pF	45	200	0.2±0.02	
MSART042SCG9R9□WRA01	TVS042 CG9R9□C-W	25	CG	C0G	9.9 p	±0.1pF, ±0.25pF, ±0.5pF	45	200	0.2±0.02	
MSART042SCG100□WRA01	TVS042 CG100□C-W	25	CG	C0G	10 p	±2%, ±5%	45	200	0.2±0.02	
MSART042SCG110JWRA01	TVS042 CG110JC-W	25	CG	C0G	11 p	±5%	40	200	0.2±0.02	
MSART042SCG120JWRA01	TVS042 CG120JC-W	25	CG	C0G	12 p	±5%	40	200	0.2±0.02	
MSART042SCG130JWRA01	TVS042 CG130JC-W	25	CG	C0G	13 p	±5%	40	200	0.2±0.02	
MSART042SCG150JWRA01	TVS042 CG150JC-W	25	CG	C0G	15 p	±5%	40	200	0.2±0.02	
MSART042SCG160JWRA01	TVS042 CG160JC-W	25	CG	C0G	16 p	±5%	40	200	0.2±0.02	
MSART042SCG180JWRA01	TVS042 CG180JC-W	25	CG	C0G	18 p	±5%	40	200	0.2±0.02	
MSART042SCG220JWRA01	TVS042 CG220JC-W	25	CG	C0G	22 p	±5%	30	200	0.2±0.02	

PARTS NUMBER

Low distortion design/Audible/Good bias Multilayer Ceramic Capacitors (CFCAP) for General Electronic Equipment for Consumer

1005TYPE

【Temperature Characteristic SD : Standard(-55~+125°C)】 0.5mm thickness

New part number	Old part number (for reference)	Rated voltage [V]	Temperature characteristics	Capacitance [F]	Capacitance tolerance [%]	tan δ [%]	HTLT	Thickness*3 [mm]	Note
							Rated voltage x %		
MSAYU105SSD391KFNA01	UMK105 SD391KV-F	50	Standard Type	390 p	±10	0.1	200	0.5±0.05	
MSAYU105SSD471KFNA01	UMK105 SD471KV-F	50	Standard Type	470 p	±10	0.1	200	0.5±0.05	
MSAYU105SSD561KFNA01	UMK105 SD561KV-F	50	Standard Type	560 p	±10	0.1	200	0.5±0.05	
MSAYT105SSD681KFNA01	TMK105 SD681KV-F	25	Standard Type	680 p	±10	0.1	200	0.5±0.05	
MSAYT105SSD821KFNA01	TMK105 SD821KV-F	25	Standard Type	820 p	±10	0.1	200	0.5±0.05	
MSAYT105SSD102KFNA01	TMK105 SD102KV-F	25	Standard Type	1000 p	±10	0.1	200	0.5±0.05	
MSAYT105SSD122KFNA01	TMK105 SD122KV-F	25	Standard Type	1200 p	±10	0.1	200	0.5±0.05	
MSAYE105SSD152KFNA01	EMK105 SD152KV-F	16	Standard Type	1500 p	±10	0.1	200	0.5±0.05	
MSAYE105SSD182KFNA01	EMK105 SD182KV-F	16	Standard Type	1800 p	±10	0.1	200	0.5±0.05	
MSAYE105SSD222KFNA01	EMK105 SD222KV-F	16	Standard Type	2200 p	±10	0.1	200	0.5±0.05	
MSAYE105SSD272KFNA01	EMK105 SD272KV-F	16	Standard Type	2700 p	±10	0.1	200	0.5±0.05	
MSAYL105SSD332KFNA01	LMK105 SD332KV-F	10	Standard Type	3300 p	±10	0.1	200	0.5±0.05	
MSAYL105SSD392KFNA01	LMK105 SD392KV-F	10	Standard Type	3900 p	±10	0.1	200	0.5±0.05	
MSAYL105SSD472KFNA01	LMK105 SD472KV-F	10	Standard Type	4700 p	±10	0.1	200	0.5±0.05	

【Temperature Characteristic SD : Standard(-55~+125°C)】 0.3mm thickness

New part number	Old part number (for reference)	Rated voltage [V]	Temperature characteristics	Capacitance [F]	Capacitance tolerance [%]	tan δ [%]	HTLT	Thickness*3 [mm]	Note
							Rated voltage x %		
MSAYL1L3YSD152KFNA01	LMK105 SD152KP-F	10	Standard Type	1500 p	±10	0.1	200	0.3±0.03	
MSAYJ1L3YSD272KFNA01	JMK105 SD272KP-F	6.3	Standard Type	2700 p	±10	0.1	200	0.3±0.03	

1608TYPE

【Temperature Characteristic SD : Standard(-55~+125°C)】 0.8mm thickness

New part number	Old part number (for reference)	Rated voltage [V]	Temperature characteristics	Capacitance [F]	Capacitance tolerance [%]	tan δ [%]	HTLT	Thickness*3 [mm]	Note
							Rated voltage x %		
MSAYU168SSD102KTNA01	UMK107 SD102KA-T	50	Standard Type	1000 p	±10	0.1	200	0.8±0.10	
MSAYU168SSD122KTNA01	UMK107 SD122KA-T	50	Standard Type	1200 p	±10	0.1	200	0.8±0.10	
MSAYU168SSD152KTNA01	UMK107 SD152KA-T	50	Standard Type	1500 p	±10	0.1	200	0.8±0.10	
MSAYU168SSD182KTNA01	UMK107 SD182KA-T	50	Standard Type	1800 p	±10	0.1	200	0.8±0.10	
MSAYU168SSD222KTNA01	UMK107 SD222KA-T	50	Standard Type	2200 p	±10	0.1	200	0.8±0.10	
MSAYU168SSD272KTNA01	UMK107 SD272KA-T	50	Standard Type	2700 p	±10	0.1	200	0.8±0.10	
MSAYU168SSD332KTNA01	UMK107 SD332KA-T	50	Standard Type	3300 p	±10	0.1	200	0.8±0.10	
MSAYT168SSD392KTNA01	TMK107 SD392KA-T	25	Standard Type	3900 p	±10	0.1	200	0.8±0.10	
MSAYT168SSD472KTNA01	TMK107 SD472KA-T	25	Standard Type	4700 p	±10	0.1	200	0.8±0.10	
MSAYE168SSD562KTNA01	EMK107 SD562KA-T	16	Standard Type	5600 p	±10	0.1	200	0.8±0.10	
MSAYE168SSD682KTNA01	EMK107 SD682KA-T	16	Standard Type	6800 p	±10	0.1	200	0.8±0.10	
MSAYE168SSD822KTNA01	EMK107 SD822KA-T	16	Standard Type	8200 p	±10	0.1	200	0.8±0.10	
MSAYE168SSD103KTNA01	EMK107 SD103KA-T	16	Standard Type	0.01 μ	±10	0.1	200	0.8±0.10	
MSAYL168SSD123KTNA01	LMK107 SD123KA-T	10	Standard Type	0.012 μ	±10	0.1	200	0.8±0.10	
MSAYL168SSD153KTNA01	LMK107 SD153KA-T	10	Standard Type	0.015 μ	±10	0.1	200	0.8±0.10	
MSAYL168SSD183KTNA01	LMK107 SD183KA-T	10	Standard Type	0.018 μ	±10	0.1	200	0.8±0.10	
MSAYL168SSD223KTNA01	LMK107 SD223KA-T	10	Standard Type	0.022 μ	±10	0.1	200	0.8±0.10	

2012TYPE

【Temperature Characteristic SD : Standard(-55~+125°C)】 1.25mm thickness

New part number	Old part number (for reference)	Rated voltage [V]	Temperature characteristics	Capacitance [F]	Capacitance tolerance [%]	tan δ [%]	HTLT	Thickness*3 [mm]	Note
							Rated voltage x %		
MSAYG21GSSD183KTNA01	GMK212 SD183KG-T	35	Standard Type	0.018 μ	±10	0.1	200	1.25±0.10	
MSAYG21GSSD223KTNA01	GMK212 SD223KG-T	35	Standard Type	0.022 μ	±10	0.1	200	1.25±0.10	
MSAYG21GSSD273KTNA01	GMK212 SD273KG-T	35	Standard Type	0.027 μ	±10	0.1	200	1.25±0.10	
MSAYL21GSSD683KTNA01	LMK212 SD683KG-T	10	Standard Type	0.068 μ	±10	0.1	200	1.25±0.10	
MSAYL21GSSD823KTNA01	LMK212 SD823KG-T	10	Standard Type	0.082 μ	±10	0.1	200	1.25±0.10	
MSAYL21GSSD104KTNA01	LMK212 SD104KG-T	10	Standard Type	0.1 μ	±10	0.1	200	1.25±0.10	

【Temperature Characteristic SD : Standard(-55~+125°C)】 0.85mm thickness

New part number	Old part number (for reference)	Rated voltage [V]	Temperature characteristics	Capacitance [F]	Capacitance tolerance [%]	tan δ [%]	HTLT	Thickness*3 [mm]	Note
							Rated voltage x %		
MSAYU219SSD392KTNA01	UMK212 SD392KD-T	50	Standard Type	3900 p	±10	0.1	200	0.85±0.10	
MSAYU219SSD472KTNA01	UMK212 SD472KD-T	50	Standard Type	4700 p	±10	0.1	200	0.85±0.10	
MSAYU219SSD562KTNA01	UMK212 SD562KD-T	50	Standard Type	5600 p	±10	0.1	200	0.85±0.10	
MSAYU219SSD682KTNA01	UMK212 SD682KD-T	50	Standard Type	6800 p	±10	0.1	200	0.85±0.10	
MSAYU219SSD822KTNA01	UMK212 SD822KD-T	50	Standard Type	8200 p	±10	0.1	200	0.85±0.10	
MSAYU219SSD103KTNA01	UMK212 SD103KD-T	50	Standard Type	0.01 μ	±10	0.1	200	0.85±0.10	
MSAYG219SSD123KTNA01	GMK212 SD123KD-T	35	Standard Type	0.012 μ	±10	0.1	200	0.85±0.10	
MSAYG219SSD153KTNA01	GMK212 SD153KD-T	35	Standard Type	0.015 μ	±10	0.1	200	0.85±0.10	
MSAYE219SSD333KTNA01	EMK212 SD333KD-T	16	Standard Type	0.033 μ	±10	0.1	200	0.85±0.10	
MSAYL219SSD473KTNA01	LMK212 SD473KD-T	10	Standard Type	0.047 μ	±10	0.1	200	0.85±0.10	

PARTS NUMBER

● 3216TYPE

【Temperature Characteristic SD : Standard (−55~+125°C)】 1.6mm thickness

New part number	Old part number (for reference)	Rated voltage [V]	Temperature characteristics	Capacitance [F]	Capacitance tolerance [%]	tan δ [%]	HLTL	Thickness*3 [mm]	Note
							Rated voltage x %		
MSAYT31LSSD823KTNA01	TMK316 SD823KL-T	25	Standard Type	0.082 μ	±10	0.1	200	1.6±0.20	
MSAYT31LSSD104KTNA01	TMK316 SD104KL-T	25	Standard Type	0.1 μ	±10	0.1	200	1.6±0.20	

【Temperature Characteristic SD : Standard (−55~+125°C)】 1.15mm thickness

New part number	Old part number (for reference)	Rated voltage [V]	Temperature characteristics	Capacitance [F]	Capacitance tolerance [%]	tan δ [%]	HLTL	Thickness*3 [mm]	Note
							Rated voltage x %		
MSAYG31QHSD333KTNA01	GMK316 SD333KF-T	35	Standard Type	0.033 μ	±10	0.1	200	1.15±0.10	
MSAYG31QHSD393KTNA01	GMK316 SD393KF-T	35	Standard Type	0.039 μ	±10	0.1	200	1.15±0.10	
MSAYT31QHSD473KTNA01	TMK316 SD473KF-T	25	Standard Type	0.047 μ	±10	0.1	200	1.15±0.10	
MSAYT31QHSD563KTNA01	TMK316 SD563KF-T	25	Standard Type	0.056 μ	±10	0.1	200	1.15±0.10	
MSAYT31QHSD683KTNA01	TMK316 SD683KF-T	25	Standard Type	0.068 μ	±10	0.1	200	1.15±0.10	

PARTS NUMBER

Low distortion design/Audible/Good bias Multilayer Ceramic Capacitors (CF LD) for General Electronic Equipment for Consumer

1608TYPE

【Temperature Characteristic LD : X5R (−55~+85°C)】 0.8mm thickness

New part number	Old part number (for reference)	Rated voltage [V]	Temperature characteristics	Capacitance [F]	Capacitance tolerance [%]	tan δ [%]	HTLT	Thickness ^{*3} [mm]	Note
							Rated voltage x %		
MSAYU168BLD224□TNA01	UMK107BLD224□A-T	50	X5R	0.22 μ	±10, ±20	10	150	0.8+0.20/-0	
MSAYT168BLD474□TNA01	TMK107BLD474□A-T	25	X5R	0.47 μ	±10, ±20	10	150	0.8+0.20/-0	
MSAYT168BLD105□TNA01	TMK107BLD105□A-T	25	X5R	1 μ	±10, ±20	10	150	0.8+0.20/-0	

2012TYPE

【Temperature Characteristic LD : X5R (−55~+85°C)】 1.25mm thickness

New part number	Old part number (for reference)	Rated voltage [V]	Temperature characteristics	Capacitance [F]	Capacitance tolerance [%]	tan δ [%]	HTLT	Thickness ^{*3} [mm]	Note
							Rated voltage x %		
MSAYG21GSLD105□TNA01	GMK212 LD105□G-T	35	X5R	1 μ	±10, ±20	10	150	1.25±0.10	
MSAYG21GBLD225□TNA01	GMK212BLD225□G-T	35	X5R	2.2 μ	±10, ±20	10	150	1.25+0.20/-0	

3216TYPE

【Temperature Characteristic LD : X5R (−55~+85°C)】 1.6mm thickness

New part number	Old part number (for reference)	Rated voltage [V]	Temperature characteristics	Capacitance [F]	Capacitance tolerance [%]	tan δ [%]	HTLT	Thickness ^{*3} [mm]	Note
							Rated voltage x %		
MSAYU31LSLD105□TNA01	UMK316 LD105□L-T	50	X5R	1 μ	±10, ±20	10	150	1.6±0.20	
MSAYG31LBLD475□TNA01	GMK316BLD475□L-T	35	X5R	4.7 μ	±10, ±20	10	150	1.6±0.30	
MSAYT31LBLD106□TNA01	TMK316BLD106□L-T	25	X5R	10 μ	±10, ±20	10	150	1.6±0.30	

3225TYPE

【Temperature Characteristic LD : X5R (−55~+85°C)】 1.9mm thickness

New part number	Old part number (for reference)	Rated voltage [V]	Temperature characteristics	Capacitance [F]	Capacitance tolerance [%]	tan δ [%]	HTLT	Thickness ^{*3} [mm]	Note
							Rated voltage x %		
MSAYU32NSLD105□TNA01	UMK325 LD105□N-T	50	X5R	1 μ	±10, ±20	10	200	1.9±0.20	

【Temperature Characteristic LD : X5R (−55~+85°C)】 2.5mm thickness

New part number	Old part number (for reference)	Rated voltage [V]	Temperature characteristics	Capacitance [F]	Capacitance tolerance [%]	tan δ [%]	HTLT	Thickness ^{*3} [mm]	Note
							Rated voltage x %		
MSAYU32MSLD475□PNA01	UMK325 LD475□M-P	50	X5R	4.7 μ	±10, ±20	10	200	2.5±0.20	

PARTS NUMBER

Medium-High Voltage Multilayer Ceramic Capacitors for General Electronic Equipment for Consumer

1005TYPE

【Temperature Characteristic B7 : X7R (−55~+125°C)】 0.5mm thickness

New part number	Old part number (for reference)	Rated voltage [V]	Temperature characteristics		Capacitance [F]	Capacitance tolerance [%]	tan δ [%]	HTLT	Thickness ^{*3} [mm]	Note
			Rated voltage x %							
MSASH105SB7221□FNA01	HMK105 B7221□V-F	100		X7R	220 p	±10, ±20	2.5	200	0.5±0.05	
MSASH105SB7331□FNA01	HMK105 B7331□V-F	100		X7R	330 p	±10, ±20	2.5	200	0.5±0.05	
MSASH105SB7471□FNA01	HMK105 B7471□V-F	100		X7R	470 p	±10, ±20	2.5	200	0.5±0.05	
MSASH105SB7681□FNA01	HMK105 B7681□V-F	100		X7R	680 p	±10, ±20	2.5	200	0.5±0.05	
MSASH105SB7102□FNA01	HMK105 B7102□V-F	100		X7R	1000 p	±10, ±20	2.5	200	0.5±0.05	
MSASH105SB7152□FNA01	HMK105 B7152□V-F	100		X7R	1500 p	±10, ±20	2.5	200	0.5±0.05	
MSASH105SB7222□FNA01	HMK105 B7222□V-F	100		X7R	2200 p	±10, ±20	2.5	200	0.5±0.05	
MSASH105SB7332□FNA01	HMK105 B7332□V-F	100		X7R	3300 p	±10, ±20	2.5	200	0.5±0.05	
MSASH105SB7472□FNA01	HMK105 B7472□V-F	100		X7R	4700 p	±10, ±20	2.5	200	0.5±0.05	

【Temperature Characteristic CΔ : CΔ/C0Δ (−55~+125°C)】 0.5mm thickness

New part number	Old part number (for reference)	Rated voltage [V]	Temperature characteristics		Capacitance [F]	Capacitance tolerance	Q (at 1MHz) (min)	HTLT	Thickness ^{*3} [mm]	Note
			Rated voltage x %							
MSASH105SCH080DFNA01	HMK105 CH080DV-F	100	CH	C0H	8 p	±0.5pF	560	200	0.5±0.05	
MSASH105SCH090DFNA01	HMK105 CH090DV-F	100	CH	C0H	9 p	±0.5pF	580	200	0.5±0.05	
MSASH105SCH100DFNA01	HMK105 CH100DV-F	100	CH	C0H	10 p	±0.5pF	600	200	0.5±0.05	
MSASH105SCH120JFNA01	HMK105 CH120JV-F	100	CH	C0H	12 p	±5%	640	200	0.5±0.05	
MSASH105SCH150JFNA01	HMK105 CH150JV-F	100	CH	C0H	15 p	±5%	700	200	0.5±0.05	
MSASH105SCH180JFNA01	HMK105 CH180JV-F	100	CH	C0H	18 p	±5%	760	200	0.5±0.05	
MSASH105SCH220JFNA01	HMK105 CH220JV-F	100	CH	C0H	22 p	±5%	840	200	0.5±0.05	
MSASH105SCH240JFNA01	HMK105 CH240JV-F	100	CH	C0H	24 p	±5%	880	200	0.5±0.05	
MSASH105SCH270JFNA01	HMK105 CH270JV-F	100	CH	C0H	27 p	±5%	940	200	0.5±0.05	
MSASH105SCH330JFNA01	HMK105 CH330JV-F	100	CH	C0H	33 p	±5%	1000	200	0.5±0.05	
MSASH105SCH390JFNA01	HMK105 CH390JV-F	100	CH	C0H	39 p	±5%	1000	200	0.5±0.05	
MSASH105SCH470JFNA01	HMK105 CH470JV-F	100	CH	C0H	47 p	±5%	1000	200	0.5±0.05	
MSASH105SCH560JFNA01	HMK105 CH560JV-F	100	CH	C0H	56 p	±5%	1000	200	0.5±0.05	
MSASH105SCH680JFNA01	HMK105 CH680JV-F	100	CH	C0H	68 p	±5%	1000	200	0.5±0.05	
MSASH105SCH820JFNA01	HMK105 CH820JV-F	100	CH	C0H	82 p	±5%	1000	200	0.5±0.05	
MSASH105SCH101JFNA01	HMK105 CH101JV-F	100	CH	C0H	100 p	±5%	1000	200	0.5±0.05	
MSASH105SCG080DFNA01	HMK105 CG080DV-F	100	CG	C0G	8 p	±0.5pF	560	200	0.5±0.05	
MSASH105SCG090DFNA01	HMK105 CG090DV-F	100	CG	C0G	9 p	±0.5pF	580	200	0.5±0.05	
MSASH105SCG100DFNA01	HMK105 CG100DV-F	100	CG	C0G	10 p	±0.5pF	600	200	0.5±0.05	
MSASH105SCG120JFNA01	HMK105 CG120JV-F	100	CG	C0G	12 p	±5%	640	200	0.5±0.05	
MSASH105SCG150JFNA01	HMK105 CG150JV-F	100	CG	C0G	15 p	±5%	700	200	0.5±0.05	
MSASH105SCG180JFNA01	HMK105 CG180JV-F	100	CG	C0G	18 p	±5%	760	200	0.5±0.05	
MSASH105SCG220JFNA01	HMK105 CG220JV-F	100	CG	C0G	22 p	±5%	840	200	0.5±0.05	
MSASH105SCG240JFNA01	HMK105 CG240JV-F	100	CG	C0G	24 p	±5%	880	200	0.5±0.05	
MSASH105SCG270JFNA01	HMK105 CG270JV-F	100	CG	C0G	27 p	±5%	940	200	0.5±0.05	
MSASH105SCG330JFNA01	HMK105 CG330JV-F	100	CG	C0G	33 p	±5%	1000	200	0.5±0.05	
MSASH105SCG390JFNA01	HMK105 CG390JV-F	100	CG	C0G	39 p	±5%	1000	200	0.5±0.05	
MSASH105SCG470JFNA01	HMK105 CG470JV-F	100	CG	C0G	47 p	±5%	1000	200	0.5±0.05	
MSASH105SCG560JFNA01	HMK105 CG560JV-F	100	CG	C0G	56 p	±5%	1000	200	0.5±0.05	
MSASH105SCG680JFNA01	HMK105 CG680JV-F	100	CG	C0G	68 p	±5%	1000	200	0.5±0.05	
MSASH105SCG820JFNA01	HMK105 CG820JV-F	100	CG	C0G	82 p	±5%	1000	200	0.5±0.05	
MSASH105SCG101JFNA01	HMK105 CG101JV-F	100	CG	C0G	100 p	±5%	1000	200	0.5±0.05	

1608TYPE

【Temperature Characteristic B5(BJ) : B (−25~+85°C)/X5R (−55~+85°C)】 0.8mm thickness

New part number	Old part number (for reference)	Rated voltage [V]	Temperature characteristics		Capacitance [F]	Capacitance tolerance [%]	tan δ [%]	HTLT	Thickness ^{*3} [mm]	Note
			Rated voltage x %							
MSASH168SB5102□TNA01	HMK107 BJ102□A-T	100	B	X5R ⁺¹	1000 p	±10, ±20	3.5	200	0.8±0.10	
MSASH168SB5152□TNA01	HMK107 BJ152□A-T	100	B	X5R ⁺¹	1500 p	±10, ±20	3.5	200	0.8±0.10	
MSASH168SB5222□TNA01	HMK107 BJ222□A-T	100	B	X5R ⁺¹	2200 p	±10, ±20	3.5	200	0.8±0.10	
MSASH168SB5332□TNA01	HMK107 BJ332□A-T	100	B	X5R ⁺¹	3300 p	±10, ±20	3.5	200	0.8±0.10	
MSASH168SB5472□TNA01	HMK107 BJ472□A-T	100	B	X5R ⁺¹	4700 p	±10, ±20	3.5	200	0.8±0.10	
MSASH168SB5682□TNA01	HMK107 BJ682□A-T	100	B	X5R ⁺¹	6800 p	±10, ±20	3.5	200	0.8±0.10	
MSASH168SB5103□TNA01	HMK107 BJ103□A-T	100	B	X5R ⁺¹	0.01 μ	±10, ±20	3.5	200	0.8±0.10	
MSASH168SB5153□TNA01	HMK107 BJ153□A-T	100	B	X5R ⁺¹	0.015 μ	±10, ±20	3.5	200	0.8±0.10	
MSASH168SB5223□TNA01	HMK107 BJ223□A-T	100	B	X5R ⁺¹	0.022 μ	±10, ±20	3.5	200	0.8±0.10	
MSASH168SB5333□TNA01	HMK107 BJ333□A-T	100	B	X5R ⁺¹	0.033 μ	±10, ±20	3.5	200	0.8±0.10	
MSASH168SB5473□TNA01	HMK107 BJ473□A-T	100	B	X5R ⁺¹	0.047 μ	±10, ±20	3.5	200	0.8±0.10	
MSASH168SB5104□TNA01	HMK107 BJ104□A-T	100	B	X5R ⁺¹	0.1 μ	±10, ±20	3.5	200	0.8±0.10	
MSASH168SB5224□TCA01	HMK107 BJ224□A-TE	100	B	X5R ⁺¹	0.22 μ	±10, ±20	3.5	150	0.8±0.10	

【Temperature Characteristic C7 : X7S (−55~+125°C)】 0.8mm thickness

New part number	Old part number (for reference)	Rated voltage [V]	Temperature characteristics		Capacitance [F]	Capacitance tolerance [%]	tan δ [%]	HTLT	Thickness ^{*3} [mm]	Note
			Rated voltage x %							
MSASH168SC7224□TCA01	HMK107 C7224□A-TE	100		X7S	0.22 μ	±10, ±20	3.5	150	0.8±0.10	

PARTS NUMBER

【Temperature Characteristic B7 : X7R (−55~+125°C)】 0.8mm thickness

New part number	Old part number (for reference)	Rated voltage [V]	Temperature characteristics		Capacitance [F]	Capacitance tolerance [%]	tan δ [%]	HTLT	Thickness ^{*3} [mm]	Note
								Rated voltage x %		
MSASH168SB7102□TNA01	HMK107 B7102□A-T	100		X7R	1000 p	±10, ±20	3.5	200	0.8±0.10	
MSASH168SB7152□TNA01	HMK107 B7152□A-T	100		X7R	1500 p	±10, ±20	3.5	200	0.8±0.10	
MSASH168SB7222□TNA01	HMK107 B7222□A-T	100		X7R	2200 p	±10, ±20	3.5	200	0.8±0.10	
MSASH168SB7332□TNA01	HMK107 B7332□A-T	100		X7R	3300 p	±10, ±20	3.5	200	0.8±0.10	
MSASH168SB7472□TNA01	HMK107 B7472□A-T	100		X7R	4700 p	±10, ±20	3.5	200	0.8±0.10	
MSASH168SB7682□TNA01	HMK107 B7682□A-T	100		X7R	6800 p	±10, ±20	3.5	200	0.8±0.10	
MSASH168SB7103□TNA01	HMK107 B7103□A-T	100		X7R	0.01 μ	±10, ±20	3.5	200	0.8±0.10	
MSASH168SB7153□TNA01	HMK107 B7153□A-T	100		X7R	0.015 μ	±10, ±20	3.5	200	0.8±0.10	
MSASH168SB7223□TNA01	HMK107 B7223□A-T	100		X7R	0.022 μ	±10, ±20	3.5	200	0.8±0.10	
MSASH168SB7333□TNA01	HMK107 B7333□A-T	100		X7R	0.033 μ	±10, ±20	3.5	200	0.8±0.10	
MSASH168SB7473□TNA01	HMK107 B7473□A-T	100		X7R	0.047 μ	±10, ±20	3.5	200	0.8±0.10	
MSASH168SB7104□TNA01	HMK107 B7104□A-T	100		X7R	0.1 μ	±10, ±20	3.5	200	0.8±0.10	

【Temperature Characteristic SD : Standard (−55~+125°C)】 0.8mm thickness

New part number	Old part number (for reference)	Rated voltage [V]	Temperature characteristics		Capacitance [F]	Capacitance tolerance [%]	tan δ [%]	HTLT	Thickness ^{*3} [mm]	Note
								Rated voltage x %		
MSASH168SSD101KTNA01	HMK107 SD101KA-T	100		Standard Type	100 p	±10	0.1	200	0.8±0.10	
MSASH168SSD121KTNA01	HMK107 SD121KA-T	100		Standard Type	120 p	±10	0.1	200	0.8±0.10	
MSASH168SSD151KTNA01	HMK107 SD151KA-T	100		Standard Type	150 p	±10	0.1	200	0.8±0.10	
MSASH168SSD181KTNA01	HMK107 SD181KA-T	100		Standard Type	180 p	±10	0.1	200	0.8±0.10	
MSASH168SSD221KTNA01	HMK107 SD221KA-T	100		Standard Type	220 p	±10	0.1	200	0.8±0.10	
MSASH168SSD271KTNA01	HMK107 SD271KA-T	100		Standard Type	270 p	±10	0.1	200	0.8±0.10	
MSASH168SSD331KTNA01	HMK107 SD331KA-T	100		Standard Type	330 p	±10	0.1	200	0.8±0.10	
MSASH168SSD391KTNA01	HMK107 SD391KA-T	100		Standard Type	390 p	±10	0.1	200	0.8±0.10	
MSASH168SSD471KTNA01	HMK107 SD471KA-T	100		Standard Type	470 p	±10	0.1	200	0.8±0.10	
MSASH168SSD561KTNA01	HMK107 SD561KA-T	100		Standard Type	560 p	±10	0.1	200	0.8±0.10	
MSASH168SSD681KTNA01	HMK107 SD681KA-T	100		Standard Type	680 p	±10	0.1	200	0.8±0.10	
MSASH168SSD821KTNA01	HMK107 SD821KA-T	100		Standard Type	820 p	±10	0.1	200	0.8±0.10	
MSASH168SSD102KTNA01	HMK107 SD102KA-T	100		Standard Type	1000 p	±10	0.1	200	0.8±0.10	

2012TYPE

【Temperature Characteristic B5(BJ) : B (−25~+85°C)/X5R (−55~+85°C)】 1.25mm thickness

New part number	Old part number (for reference)	Rated voltage [V]	Temperature characteristics		Capacitance [F]	Capacitance tolerance [%]	tan δ [%]	HTLT	Thickness ^{*3} [mm]	Note
								Rated voltage x %		
MSASH21GSB5103□TNA01	HMK212 BJ103□G-T	100	B	X5R ^{*1}	0.01 μ	±10, ±20	3.5	200	1.25±0.10	
MSASH21GSB5153□TNA01	HMK212 BJ153□G-T	100	B	X5R ^{*1}	0.015 μ	±10, ±20	3.5	200	1.25±0.10	
MSASH21GSB5223□TNA01	HMK212 BJ223□G-T	100	B	X5R ^{*1}	0.022 μ	±10, ±20	3.5	200	1.25±0.10	
MSASH21GSB5333□TNA01	HMK212 BJ333□G-T	100	B	X5R ^{*1}	0.033 μ	±10, ±20	3.5	200	1.25±0.10	
MSASH21GSB5473□TNA01	HMK212 BJ473□G-T	100	B	X5R ^{*1}	0.047 μ	±10, ±20	3.5	200	1.25±0.10	
MSASH21GSB5683□TNA01	HMK212 BJ683□G-T	100	B	X5R ^{*1}	0.068 μ	±10, ±20	3.5	200	1.25±0.10	
MSASH21GSB5104□TNA01	HMK212 BJ104□G-T	100	B	X5R ^{*1}	0.1 μ	±10, ±20	3.5	200	1.25±0.10	
MSASH21GSB5224□TNA01	HMK212 BJ224□G-T	100	B	X5R ^{*1}	0.22 μ	±10, ±20	3.5	200	1.25±0.10	
MSASH21GSB5474□TCA01	HMK212 BJ474□G-TE	100	B	X5R ^{*1}	0.47 μ	±10, ±20	3.5	150	1.25±0.10	
MSASH21GBB5105□TCA01	HMK212BBJ105□G-TE	100	B	X5R ^{*1}	1 μ	±10, ±20	3.5	150	1.25+0.20/-0	
MSASQ21GSB5472□TNA01	QMK212 BJ472□G-T	250	B	X5R ^{*1}	4700 p	±10, ±20	2.5	150	1.25±0.10	
MSASQ21GSB5682□TNA01	QMK212 BJ682□G-T	250	B	X5R ^{*1}	6800 p	±10, ±20	2.5	150	1.25±0.10	
MSASQ21GSB5103□TNA01	QMK212 BJ103□G-T	250	B	X5R ^{*1}	0.01 μ	±10, ±20	2.5	150	1.25±0.10	
MSASQ21GSB5153□TNA01	QMK212 BJ153□G-T	250	B	X5R ^{*1}	0.015 μ	±10, ±20	2.5	150	1.25±0.10	
MSASQ21GSB5223□TNA01	QMK212 BJ223□G-T	250	B	X5R ^{*1}	0.022 μ	±10, ±20	2.5	150	1.25±0.10	

【Temperature Characteristic B5(BJ) : B (−25~+85°C)/X5R (−55~+85°C)】 0.85mm thickness

New part number	Old part number (for reference)	Rated voltage [V]	Temperature characteristics		Capacitance [F]	Capacitance tolerance [%]	tan δ [%]	HTLT	Thickness ^{*3} [mm]	Note
								Rated voltage x %		
MSASQ219SB5102□TNA01	QMK212 BJ102□D-T	250	B	X5R ^{*1}	1000 p	±10, ±20	2.5	150	0.85±0.10	
MSASQ219SB5152□TNA01	QMK212 BJ152□D-T	250	B	X5R ^{*1}	1500 p	±10, ±20	2.5	150	0.85±0.10	
MSASQ219SB5222□TNA01	QMK212 BJ222□D-T	250	B	X5R ^{*1}	2200 p	±10, ±20	2.5	150	0.85±0.10	
MSASQ219SB5332□TNA01	QMK212 BJ332□D-T	250	B	X5R ^{*1}	3300 p	±10, ±20	2.5	150	0.85±0.10	

【Temperature Characteristic C7 : X7S (−55~+125°C)】 1.25mm thickness

New part number	Old part number (for reference)	Rated voltage [V]	Temperature characteristics		Capacitance [F]	Capacitance tolerance [%]	tan δ [%]	HTLT	Thickness ^{*3} [mm]	Note
								Rated voltage x %		
MSASH21GSC7474□TCA01	HMK212 C7474□G-TE	100		X7S	0.47 μ	±10, ±20	3.5	150	1.25±0.10	
MSASH21GBC7105□TCA01	HMK212BC7105□G-TE	100		X7S	1 μ	±10, ±20	3.5	150	1.25+0.20/-0	

PARTS NUMBER

【Temperature Characteristic C7 : X7S (−55~+125°C)】 1.6mm thickness

New part number	Old part number (for reference)	Rated voltage [V]	Temperature characteristics	Capacitance [F]	Capacitance tolerance [%]	tan δ [%]	HTLT	Thickness ^{*3} [mm]	Note
							Rated voltage x %		
MSASH31LAC7225□TCA01	HMK316AC7225□L-TE	100	X7S	2.2 μ	±10, ±20	3.5	150	1.6±0.20	

【Temperature Characteristic B7 : X7R (−55~+125°C)】 1.6mm thickness

New part number	Old part number (for reference)	Rated voltage [V]	Temperature characteristics	Capacitance [F]	Capacitance tolerance [%]	tan δ [%]	HTLT	Thickness ^{*3} [mm]	Note
							Rated voltage x %		
MSASH31LSB7473□TNA01	HMK316 B7473□L-T	100	X7R	0.047 μ	±10, ±20	3.5	200	1.6±0.20	
MSASH31LSB7683□TNA01	HMK316 B7683□L-T	100	X7R	0.068 μ	±10, ±20	3.5	200	1.6±0.20	
MSASH31LSB7104□TNA01	HMK316 B7104□L-T	100	X7R	0.1 μ	±10, ±20	3.5	200	1.6±0.20	
MSASH31LSB7154□TNA01	HMK316 B7154□L-T	100	X7R	0.15 μ	±10, ±20	3.5	200	1.6±0.20	
MSASH31LSB7224□TNA01	HMK316 B7224□L-T	100	X7R	0.22 μ	±10, ±20	3.5	200	1.6±0.20	
MSASH31LSB7334□TNA01	HMK316 B7334□L-T	100	X7R	0.33 μ	±10, ±20	3.5	200	1.6±0.20	
MSASH31LSB7474□TNA01	HMK316 B7474□L-T	100	X7R	0.47 μ	±10, ±20	3.5	200	1.6±0.20	
MSASH31LSB7105□TNA01	HMK316 B7105□L-T	100	X7R	1 μ	±10, ±20	3.5	200	1.6±0.20	
MSASQ31LSB7333□TNA01	QMK316 B7333□L-T	250	X7R	0.033 μ	±10, ±20	2.5	150	1.6±0.20	
MSASQ31LSB7473□TNA01	QMK316 B7473□L-T	250	X7R	0.047 μ	±10, ±20	2.5	150	1.6±0.20	
MSASQ31LSB7683□TNA01	QMK316 B7683□L-T	250	X7R	0.068 μ	±10, ±20	2.5	150	1.6±0.20	
MSASQ31LSB7104□TNA01	QMK316 B7104□L-T	250	X7R	0.1 μ	±10, ±20	2.5	150	1.6±0.20	
MSASS31LSB7153□TNA01	SMK316 B7153□L-T	630	X7R	0.015 μ	±10, ±20	2.5	120	1.6±0.20	
MSASS31LSB7223□TNA01	SMK316 B7223□L-T	630	X7R	0.022 μ	±10, ±20	2.5	120	1.6±0.20	
MSASS31LAB7333□TNA01	SMK316AB7333□L-T	630	X7R	0.033 μ	±10, ±20	2.5	120	1.6±0.20	
MSASS31LAB7473□TNA01	SMK316AB7473□L-T	630	X7R	0.047 μ	±10, ±20	2.5	120	1.6±0.20	

【Temperature Characteristic B7 : X7R (−55~+125°C)】 1.15mm thickness

New part number	Old part number (for reference)	Rated voltage [V]	Temperature characteristics	Capacitance [F]	Capacitance tolerance [%]	tan δ [%]	HTLT	Thickness ^{*3} [mm]	Note
							Rated voltage x %		
MSASS31QHB7102□TNA01	SMK316 B7102□F-T	630	X7R	1000 p	±10, ±20	2.5	120	1.15±0.10	
MSASS31QHB7152□TNA01	SMK316 B7152□F-T	630	X7R	1500 p	±10, ±20	2.5	120	1.15±0.10	
MSASS31QHB7222□TNA01	SMK316 B7222□F-T	630	X7R	2200 p	±10, ±20	2.5	120	1.15±0.10	
MSASS31QHB7332□TNA01	SMK316 B7332□F-T	630	X7R	3300 p	±10, ±20	2.5	120	1.15±0.10	
MSASS31QHB7472□TNA01	SMK316 B7472□F-T	630	X7R	4700 p	±10, ±20	2.5	120	1.15±0.10	
MSASS31QHB7682□TNA01	SMK316 B7682□F-T	630	X7R	6800 p	±10, ±20	2.5	120	1.15±0.10	
MSASS31QHB7103□TNA01	SMK316 B7103□F-T	630	X7R	0.01 μ	±10, ±20	2.5	120	1.15±0.10	

【Temperature Characteristic SD : Standard (−55~+125°C)】 1.6mm thickness

New part number	Old part number (for reference)	Rated voltage [V]	Temperature characteristics	Capacitance [F]	Capacitance tolerance [%]	tan δ [%]	HTLT	Thickness ^{*3} [mm]	Note
							Rated voltage x %		
MSASH31LSSD223KTNA01	HMK316 SD223KL-T	100	Standard Type	0.022 μ	±10	0.1	200	1.6±0.20	
MSASQ31LSSD103KTNA01	QMK316 SD103KL-T	250	Standard Type	0.01 μ	±10	0.1	150	1.6±0.20	

● 3225TYPE

【Temperature Characteristic B5(BJ) : B (−25~+85°C)/X5R (−55~+85°C)】 2.5mm thickness

New part number	Old part number (for reference)	Rated voltage [V]	Temperature characteristics	Capacitance [F]	Capacitance tolerance [%]	tan δ [%]	HTLT	Thickness ^{*3} [mm]	Note
							Rated voltage x %		
MSASH32MSB5225□PNA01	HMK325 BJ225□M-P	100	B X5R ^{*1}	2.2 μ	±10, ±20	3.5	200	2.5±0.20	
MSASH32MSB5475□PCA01	HMK325 BJ475□M-PE	100	B X5R ^{*1}	4.7 μ	±10, ±20	3.5	150	2.5±0.20	

【Temperature Characteristic B5(BJ) : B (−25~+85°C)/X5R (−55~+85°C)】 1.9mm thickness

New part number	Old part number (for reference)	Rated voltage [V]	Temperature characteristics	Capacitance [F]	Capacitance tolerance [%]	tan δ [%]	HTLT	Thickness ^{*3} [mm]	Note
							Rated voltage x %		
MSASH32NSB5154□TNA01	HMK325 BJ154□N-T	100	B X5R ^{*1}	0.15 μ	±10, ±20	3.5	200	1.9±0.20	
MSASH32NSB5224□TNA01	HMK325 BJ224□N-T	100	B X5R ^{*1}	0.22 μ	±10, ±20	3.5	200	1.9±0.20	
MSASH32NSB5334□TNA01	HMK325 BJ334□N-T	100	B X5R ^{*1}	0.33 μ	±10, ±20	3.5	200	1.9±0.20	
MSASH32NSB5474□TNA01	HMK325 BJ474□N-T	100	B X5R ^{*1}	0.47 μ	±10, ±20	3.5	200	1.9±0.20	
MSASH32NSB5684□TNA01	HMK325 BJ684□N-T	100	B X5R ^{*1}	0.68 μ	±10, ±20	3.5	200	1.9±0.20	
MSASH32NSB5105□TNA01	HMK325 BJ105□N-T	100	B X5R ^{*1}	1 μ	±10, ±20	3.5	200	1.9±0.20	
MSASH32NSB5475□TCA01	HMK325 BJ475□N-TE	100	B X5R ^{*1}	4.7 μ	±10, ±20	3.5	150	1.9±0.20	
MSASQ32NSB5473□TNA01	QMK325 BJ473□N-T	250	B X5R ^{*1}	0.047 μ	±10, ±20	2.5	150	1.9±0.20	
MSASQ32NSB5104□TNA01	QMK325 BJ104□N-T	250	B X5R ^{*1}	0.1 μ	±10, ±20	2.5	150	1.9±0.20	
MSASQ32NSB5154□TNA01	QMK325 BJ154□N-T	250	B X5R ^{*1}	0.15 μ	±10, ±20	2.5	150	1.9±0.20	
MSASQ32NSB5224□TNA01	QMK325 BJ224□N-T	250	B X5R ^{*1}	0.22 μ	±10, ±20	2.5	150	1.9±0.20	
MSASS32NSB5223□TNA01	SMK325 BJ223□N-T	630	B X5R ^{*1}	0.022 μ	±10, ±20	2.5	120	1.9±0.20	
MSASS32NSB5333□TNA01	SMK325 BJ333□N-T	630	B X5R ^{*1}	0.033 μ	±10, ±20	2.5	120	1.9±0.20	
MSASS32NSB5473□TNA01	SMK325 BJ473□N-T	630	B X5R ^{*1}	0.047 μ	±10, ±20	2.5	120	1.9±0.20	

【Temperature Characteristic B5(BJ) : B (−25~+85°C)/X5R (−55~+85°C)】 1.15mm thickness

New part number	Old part number (for reference)	Rated voltage [V]	Temperature characteristics	Capacitance [F]	Capacitance tolerance [%]	tan δ [%]	HTLT	Thickness ^{*3} [mm]	Note
							Rated voltage x %		
MSASH32QJB5104□TNA01	HMK325 BJ104□F-T	100	B X5R ^{*1}	0.1 μ	±10, ±20	3.5	200	1.15±0.10	

【Temperature Characteristic B7 : X7R (−55~+125°C)】 2.5mm thickness

New part number	Old part number (for reference)	Rated voltage [V]	Temperature characteristics	Capacitance [F]	Capacitance tolerance [%]	tan δ [%]	HTLT	Thickness ^{*3} [mm]	Note
							Rated voltage x %		
MSASH32MSB7225□PNA01	HMK325 B7225□M-P	100	X7R	2.2 μ	±10, ±20	3.5	200	2.5±0.20	

PARTS NUMBER

【Temperature Characteristic B7 : X7R (−55~+125°C)】 1.9mm thickness

New part number	Old part number (for reference)	Rated voltage [V]	Temperature characteristics		Capacitance [F]	Capacitance tolerance [%]	tan δ [%]	HTLT	Thickness ^{*3} [mm]	Note
								Rated voltage x %		
MSASH32NSB7154□TNA01	HMK325 B7154□N-T	100		X7R	0.15 μ	±10, ±20	3.5	200	1.9±0.20	
MSASH32NSB7224□TNA01	HMK325 B7224□N-T	100		X7R	0.22 μ	±10, ±20	3.5	200	1.9±0.20	
MSASH32NSB7334□TNA01	HMK325 B7334□N-T	100		X7R	0.33 μ	±10, ±20	3.5	200	1.9±0.20	
MSASH32NSB7474□TNA01	HMK325 B7474□N-T	100		X7R	0.47 μ	±10, ±20	3.5	200	1.9±0.20	
MSASH32NSB7684□TNA01	HMK325 B7684□N-T	100		X7R	0.68 μ	±10, ±20	3.5	200	1.9±0.20	
MSASH32NSB7105□TNA01	HMK325 B7105□N-T	100		X7R	1 μ	±10, ±20	3.5	200	1.9±0.20	
MSASQ32NSB7473□TNA01	QMK325 B7473□N-T	250		X7R	0.047 μ	±10, ±20	2.5	150	1.9±0.20	
MSASQ32NSB7104□TNA01	QMK325 B7104□N-T	250		X7R	0.1 μ	±10, ±20	2.5	150	1.9±0.20	
MSASQ32NSB7154□TNA01	QMK325 B7154□N-T	250		X7R	0.15 μ	±10, ±20	2.5	150	1.9±0.20	
MSASQ32NSB7224□TNA01	QMK325 B7224□N-T	250		X7R	0.22 μ	±10, ±20	2.5	150	1.9±0.20	
MSASS32NSB7223□TNA01	SMK325 B7223□N-T	630		X7R	0.022 μ	±10, ±20	2.5	120	1.9±0.20	
MSASS32NSB7333□TNA01	SMK325 B7333□N-T	630		X7R	0.033 μ	±10, ±20	2.5	120	1.9±0.20	
MSASS32NSB7473□TNA01	SMK325 B7473□N-T	630		X7R	0.047 μ	±10, ±20	2.5	120	1.9±0.20	

【Temperature Characteristic C7 : X7S (−55~+125°C)】 2.5mm thickness

New part number	Old part number (for reference)	Rated voltage [V]	Temperature characteristics		Capacitance [F]	Capacitance tolerance [%]	tan δ [%]	HTLT	Thickness ^{*3} [mm]	Note
								Rated voltage x %		
MSASH32MSC7475□PCA01	HMK325 C7475□M-PE	100		X7S	4.7 μ	±10, ±20	3.5	150	2.5±0.20	

【Temperature Characteristic C7 : X7S (−55~+125°C)】 1.9mm thickness

New part number	Old part number (for reference)	Rated voltage [V]	Temperature characteristics		Capacitance [F]	Capacitance tolerance [%]	tan δ [%]	HTLT	Thickness ^{*3} [mm]	Note
								Rated voltage x %		
MSASH32NSC7475□TCA01	HMK325 C7475□N-TE	100		X7S	4.7 μ	±10, ±20	3.5	150	1.9±0.20	

【Temperature Characteristic B7 : X7R (−55~+125°C)】 1.15mm thickness

New part number	Old part number (for reference)	Rated voltage [V]	Temperature characteristics		Capacitance [F]	Capacitance tolerance [%]	tan δ [%]	HTLT	Thickness ^{*3} [mm]	Note
								Rated voltage x %		
MSASH32QJB7104□TNA01	HMK325 B7104□F-T	100		X7R	0.1 μ	±10, ±20	3.5	200	1.15±0.10	

4532TYPE

【Temperature Characteristic B5(BJ) : B (−25~+85°C)/X5R (−55~+85°C)】 2.5mm thickness

New part number	Old part number (for reference)	Rated voltage [V]	Temperature characteristics		Capacitance [F]	Capacitance tolerance [%]	tan δ [%]	HTLT	Thickness ^{*3} [mm]	Note
								Rated voltage x %		
MSASH45MSB5474□TNA01	HMK432 BJ474□M-T	100	B	X5R ^{*1}	0.47 μ	±10, ±20	3.5	200	2.5±0.20	
MSASH45MSB5105□TNA01	HMK432 BJ105□M-T	100	B	X5R ^{*1}	1 μ	±10, ±20	3.5	200	2.5±0.20	
MSASH45MSB5155□TNA01	HMK432 BJ155□M-T	100	B	X5R ^{*1}	1.5 μ	±10, ±20	3.5	200	2.5±0.20	
MSASH45MSB5225□TNA01	HMK432 BJ225□M-T	100	B	X5R ^{*1}	2.2 μ	±10, ±20	3.5	200	2.5±0.20	
MSASQ45MSB5104□TNA01	QMK432 BJ104□M-T	250	B	X5R ^{*1}	0.1 μ	±10, ±20	2.5	150	2.5±0.20	
MSASQ45MSB5224□TNA01	QMK432 BJ224□M-T	250	B	X5R ^{*1}	0.22 μ	±10, ±20	2.5	150	2.5±0.20	
MSASQ45MSB5334□TNA01	QMK432 BJ334□M-T	250	B	X5R ^{*1}	0.33 μ	±10, ±20	2.5	150	2.5±0.20	
MSASQ45MSB5474□TNA01	QMK432 BJ474□M-T	250	B	X5R ^{*1}	0.47 μ	±10, ±20	2.5	150	2.5±0.20	
MSASS45MSB5473□TNA01	SMK432 BJ473□M-T	630	B	X5R ^{*1}	0.047 μ	±10, ±20	2.5	120	2.5±0.20	
MSASS45MSB5683□TNA01	SMK432 BJ683□M-T	630	B	X5R ^{*1}	0.068 μ	±10, ±20	2.5	120	2.5±0.20	
MSASS45MSB5104□TNA01	SMK432 BJ104□M-T	630	B	X5R ^{*1}	0.1 μ	±10, ±20	2.5	120	2.5±0.20	

【Temperature Characteristic B7 : X7R (−55~+125°C)】 2.5mm thickness

New part number	Old part number (for reference)	Rated voltage [V]	Temperature characteristics		Capacitance [F]	Capacitance tolerance [%]	tan δ [%]	HTLT	Thickness ^{*3} [mm]	Note
								Rated voltage x %		
MSASH45MSB7474□TNA01	HMK432 B7474□M-T	100		X7R	0.47 μ	±10, ±20	3.5	200	2.5±0.20	
MSASH45MSB7105□TNA01	HMK432 B7105□M-T	100		X7R	1 μ	±10, ±20	3.5	200	2.5±0.20	
MSASH45MSB7155□TNA01	HMK432 B7155□M-T	100		X7R	1.5 μ	±10, ±20	3.5	200	2.5±0.20	
MSASH45MSB7225□TNA01	HMK432 B7225□M-T	100		X7R	2.2 μ	±10, ±20	3.5	200	2.5±0.20	
MSASQ45MSB7104□TNA01	QMK432 B7104□M-T	250		X7R	0.1 μ	±10, ±20	2.5	150	2.5±0.20	
MSASQ45MSB7224□TNA01	QMK432 B7224□M-T	250		X7R	0.22 μ	±10, ±20	2.5	150	2.5±0.20	
MSASQ45MSB7334□TNA01	QMK432 B7334□M-T	250		X7R	0.33 μ	±10, ±20	2.5	150	2.5±0.20	
MSASQ45MSB7474□TNA01	QMK432 B7474□M-T	250		X7R	0.47 μ	±10, ±20	2.5	150	2.5±0.20	
MSASS45MSB7473□TNA01	SMK432 B7473□M-T	630		X7R	0.047 μ	±10, ±20	2.5	120	2.5±0.20	
MSASS45MSB7683□TNA01	SMK432 B7683□M-T	630		X7R	0.068 μ	±10, ±20	2.5	120	2.5±0.20	
MSASS45MSB7104□TNA01	SMK432 B7104□M-T	630		X7R	0.1 μ	±10, ±20	2.5	120	2.5±0.20	

【Temperature Characteristic B7 : X7R (−55~+125°C)】 2.0mm thickness

New part number	Old part number (for reference)	Rated voltage [V]	Temperature characteristics		Capacitance [F]	Capacitance tolerance [%]	tan δ [%]	HTLT	Thickness ^{*3} [mm]	Note
								Rated voltage x %		
MSASX45YAB7222KTCA01	XMK432 B7222KY-TE	2000		X7R	2200 p	±10	2.5	110	2.0+0/-0.30	
MSASX45YAB7472KTCA01	XMK432 B7472KY-TE	2000		X7R	4700 p	±10	2.5	110	2.0+0/-0.30	

PARTS NUMBER

LW Reversal Decoupling Low ESL Capacitors (LWDC™) for General Electronic Equipment for Consumer

● 0510TYPE

【Temperature Characteristic B5(BJ) : X5R (−55~+85°C)】 0.3mm thickness

New part number	Old part number (for reference)	Rated voltage [V]	Temperature characteristics	Capacitance [F]	Capacitance tolerance [%]	tan δ [%]	HTLT	Thickness*3 [mm]	Note
							Rated voltage x %		
MSRLT103SB5104MFNA01	TWK105 BJ104MP-F	25	X5R	0.1 μ	±20	5	150	0.3±0.05	
MSRLE103SB5224MFNA01	EWK105 BJ224MP-F	16	X5R	0.22 μ	±20	10	150	0.3±0.05	
MSRLL103SB5474MFNA01	LWK105 BJ474MP-F	10	X5R	0.47 μ	±20	10	150	0.3±0.05	
MSRLJ103SB5104MFNA01	JWK105 BJ104MP-F	6.3	X5R ^{*1}	0.1 μ	±20	5	150	0.3±0.05	
MSRLJ103SB5474MFNA01	JWK105 BJ474MP-F	6.3	X5R ^{*1}	0.47 μ	±20	10	150	0.3±0.05	
MSRLJ103SB5105MFNA01	JWK105 BJ105MP-F	6.3	X5R	1 μ	±20	10	150	0.3±0.05	
MSRLJ103SB5225MFNA01	JWK105 BJ225MP-F	6.3	X5R	2.2 μ	±20	10	150	0.3±0.05	

【Temperature Characteristic C6 : X6S (−55~+105°C), C7 : X7S (−55~+125°C)】 0.3mm thickness

New part number	Old part number (for reference)	Rated voltage [V]	Temperature characteristics	Capacitance [F]	Capacitance tolerance [%]	tan δ [%]	HTLT	Thickness*3 [mm]	Note
							Rated voltage x %		
MSRLE103SC6104MFNA01	EWK105 C6104MP-F	16	X6S	0.1 μ	±20	5	150	0.3±0.05	
MSRLL103SC7104MFNA01	LWK105 C7104MP-F	10	X7S	0.1 μ	±20	5	150	0.3±0.05	
MSRLL103SC6224MFNA01	LWK105 C6224MP-F	10	X6S	0.22 μ	±20	10	150	0.3±0.05	
MSRLJ103SC7104MFNA01	JWK105 C7104MP-F	6.3	X7S	0.1 μ	±20	5	150	0.3±0.05	
MSRLJ103SC7224MFNA01	JWK105 C7224MP-F	6.3	X7S	0.22 μ	±20	10	150	0.3±0.05	
MSRLJ103SC6474MFNA01	JWK105 C6474MP-F	6.3	X6S	0.47 μ	±20	10	150	0.3±0.05	
MSRLA103SC6224MFNA01	AWK105 C6224MP-F	4	X6S	0.22 μ	±20	10	150	0.3±0.05	
MSRLA103SC6474MFNA01	AWK105 C6474MP-F	4	X6S	0.47 μ	±20	10	150	0.3±0.05	
MSRLA103SC6105MFNA01	AWK105 C6105MP-F	4	X6S	1 μ	±20	10	150	0.3±0.05	
MSRLA103SC6225MFNA01	AWK105 C6225MP-F	4	X6S	2.2 μ	±20	10	150	0.3±0.05	

● 0816TYPE

【Temperature Characteristic B5(BJ) : X5R (−55~+85°C)】 0.5mm thickness

New part number	Old part number (for reference)	Rated voltage [V]	Temperature characteristics	Capacitance [F]	Capacitance tolerance [%]	tan δ [%]	HTLT	Thickness*3 [mm]	Note
							Rated voltage x %		
MSRLT165SB5104MTNA01	TWK107 BJ104MV-T	25	X5R ^{*1}	0.1 μ	±20	5	150	0.5±0.05	
MSRLE165SB5224MTNA01	EWK107 BJ224MV-T	16	X5R ^{*1}	0.22 μ	±20	5	150	0.5±0.05	
MSRLE165SB5474MTNA01	EWK107 BJ474MV-T	16	X5R ^{*1}	0.47 μ	±20	5	150	0.5±0.05	
MSRLL165SB5105MTNA01	LWK107 BJ105MV-T	10	X5R	1 μ	±20	10	150	0.5±0.05	
MSRLL165SB5225MTNA01	LWK107 BJ225MV-T	10	X5R	2.2 μ	±20	10	150	0.5±0.05	
MSRLJ165SB5105MTNA01	JWK107 BJ105MV-T	6.3	X5R ^{*1}	1 μ	±20	10	150	0.5±0.05	
MSRLJ165SB5225MTNA01	JWK107 BJ225MV-T	6.3	X5R	2.2 μ	±20	10	150	0.5±0.05	
MSRLJ165SB5475MTNA01	JWK107 BJ475MV-T	6.3	X5R	4.7 μ	±20	10	150	0.5±0.05	
MSRLA165SB5106MTNA01	AWK107 BJ106MV-T	4	X5R	10 μ	±20	10	150	0.5±0.05	

【Temperature Characteristic B7 : X7R (−55~+125°C), C6 : X6S (−55~+105°C), C7 : X7S (−55~+125°C)】 0.5mm thickness

New part number	Old part number (for reference)	Rated voltage [V]	Temperature characteristics	Capacitance [F]	Capacitance tolerance [%]	tan δ [%]	HTLT	Thickness*3 [mm]	Note
							Rated voltage x %		
MSRLT165SB7104MTNA01	TWK107 B7104MV-T	25	X7R	0.1 μ	±20	5	150	0.5±0.05	
MSRLE165SB7224MTNA01	EWK107 B7224MV-T	16	X7R	0.22 μ	±20	5	150	0.5±0.05	
MSRLE165SB7474MTNA01	EWK107 B7474MV-T	16	X7R	0.47 μ	±20	5	150	0.5±0.05	
MSRLJ165SC7105MTNA01	JWK107 C7105MV-T	6.3	X7S	1 μ	±20	10	150	0.5±0.05	
MSRLA165SC7225MTNA01	AWK107 C7225MV-T	4	X7S	2.2 μ	±20	10	150	0.5±0.05	
MSRLA165SC6475MTNA01	AWK107 C6475MV-T	4	X6S	4.7 μ	±20	10	150	0.5±0.05	
MSRLP165SC6106MTNA01	PWK107 C6106MV-T	2.5	X6S	10 μ	±20	10	150	0.5±0.05	

● 1220TYPE

【Temperature Characteristic B5(BJ) : X5R (−55~+85°C)】 0.85mm thickness

New part number	Old part number (for reference)	Rated voltage [V]	Temperature characteristics	Capacitance [F]	Capacitance tolerance [%]	tan δ [%]	HTLT	Thickness*3 [mm]	Note
							Rated voltage x %		
MSRLT219SB5475□TNA01	TWK212 BJ475□D-T	25	X5R	4.7 μ	±10, ±20	10	150	0.85±0.10	
MSRLE219SB5106MTNA01	EWK212 BJ106MD-T	16	X5R	10 μ	±20	10	150	0.85±0.10	
MSRLL219SB5475□TNA01	LWK212 BJ475□D-T	10	X5R	4.7 μ	±10, ±20	10	150	0.85±0.10	
MSRLL219SB5106MTNA01	LWK212 BJ106MD-T	10	X5R	10 μ	±20	10	150	0.85±0.10	
MSRLJ219SB5226MTNA01	JWK212 BJ226MD-T	6.3	X5R	22 μ	±20	10	150	0.85±0.10	

【Temperature Characteristic B7 : X7R (−55~+125°C), C6 : X6S (−55~+105°C)】 0.85mm thickness

New part number	Old part number (for reference)	Rated voltage [V]	Temperature characteristics	Capacitance [F]	Capacitance tolerance [%]	tan δ [%]	HTLT	Thickness*3 [mm]	Note
							Rated voltage x %		
MSRLT219SB7225□TNA01	TWK212 B7225□D-T	25	X7R	2.2 μ	±10, ±20	5	150	0.85±0.10	
MSRLE219SC6475□TNA01	EWK212 C6475□D-T	16	X6S	4.7 μ	±10, ±20	10	150	0.85±0.10	
MSRLL219SC6106MTNA01	LWK212 C6106MD-T	10	X6S	10 μ	±20	10	150	0.85±0.10	
MSRLA219SC6226MTNA01	AWK212 C6226MD-T	4	X6S	22 μ	±20	10	150	0.85±0.10	

Multilayer Ceramic Capacitors

PACKAGING

① Minimum Quantity

● Taped package

Type			Thickness		Standard Quantity [pcs]	
Code	JIS(mm)	EIA(inch)	[mm]	Code	Paper tape	Embossed tape
02	0201	008004	0.125	1	—	50000
04	0402	01005	0.2	2	—	40000
06	0603	0201	0.3	3	15000	—
1L	1005	0402	0.13	H	—	20000
			0.18	E	—	15000
			0.2	2	20000	—
			0.3	3	15000	—
10	1005	0402	0.5	5	10000	—
	0510 ※	0204	0.3	3	10000	—
16	1608	0603	0.45	K	4000	—
			0.7	7		
			0.8	8		
			0.8	8	3000 (Soft Termination)	3000 (Soft Termination)
	0816 ※	0306	0.5	5	—	4000
21	2012	0805	0.85	9	4000	—
			1.25	G	—	3000
			1.25	G	—	2000 (Soft Termination)
	1220 ※	0508	0.85	9	4000	—
31	3216	1206	0.85	9	4000	—
			1.15	Q	—	3000
			1.6	L	—	2000
32	3225	1210	0.85	9	—	2000
			1.15	Q		
			1.9	N		
			2.0 max	Y		
			2.5	M	—	500(T), 1000(P)
45	4532	1812	2.0 max	Y	—	1000
			2.5	M	—	500

注: ※LW Reverse type (MSRL, MCRL, MBRL, MLRL, MMRL)

② Taping material

※ No bottom tape for pressed carrier tape

- Card board carrier tape
- Embossed tape

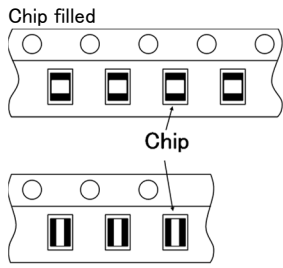
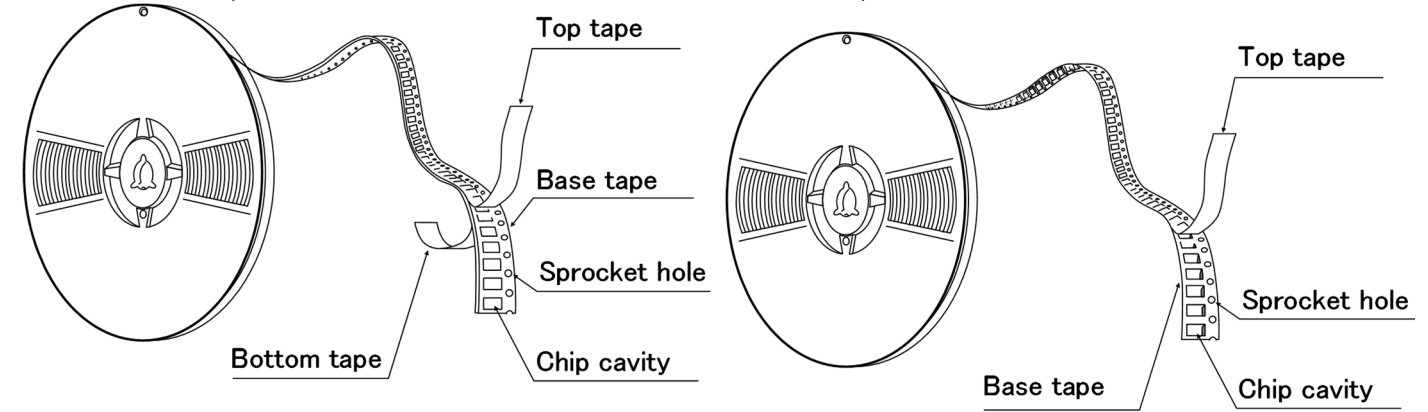

※ LW Reverse type.

③ Representative taping dimensions

● Paper Tape (8mm wide)

● Pressed carrier tape (2mm pitch)

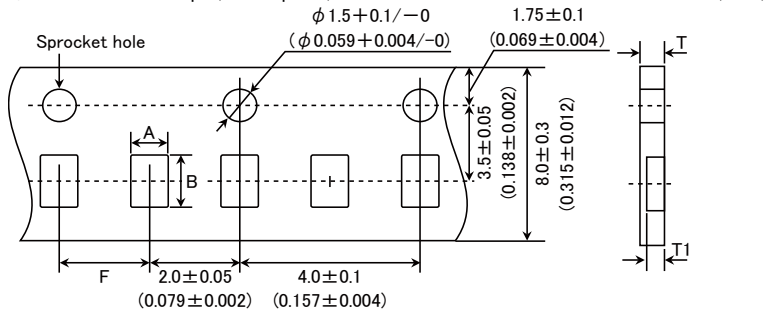

Type(EIA)	Chip Cavity		Insertion Pitch F	Tape Thickness	
	A	B		T	T1
0603 (0201)	0.37	0.67	2.0±0.05	0.45max.	0.42max.
0510 (0204) ※	0.65	1.15		0.4max.	0.3max.
1005 (0402) (*1 2)				0.45max.	0.42max.
1005 (0402) (*1 3)					

Note *1 Thickness, 2:0.2mm, 3:0.3mm. ※ LW Reverse type.

Unit: mm

● Punched carrier tape (2mm pitch)

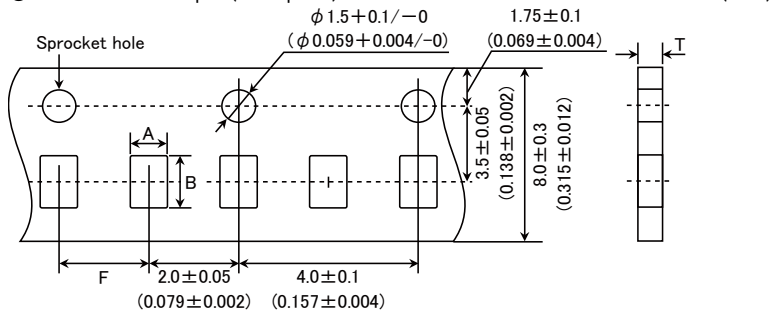

Type(EIA)	Chip Cavity		Insertion Pitch F	Tape Thickness
	A	B		T
1005 (0402)	0.65	1.15	2.0±0.05	0.8max.

Unit: mm

▶ This catalog contains the typical specification only due to the limitation of space. When you consider the purchase of our products, please check our specification. For details of each product (characteristics graph, reliability information, precautions for use, and so on), see our Web site (<http://www.ty-top.com/>).

● Punched carrier tape (4mm pitch)

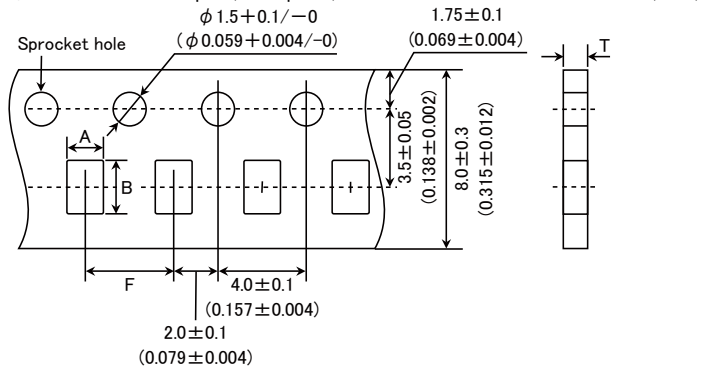

Type(EIA)	Chip Cavity		Insertion Pitch F	Tape Thickness	
	A	B		K	T
1608 (0603)	1.0	1.8	4.0 ± 0.1	1.1max.	
0816 (0306) ※					
2012 (0805)					
1220 (0508) ※	1.65	2.4		1.1max.	
3216 (1206)	2.0	3.6			

Note: Taping size might be different depending on the size of the product. ※ LW Reverse type.

Unit: mm

● Embossed tape (4mm wide)

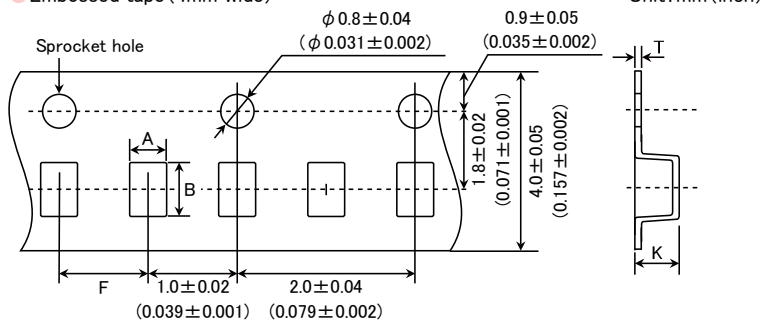

Type(EIA)	Chip Cavity		Insertion Pitch F	Tape Thickness	
	A	B		K	T
0201 (008004)	0.135	0.27	1.0 ± 0.02	0.5max.	0.25max.
0402 (01005)					

Unit: mm

● Embossed tape (8mm wide)

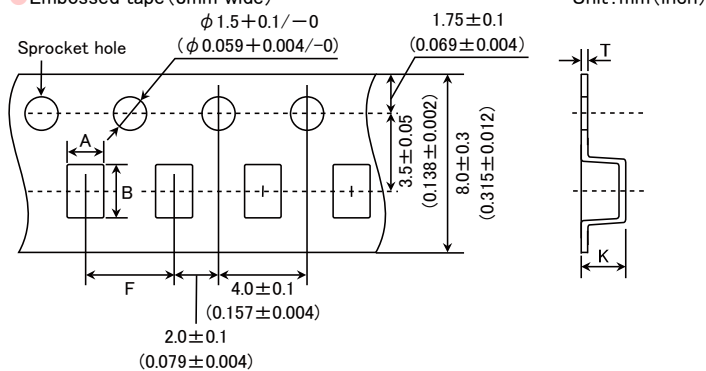

Type(EIA)	Chip Cavity		Insertion Pitch F	Tape Thickness	
	A	B		K	T
1005 (0402)	1.0	1.8	4.0 ± 0.1	0.6max	0.2 ± 0.1
0816 (0306) ※				1.3max.	0.25 ± 0.1
2012 (0805)				3.4max.	0.6max.
3216 (1206)					
3225 (1210)					

Note: ※ LW Reverse type.

Unit: mm

► This catalog contains the typical specification only due to the limitation of space. When you consider the purchase of our products, please check our specification. For details of each product (characteristics graph, reliability information, precautions for use, and so on), see our Web site (<http://www.ty-top.com/>).

● Embossed tape (12mm wide) Unit: mm (inch)

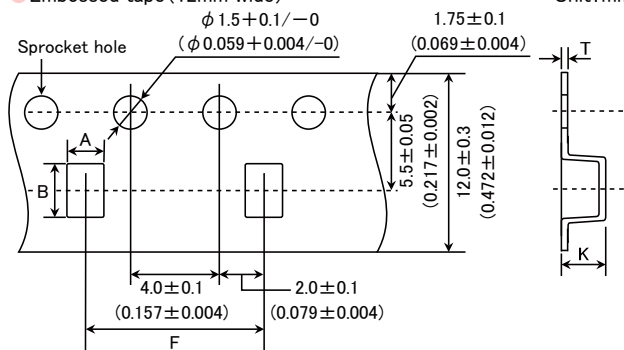

Type(EIA)	Chip Cavity		Insertion Pitch	Tape Thickness	
	A	B		K	T
3225 (1210)	3.1	4.0	8.0 ± 0.1	4.0max.	0.6max.
4532 (1812)	3.7	4.9	8.0 ± 0.1	4.0max.	0.6max.

Unit: mm

④ Trailer and Leader

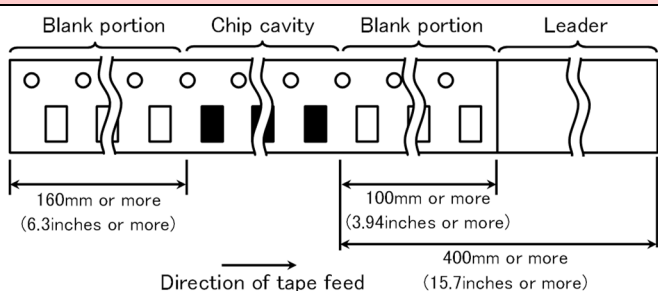

⑤ Reel size

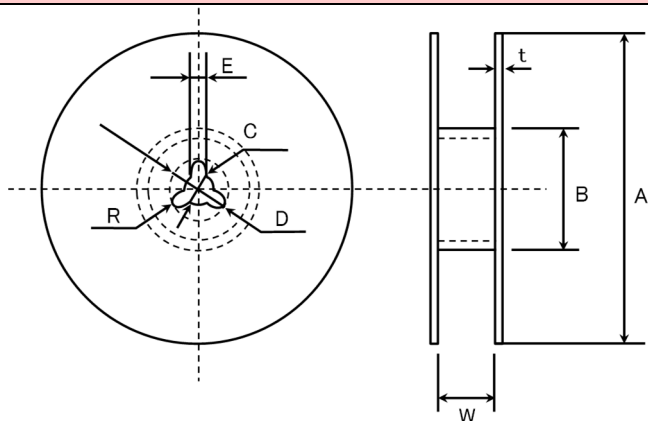

A	B	C	D	E	R
φ178 ± 2.0	φ50min.	φ13.0 ± 0.2	φ21.0 ± 0.8	2.0 ± 0.5	1.0

	T	W
4mm wide tape	1.5max.	5 ± 1.0
8mm wide tape	2.5max.	10 ± 1.5
12mm wide tape	2.5max.	14 ± 1.5

Unit: mm

⑥ Top Tape Strength

The top tape requires a peel-off force of 0.1 to 0.7N in the direction of the arrow as illustrated below.

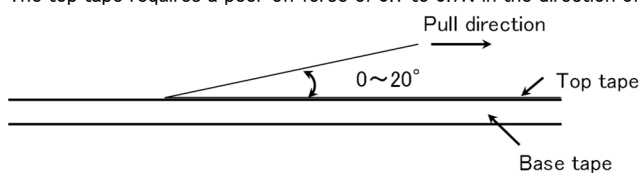

▶ This catalog contains the typical specification only due to the limitation of space. When you consider the purchase of our products, please check our specification. For details of each product (characteristics graph, reliability information, precautions for use, and so on), see our Web site (<http://www.ty-top.com/>).

Multilayer Ceramic Capacitors for General Electronic Equipment for Consumer
Multilayer Ceramic Capacitors
for Medical Devices classified as GHTF Classes A or B (Japan Classes I or II)

■ RELIABILITY DATA

1. Operating Temperature Range

Specified Value	Temperature Compensating (Class1)	Standard	-55 to +125°C	
		High Frequency Type		
Specified Value	High Permittivity (Class2)		Specification	Temperature Range
		B5	B	-25 to +85°C
			X5R	-55 to +85°C
		B7	X7R	-55 to +125°C
		C6	X6S	-55 to +105°C
C7	X7S	-55 to +125°C		

2. Storage Conditions

Specified Value	Temperature Compensating (Class1)	Standard	-55 to +125°C	
		High Frequency Type		
Specified Value	High Permittivity (Class2)		Specification	Temperature Range
		B5	B	-25 to +85°C
			X5R	-55 to +85°C
		B7	X7R	-55 to +125°C
		C6	X6S	-55 to +105°C
C7	X7S	-55 to +125°C		

3. Rated Voltage

Specified Value	Temperature Compensating (Class1)	Standard	50VDC, 25VDC, 16VDC
		High Frequency Type	25VDC, 16VDC
	High Permittivity (Class2)		50VDC, 35VDC, 25VDC, 16VDC, 10VDC, 6.3VDC, 4VDC, 2.5VDC

4. Withstanding Voltage (Between terminals)

Specified Value	Temperature Compensating (Class1)	Standard	No breakdown or damage
		High Frequency Type	
Test Methods and Remarks	High Permittivity (Class2)		
		Class 1	Class 2
	Applied voltage	Rated voltage × 3	Rated voltage × 2.5
	Duration	1 to 5 sec.	
	Charge/discharge current	50mA max.	

5. Insulation Resistance

Specified Value	Temperature Compensating (Class1)	Standard	10000 MΩ min.
		High Frequency Type	
Test Methods and Remarks	High Permittivity (Class2) Note 1		C ≤ 0.047 μF : 10000 MΩ min. C > 0.047 μF : 500MΩ · μF (C: Nominal capacitance)
	Applied voltage	: Rated voltage	
	Duration	: 60 ± 5 sec.	
	Charge/discharge current	: 50mA max.	

► This catalog contains the typical specification only due to the limitation of space. When you consider the purchase of our products, please check our specification. For details of each product (characteristics graph, reliability information, precautions for use, and so on), see our Web site (<http://www.ty-top.com/>).

6. Capacitance (Tolerance)

Specified Value	Temperature Compensating (Class1)	Standard	$0.2\text{pF} \leq C \leq 5\text{pF} : \pm 0.25\text{pF}$ $5\text{pF} \leq C \leq 10\text{pF} : \pm 0.5\text{pF}$ $C > 10\text{pF} : \pm 5\%$	
		High Frequency Type	Refer to detailed specification	
	High Permittivity (Class2)		$\pm 10\%$ or $\pm 20\%$	
Test Methods and Remarks		Class 1		Class 2
		Standard	High Frequency Type	$C \leq 10 \mu\text{F}$ $C > 10 \mu\text{F}$
	Preconditioning	None		Thermal treatment (at 150°C for 1hr) Note 2
	Measuring frequency	1MHz \pm 10%	1GHz	$1\text{kHz} \pm 10\%$ $120 \pm 10\text{Hz}$
	Measuring voltage Note 1	0.5 to 5Vrms		$1 \pm 0.2\text{Vrms}$ $0.5 \pm 0.1\text{Vrms}$
Bias application	None			

7. Q or Dissipation Factor

Specified Value	Temperature Compensating (Class1)	Standard	$C < 30\text{pF} : Q \geq 400 + 20C$ $C \geq 30\text{pF} : Q \geq 1000$ (C: Nominal capacitance)	
		High Frequency Type	Refer to detailed specification	
	High Permittivity (Class2) Note 1		2.5% max.	
Test Methods and Remarks		Class 1		Class 2
		Standard	High Frequency Type	$C \leq 10 \mu\text{F}$ $C > 10 \mu\text{F}$
	Preconditioning	None		Thermal treatment (at 150°C for 1hr) Note 2
	Measuring frequency	1MHz \pm 10%	1GHz	$1\text{kHz} \pm 10\%$ $120 \pm 10\text{Hz}$
	Measuring voltage Note 1	0.5 to 5Vrms		$1 \pm 0.2\text{Vrms}$ $0.5 \pm 0.1\text{Vrms}$
Bias application	None			

8. Temperature Characteristic (Without voltage application)

Specified Value	Temperature Compensating (Class1)	Standard	Temperature Characteristic [ppm/°C]		Tolerance [ppm/°C]		
			$C \square : 0$	CG(C0G) CH(C0H) CJ(C0J) CK(C0K)	G: ± 30 H: ± 60 J: ± 120 H: ± 250		
	High Frequency Type		Temperature Characteristic [ppm/°C]		Tolerance [ppm/°C]		
			$C \square : 0$	CG(C0G) CH(C0H)	G: ± 30 H: ± 60		
	High Permittivity (Class2)			Specification	Capacitance change	Reference temperature	Temperature Range
			B5	B X5R	$\pm 10\%$ $\pm 15\%$	20°C 25°C	-25 to +85°C -55 to +85°C
			B7	X7R	$\pm 15\%$	25°C	-55 to +125°C
			C6	XS	$\pm 22\%$	25°C	-55 to +105°C
			C7	X7S	$\pm 22\%$	25°C	-55 to +125°C

Test Methods and Remarks	Class 1 Capacitance at 20°C and 85°C shall be measured in thermal equilibrium, and the temperature characteristic shall be calculated from the following equation.			
	$\frac{(C_{85} - C_{20})}{C_{20} \times \Delta T} \times 10^6 (\text{ppm}/^\circ\text{C}) \quad \Delta T = 65$			
	Class 2 Capacitance at each step shall be measured in thermal equilibrium, and the temperature characteristic shall be calculated from the following equation.			
	Step	B	X5R, X7R, X6S, X7S	
	1	Minimum operating temperature		
2	20°C	25°C		
3	Maximum operating temperature			
	$\frac{(C - C_2)}{C_2} \times 100 (\%)$		C : Capacitance in Step 1 or Step 3 C ₂ : Capacitance in Step 2	
	※Measuring frequency and voltage: Refer to detailed specification			

► This catalog contains the typical specification only due to the limitation of space. When you consider the purchase of our products, please check our specification. For details of each product (characteristics graph, reliability information, precautions for use, and so on), see our Web site (<http://www.ty-top.com/>).

9. Deflection

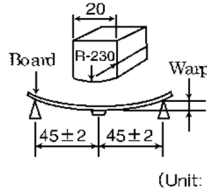
Specified Value	Temperature Compensating (Class1)	Standard	Appearance : No abnormality Capacitance change : Within $\pm 5\%$ or ± 0.5 pF, whichever is larger.	
		High Frequency Type	Appearance : No abnormality Capacitance change : Within ± 0.5 pF	
	High Permittivity (Class2)		Appearance : No abnormality Capacitance change : Within $\pm 12.5\%$	
Test Methods and Remarks	Multilayer Ceramic Capacitors		 <p>(Unit: mm) Capacitance measurement shall be conducted with the board bent</p>	
		0201, 0402, 0603, ※1005 Type		
		The other types		
	Board	Glass epoxy-resin substrate		
	Thickness	0.8mm		1.6mm
	Warp	1mm		
	Duration	10 sec.		
※1005 Type thickness, 2: 0.2mm, 3: 0.3mm.				

10. Adhesive Strength of Terminal Electrodes

Specified Value	Temperature Compensating (Class1)	Standard	No terminal separation or its indication.	
		High Frequency Type		
	High Permittivity (Class2)			
Test Methods and Remarks		0201Type	0402, 0603Type	1005Type or more
	Applied force	1N	2N	5N
	Duration	10 ± 1 sec		30 ± 5 sec

11. Vibration

Specified Value	Temperature Compensating (Class1)	Standard	Initial performance shall be satisfied.
		High Frequency Type	
	High Permittivity (Class2)		
Test Methods and Remarks	Preconditioning	: Thermal treatment (at 150°C for 1hr) Note2 (Only High permittivity)	
	Frequency range	: 10 to 55 Hz	
	Overall amplitude	: 1.5 mm	
	Sweeping method	: 10 to 55 to 10 Hz for 1 min Two hours each in X, Y, Z directions: 6 hrs in total	

12. Solderability

Specified Value	Temperature Compensating (Class1)	Standard	At least 95% of terminal electrode is covered by new solder.
		High Frequency Type	
	High Permittivity (Class2)		
Test Methods and Remarks		Eutectic solder	Lead-free solder
	Solder type	H60A or H63A	Sn-3.0Ag-0.5Cu
	Solder temperature	230 ± 5°C	
	Duration	4 ± 1 sec.	

13. Resistance to Soldering

Specified Value	Temperature Compensating (Class1)	Standard	Appearance : No abnormality Capacitance change : Within $\pm 2.5\%$ or $\pm 0.25\text{pF}$, whichever is larger. Q : Initial value Insulation resistance : Initial value Withstanding voltage (between terminals) : No abnormality	
		High Frequency Type	Appearance : No abnormality Capacitance change : Within $\pm 2.5\%$ or $\pm 0.25\text{pF}$, whichever is larger. Q : Initial value Insulation resistance : Initial value Withstanding voltage (between terminals) : No abnormality	
	High Permittivity (Class2) Note 1		Appearance : No abnormality Capacitance change : Within $\pm 7.5\%$ Dissipation factor : Initial value Insulation resistance : Initial value Withstanding voltage (between terminals) : No abnormality	
Test Methods and Remarks	Class 1			
		0201, 0402, 0603 Type	1005 Type	
	Preconditioning	None		
	Preheating	150°C, 1 to 2 min.	80 to 100°C, 2 to 5 min. 150 to 200°C, 2 to 5 min.	
	Solder temp.	270 \pm 5°C		
	Duration	3 \pm 0.5 sec.		
	Recovery	24 \pm 2 hrs (Standard condition) Note 5		
	Class 2			
		0201, 0402, 0603 Type	1005, 1608, 2012 Type	3216, 3225, 4532 Type
	Preconditioning	Thermal treatment (at 150°C for 1 hr) Note 2		
	Preheating	150°C, 1 to 2 min.	80 to 100°C, 2 to 5 min. 150 to 200°C, 2 to 5 min.	80 to 100°C, 5 to 10 min. 150 to 200°C, 5 to 10 min.
	Solder temp.	270 \pm 5°C		
	Duration	3 \pm 0.5 sec.		
	Recovery	24 \pm 2 hrs (Standard condition) Note 5		

14. Temperature Cycle (Thermal Shock)

Specified Value	Temperature Compensating (Class1)	Standard	Appearance : No abnormality Capacitance change : Within $\pm 2.5\%$ or $\pm 0.25\text{pF}$, whichever is larger. Q : Initial value Insulation resistance : Initial value Withstanding voltage (between terminals) : No abnormality	
		High Frequency Type	Appearance : No abnormality Capacitance change : Within $\pm 2.5\%$ or $\pm 0.25\text{pF}$, whichever is larger. Q : Initial value Insulation resistance : Initial value Withstanding voltage (between terminals) : No abnormality	
	High Permittivity (Class2) Note 1		Appearance : No abnormality Capacitance change : Within $\pm 7.5\%$ Dissipation factor : Initial value Insulation resistance : Initial value Withstanding voltage (between terminals) : No abnormality	
Test Methods and Remarks	Class 1		Class 2	
	Preconditioning	None	Thermal treatment (at 150°C for 1 hr) Note 2	
	1 cycle	Step	Temperature (°C)	Time (min.)
		1	Minimum operating temperature	30 \pm 3
		2	Normal temperature	2 to 3
		3	Maximum operating temperature	30 \pm 3
	4	Normal temperature	2 to 3	
Number of cycles	5 times			
Recovery	24 \pm 2 hrs (Standard condition) Note 5			

► This catalog contains the typical specification only due to the limitation of space. When you consider the purchase of our products, please check our specification. For details of each product (characteristics graph, reliability information, precautions for use, and so on), see our Web site (<http://www.ty-top.com/>).

15. Humidity (Steady State)			
Specified Value	Temperature Compensating (Class1)	Standard	Appearance : No abnormality Capacitance change : Within $\pm 5\%$ or $\pm 0.5\text{pF}$, whichever is larger. Q : $C < 10\text{pF} : Q \geq 200 + 10C$ $10 \leq C < 30\text{pF} : Q \geq 275 + 2.5C$ $C \geq 30\text{pF} : Q \geq 350$ (C: Nominal capacitance) Insulation resistance : 1000 M Ω min.
		High Frequency Type	Appearance : No abnormality Capacitance change : Within $\pm 5\%$ or $\pm 0.5\text{pF}$, whichever is larger. Insulation resistance : 1000 M Ω min.
	High Permittivity (Class2) Note 1		Appearance : No abnormality Capacitance change : Within $\pm 12.5\%$ Dissipation factor : 5.0% max. Insulation resistance : 50 M Ω μF or 1000 M Ω whichever is smaller.
Test Methods and Remarks	Preconditioning : Thermal treatment (at 150°C for 1hr) Note2 (Only High permittivity) Temperature : $40 \pm 2^\circ\text{C}$ Humidity : 90 to 95%RH Duration : 500 +24/−0 hrs Recovery : 24 ± 2 hrs under the standard condition Note 1,5		

16. Humidity Loading			
Specified Value	Temperature Compensating (Class1)	Standard	Appearance : No abnormality Capacitance change : Within $\pm 7.5\%$ or $\pm 0.75\text{pF}$, whichever is larger. Q : $C < 30\text{pF} : Q \geq 100 + 10C/3$ $C \geq 30\text{pF} : Q \geq 200$ (C: Nominal capacitance) Insulation resistance : 500 M Ω min.
		High Frequency Type	Appearance : No abnormality Capacitance change : $C \leq 2\text{pF} : \text{Within } \pm 0.4 \text{ pF}$ $C > 2\text{pF} : \text{Within } \pm 0.75 \text{ pF}$ $C > 10\text{pF} : \text{Within } \pm 0.75\% \text{ (C: Nominal capacitance)}$ Insulation resistance : 500 M Ω min.
	High Permittivity (Class2) Note 1		Appearance : No abnormality Capacitance change : Within $\pm 12.5\%$ Dissipation factor : 5.0% max. Insulation resistance : 25 M Ω μF or 500 M Ω , whichever is smaller.
Test Methods and Remarks	Preconditioning : Voltage treatment (Rated voltage are applied for 1 hour at 40°C) Note 1,3 (Only High permittivity) Temperature : $40 \pm 2^\circ\text{C}$ Humidity : 90 to 95%RH Duration : 500 +24/−0 hrs Applied voltage : Rated voltage Charge/discharge current : 50mA max. Recovery : 24 ± 2 hrs under the standard condition Note 1,5		

17. High Temperature Loading

Specified Value	Temperature Compensating (Class1)	Standard	Appearance : No abnormality Capacitance change : Within $\pm 3\%$ or $\pm 0.3\text{pF}$, whichever is larger. Q : $C < 10\text{pF}$: $Q \geq 200 + 10C$ $10 \leq C < 30\text{pF}$: $Q \geq 275 + 2.5C$ $C \geq 30\text{pF}$: $Q \geq 350$ (C: Nominal capacitance) Insulation resistance : $1000 \text{ M}\Omega$ min.
		High Frequency Type	Appearance : No abnormality Capacitance change : Within $\pm 3\%$ or $\pm 0.3\text{pF}$, whichever is larger. Insulation resistance : $1000 \text{ M}\Omega$ min.
	High Permittivity (Class2) Note 1	Appearance : No abnormality Capacitance change : Within $\pm 12.5\%$ Dissipation factor : 5.0% max. Insulation resistance : $50 \text{ M}\Omega \mu\text{F}$ or $1000 \text{ M}\Omega$, whichever is smaller.	
Test Methods and Remarks	Preconditioning : Voltage treatment (Twice the rated voltage shall be applied for 1 hour at 85°C , 105°C or 125°C) Note 1,3,4 (Only High permittivity) Temperature : Maximum operating temperature Duration : $1000 +24/-0$ hrs Applied voltage : Rated voltage $\times 2$ Note 4 Charge/discharge current : 50mA max. Recovery : 24 ± 2 hrs under the standard condition Note 1,5		

Note 1 The figures indicate typical specifications. Please refer to individual specifications in detail.

Note 2 Thermal treatment : Initial value shall be measured after test sample is heat-treated at $150 \pm 0 / -10^\circ\text{C}$ for an hour and kept at room temperature for 24 ± 2 hours.

Note 3 Voltage treatment : Initial value shall be measured after test sample is voltage-treated for an hour at both the temperature and voltage specified in the test conditions, and kept at room temperature for 24 ± 2 hours.

Note 4 150% of rated voltage is applicable to some items. Please refer to their specifications for further information.

Note 5 Standard condition: Temperature: 5 to 35°C , Relative humidity: 45 to 85% RH, Air pressure: 86 to 106kPa When there are questions concerning measurement results, in order to provide correlation data, the test shall be conducted under the following condition.

Temperature: $20 \pm 2^\circ\text{C}$, Relative humidity: 60 to 70% RH, Air pressure: 86 to 106kPa Unless otherwise specified, all the tests are conducted under the "standard condition".

**Low distortion design/Audible/Good bias Multilayer Ceramic Capacitors
for General Electronic Equipment for Consumer**
**Low distortion design/Audible/Good bias Multilayer Ceramic Capacitors
for Medical Devices classified as GHTF Classes A or B (Japan Classes I or II)**

■ RELIABILITY DATA

1. Operating Temperature Range

Specified Value		Specification	Temperature Range
	LD	X5R	-55~+85°C
	SD	-	-55~+125°C

2. Storage Temperature Range

Specified Value		Specification	Temperature Range
	LD	X5R	-55~+85°C
	SD	-	-55~+125°C

3. Rated Voltage

Specified Value	6.3VDC, 10VDC, 16VDC, 25VDC, 35VDC, 50VDC
-----------------	---

4. Dielectric Withstanding Voltage (Between terminals)

Specified Value	No breakdown or damage	
Test Methods and Remarks	Applied voltage	: Rated voltage × 2.5(LD), Rated voltage × 3(SD)
	Duration	: 1 to 5 sec.
	Charge/discharge current	: 50mA max.

5. Insulation Resistance

Specified Value Note 1	10000 MΩ or 500MΩ μF, whichever is smaller	
Test Methods and Remarks	Applied voltage	: Rated voltage
	Duration	: 60±5 sec.
	Charge/discharge current	: 50mA max.

6. Capacitance (Tolerance)

Specified Value	±10% or ±20%	
Test Methods and Remarks	Measuring frequency	: 1kHz±10%
	Measuring voltage	: 1±0.2Vrms
	Bias application	: None

7. Dissipation Factor

Specified Value	10% max (LD), 0.1% max (SD)	
Test Methods and Remarks	Measuring frequency	: 1kHz±10%
	Measuring voltage	: 1±0.2Vrms
	Bias application	: None

► This catalog contains the typical specification only due to the limitation of space. When you consider the purchase of our products, please check our specification.
 For details of each product (characteristics graph, reliability information, precautions for use, and so on), see our Web site (<http://www.ty-top.com/>).

8. Temperature Characteristic (Without voltage application)

Specified Value	Specification		Capacitance change	Reference temperature	Temperature Range
	LD	X5R	± 15%	25°C	-55~+85°C
Test Methods and Remarks	Capacitance at each step shall be measured in thermal equilibrium, and the temperature characteristic shall be calculated from the following equation.				
	Step	X5R			
	1	Minimum operating temperature			
	2	25°C			
	3	Maximum operating temperature			
	$\frac{(C-C_2)}{C_2} \times 100(\%)$			C :Capacitance value in Step1 or Step3 C ₂ :Capacitance value in Step2	

9. Bending Strength

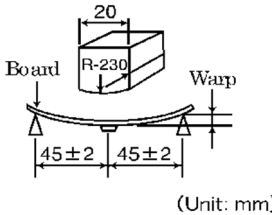
Specified Value	Appearance : No abnormality Capacitance change : Within ± 12.5% (LD), Within ± 5% (SD)
Test Methods and Remarks	Warp : 1mm Speed : 0.5mm/second Duration : 10 seconds Test board : glass epoxy resin substrate Thickness : 1.6mm  <p>(Unit: mm)</p> Capacitance measurement shall be conducted with the board bent.

10. Adhesive Force of Terminal Electrodes

Specified Value	Terminal electrodes shall be no exfoliation or a sign of exfoliation.
Test Methods and Remarks	Applied force : 5N Duration : 30 ± 5 seconds

11. Vibration

Specified Value	Initial performance shall be satisfied.
Test Methods and Remarks	Preconditioning : Thermal treatment (at 150°C for 1hr) Note2 (Only LD) Frequency range : 10 to 55 Hz Overall amplitude : 1.5 mm Sweeping method : 10 to 55 to 10 Hz for 1 min Two hours each in X, Y, Z directions: 6 hrs in total

12. Solderability

Specified Value	At least 95% of terminal electrode is covered by new solder.		
Test Methods and Remarks		Eutectic solder	Lead-free solder
	Solder type	H60A or H63A	Sn-3.0Ag-0.5Cu
	Solder temperature	230 ± 5°C	245 ± 3°C
	Duration	4 ± 1 sec.	

► This catalog contains the typical specification only due to the limitation of space. When you consider the purchase of our products, please check our specification. For details of each product (characteristics graph, reliability information, precautions for use, and so on), see our Web site (<http://www.ty-top.com/>).

13. Resistance to Soldering Heat

Specified Value	Appearance	: No abnormality																																					
	Capacitance change	: Within $\pm 7.5\%$ (LD), Within $\pm 2.5\%$ (SD)																																					
Specified Value	Dissipation factor	: Initial value																																					
	Insulation resistance	: Initial value																																					
Specified Value	Withstanding voltage (between terminals)	: No abnormality																																					
	Test Methods and Remarks	<table border="1"> <thead> <tr> <th rowspan="2"></th> <th colspan="2">LD</th> </tr> <tr> <th>1608、2012type</th> <th>3216、3225type</th> </tr> </thead> <tbody> <tr> <td>Preconditioning</td> <td colspan="2">Thermal treatment (at 150°C for 1 hr) Note 2</td> </tr> <tr> <td>Preheating conditions</td> <td>80 to 100°C 2 to 5 min 150 to 200°C 2 to 5 min</td> <td>80 to 100°C 5 to 10 min 150 to 200°C 5 to 10 min</td> </tr> <tr> <td>Solder temp.</td> <td colspan="2">270 \pm 5°C</td> </tr> <tr> <td>Duration</td> <td colspan="2">3 \pm 0.5 sec.</td> </tr> <tr> <td>Measurement shall be conducted</td> <td colspan="2">24 \pm 2hrs under the standard condition Note 5</td> </tr> </tbody> </table> <table border="1"> <thead> <tr> <th rowspan="2"></th> <th colspan="2">SD</th> </tr> <tr> <th>1005、1608、2012type</th> <th>3216type</th> </tr> </thead> <tbody> <tr> <td>Preheating conditions</td> <td>80 to 100°C 2 to 5 min 150 to 200°C 2 to 5 min</td> <td>80 to 100°C 5 to 10 min 150 to 200°C 5 to 10 min</td> </tr> <tr> <td>Solder temp.</td> <td colspan="2">270 \pm 5°C</td> </tr> <tr> <td>Duration</td> <td colspan="2">3 \pm 0.5 sec.</td> </tr> <tr> <td>Measurement shall be conducted</td> <td colspan="2">24 \pm 2hrs under the standard condition Note 5</td> </tr> </tbody> </table>			LD		1608、2012type	3216、3225type	Preconditioning	Thermal treatment (at 150°C for 1 hr) Note 2		Preheating conditions	80 to 100°C 2 to 5 min 150 to 200°C 2 to 5 min	80 to 100°C 5 to 10 min 150 to 200°C 5 to 10 min	Solder temp.	270 \pm 5°C		Duration	3 \pm 0.5 sec.		Measurement shall be conducted	24 \pm 2hrs under the standard condition Note 5			SD		1005、1608、2012type	3216type	Preheating conditions	80 to 100°C 2 to 5 min 150 to 200°C 2 to 5 min	80 to 100°C 5 to 10 min 150 to 200°C 5 to 10 min	Solder temp.	270 \pm 5°C		Duration	3 \pm 0.5 sec.		Measurement shall be conducted	24 \pm 2hrs under the standard condition Note 5
	LD																																						
	1608、2012type	3216、3225type																																					
Preconditioning	Thermal treatment (at 150°C for 1 hr) Note 2																																						
Preheating conditions	80 to 100°C 2 to 5 min 150 to 200°C 2 to 5 min	80 to 100°C 5 to 10 min 150 to 200°C 5 to 10 min																																					
Solder temp.	270 \pm 5°C																																						
Duration	3 \pm 0.5 sec.																																						
Measurement shall be conducted	24 \pm 2hrs under the standard condition Note 5																																						
	SD																																						
	1005、1608、2012type	3216type																																					
Preheating conditions	80 to 100°C 2 to 5 min 150 to 200°C 2 to 5 min	80 to 100°C 5 to 10 min 150 to 200°C 5 to 10 min																																					
Solder temp.	270 \pm 5°C																																						
Duration	3 \pm 0.5 sec.																																						
Measurement shall be conducted	24 \pm 2hrs under the standard condition Note 5																																						

14. Temperature Cycle (Thermal Shock)

Specified Value	Appearance	: No abnormality																														
	Capacitance change	: Within $\pm 7.5\%$ (LD), Within $\pm 2.5\%$ (SD)																														
Specified Value	Dissipation factor	: Initial value																														
	Insulation resistance	: Initial value																														
Specified Value	Withstanding voltage (between terminals)	: No abnormality																														
	Test Methods and Remarks	<table border="1"> <thead> <tr> <th rowspan="2"></th> <th>LD</th> <th>SD</th> </tr> </thead> <tbody> <tr> <td>Preconditioning</td> <td>Thermal treatment (at 150°C for 1 hr) Note 2</td> <td>None</td> </tr> <tr> <td>1 cycle</td> <td colspan="2"> <table border="1"> <thead> <tr> <th>Step</th> <th>temperature (°C)</th> <th>Time (min.)</th> </tr> </thead> <tbody> <tr> <td>1</td> <td>Minimum operating temperature</td> <td>30 \pm 3 min.</td> </tr> <tr> <td>2</td> <td>Normal temperature</td> <td>2 to 3 min.</td> </tr> <tr> <td>3</td> <td>Maximum operating temperature</td> <td>30 \pm 3 min.</td> </tr> <tr> <td>4</td> <td>Normal temperature</td> <td>2 to 3 min.</td> </tr> </tbody> </table> </td> </tr> <tr> <td>Number of cycles</td> <td colspan="2">5 time</td> </tr> <tr> <td>Measurement shall be conducted</td> <td colspan="2">24 \pm 2hrs under the standard condition Note 5</td> </tr> </tbody> </table>			LD	SD	Preconditioning	Thermal treatment (at 150°C for 1 hr) Note 2	None	1 cycle	<table border="1"> <thead> <tr> <th>Step</th> <th>temperature (°C)</th> <th>Time (min.)</th> </tr> </thead> <tbody> <tr> <td>1</td> <td>Minimum operating temperature</td> <td>30 \pm 3 min.</td> </tr> <tr> <td>2</td> <td>Normal temperature</td> <td>2 to 3 min.</td> </tr> <tr> <td>3</td> <td>Maximum operating temperature</td> <td>30 \pm 3 min.</td> </tr> <tr> <td>4</td> <td>Normal temperature</td> <td>2 to 3 min.</td> </tr> </tbody> </table>		Step	temperature (°C)	Time (min.)	1	Minimum operating temperature	30 \pm 3 min.	2	Normal temperature	2 to 3 min.	3	Maximum operating temperature	30 \pm 3 min.	4	Normal temperature	2 to 3 min.	Number of cycles	5 time		Measurement shall be conducted	24 \pm 2hrs under the standard condition Note 5
	LD	SD																														
	Preconditioning	Thermal treatment (at 150°C for 1 hr) Note 2	None																													
1 cycle	<table border="1"> <thead> <tr> <th>Step</th> <th>temperature (°C)</th> <th>Time (min.)</th> </tr> </thead> <tbody> <tr> <td>1</td> <td>Minimum operating temperature</td> <td>30 \pm 3 min.</td> </tr> <tr> <td>2</td> <td>Normal temperature</td> <td>2 to 3 min.</td> </tr> <tr> <td>3</td> <td>Maximum operating temperature</td> <td>30 \pm 3 min.</td> </tr> <tr> <td>4</td> <td>Normal temperature</td> <td>2 to 3 min.</td> </tr> </tbody> </table>		Step	temperature (°C)	Time (min.)	1	Minimum operating temperature	30 \pm 3 min.	2	Normal temperature	2 to 3 min.	3	Maximum operating temperature	30 \pm 3 min.	4	Normal temperature	2 to 3 min.															
Step	temperature (°C)	Time (min.)																														
1	Minimum operating temperature	30 \pm 3 min.																														
2	Normal temperature	2 to 3 min.																														
3	Maximum operating temperature	30 \pm 3 min.																														
4	Normal temperature	2 to 3 min.																														
Number of cycles	5 time																															
Measurement shall be conducted	24 \pm 2hrs under the standard condition Note 5																															

15. Humidity (Steady state)

Specified Value Note 1	Appearance	: No abnormality																		
	Capacitance change	: Within $\pm 12.5\%$ (LD), $\pm 5\%$ Within(SD)																		
Specified Value	Dissipation factor	: 20%max(LD), 0.5%max(SD)																		
	Insulation resistance	: 50M Ω μ F or 1000M Ω , whichever is smaller																		
Test Methods and Remarks	<table border="1"> <thead> <tr> <th></th> <th>LD</th> <th>SD</th> </tr> </thead> <tbody> <tr> <td>Preconditioning</td> <td>Thermal treatment (at 150°C for 1 hr) Note 2</td> <td>None</td> </tr> <tr> <td>Temperature</td> <td colspan="2">40 \pm 2°C</td> </tr> <tr> <td>Humidity</td> <td colspan="2">90 to 95% RH</td> </tr> <tr> <td>Duration</td> <td colspan="2">500 +24/-0 hrs</td> </tr> <tr> <td>Measurement shall be conducted</td> <td colspan="2">24 \pm 2hrs under the standard condition Note 5</td> </tr> </tbody> </table>			LD	SD	Preconditioning	Thermal treatment (at 150°C for 1 hr) Note 2	None	Temperature	40 \pm 2°C		Humidity	90 to 95% RH		Duration	500 +24/-0 hrs		Measurement shall be conducted	24 \pm 2hrs under the standard condition Note 5	
	LD	SD																		
Preconditioning	Thermal treatment (at 150°C for 1 hr) Note 2	None																		
Temperature	40 \pm 2°C																			
Humidity	90 to 95% RH																			
Duration	500 +24/-0 hrs																			
Measurement shall be conducted	24 \pm 2hrs under the standard condition Note 5																			

▶ This catalog contains the typical specification only due to the limitation of space. When you consider the purchase of our products, please check our specification.
For details of each product (characteristics graph, reliability information, precautions for use, and so on), see our Web site (<http://www.ty-top.com/>).

16. Humidity Loading

Specified Value Note 1	Appearance	: No abnormality	
	Capacitance change	: Within $\pm 12.5\%$ (LD), Within $\pm 7.5\%$ (SD)	
	Dissipation factor	: 20%max (LD), 0.5%max (SD)	
	Insulation resistance	: 25M Ω μ F or 500M Ω , whichever is smaller	
Test Methods and Remarks		LD	SD
	Preconditioning	Voltage treatment (Rated voltage are applied for 1 hour at 40 °C) Note 3	
	Temperature	40 \pm 2°C	
	Humidity	90 to 95% RH	
	Duration	500 +24/−0 hrs	
	Applied voltage	Rated voltage	
	Charge/discharge current	50mA max	
	Measurement shall be conducted	24 \pm 2hrs under the standard condition	
		Note 5	

17. High Temperature Loading

Specified Value Note 1	Appearance	: No abnormality		
	Capacitance change	: Within $\pm 12.5\%$ (LD), Within $\pm 3\%$ (SD)		
	Dissipation factor	: 20%max (LD), 0.35%max (SD)		
	Insulation resistance	: 50M Ω μ F or 1000M Ω , whichever is smaller		
Test Methods and Remarks		LD	SD	
	Preconditioning	Voltage treatment (Twice the rated voltage shall be applied for 1 hour at 85°C or 125°C) Note 3, Note 4		
	Temperature	Maximum operating temperature		
	Duration	1000 +48/−0 hrs		
	Applied voltage	Rated voltage x 2	Note 4	Rated voltage x 2
	Charge/discharge current	50mA max		
	Measurement shall be conducted	24 \pm 2hrs under the standard condition		
		Note 5		

Note 1 The figures indicate typical specifications. Please refer to individual specifications in detail.

Note 2 Thermal treatment : Initial value shall be measured after test sample is heat-treated at 150+0/−10°C for an hour and kept at room temperature for 24 \pm 2hours.

Note 3 Voltage treatment : Initial value shall be measured after test sample is voltage-treated for an hour at both the temperature and voltage specified in the test conditions, and kept at room temperature for 24 \pm 2hours.

Note 4 150% of rated voltage is applicable to some items. Please refer to their specifications for further information.

Note 5 Standard condition: Temperature: 5 to 35°C, Relative humidity: 45 to 85 % RH, Air pressure: 86 to 106kPa When there are questions concerning measurement results, in order to provide correlation data, the test shall be conducted under the following condition.

Temperature: 20 \pm 2°C, Relative humidity: 60 to 70 % RH, Air pressure: 86 to 106kPa Unless otherwise specified, all the tests are conducted under the "standard condition".

Medium-High Voltage Multilayer Ceramic Capacitor for General Electronic Equipment for Consumer
Medium-High Voltage Multilayer Ceramic Capacitor
for Medical Devices classified as GHTF Classes A or B (Japan Classes I or II)

■ RELIABILITY DATA

1. Operating Temperature Range		
Specified Value	Temperature Compensating(Class1)	C0G, C0H : -55 to +125°C
	High Permittivity (Class2)	X7R, X7S : -55 to +125°C X5R : -55 to +85°C B : -25 to +85°C SD : -55 to +125°C
2. Storage Temperature Range		
Specified Value	Temperature Compensating(Class1)	C0G, C0H : -55 to +125°C
	High Permittivity (Class2)	X7R, X7S : -55 to +125°C X5R : -55 to +85°C B : -25 to +85°C SD : -55 to +125°C
3. Rated Voltage		
Specified Value	Temperature Compensating(Class1)	100VDC(Code:H)
	High Permittivity (Class2)	100VDC(Code:H), 250VDC(Code:Q), 630VDC(Code:S), 2000VDC(Code:X)
4. Withstanding Voltage (Between terminals)		
Specified Value	No breakdown or damage	
Test Methods and Remarks	Applied voltage : Rated voltage (H) × 2.5, Rated voltage (Q) × 2, Rated voltage (S, X) × 1.2 Duration : 1 to 5sec. Charge/discharge current : 50mA max.	
5. Insulation Resistance		
Specified Value	Temperature Compensating(Class1)	10000 MΩ min.
	High Permittivity (Class2)	100MΩ · μF or 10GΩ, whichever is smaller.
Test Methods and Remarks	Applied voltage : Rated voltage (H, Q), 500V (S, X) Duration : 60 ± 5sec. Charge/discharge current : 50mA max.	
6. Capacitance (Tolerance)		
Specified Value	Temperature Compensating(Class1)	C ≤ 10pF : ±0.5pF C > 10pF : ±5% (C: Nominal capacitance)
	High Permittivity (Class2)	±10%, ±20%
Test Methods and Remarks	Temperature Compensating(Class1)	Measuring frequency : 1MHz ± 10% Measuring voltage : 0.5~5Vrms Bias application : None
	High Permittivity (Class2)	Measuring frequency : 1kHz ± 10%, 1MHz ± 10% (SD: 1608type(H), 2012type(Q)) Measuring voltage : 1 ± 0.2Vrms Bias application : None

▶ This catalog contains the typical specification only due to the limitation of space. When you consider the purchase of our products, please check our specification.
 For details of each product (characteristics graph, reliability information, precautions for use, and so on), see our Web site (<http://www.ty-top.com/>).

7. Q or Dissipation Factor

Specified Value	Temperature Compensating(Class1)	C < 30pF : Q ≥ 400 + 20C C ≥ 30pF : Q ≥ 1000 (C: Nominal capacitance)
	High Permittivity (Class2)	3.5%max(H: 1608type min), 2.5%max(H: 1005type,Q, S, X), 0.1type max (SD)
Test Methods and Remarks	Temperature Compensating(Class1)	Measuring frequency : 1MHz ± 10% Measuring voltage : 0.5 ~ 5Vrms Bias application : None
	High Permittivity (Class2)	Measuring frequency : 1kHz ± 10%, 1MHz ± 10% (SD:1608type(H), 2012type(Q)) Measuring voltage : 1 ± 0.2Vrms Bias application : None

8. Temperature Characteristic of Capacitance

Specified Value	Temperature Compensating(Class1)	C0G : 0 ± 30ppm/°C (-55 to +125°C) C0H : 0 ± 60ppm/°C (-55 ~ +125°C)											
	High Permittivity (Class2)	B : ± 10% (-25 to +85°C) X5R : ± 15% (-55 to +85°C) X7R : ± 15% (-55 to +125°C) X7S : ± 22% (-55 to +125°C)											
Test Methods and Remarks	<p>Class 1 Capacitance at 20°C and 85°C shall be measured in thermal equilibrium, and the temperature characteristic shall be calculated from the following equation.</p> $\frac{(C_{85} - C_{20})}{C_{20} \times \Delta T} \times 10^6 \text{ (ppm/°C)} \quad \Delta T = 65$												
	<p>Class 2 Capacitance at each step shall be measured in thermal equilibrium, and the temperature characteristic shall be calculated from the following equation.</p> <table border="1" style="margin-left: 20px;"> <thead> <tr> <th>Step</th> <th>B</th> <th>X5R, X7R, X7S</th> </tr> </thead> <tbody> <tr> <td>1</td> <td colspan="2">Minimum operating temperature</td> </tr> <tr> <td>2</td> <td>20°C</td> <td>25°C</td> </tr> <tr> <td>3</td> <td colspan="2">Maximum operating temperature</td> </tr> </tbody> </table> $\frac{(C - C_2)}{C_2} \times 100 \text{ (%)}$ <p>C : Capacitance value in Step 1 or Step 3 C2 : Capacitance value in Step 2</p>		Step	B	X5R, X7R, X7S	1	Minimum operating temperature		2	20°C	25°C	3	Maximum operating temperature
Step	B	X5R, X7R, X7S											
1	Minimum operating temperature												
2	20°C	25°C											
3	Maximum operating temperature												

9. Deflection

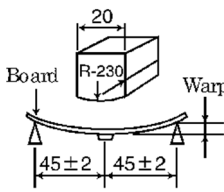
Specified Value	Temperature Compensating(Class1)	Appearance : No abnormality Capacitance change : Within ± 5% or ± 0.5 pF, whichever is larger.
	High Permittivity (Class2)	Appearance : No abnormality Capacitance change : ± 10%, ± 5%, (SD)
Test Methods and Remarks	<p>Warp : 1mm Duration : 10sec. Test board : Glass epoxy-resin substrate Thickness : 1.6mm</p>	 <p style="text-align: center;">(Unit: mm)</p>
	Capacitance measurement shall be conducted with the board bent.	

10. Adhesive Strength of Terminal Electrodes

Specified Value	Temperature Compensating(Class1)	No terminal separation or its indication.
	High Permittivity (Class2)	
Test Methods and Remarks	Applied force : 5N	
	Duration : 30 ± 5sec.	

11. Vibration

Specified Value	Temperature Compensating(Class1)	Initial performance shall be satisfied.
	High Permittivity (Class2)	
Test Methods and Remarks	Preconditioning : Thermal treatment(at 150°C for 1hr) Note1 (Only High permittivity) Frequency range : 10 to 55 Hz Overall amplitude : 1.5 mm Sweeping method : 10 to 55 to 10 Hz for 1 min Two hours each in X, Y, Z directions: 6 hrs in total	

12. Solderability

Specified Value	Temperature Compensating(Class1)	At least 95% of terminal electrode is covered by new solder	
	High Permittivity (Class2)		
Test Methods and Remarks		Eutectic solder	Lead-free solder
	Solder type	H60A or H63A	Sn-3.0Ag-0.5Cu
	Solder temperature	230±5°C	245±3°C
	Duration	4±1 sec.	

13. Resistance to Soldering

Specified Value	Temperature Compensating(Class1)	Appearance : No abnormality Capacitance change : Within ±2.5% or ±0.25pF, whichever is larger. Q : Initial value Insulation resistance : Initial value Withstanding voltage (between terminals) : No abnormality
	High Permittivity (Class2)	Appearance : No abnormality Capacitance change : Within±7.5%(H: 1005type), ±15%(H: 1608type min) ±10%(Q, S, X), ±2.5%(SD) Dissipation facto : Initial value Insulation resistance : Initial value Withstanding voltage (between terminals) : No abnormality
Test Methods and Remarks	Temperature Compensating(Class1)	
	Preconditioning	None
	Solder temperature	270±5°C
	Duration	3±0.5sec.
	Preheating conditions	80 to 100°C, 2 to 5 min. 150 to 200°C, 2 to 5min.
	Recovery	24±2hrs under the standard condition Note3
	High Permittivity (Class2)	
	Preconditioning	Thermal treatment(at 150°C for 1hr) Note1
	Solder temperature	270±5°C
	Duration	3±0.5sec.
	Preheating conditions	80 to 100°C, 2 to 5 min.(2012type max), 5 to 10 min(3216type min) 150 to 200°C, 2 to 5min.(2012type max), 5 to 10 min(3216type min)
	Recovery	24±2hrs under the standard condition Note3

► This catalog contains the typical specification only due to the limitation of space. When you consider the purchase of our products, please check our specification. For details of each product (characteristics graph, reliability information, precautions for use, and so on), see our Web site (<http://www.ty-top.com/>).

14. Temperature Cycle (Thermal Shock)

Specified Value	Temperature Compensating(Class1)	Appearance : No abnormality Capacitance change : Within $\pm 2.5\%$ or $\pm 0.25\text{pF}$, whichever is larger. Q : Initial value Insulation resistance : Initial value Withstanding voltage (between terminals) : No abnormality	
	High Permittivity (Class2)	Appearance : No abnormality Capacitance change : Within $\pm 7.5\%$ (H: 1005type), $\pm 15\%$ (H: 1608type min) $\pm 10\%$ (Q, S, X), $\pm 2.5\%$ (SD) Dissipation facto : Initial value Insulation resistance : Initial value Withstanding voltage (between terminals) : No abnormality	
Test Methods and Remarks	Class 1		
	Class 2		
	Preconditioning	None	
	Thermal treatment (at 150°C for 1 hr) Note 1		
	1 cycle	Step	Temperature (°C)
		1	Minimum operating temperature
2		Normal temperature	
3		Maximum operating temperature	
4	Normal temperature		
Number of cycles	5 times		
Recovery	24 \pm 2 hrs (Standard condition) Note 3		

15. Humidity (Steady state)

Specified Value	Temperature Compensating(Class1)	Appearance : No abnormality Capacitance change : Within $\pm 5\%$ or $\pm 0.5\text{pF}$, whichever is larger. Q : $C < 10\text{pF} : Q \geq 200 + 10C$ $10 \leq C < 30\text{pF} : Q \geq 275 + 2.5C$ $C \geq 30\text{pF} : Q \geq 350$ (C:Nominal capacitance) Insulation resistance : 1000 M Ω min.
	High Permittivity (Class2)	Appearance : No abnormality Capacitance change : $\pm 12.5\%$ max(1005type), $\pm 15\%$ max(1608type min), $\pm 5\%$ max(SD) Dissipation factor : 5%max(H: 1005type,Q, S, X), 7%max(H: 1608type min), 0.5%max(SD). Insulation resistance : 25M Ω μ F or 1000M Ω , whichever is smaller.
Test Methods and Remarks	Preconditioning	: Thermal treatment(at 150°C for 1hr) Note1 (Only High permittivity)
	Temperature	: 40 \pm 2°C
	Humidity	: 90 to 95%RH
	Duration	: 500 +24/−0 hrs
	Recovery	: 24 \pm 2hrs under the standard condition Note3

16. Humidity Loading

Specified Value	Temperature Compensating(Class1)	Appearance : No abnormality Capacitance change : Within $\pm 7.5\%$ or $\pm 0.75\text{pF}$, whichever is larger Q : $C < 30\text{pF} : Q \geq 100 + 10C/3$ $C \geq 30\text{pF} : Q \geq 200$ (C:Nominal capacitance) Insulation resistance : 500 M Ω min.
	High Permittivity (Class2)	Appearance : No abnormality Capacitance change : $\pm 12.5\%$ max(1005type), $\pm 15\%$ max(1608type min), $\pm 7.5\%$ max(SD) Dissipation factor : 5%max(H: 1005type,Q, S, X), 7%max(H: 1608type min), 0.5%max(SD) Insulation resistance : 10M Ω μ F or 500M Ω , whichever is smaller.
Test Methods and Remarks	Preconditioning	: Voltage treatment(Rated voltage are applied for 1 hour at 40°C)Note 2 (Only High permittivity)
	Temperature	: 40 \pm 2°C
	Humidity	: 90 to 95%RH
	Duration	: 500 +24/−0 hrs
	Applied voltage	: Rated voltage
	Charge/discharge current	: 50mA max.
	Recovery	: 24 \pm 2hrs under the standard condition Note3

► This catalog contains the typical specification only due to the limitation of space. When you consider the purchase of our products, please check our specification. For details of each product (characteristics graph, reliability information, precautions for use, and so on), see our Web site (<http://www.ty-top.com/>).

17. High Temperature Loading

Specified Value	Temperature Compensating(Class1)	Appearance : No abnormality Capacitance change : Within $\pm 3\%$ or $\pm 0.3\text{pF}$, whichever is larger Q : $C < 10\text{pF}$: $Q \geq 200 + 10C$ $10 \leq C < 30\text{pF}$: $Q \geq 275 + 2.5C$ $C \geq 30\text{pF}$: $Q \geq 350$ (C:Nominal capacitance) Insulation resistance : $1000 \text{ M}\Omega$ min.
	High Permittivity (Class2)	Appearance : No abnormality Capacitance change : $\pm 12.5\% \text{max}(1005\text{type})$, $\pm 15\% \text{max}(1608\text{type min})$, $\pm 3\% \text{max}(SD)$ Dissipation factor : $5\% \text{max}(H: 1005\text{type}, Q, S, X)$, $7\% \text{max}(H: 1608\text{type min})$, $0.35\% \text{max}(SD)$ Insulation resistance : $50 \text{ M}\Omega \mu\text{F}$ or $1000 \text{ M}\Omega$, whichever is smaller.
Test Methods and Remarks	Preconditioning : Voltage treatment(Twice the rated voltage shall be applied for 1 hour at 85°C or 125°C) Note 2 (Only High permittivity) Temperature : Maximum operating temperature Duration : $1000 + 24/-0$ hrs Applied voltage : Rated voltage(H) $\times 2$, Rated voltage(Q) $\times 1.5$, Rated voltage $\times 1.2$ (S, X) $\times 1.2$ Charge/discharge current : 50mA max. Recovery : 24 ± 2 hrs under the standard condition Note3	
Note1 Thermal treatment : Initial value shall be measured after test sample is heat-treated at $150 \pm 0/-10^\circ\text{C}$ for an hour and kept at room temperature for 24 ± 2 hours. Note2 Voltage treatment : Initial value shall be measured after test sample is voltage-treated for an hour at both the temperature and voltage specified in the test conditions, and kept at room temperature for 24 ± 2 hours. Note3 Standard condition : Temperature: 5 to 35°C , Relative humidity: 45 to 85% RH, Air pressure: 86 to 106kPa When there are questions concerning measurement results, in order to provide correlation data, the test shall be conducted under the following condition. Temperature: $20 \pm 2^\circ\text{C}$, Relative humidity: 60 to 70% RH, Air pressure: 86 to 106kPa Unless otherwise specified, all the tests are conducted under the "standard condition".		

Multilayer Ceramic Capacitors

PRECAUTIONS

1. Circuit Design

- Precautions**
- ◆ Verification of operating environment, electrical rating and performance
 1. A malfunction of equipment in fields such as medical, aerospace, nuclear control, etc. may cause serious harm to human life or have severe social ramifications. Therefore, any capacitors to be used in such equipment may require higher safety and reliability, and shall be clearly differentiated from them used in general purpose applications.
 - ◆ Operating Voltage (Verification of Rated voltage)
 1. The operating voltage for capacitors must always be their rated voltage or less.
 - If an AC voltage is loaded on a DC voltage, the sum of the two peak voltages shall be the rated voltage or less.
 - For a circuit where an AC or a pulse voltage may be used, the sum of their peak voltages shall also be the rated voltage or less.
 2. Even if an applied voltage is the rated voltage or less reliability of capacitors may be deteriorated in case that either a high frequency AC voltage or a pulse voltage having rapid rise time is used in a circuit.

2. PCB Design

- Precautions**
- ◆ Pattern configurations (Design of Land-patterns)
 1. When capacitors are mounted on PCBs, the amount of solder used (size of fillet) can directly affect the capacitor performance. Therefore, the following items must be carefully considered in the design of land patterns:
 - (1) Excessive solder applied can cause mechanical stresses which lead to chip breaking or cracking. Therefore, please consider appropriate land-patterns for proper amount of solder.
 - (2) When more than one component are jointly soldered onto the same land, each component's soldering point shall be separated by solder-resist.
 - ◆ Pattern configurations (Capacitor layout on PCBs)

After capacitors are mounted on boards, they can be subjected to mechanical stresses in subsequent manufacturing processes (PCB cutting, board inspection, mounting of additional parts, assembly into the chassis, wave soldering of the boards, etc.). For this reason, land pattern configurations and positions of capacitors shall be carefully considered to minimize stresses.

Technical considerations

- ◆ Pattern configurations (Design of Land-patterns)

The following diagrams and tables show some examples of recommended land patterns to prevent excessive solder amounts.

(1) Recommended land dimensions for typical chip capacitors

 - Multilayer Ceramic Capacitors : Recommended land dimensions (unit: mm)

Wave-soldering

Type	1608	2012	3216	3225	
Size	L	1.6	2.0	3.2	3.2
	W	0.8	1.25	1.6	2.5
A	0.8 to 1.0	1.0 to 1.4	1.8 to 2.5	1.8 to 2.5	
B	0.5 to 0.8	0.8 to 1.5	0.8 to 1.7	0.8 to 1.7	
C	0.6 to 0.8	0.9 to 1.2	1.2 to 1.6	1.8 to 2.5	

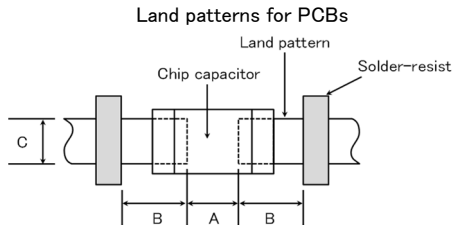

Reflow-soldering

Type	0201	0402	0603	1005	1608	2012	3216	3225	4532
Size	L	0.25	0.4	0.6	1.0	1.6	2.0	3.2	4.5
	W	0.125	0.2	0.3	0.5	0.8	1.25	1.6	3.2
A	0.095~0.135	0.15~0.25	0.20~0.30	0.45~0.55	0.6~0.8	0.8~1.2	1.8~2.5	1.8~2.5	2.5~3.5
B	0.085~0.125	0.10~0.20	0.20~0.30	0.40~0.50	0.6~0.8	0.8~1.2	1.0~1.5	1.0~1.5	1.5~1.8
C	0.110~0.150	0.15~0.30	0.25~0.40	0.45~0.55	0.6~0.8	0.9~1.6	1.2~2.0	1.8~3.2	2.3~3.5

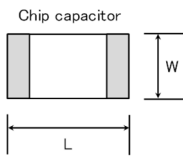

Note: Recommended land size might be different according to the allowance of the size of the product.

 - LWDC: Recommended land dimensions for reflow-soldering (unit: mm)

Type	0510	0816	1220	
Size	L	0.52	0.8	1.25
	W	1.0	1.6	2.0
A	0.18~0.22	0.25~0.3	0.5~0.7	
B	0.2~0.25	0.3~0.4	0.4~0.5	
C	0.9~1.1	1.5~1.7	1.9~2.1	

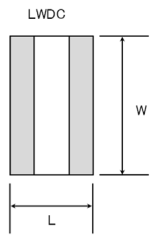

* This catalog contains the typical specification only due to the limitation of space. When you consider the purchase of our products, please check our specification. For details of each product (characteristics graph, reliability information, precautions for use, and so on), see our Web site (<http://www.ty-top.com/>).

(2) Examples of good and bad solder application

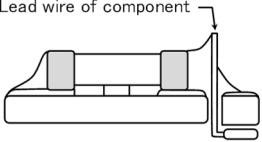
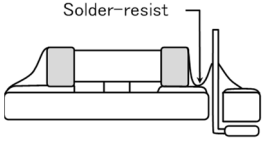
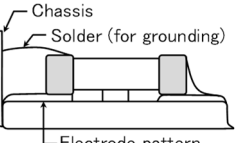
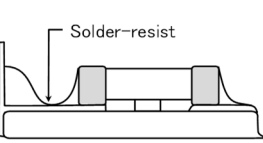
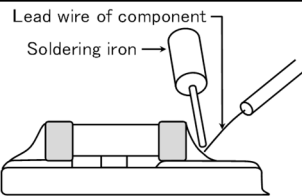
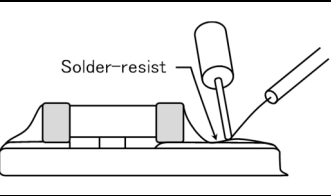
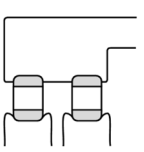
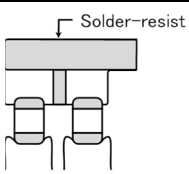
Item	Not recommended	Recommended
Mixed mounting of SMD and leaded components		
Component placement close to the chassis		
Hand-soldering of leaded components near mounted components		
Horizontal component placement		

◆ Pattern configurations (Capacitor layout on PCBs)

1-1. The following is examples of good and bad capacitor layouts ; capacitors shall be located to minimize any possible mechanical stresses from board warp or deflection.

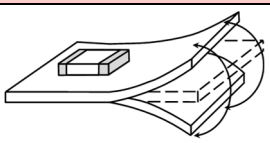
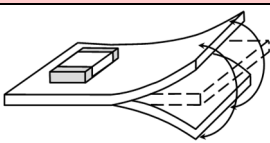
Items	Not recommended	Recommended
Deflection of board		 Place the product at a right angle to the direction of the anticipated mechanical stress.

1-2. The amount of mechanical stresses given will vary depending on capacitor layout. Please refer to diagram below.

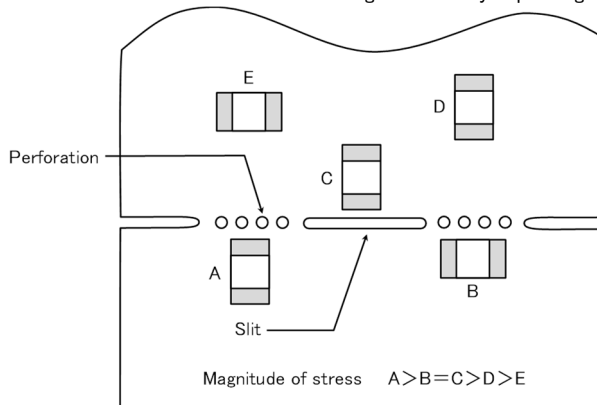

1-3. When PCB is split, the amount of mechanical stress on the capacitors can vary according to the method used. The following methods are listed in order from least stressful to most stressful: push-back, slit, V-grooving, and perforation. Thus, please consider the PCB, split methods as well as chip location.

3. Mounting

Precautions

◆ Adjustment of mounting machine

- When capacitors are mounted on PCB, excessive impact load shall not be imposed on them.
- Maintenance and inspection of mounting machines shall be conducted periodically.

◆ Selection of Adhesives

- When chips are attached on PCBs with adhesives prior to soldering, it may cause capacitor characteristics degradation unless the following factors are appropriately checked : size of land patterns, type of adhesive, amount applied, hardening temperature and hardening period. Therefore, please contact us for further information.

◆ Adjustment of mounting machine

1. When the bottom dead center of a pick-up nozzle is too low, excessive force is imposed on capacitors and causes damages. To avoid this, the following points shall be considerable.
 - (1) The bottom dead center of the pick-up nozzle shall be adjusted to the surface level of PCB without the board deflection.
 - (2) The pressure of nozzle shall be adjusted between 1 and 3 N static loads.
 - (3) To reduce the amount of deflection of the board caused by impact of the pick-up nozzle, supporting pins or back-up pins shall be used on the other side of the PCB. The following diagrams show some typical examples of good and bad pick-up nozzle placement:

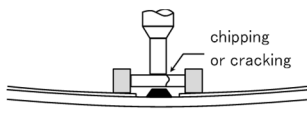
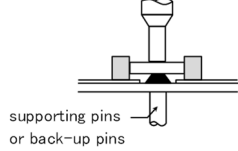
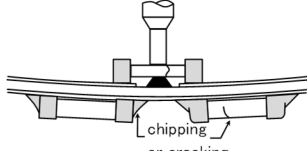
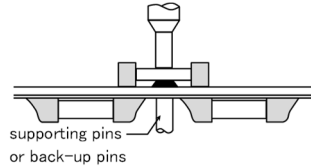
Item	Improper method	Proper method
Single-sided mounting		
Double-sided mounting		

Technical considerations

2. As the alignment pin is worn out, adjustment of the nozzle height can cause chipping or cracking of capacitors because of mechanical impact on the capacitors. To avoid this, the monitoring of the width between the alignment pins in the stopped position, maintenance, check and replacement of the pin shall be conducted periodically.

◆ Selection of Adhesives

Some adhesives may cause IR deterioration. The different shrinkage percentage of between the adhesive and the capacitors may result in stresses on the capacitors and lead to cracking. Moreover, too little or too much adhesive applied to the board may adversely affect components. Therefore, the following precautions shall be noted in the application of adhesives.

- (1) Required adhesive characteristics
 - a. The adhesive shall be strong enough to hold parts on the board during the mounting & solder process.
 - b. The adhesive shall have sufficient strength at high temperatures.
 - c. The adhesive shall have good coating and thickness consistency.
 - d. The adhesive shall be used during its prescribed shelf life.
 - e. The adhesive shall harden rapidly.
 - f. The adhesive shall have corrosion resistance.
 - g. The adhesive shall have excellent insulation characteristics.
 - h. The adhesive shall have no emission of toxic gasses and no effect on the human body.
- (2) The recommended amount of adhesives is as follows:

[Recommended condition]

Figure	2012/3216 case sizes as examples
a	0.3mm min
b	100 to 120 μm
c	Adhesives shall not contact land

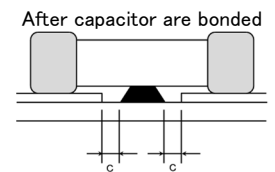
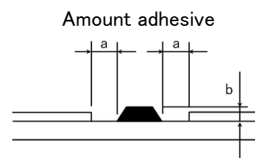

4. Soldering

◆ Selection of Flux

- Since flux may have a significant effect on the performance of capacitors, it is necessary to verify the following conditions prior to use;
- (1) Flux used shall be less than or equal to 0.1 wt% (in Cl equivalent) of halogenated content. Flux having a strong acidity content shall not be applied.
 - (2) When shall capacitors are soldered on boards, the amount of flux applied shall be controlled at the optimum level.
 - (3) When water-soluble flux is used, special care shall be taken to properly clean the boards.

Precautions

◆ Soldering

Temperature, time, amount of solder, etc. shall be set in accordance with their recommended conditions. Sn-Zn solder paste can adversely affect MLCC reliability. Please contact us prior to usage of Sn-Zn solder.

◆ Selection of Flux

- 1-1. When too much halogenated substance (Chlorine, etc.) content is used to activate flux, or highly acidic flux is used, it may lead to corrosion of terminal electrodes or degradation of insulation resistance on the surfaces of the capacitors.
- 1-2. Flux is used to increase solderability in wave soldering. However if too much flux is applied, a large amount of flux gas may be emitted and may adversely affect the solderability. To minimize the amount of flux applied, it is recommended to use a flux-bubbling system.
- 1-3. Since the residue of water-soluble flux is easily dissolved in moisture in the air, the residues on the surfaces of capacitors in high humidity conditions may cause a degradation of insulation resistance and reliability of the capacitors. Therefore, the cleaning methods

Technical considerations

▶ This catalog contains the typical specification only due to the limitation of space. When you consider the purchase of our products, please check our specification. For details of each product (characteristics graph, reliability information, precautions for use, and so on), see our Web site (<http://www.ty-top.com/>).

and the capability of the machines used shall also be considered carefully when water-soluble flux is used.

◆Soldering

- Ceramic chip capacitors are susceptible to thermal shock when exposed to rapid or concentrated heating or rapid cooling.
- Therefore, the soldering must be conducted with great care so as to prevent malfunction of the components due to excessive thermal shock.
- Preheating : Capacitors shall be preheated sufficiently, and the temperature difference between the capacitors and solder shall be within 130°C.
- Cooling : The temperature difference between the capacitors and cleaning process shall not be greater than 100°C.

[Reflow soldering]

【Recommended conditions for eutectic soldering】

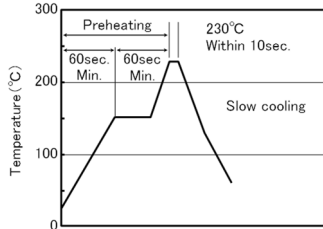

【Recommended condition for Pb-free soldering】

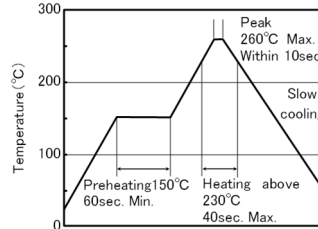

Caution

- ①The ideal condition is to have solder mass (fillet) controlled to 1/2 to 1/3 of the thickness of a capacitor.
- ②Because excessive dwell times can adversely affect solderability, soldering duration shall be kept as close to recommended times as possible. soldering for 2 times.

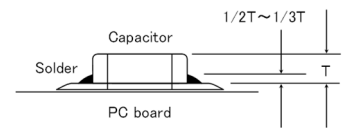

[Wave soldering]

【Recommended conditions for eutectic soldering】

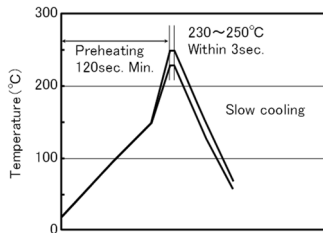

【Recommended condition for Pb-free soldering】

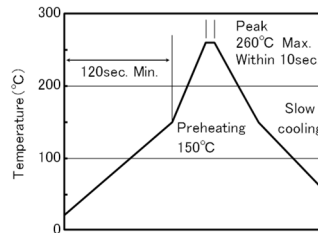

Caution

- ①Wave soldering must not be applied to capacitors designated as for reflow soldering only. soldering for 1 times.

[Hand soldering]

【Recommended conditions for eutectic soldering】

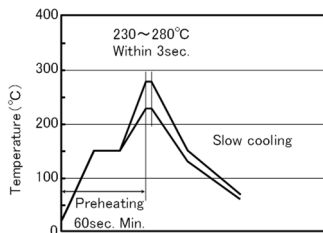

【Recommended condition for Pb-free soldering】

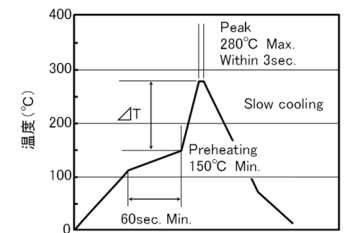
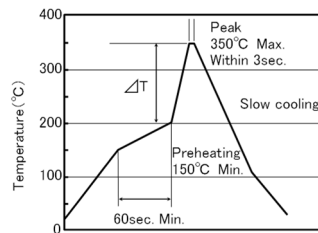

	ΔT
3216type or less	$\Delta T \leq 150^{\circ}\text{C}$

	ΔT
3225type or more	$\Delta T \leq 130^{\circ}\text{C}$

Caution

- ①Use a 50W soldering iron with a maximum tip diameter of 1.0 mm.
- ②The soldering iron shall not directly touch capacitors. soldering for 1 times.

► This catalog contains the typical specification only due to the limitation of space. When you consider the purchase of our products, please check our specification. For details of each product (characteristics graph, reliability information, precautions for use, and so on), see our Web site (<http://www.ty-top.com/>).

5. Cleaning	
Precautions	<p>◆Cleaning conditions</p> <ol style="list-style-type: none"> When PCBs are cleaned after capacitors mounting, please select the appropriate cleaning solution in accordance with the intended use of the cleaning. (e.g. to remove soldering flux or other materials from the production process.) Cleaning condition shall be determined after it is verified by using actual cleaning machine that the cleaning process does not affect capacitor's characteristics.
Technical considerations	<ol style="list-style-type: none"> The use of inappropriate cleaning solutions can cause foreign substances such as flux residue to adhere to capacitors or deteriorate their outer coating, resulting in a degradation of the capacitor's electrical properties (especially insulation resistance). Inappropriate cleaning conditions (insufficient or excessive cleaning) may adversely affect the performance of the capacitors. In the case of ultrasonic cleaning, too much power output can cause excessive vibration of PCBs which may lead to the cracking of capacitors or the soldered portion, or decrease the terminal electrodes' strength. Therefore, the following conditions shall be carefully checked: Ultrasonic output : 20 W/l or less Ultrasonic frequency : 40 kHz or less Ultrasonic washing period : 5 min. or less

6. Resin coating and mold	
Precautions	<ol style="list-style-type: none"> With some type of resins, decomposition gas or chemical reaction vapor may remain inside the resin during the hardening period or while left under normal storage conditions resulting in the deterioration of the capacitor's performance. When a resin's hardening temperature is higher than capacitor's operating temperature, the stresses generated by the excessive heat may lead to damage or destruction of capacitors. The use of such resins, molding materials etc. is not recommended.

7. Handling	
Precautions	<p>◆Splitting of PCB</p> <ol style="list-style-type: none"> When PCBs are split after components mounting, care shall be taken so as not to give any stresses of deflection or twisting to the board. Board separation shall not be done manually, but by using the appropriate devices. <p>◆Mechanical considerations</p> <p>Be careful not to subject capacitors to excessive mechanical shocks.</p> <ol style="list-style-type: none"> If ceramic capacitors are dropped onto a floor or a hard surface, they shall not be used. Please be careful that the mounted components do not come in contact with or bump against other boards or components.

8. Storage conditions	
Precautions	<p>◆Storage</p> <ol style="list-style-type: none"> To maintain the solderability of terminal electrodes and to keep packaging materials in good condition, care must be taken to control temperature and humidity in the storage area. Humidity should especially be kept as low as possible. <ul style="list-style-type: none"> Recommended conditions Ambient temperature : Below 30°C Humidity : Below 70% RH The ambient temperature must be kept below 40°C. Even under ideal storage conditions, solderability of capacitor is deteriorated as time passes, so capacitors shall be used within 6 months from the time of delivery. <ul style="list-style-type: none"> Ceramic chip capacitors shall be kept where no chlorine or sulfur exists in the air. The capacitance values of high dielectric constant capacitors will gradually decrease with the passage of time, so care shall be taken to design circuits. Even if capacitance value decreases as time passes, it will get back to the initial value by a heat treatment at 150°C for 1hour.
Technical considerations	<p>If capacitors are stored in a high temperature and humidity environment, it might rapidly cause poor solderability due to terminal oxidation and quality loss of taping/packaging materials. For this reason, capacitors shall be used within 6 months from the time of delivery. If exceeding the above period, please check solderability before using the capacitors.</p>

※RCR-2335B (Safety Application Guide for fixed ceramic capacitors for use in electronic equipment) is published by JEITA.

Please check the guide regarding precautions for deflection test, soldering by spot heat, and so on.

X-ON Electronics

Largest Supplier of Electrical and Electronic Components

Click to view similar products for [Multilayer Ceramic Capacitors MLCC - SMD/SMT category](#):

Click to view products by [Taiyo Yuden manufacturer](#):

Other Similar products are found below :

[M39014/02-1218V](#) [M39014/02-1225V](#) [M39014/22-0631](#) [D55342E07B523DR-T/R](#) [NIN-FB391JTRF](#) [NIN-FC2R7JTRF](#)
[NMC0402NPO220J50TRPF](#) [NMC0402X5R105K6.3TRPF](#) [NMC0402X5R224K6.3TRPF](#) [NMC0402X7R103J25TRPF](#)
[NMC0402X7R153K16TRPF](#) [NMC0603NPO101F50TRPF](#) [NMC0603NPO1R8C50TRPF](#) [NMC0603NPO201J50TRPF](#)
[NMC0603NPO331F50TRPF](#) [NMC0603X5R475M6.3TRPF](#) [NMC0805NPO270J50TRPF](#) [NMC0805NPO681F50TRPF](#)
[NMC0805NPO820J50TRPF](#) [NMC0805X7R224K16TRPLPF](#) [NMC0805X7R224K25TRPF](#) [NMC1206X7R102K50TRPF](#)
[NMC1206X7R106K10TRPLPF](#) [NMC1206X7R475K10TRPLPF](#) [NMC-H0805X7R472K250TRPF](#) [NMC-L0402NPO7R0C50TRPF](#) [NMC-](#)
[L0603NPO2R2B50TRPF](#) [NMC-Q0402NPO8R2D200TRPF](#) [C1206C101J1GAC](#) [C1608C0G2A221J](#) [C1608X7R1E334K](#) [C2012C0G2A472J](#)
[2220J2K00562KXT](#) [1812J2K00332KXT](#) [CDR31BX103AKWR](#) [CDR33BX104AKUR](#) [CDR33BX683AKUS](#) [CGA2B2C0G1H010C](#)
[CGA2B2C0G1H040C](#) [CGA2B2C0G1H050C](#) [CGA2B2C0G1H060D](#) [CGA2B2C0G1H070D](#) [CGA2B2C0G1H120J](#) [CGA2B2C0G1H151J](#)
[CGA2B2C0G1H1R5C](#) [CGA2B2C0G1H2R2C](#) [CGA2B2C0G1H390J](#) [CGA2B2C0G1H391J](#) [CGA2B2C0G1H3R3C](#) [CGA2B2C0G1H680J](#)