

Notice for TAIYO YUDEN Products[For High Quality and/or Reliability Equipment
(Automotive Electronic Equipment / Industrial Equipment)]

Please read this notice before using the TAIYO YUDEN products.

 **REMINDERS**

- Product information in this catalog is as of October 2018. All of the contents specified herein are subject to change without notice due to technical improvements, etc. Therefore, please check for the latest information carefully before practical application or use of our products.

Please note that TAIYO YUDEN shall not be in any way responsible for any damages and defects in products or equipment incorporating our products, which are caused under the conditions other than those specified in this catalog or individual product specification sheets.

- Please contact TAIYO YUDEN for further details of product specifications as the individual product specification sheets are available.
- Please conduct validation and verification of our products in actual condition of mounting and operating environment before using our products.
- The products listed in this catalog are intended for use in general electronic equipment (e.g., AV equipment, OA equipment, home electric appliances, office equipment, information and communication equipment), medical equipment classified as Class I or II by IMDRF, industrial equipment, and automotive interior applications, etc. Please be sure to contact TAIYO YUDEN for further information before using the products for any equipment which may directly cause loss of human life or bodily injury (e.g., transportation equipment including, without limitation, automotive powertrain control system, train control system, and ship control system, traffic signal equipment, medical equipment classified as Class III by IMDRF).

Please do not incorporate our products into any equipment requiring high levels of safety and/or reliability (e.g., aerospace equipment, aviation equipment*, medical equipment classified as Class IV by IMDRF, nuclear control equipment, undersea equipment, military equipment).

*Note: There is a possibility that our products can be used only for aviation equipment that does not directly affect the safe operation of aircraft (e.g., in-flight entertainment, cabin light, electric seat, cooking equipment) if such use meets requirements specified separately by TAIYO YUDEN. Please be sure to contact TAIYO YUDEN for further information before using our products for such aviation equipment.

When our products are used even for high safety and/or reliability-required devices or circuits of general electronic equipment, it is strongly recommended to perform a thorough safety evaluation prior to use of our products and to install a protection circuit as necessary.

Please note that unless you obtain prior written consent of TAIYO YUDEN, TAIYO YUDEN shall not be in any way responsible for any damages incurred by you or third parties arising from use of the products listed in this catalog for any equipment requiring inquiry to TAIYO YUDEN or prohibited for use by TAIYO YUDEN as described above.

- Information contained in this catalog is intended to convey examples of typical performances and/or applications of our products and is not intended to make any warranty with respect to the intellectual property rights or any other related rights of TAIYO YUDEN or any third parties nor grant any license under such rights.
- Please note that the scope of warranty for our products is limited to the delivered our products themselves and TAIYO YUDEN shall not be in any way responsible for any damages resulting from a fault or defect in our products. Notwithstanding the foregoing, if there is a written agreement (e.g., supply and purchase agreement, quality assurance agreement) signed by TAIYO YUDEN and your company, TAIYO YUDEN will warrant our products in accordance with such agreement.
- The contents of this catalog are applicable to our products which are purchased from our sales offices or authorized distributors (hereinafter "TAIYO YUDEN's official sales channel"). Please note that the contents of this catalog are not applicable to our products purchased from any seller other than TAIYO YUDEN's official sales channel.

- **Caution for Export**

Some of our products listed in this catalog may require specific procedures for export according to "U.S. Export Administration Regulations", "Foreign Exchange and Foreign Trade Control Law" of Japan, and other applicable regulations. Should you have any questions on this matter, please contact our sales staff.

Automotive Application Guide

We classify automotive electronic equipment into the following four application categories and set usable application categories for each of our products. When using our products for automotive electronic equipment, please be sure to check such application categories and use our products accordingly. Should you have any questions on this matter, please contact us.

Category	Automotive Electronic Equipment (Typical Example)
POWERTRAIN	<ul style="list-style-type: none"> • Engine ECU (Electronically Controlled Fuel Injector) • Cruise Control Unit • 4WS (4 Wheel Steering) • Automatic Transmission • Power Steering • HEV/PHV/EV Core Control (Battery, Inverter, DC-DC) • Automotive Locator (Car location information providing device), etc.
SAFETY	<ul style="list-style-type: none"> • ABS (Anti-Lock Brake System) • ESC (Electronic Stability Control) • Airbag • ADAS (Equipment that directly controls running, turning and stopping), etc.
BODY & CHASSIS	<ul style="list-style-type: none"> • Wiper • Automatic Door • Power Window • Keyless Entry System • Electric Door Mirror • Interior Lighting • LED Headlight • TPMS (Tire Pressure Monitoring System) • Anti-Theft Device (Immobilizer), etc.
INFOTAINMENT	<ul style="list-style-type: none"> • Car Infotainment System • ITS/Telematics System • Instrument Cluster • ADAS (Sensor, Equipment that is not interlocked with safety equipment or powertrain), etc.

SMD POWER INDUCTORS(NR SERIES H TYPE/S TYPE/V TYPE)



REFLOW

AEC-Q200

AEC-Q200 Grade 3 (we conduct the evaluation at the test condition of Grade 3.)

*Operating environment Temp:-40~85°C

■ PART NUMBER

*Operating Temp. : -40~125°C (Including self-generated heat)

N	R	S	4	0	1	8	T	△	1	0	0	M	D	G	V	V
①			②				③		④			⑤	⑥			⑦

△ = Blank space

① Series name

Code	Series name
NRH	Coating resin specification
NRS	
NRV	

② Dimensions (L × W × H)

Code	Dimensions (L × W × H) [mm]
2010	2.0 × 2.0 × 1.0
2012	2.0 × 2.0 × 1.2
2410	2.4 × 2.4 × 1.0
2412	2.4 × 2.4 × 1.2
3010	3.0 × 3.0 × 1.0
3012	3.0 × 3.0 × 1.2
3015	3.0 × 3.0 × 1.5
4010	4.0 × 4.0 × 1.0
4012	4.0 × 4.0 × 1.2
4018	4.0 × 4.0 × 1.8
5010	4.9 × 4.9 × 1.0
5012	4.9 × 4.9 × 1.2
5014	4.9 × 4.9 × 1.4
5020	4.9 × 4.9 × 2.0
5024	4.9 × 4.9 × 2.4
5030	4.9 × 4.9 × 3.0
5040	4.9 × 4.9 × 4.0
6010	6.0 × 6.0 × 1.0
6012	6.0 × 6.0 × 1.2
6014	6.0 × 6.0 × 1.4
6020	6.0 × 6.0 × 2.0
6028	6.0 × 6.0 × 2.8
6045	6.0 × 6.0 × 4.5
8030	8.0 × 8.0 × 3.0
8040	8.0 × 8.0 × 4.0

③ Packaging

Code	Packaging
T△	Taping

④ Nominal inductance

Code (example)	Nominal inductance [μH]
2R2	2.2
100	10
101	100

※R=Decimal point

⑤ Inductance tolerance

Code	Inductance tolerance
M	±20%
N	±30%

⑥ Special code

⑦ Internal code

Code	Internal code
V	Inductor for Industrial and Automotive

▶ This catalog contains the typical specification only due to the limitation of space. When you consider the purchase of our products, please check our product specification sheets. For details of each product (characteristics graph, reliability information, precautions for use, and so on), see our website (<http://www.ty-top.com/>).

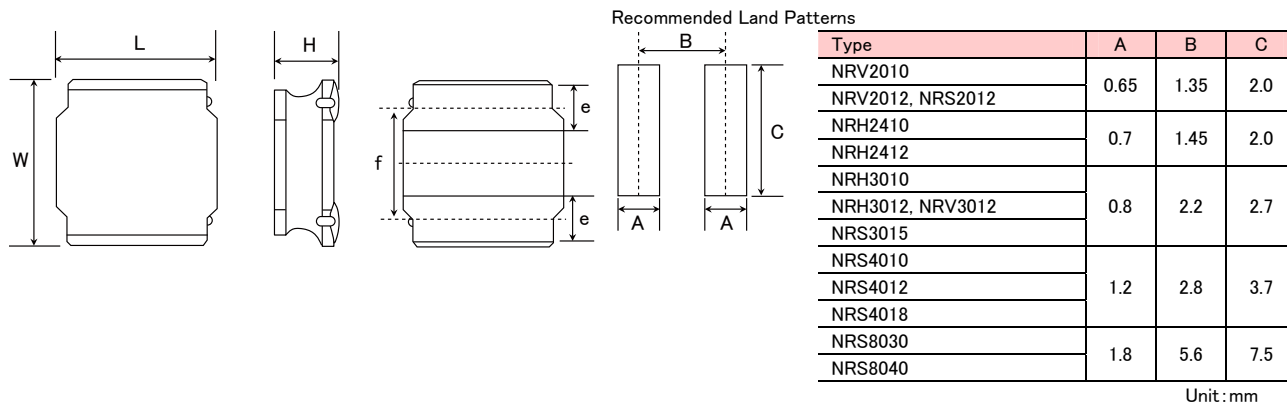

Type	L	W	H	e	f	Standard quantity [pcs] Taping
NRV2010	2.0±0.1 (0.079±0.004)	2.0±0.1 (0.079±0.004)	1.0 max (0.039 max)	0.5±0.2 (0.020±0.008)	1.25±0.2 (0.050±0.008)	2500
NRV2012 NRS2012	2.0±0.1 (0.079±0.004)	2.0±0.1 (0.079±0.004)	1.2 max (0.047 max)	0.5±0.2 (0.020±0.008)	1.25±0.2 (0.050±0.008)	2500
NRH2410	2.4±0.1 (0.095±0.00)	2.4±0.1 (0.095±0.004)	1.0 max (0.039 max)	0.6±0.2 (0.024±0.008)	1.45±0.2 (0.057±0.008)	2500
NRH2412	2.4±0.1 (0.095±0.004)	2.4±0.1 (0.095±0.004)	1.2 max (0.047 max)	0.6±0.2 (0.024±0.008)	1.45±0.2 (0.057±0.008)	2500
NRH3010	3.0±0.1 (0.118±0.004)	3.0±0.1 (0.118±0.004)	1.0 max (0.039 max)	0.9±0.2 (0.035±0.008)	1.9±0.2 (0.075±0.008)	2000
NRH3012 NRV3012	3.0±0.1 (0.118±0.004)	3.0±0.1 (0.118±0.004)	1.2 max (0.047 max)	0.9±0.2 (0.035±0.008)	1.9±0.2 (0.075±0.008)	2000
NRS3015	3.0±0.1 (0.118±0.004)	3.0±0.1 (0.118±0.004)	1.5 max (0.059 max)	0.9±0.2 (0.035±0.008)	1.9±0.2 (0.075±0.008)	2000
NRS4010	4.0±0.2 (0.158±0.008)	4.0±0.2 (0.158±0.008)	1.0 max (0.039 max)	1.1±0.2 (0.043±0.008)	2.5±0.2 (0.098±0.008)	5000
NRS4012	4.0±0.2 (0.158±0.008)	4.0±0.2 (0.158±0.008)	1.2 max (0.047 max)	1.1±0.2 (0.043±0.008)	2.5±0.2 (0.098±0.008)	4500
NRS4018	4.0±0.2 (0.158±0.008)	4.0±0.2 (0.158±0.008)	1.8 max (0.071 max)	1.1±0.2 (0.043±0.008)	2.5±0.2 (0.098±0.008)	3500
NRS8030	8.0±0.2 (0.315±0.008)	8.0±0.2 (0.315±0.008)	3.0 max (0.118 max)	1.60±0.3 (0.063±0.012)	5.6±0.3 (0.22±0.012)	1000
NRS8040	8.0±0.2 (0.315±0.008)	8.0±0.2 (0.315±0.008)	*1) 4.2 max (0.165 max) *2) 4.0 max (0.158 max)	1.60±0.3 (0.063±0.012)	5.6±0.3 (0.22±0.012)	1000

*1) 0R9~6R8 type, *2) 100~101type

Unit: mm (inch)

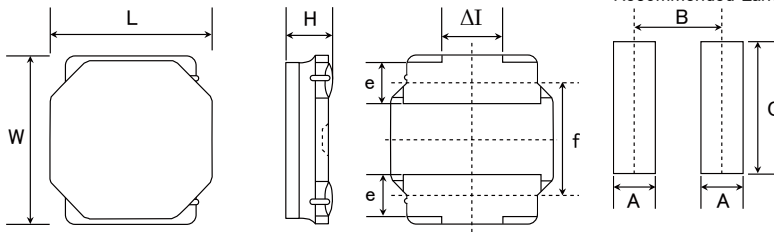

Type	A	B	C
NRS5010	1.5	3.6	4.0
NRS5012			
NRS5014			
NRS5020			
NRS5024			
NRS5030			
NRS5040	1.6	4.7	5.7
NRS6010			
NRS6012			
NRS6014			
NRS6020			
NRS6028			
NRS6045			

Unit: mm

Type	L	W	H	e	f	Δl	Standard quantity [pcs] Taping
NRS5010	4.9±0.2 (0.193±0.008)	4.9±0.2 (0.193±0.008)	1.0 max (0.039 max)	1.2±0.2 (0.047±0.008)	3.3±0.2 (0.130±0.008)	1.3typ (0.051typ)	1000
NRS5012	4.9±0.2 (0.193±0.008)	4.9±0.2 (0.193±0.008)	1.2 max (0.047 max)	1.2±0.2 (0.047±0.008)	3.3±0.2 (0.130±0.008)	1.3typ (0.051typ)	1000
NRS5014	4.9±0.2 (0.193±0.008)	4.9±0.2 (0.193±0.008)	1.4 max (0.055 max)	1.2±0.2 (0.047±0.008)	3.3±0.2 (0.130±0.008)	1.3typ (0.051typ)	1000
NRS5020	4.9±0.2 (0.193±0.008)	4.9±0.2 (0.193±0.008)	2.0 max (0.079 max)	1.2±0.2 (0.047±0.008)	3.3±0.2 (0.130±0.008)	1.3typ (0.051typ)	800
NRS5024	4.9±0.2 (0.193±0.008)	4.9±0.2 (0.193±0.008)	*3) 2.5 max (0.098 max) *4) 2.4 max (0.095 max)	1.2±0.2 (0.047±0.008)	3.3±0.2 (0.130±0.008)	1.3typ (0.051typ)	2500
NRS5030	4.9±0.2 (0.193±0.008)	4.9±0.2 (0.193±0.008)	*5) 3.1 max (0.122 max) *6) 3.0 max (0.118 max)	1.2±0.2 (0.047±0.008)	3.3±0.2 (0.130±0.008)	1.3typ (0.051typ)	500
NRS5040	4.9±0.2 (0.193±0.008)	4.9±0.2 (0.193±0.008)	*7) 4.1 max (0.161 max) *8) 4.0 max (0.158 max)	1.2±0.2 (0.047±0.008)	3.3±0.2 (0.130±0.008)	1.3typ (0.051typ)	1500
NRS6010	6.0±0.2 (0.236±0.008)	6.0±0.2 (0.236±0.008)	1.0 max (0.039 max)	1.35±0.2 (0.053±0.008)	4.0±0.2 (0.158±0.008)	2.3typ (0.091typ)	1000
NRS6012	6.0±0.2 (0.236±0.008)	6.0±0.2 (0.236±0.008)	1.2 max (0.047 max)	1.35±0.2 (0.053±0.008)	4.0±0.2 (0.158±0.008)	2.3typ (0.091typ)	1000
NRS6014	6.0±0.2 (0.236±0.008)	6.0±0.2 (0.236±0.008)	1.4 max (0.055 max)	1.35±0.2 (0.053±0.008)	4.0±0.2 (0.158±0.008)	2.3typ (0.091typ)	1000
NRS6020	6.0±0.2 (0.236±0.008)	6.0±0.2 (0.236±0.008)	2.0 max (0.079 max)	1.35±0.2 (0.053±0.008)	4.0±0.2 (0.158±0.008)	2.3typ (0.091typ)	2500
NRS6028	6.0±0.2 (0.236±0.008)	6.0±0.2 (0.236±0.008)	2.8 max (0.110 max)	1.35±0.2 (0.053±0.008)	4.0±0.2 (0.158±0.008)	2.3typ (0.091typ)	2000
NRS6045	6.0±0.2 (0.236±0.008)	6.0±0.2 (0.236±0.008)	4.5 max (0.177 max)	1.35±0.2 (0.053±0.008)	4.0±0.2 (0.158±0.008)	2.3typ (0.091typ)	1500

Unit: mm (inch)

- *3) 1R0~1R5 type, *4) 2R2~330 type
 *5) R47~100 type, *6) 150~470 type
 *7) 1R5~100 type, *8) 150~470 type

PART NUMBER

• All the SMD Power Inductors of the catalog lineup are RoHS compliant.

Note)

• The exchange of individual specifications is necessary depending on the application and circuit condition. Please contact Taiyo Yuden sales channels.

• *1: Automotive (AEC-Q200 Qualified) products for BODY & CHASSIS, and INFOTAINMENT. Please check "Automotive Application Guide" for further details before using the products.

< AEC-Q200 : AEC-Q200 qualified >

All the SMD Power Inductors of *1 marks are tested based on the test conditions and methods defined in AEC-Q200 by family item.

Please consult with TAIYO YUDEN's official sales channel for the details of the product specification and AEC-Q200 test results, etc.,

and please review and approve TAIYO YUDEN's product specification before ordering.

• *2: Industrial products and Medical products

● NRV2010 type

Part number	Nominal inductance [μ H]	Inductance tolerance	Self-resonant frequency [MHz] (min.)	DC Resistance [Ω] ($\pm 20\%$)	Rated current ※) [mA]		Measuring frequency [kHz]	Note
					Saturation current Idc1	Temperature rise current Idc2		
NRV2010T R47N GFV	0.47	$\pm 30\%$	-	0.052	2,100	2,000	100	*1, *2
NRV2010T R68N GFV	0.68	$\pm 30\%$	-	0.060	1,850	1,850	100	*1, *2
NRV2010T 1R0N GFV	1.0	$\pm 30\%$	-	0.080	1,550	1,600	100	*1, *2
NRV2010T 1R5M GFV	1.5	$\pm 20\%$	-	0.100	1,350	1,450	100	*1, *2
NRV2010T 2R2M GFV	2.2	$\pm 20\%$	-	0.175	1,100	1,100	100	*1, *2
NRV2010T 3R3M GFV	3.3	$\pm 20\%$	-	0.250	880	1,000	100	*1, *2
NRV2010T 4R7M GFV	4.7	$\pm 20\%$	-	0.320	760	820	100	*1, *2

● NRV2012 type

Part number	Nominal inductance [μ H]	Inductance tolerance	Self-resonant frequency [MHz] (min.)	DC Resistance [Ω] ($\pm 20\%$)	Rated current ※) [mA]		Measuring frequency [kHz]	Note
					Saturation current Idc1	Temperature rise current Idc2		
NRV2012T 1R0N GFV	1.0	$\pm 30\%$	-	0.073	2,200	1,650	100	*1, *2
NRV2012T 1R5N GFV	1.5	$\pm 30\%$	-	0.100	1,800	1,400	100	*1, *2
NRV2012T 2R2M GFV	2.2	$\pm 20\%$	-	0.129	1,600	1,200	100	*1, *2
NRV2012T 3R3M GFV	3.3	$\pm 20\%$	-	0.227	1,250	900	100	*1, *2
NRV2012T 4R7M GFV	4.7	$\pm 20\%$	-	0.325	1,100	750	100	*1, *2

● NRS2012 Shielded type

Part number	Nominal inductance [μ H]	Inductance tolerance	Self-resonant frequency [MHz] (min.)	DC Resistance [Ω] ($\pm 20\%$)	Rated current ※) [mA]		Measuring frequency [kHz]	Note
					Saturation current Idc1	Temperature rise current Idc2		
NRS2012T 1R0N GJV	1.0	$\pm 30\%$	-	0.070	1,900	1,700	100	*1, *2
NRS2012T 1R5N GJV	1.5	$\pm 30\%$	-	0.090	1,650	1,500	100	*1, *2
NRS2012T 2R2M GJV	2.2	$\pm 20\%$	-	0.107	1,350	1,370	100	*1, *2
NRS2012T 3R3M GJV	3.3	$\pm 20\%$	-	0.190	1,000	1,020	100	*1, *2
NRS2012T 4R7M GJV	4.7	$\pm 20\%$	-	0.241	900	910	100	*1, *2

● NRH2410 Shielded type

Part number	Nominal inductance [μ H]	Inductance tolerance	Self-resonant frequency [MHz] (min.)	DC Resistance [Ω] ($\pm 20\%$)	Rated current ※) [mA]		Measuring frequency [kHz]	Note
					Saturation current Idc1	Temperature rise current Idc2		
NRH2410T R68NN 4V	0.68	$\pm 30\%$	120	0.060	2,200	1,570	100	*1, *2
NRH2410T 1R0NN 4V	1.0	$\pm 30\%$	106	0.070	1,800	1,410	100	*1, *2
NRH2410T 1R5MN V	1.5	$\pm 20\%$	94	0.110	1,550	1,160	100	*1, *2
NRH2410T 2R2MN V	2.2	$\pm 20\%$	77	0.150	1,290	970	100	*1, *2
NRH2410T 3R3MN V	3.3	$\pm 20\%$	56	0.220	1,000	770	100	*1, *2
NRH2410T 4R7MN V	4.7	$\pm 20\%$	50	0.290	880	670	100	*1, *2
NRH2410T 6R8MN V	6.8	$\pm 20\%$	43	0.410	750	570	100	*1, *2
NRH2410T 100MN V	10	$\pm 20\%$	32	0.690	550	450	100	*1, *2
NRH2410T 150MN V	15	$\pm 20\%$	27	1.02	470	370	100	*1, *2
NRH2410T 220MN V	22	$\pm 20\%$	22	1.47	390	300	100	*1, *2

● NRH2412 Shielded type

Part number	Nominal inductance [μ H]	Inductance tolerance	Self-resonant frequency [MHz] (min.)	DC Resistance [Ω] ($\pm 20\%$)	Rated current ※) [mA]		Measuring frequency [kHz]	Note
					Saturation current Idc1	Temperature rise current Idc2		
NRH2412T R47NNGJV	0.47	$\pm 30\%$	180	0.050	2,900	2,100	100	*1, *2
NRH2412T 1R0NNGHV	1.0	$\pm 30\%$	101	0.077	2,350	1,300	100	*1, *2
NRH2412T 1R5NNGHV	1.5	$\pm 30\%$	89	0.100	2,100	1,150	100	*1, *2
NRH2412T 2R2MNGHV	2.2	$\pm 20\%$	72	0.140	1,700	1,000	100	*1, *2
NRH2412T 3R3MNGHV	3.3	$\pm 20\%$	56	0.225	1,400	750	100	*1, *2
NRH2412T 4R7MNGHV	4.7	$\pm 20\%$	45	0.300	1,150	650	100	*1, *2
NRH2412T 6R8MNGHV	6.8	$\pm 20\%$	34	0.420	950	550	100	*1, *2
NRH2412T 100MNGHV	10	$\pm 20\%$	29	0.600	810	450	100	*1, *2

※) The saturation current value (Idc1) is the DC current value having inductance decrease down to 30%. (at 20°C)

※) The temperature rise current value (Idc2) is the DC current value having temperature increase up to 40°C. (at 20°C)

※) The rated current is the DC current value that satisfies both of current value saturation current value and temperature rise current value.

■ PART NUMBER

● NRH3010 Shielded type

Part number	Nominal inductance [μH]	Inductance tolerance	Self-resonant frequency [MHz] (min.)	DC Resistance [Ω] (±20%)	Rated current ※) [mA]		Measuring frequency[kHz]	Note
					Saturation current I _{dc1}	Temperature rise current I _{dc2}		
NRH3010T 1R2NN V	1.2	±30%	120	0.065	1,700	1,480	100	*1, *2
NRH3010T 1R5NN V	1.5	±30%	99	0.075	1,440	1,370	100	*1, *2
NRH3010T 2R2MN V	2.2	±20%	86	0.083	1,300	1,300	100	*1, *2
NRH3010T 3R3MN V	3.3	±20%	64	0.130	1,000	1,030	100	*1, *2
NRH3010T 4R7MN V	4.7	±20%	50	0.170	850	900	100	*1, *2
NRH3010T 6R8MN V	6.8	±20%	44	0.250	700	745	100	*1, *2
NRH3010T 100MN V	10	±20%	34	0.350	600	620	100	*1, *2
NRH3010T 150MN V	15	±20%	25	0.550	450	480	100	*1, *2
NRH3010T 220MN V	22	±20%	22	0.770	380	410	100	*1, *2
NRH3010T 470MN V	47	±20%	17	2.05	250	285	100	*1, *2

● NRH3012 Shielded type

Part number	Nominal inductance [μH]	Inductance tolerance	Self-resonant frequency [MHz] (min.)	DC Resistance [Ω] (±20%)	Rated current ※) [mA]		Measuring frequency[kHz]	Note
					Saturation current I _{dc1}	Temperature rise current I _{dc2}		
NRH3012T R47NN V	0.47	±30%	160	0.033	2,600	1,900	100	*1, *2
NRH3012T 1R0NN V	1.0	±30%	111	0.048	2,200	1,710	100	*1, *2
NRH3012T 1R5NN V	1.5	±30%	95	0.055	1,700	1,600	100	*1, *2
NRH3012T 2R2MN V	2.2	±20%	78	0.075	1,500	1,370	100	*1, *2
NRH3012T 3R3MN V	3.3	±20%	61	0.100	1,200	1,210	100	*1, *2
NRH3012T 4R7MN V	4.7	±20%	50	0.130	1,000	1,060	100	*1, *2
NRH3012T 6R8MN V	6.8	±20%	43	0.190	850	890	100	*1, *2
NRH3012T 100MN V	10	±20%	32	0.270	730	720	100	*1, *2
NRH3012T 150MN V	15	±20%	26	0.450	530	570	100	*1, *2
NRH3012T 220MN V	22	±20%	22	0.630	500	500	100	*1, *2

● NRV3012 Shielded type

Part number	Nominal inductance [μH]	Inductance tolerance	Self-resonant frequency [MHz] (min.)	DC Resistance [Ω] (±20%)	Rated current ※) [mA]		Measuring frequency[kHz]	Note
					Saturation current I _{dc1}	Temperature rise current I _{dc2}		
NRV3012T 1R0N V	1.0	±30%	110	0.065	2,500	1,600	100	*1, *2
NRV3012T 1R5N V	1.5	±30%	92	0.075	2,100	1,400	100	*1, *2
NRV3012T 2R2M V	2.2	±20%	70	0.120	1,800	1,100	100	*1, *2
NRV3012T 3R3M V	3.3	±20%	55	0.150	1,600	1,000	100	*1, *2
NRV3012T 4R7M V	4.7	±20%	48	0.190	1,250	850	100	*1, *2
NRV3012T 6R8M V	6.8	±20%	40	0.300	950	650	100	*1, *2
NRV3012T 100M V	10	±20%	32	0.470	800	550	100	*1, *2

● NRS3015 Shielded type

Part number	Nominal inductance [μH]	Inductance tolerance	Self-resonant frequency [MHz] (min.)	DC Resistance [Ω] (±20%)	Rated current ※) [mA]		Measuring frequency[kHz]	Note
					Saturation current I _{dc1}	Temperature rise current I _{dc2}		
NRS3015T 1R0NNGHV	1.0	±30%	100	0.030	2,100	2,100	100	*1, *2
NRS3015T 1R5NNGHV	1.5	±30%	87	0.038	1,800	1,820	100	*1, *2
NRS3015T 2R2MNGHV	2.2	±20%	64	0.058	1,480	1,500	100	*1, *2
NRS3015T 3R3MNGHV	3.3	±20%	49	0.078	1,210	1,230	100	*1, *2
NRS3015T 4R7MNGHV	4.7	±20%	40	0.120	1,020	1,040	100	*1, *2
NRS3015T 6R8MNGHV	6.8	±20%	36	0.160	870	880	100	*1, *2
NRS3015T 100MNGHV	10	±20%	28	0.220	700	710	100	*1, *2
NRS3015T 220MNGHV	22	±20%	20	0.520	470	470	100	*1, *2

● NRS4010 Shielded type

Part number	Nominal inductance [μH]	Inductance tolerance	Self-resonant frequency [MHz] (min.)	DC Resistance [Ω] (±20%)	Rated current ※) [mA]		Measuring frequency[kHz]	Note
					Saturation current I _{dc1}	Temperature rise current I _{dc2}		
NRS4010T 1R0NDGGV	1.0	±30%	116	0.056	2,000	1,900	100	*1, *2
NRS4010T 2R2MDGGV	2.2	±20%	73	0.085	1,200	1,500	100	*1, *2
NRS4010T 3R3MDGGV	3.3	±20%	58	0.100	1,100	1,400	100	*1, *2
NRS4010T 4R7MDGGV	4.7	±20%	47	0.140	950	1,200	100	*1, *2
NRS4010T 6R8MDGGV	6.8	±20%	38	0.200	800	1,000	100	*1, *2
NRS4010T 100MDGGV	10	±20%	31	0.300	620	750	100	*1, *2
NRS4010T 150MDGGV	15	±20%	24	0.430	540	600	100	*1, *2
NRS4010T 220MDGGV	22	±20%	19	0.570	450	500	100	*1, *2

● NRS4012 Shielded type

Part number	Nominal inductance [μH]	Inductance tolerance	Self-resonant frequency [MHz] (min.)	DC Resistance [Ω] (±20%)	Rated current ※) [mA]		Measuring frequency[kHz]	Note
					Saturation current I _{dc1}	Temperature rise current I _{dc2}		
NRS4012T 1R0NDGGV	1.0	±30%	100	0.042	2,800	2,200	100	*1, *2
NRS4012T 2R2MDGJV	2.2	±20%	70	0.060	1,650	1,900	100	*1, *2
NRS4012T 3R3MDGJV	3.3	±20%	60	0.070	1,400	1,700	100	*1, *2
NRS4012T 4R7MDGJV	4.7	±20%	45	0.095	1,200	1,500	100	*1, *2
NRS4012T 6R8MDGJV	6.8	±20%	35	0.125	900	1,300	100	*1, *2
NRS4012T 100MDGJV	10	±20%	30	0.170	800	1,100	100	*1, *2
NRS4012T 150MDGJV	15	±20%	24	0.260	650	750	100	*1, *2
NRS4012T 220MDGJV	22	±20%	18	0.400	500	620	100	*1, *2

※) The saturation current value (I_{dc1}) is the DC current value having inductance decrease down to 30%. (at 20°C)

※) The temperature rise current value (I_{dc2}) is the DC current value having temperature increase up to 40°C. (at 20°C)

※) The rated current is the DC current value that satisfies both of current value saturation current value and temperature rise current value.

▶ This catalog contains the typical specification only due to the limitation of space. When you consider the purchase of our products, please check our product specification sheets. For details of each product (characteristics graph, reliability information, precautions for use, and so on), see our website (<http://www.ty-top.com/>).

PART NUMBER

● NRS4018 Shielded type

Part number	Nominal inductance [μ H]	Inductance tolerance	Self-resonant frequency [MHz] (min.)	DC Resistance [Ω] ($\pm 20\%$)	Rated current ※) [mA]		Measuring frequency [kHz]	Note
					Saturation current Idc1	Temperature rise current Idc2		
NRS4018T 1R0NDGJV	1.0	$\pm 30\%$	90	0.027	4,000	3,200	100	*1, *2
NRS4018T 1R5NDGJV	1.5	$\pm 30\%$	75	0.037	3,300	2,400	100	*1, *2
NRS4018T 2R2MDGJV	2.2	$\pm 20\%$	60	0.042	3,000	2,200	100	*1, *2
NRS4018T 3R3MDGJV	3.3	$\pm 20\%$	45	0.055	2,300	2,000	100	*1, *2
NRS4018T 4R7MDGJV	4.7	$\pm 20\%$	35	0.070	2,000	1,700	100	*1, *2
NRS4018T 6R8MDGJV	6.8	$\pm 20\%$	30	0.098	1,600	1,450	100	*1, *2
NRS4018T 100MDGJV	10	$\pm 20\%$	25	0.150	1,300	1,200	100	*1, *2
NRS4018T 150MDGJV	15	$\pm 20\%$	18	0.210	1,100	850	100	*1, *2
NRS4018T 220MDGJV	22	$\pm 20\%$	15	0.290	900	720	100	*1, *2
NRS4018T 330MDGJV	33	$\pm 20\%$	12	0.460	700	550	100	*1, *2
NRS4018T 470MDGJV	47	$\pm 20\%$	10	0.650	600	440	100	*1, *2
NRS4018T 680MDGJV	68	$\pm 20\%$	8.3	1.00	520	320	100	*1, *2
NRS4018T 101MDGJV	100	$\pm 20\%$	6.5	1.45	420	280	100	*1, *2
NRS4018T 151MDGJV	150	$\pm 20\%$	5.5	2.30	340	220	100	*1, *2
NRS4018T 221MDGJV	220	$\pm 20\%$	4.0	3.80	275	170	100	*1, *2

● NRS5010 type

Part number	Nominal inductance [μ H]	Inductance tolerance	Self-resonant frequency [MHz] (min.)	DC Resistance [Ω] ($\pm 20\%$)	Rated current ※) [mA]		Measuring frequency [kHz]	Note
					Saturation current Idc1	Temperature rise current Idc2		
NRS5010T 1R0NMGFV	1.0	$\pm 30\%$	95	0.070	2,350	1,750	100	*1, *2
NRS5010T 2R2NMGFV	2.2	$\pm 30\%$	65	0.105	1,500	1,400	100	*1, *2
NRS5010T 3R3MMGFV	3.3	$\pm 20\%$	42	0.125	1,400	1,250	100	*1, *2
NRS5010T 4R7MMGFV	4.7	$\pm 20\%$	37	0.145	1,200	1,150	100	*1, *2
NRS5010T 6R8MMGFV	6.8	$\pm 20\%$	33	0.185	1,000	1,000	100	*1, *2
NRS5010T 100MMGFV	10	$\pm 20\%$	23	0.250	850	900	100	*1, *2
NRS5010T 150MMGFV	15	$\pm 20\%$	19	0.400	680	650	100	*1, *2
NRS5010T 220MMGFV	22	$\pm 20\%$	15	0.600	550	450	100	*1, *2

● NRS5012 type

Part number	Nominal inductance [μ H]	Inductance tolerance	Self-resonant frequency [MHz] (min.)	DC Resistance [Ω] ($\pm 20\%$)	Rated current ※) [mA]		Measuring frequency [kHz]	Note
					Saturation current Idc1	Temperature rise current Idc2		
NRS5012T 1R0NMGFV	1.0	$\pm 30\%$	100	0.053	4,500	2,300	100	*1, *2
NRS5012T 1R5NMGFV	1.5	$\pm 30\%$	86	0.070	3,800	2,200	100	*1, *2
NRS5012T 2R2MMGFV	2.2	$\pm 20\%$	70	0.085	3,100	2,000	100	*1, *2
NRS5012T 3R3MMGFV	3.3	$\pm 20\%$	48	0.160	2,400	1,450	100	*1, *2
NRS5012T 4R7MMGFV	4.7	$\pm 20\%$	40	0.180	2,200	1,400	100	*1, *2
NRS5012T 6R8MMGFV	6.8	$\pm 20\%$	36	0.260	1,700	1,100	100	*1, *2
NRS5012T 100MMGFV	10	$\pm 20\%$	26	0.420	1,400	850	100	*1, *2
NRS5012T 150MMGFV	15	$\pm 20\%$	22	0.670	1,200	640	100	*1, *2

● NRS5014 Shielded type

Part number	Nominal inductance [μ H]	Inductance tolerance	Self-resonant frequency [MHz] (min.)	DC Resistance [Ω] ($\pm 20\%$)	Rated current ※) [mA]		Measuring frequency [kHz]	Note
					Saturation current Idc1	Temperature rise current Idc2		
NRS5014T R47NMGV	0.47	$\pm 30\%$	185	0.025	5,800	3,300	100	*1, *2
NRS5014T 1R2NMGV	1.2	$\pm 30\%$	86	0.045	3,800	2,400	100	*1, *2
NRS5014T 2R2NMGV	2.2	$\pm 30\%$	56	0.065	2,800	2,000	100	*1, *2
NRS5014T 3R3NMGV	3.3	$\pm 30\%$	48	0.080	2,350	1,700	100	*1, *2
NRS5014T 4R7NMGV	4.7	$\pm 30\%$	41	0.100	2,050	1,400	100	*1, *2
NRS5014T 6R8NMGV	6.8	$\pm 20\%$	33	0.150	1,600	1,200	100	*1, *2
NRS5014T 100MMGV	10	$\pm 20\%$	27	0.200	1,400	1,050	100	*1, *2
NRS5014T 150MMGV	15	$\pm 20\%$	20	0.320	1,100	650	100	*1, *2
NRS5014T 220MMGV	22	$\pm 20\%$	16	0.450	900	550	100	*1, *2

● NRS5020 Shielded type

Part number	Nominal inductance [μ H]	Inductance tolerance	Self-resonant frequency [MHz] (min.)	DC Resistance [Ω] ($\pm 20\%$)	Rated current ※) [mA]		Measuring frequency [kHz]	Note
					Saturation current Idc1	Temperature rise current Idc2		
NRS5020T R47NMGJV	0.47	$\pm 30\%$	230	0.012	6,100	5,000	100	*1, *2
NRS5020T 1R0NMGJV	1.0	$\pm 30\%$	81	0.021	4,000	3,600	100	*1, *2
NRS5020T 1R5NMGJV	1.5	$\pm 30\%$	68	0.026	3,350	3,200	100	*1, *2
NRS5020T 2R2NMGJV	2.2	$\pm 30\%$	57	0.035	2,900	2,900	100	*1, *2
NRS5020T 3R3NMGJV	3.3	$\pm 30\%$	46	0.048	2,400	2,400	100	*1, *2
NRS5020T 4R7MMGV	4.7	$\pm 20\%$	37	0.060	2,000	2,000	100	*1, *2
NRS5020T 6R8MMGV	6.8	$\pm 20\%$	30	0.090	1,600	1,650	100	*1, *2
NRS5020T 100MMGV	10	$\pm 20\%$	24	0.120	1,300	1,450	100	*1, *2
NRS5020T 150MMGV	15	$\pm 20\%$	20	0.165	1,100	1,200	100	*1, *2
NRS5020T 220MMGV	22	$\pm 20\%$	17	0.260	900	1,000	100	*1, *2
NRS5020T 470MMGV	47	$\pm 20\%$	12	0.435	630	560	100	*1, *2
NRS5020T 101MMGV	100	$\pm 20\%$	7	0.850	420	400	100	*1, *2

※) The saturation current value (Idc1) is the DC current value having inductance decrease down to 30%. (at 20°C)

※) The temperature rise current value (Idc2) is the DC current value having temperature increase up to 40°C. (at 20°C)

※) The rated current is the DC current value that satisfies both of current value saturation current value and temperature rise current value.

PART NUMBER

● NRS5024 Shielded type

Part number	Nominal inductance [μ H]	Inductance tolerance	Self-resonant frequency [MHz] (min.)	DC Resistance [Ω] ($\pm 20\%$)	Rated current ※) [mA]		Measuring frequency [kHz]	Note
					Saturation current Idc1	Temperature rise current Idc2		
NRS5024T 1R0NMGJV	1.0	$\pm 30\%$	85	0.016	5,800	4,400	100	*1, *2
NRS5024T 1R5NMGJV	1.5	$\pm 30\%$	67	0.022	5,200	3,600	100	*1, *2
NRS5024T 2R2NMGJV	2.2	$\pm 30\%$	51	0.029	4,100	3,100	100	*1, *2
NRS5024T 3R3NMGJV	3.3	$\pm 30\%$	41	0.043	3,100	2,400	100	*1, *2
NRS5024T 4R7MMGJV	4.7	$\pm 20\%$	37	0.055	2,700	2,000	100	*1, *2
NRS5024T 6R8MMGJV	6.8	$\pm 20\%$	28	0.080	2,200	1,600	100	*1, *2
NRS5024T 100MMGJV	10	$\pm 20\%$	21	0.125	1,700	1,200	100	*1, *2
NRS5024T 150MMGJV	15	$\pm 20\%$	18	0.170	1,400	1,000	100	*1, *2
NRS5024T 220MMGJV	22	$\pm 20\%$	15	0.230	1,200	820	100	*1, *2
NRS5024T 330MMGJV	33	$\pm 20\%$	11	0.370	1,000	630	100	*1, *2

● NRS5030 Shielded type

Part number	Nominal inductance [μ H]	Inductance tolerance	Self-resonant frequency [MHz] (min.)	DC Resistance [Ω] ($\pm 30\%$)	Rated current ※) [mA]		Measuring frequency [kHz]	Note
					Saturation current Idc1	Temperature rise current Idc2		
NRS5030T R47NMGJV	0.47	$\pm 30\%$	185	0.010	9,000	5,000	100	*1, *2
NRS5030T 1R0NMGJV	1.0	$\pm 30\%$	110	0.015	6,600	4,000	100	*1, *2
NRS5030T 2R2NMGJV	2.2	$\pm 30\%$	46	0.023	4,200	3,500	100	*1, *2
NRS5030T 3R3MMGJV	3.3	$\pm 20\%$	36	0.030	3,600	3,000	100	*1, *2
NRS5030T 4R7MMGJV	4.7	$\pm 20\%$	31	0.035	3,100	2,600	100	*1, *2
NRS5030T 6R8MMGJV	6.8	$\pm 20\%$	22	0.052	2,500	2,300	100	*1, *2
NRS5030T 100MMGJV	10	$\pm 20\%$	20	0.070	2,100	1,700	100	*1, *2
NRS5030T 150MMGJV	15	$\pm 20\%$	14	0.125	1,600	1,400	100	*1, *2
NRS5030T 220MMGJV	22	$\pm 20\%$	13	0.180	1,400	1,050	100	*1, *2
NRS5030T 330MMGJV	33	$\pm 20\%$	10	0.225	1,150	800	100	*1, *2
NRS5030T 470MMGJV	47	$\pm 20\%$	9	0.325	950	700	100	*1, *2

● NRS5040 Shielded type

Part number	Nominal inductance [μ H]	Inductance tolerance	Self-resonant frequency [MHz] (min.)	DC Resistance [Ω] ($\pm 30\%$)	Rated current ※) [mA]		Measuring frequency [kHz]	Note
					Saturation current Idc1	Temperature rise current Idc2		
NRS5040T 1R5NMGJV	1.5	$\pm 30\%$	60	0.017	6,400	4,500	100	*1, *2
NRS5040T 2R2NMGJV	2.2	$\pm 30\%$	42	0.022	5,000	3,700	100	*1, *2
NRS5040T 3R3NMGJV	3.3	$\pm 30\%$	32	0.027	4,000	3,300	100	*1, *2
NRS5040T 4R7NMGJV	4.7	$\pm 30\%$	28	0.029	3,300	3,100	100	*1, *2
NRS5040T 6R8MMGJV	6.8	$\pm 20\%$	21	0.049	2,800	2,400	100	*1, *2
NRS5040T 100MMGJV	10	$\pm 20\%$	18	0.056	2,300	2,100	100	*1, *2
NRS5040T 150MMGJV	15	$\pm 20\%$	13	0.080	2,000	1,800	100	*1, *2
NRS5040T 220MMGJV	22	$\pm 20\%$	9	0.126	1,500	1,400	100	*1, *2
NRS5040T 330MMGJV	33	$\pm 20\%$	7	0.180	1,300	1,200	100	*1, *2
NRS5040T 470MMGJV	47	$\pm 20\%$	6	0.310	1,100	900	100	*1, *2

● NRS6010 type

Part number	Nominal inductance [μ H]	Inductance tolerance	Self-resonant frequency [MHz] (min.)	DC Resistance [Ω] ($\pm 20\%$)	Rated current ※) [mA]		Measuring frequency [kHz]	Note
					Saturation current Idc1	Temperature rise current Idc2		
NRS6010T 1R5MMGFV	1.5	$\pm 20\%$	77	0.090	2,400	1,900	100	*1, *2
NRS6010T 2R2MMGFV	2.2	$\pm 20\%$	56	0.110	1,900	1,700	100	*1, *2
NRS6010T 3R3MMGFV	3.3	$\pm 20\%$	42	0.135	1,600	1,500	100	*1, *2
NRS6010T 4R7MMGFV	4.7	$\pm 20\%$	36	0.165	1,300	1,400	100	*1, *2
NRS6010T 6R8MMGFV	6.8	$\pm 20\%$	30	0.220	1,200	1,200	100	*1, *2
NRS6010T 100MMGFV	10	$\pm 20\%$	25	0.270	1,000	1,100	100	*1, *2
NRS6010T 220MMGFV	22	$\pm 20\%$	12	0.580	650	700	100	*1, *2

● NRS6012 Shielded type

Part number	Nominal inductance [μ H]	Inductance tolerance	Self-resonant frequency [MHz] (min.)	DC Resistance [Ω] ($\pm 20\%$)	Rated current ※) [mA]		Measuring frequency [kHz]	Note
					Saturation current Idc1	Temperature rise current Idc2		
NRS6012T 1R0NMGJV	1.0	$\pm 30\%$	95	0.050	3,000	2,400	100	*1, *2
NRS6012T 1R5NMGJV	1.5	$\pm 30\%$	69	0.067	2,600	2,100	100	*1, *2
NRS6012T 2R5NMGJV	2.5	$\pm 30\%$	45	0.090	2,100	1,800	100	*1, *2
NRS6012T 3R3NMGJV	3.3	$\pm 30\%$	42	0.105	1,800	1,700	100	*1, *2
NRS6012T 4R7MMGJV	4.7	$\pm 20\%$	36	0.125	1,600	1,550	100	*1, *2
NRS6012T 5R3MMGJV	5.3	$\pm 20\%$	34	0.125	1,500	1,550	100	*1, *2
NRS6012T 6R8MMGJV	6.8	$\pm 20\%$	30	0.165	1,300	1,350	100	*1, *2
NRS6012T 100MMGJV	10	$\pm 20\%$	22	0.200	1,000	1,200	100	*1, *2
NRS6012T 150MMGJV	15	$\pm 20\%$	18	0.295	800	800	100	*1, *2
NRS6012T 220MMGJV	22	$\pm 20\%$	12	0.465	760	650	100	*1, *2
NRS6012T 330MMGJV	33	$\pm 20\%$	8	0.580	590	550	100	*1, *2
NRS6012T 470MMGJV	47	$\pm 20\%$	6	0.965	520	460	100	*1, *2
NRS6012T 680MMGJV	68	$\pm 20\%$	3	1.16	440	410	100	*1, *2
NRS6012T 101MMGJV	100	$\pm 20\%$	1	1.67	350	320	100	*1, *2

※) The saturation current value (Idc1) is the DC current value having inductance decrease down to 30%. (at 20°C)

※) The temperature rise current value (Idc2) is the DC current value having temperature increase up to 40°C. (at 20°C)

※) The rated current is the DC current value that satisfies both of current value saturation current value and temperature rise current value.

▶ This catalog contains the typical specification only due to the limitation of space. When you consider the purchase of our products, please check our product specification sheets. For details of each product (characteristics graph, reliability information, precautions for use, and so on), see our website (<http://www.ty-top.com/>).

PART NUMBER

● NRS6014 Shielded type

Part number	Nominal inductance [μ H]	Inductance tolerance	Self-resonant frequency [MHz] (min.)	DC Resistance [Ω] ($\pm 20\%$)	Rated current ※) [mA]		Measuring frequency [kHz]	Note
					Saturation current Idc1	Temperature rise current Idc2		
NRS6014T 1R2NMGV	1.2	$\pm 30\%$	77	0.042	4,000	2,750	100	*1, *2
NRS6014T 2R2NMGV	2.2	$\pm 30\%$	61	0.055	3,000	2,300	100	*1, *2
NRS6014T 3R3NMGV	3.3	$\pm 30\%$	41	0.075	2,500	2,000	100	*1, *2
NRS6014T 4R7MMGV	4.7	$\pm 20\%$	36	0.090	2,000	1,900	100	*1, *2
NRS6014T 6R8MMGV	6.8	$\pm 20\%$	30	0.115	1,700	1,650	100	*1, *2
NRS6014T 100MMGV	10	$\pm 20\%$	24	0.140	1,400	1,400	100	*1, *2
NRS6014T 150MMGV	15	$\pm 20\%$	20	0.210	1,150	1,200	100	*1, *2
NRS6014T 220MMGV	22	$\pm 20\%$	16	0.300	950	1,000	100	*1, *2

● NRS6020 Shielded type

Part number	Nominal inductance [μ H]	Inductance tolerance	Self-resonant frequency [MHz] (min.)	DC Resistance [Ω] ($\pm 20\%$)	Rated current ※) [mA]		Measuring frequency [kHz]	Note
					Saturation current Idc1	Temperature rise current Idc2		
NRS6020T 0R8NMGV	0.8	$\pm 30\%$	110	0.020	6,400	4,100	100	*1, *2
NRS6020T 1R5NMGV	1.5	$\pm 30\%$	93	0.026	4,300	3,600	100	*1, *2
NRS6020T 2R2NMGV	2.2	$\pm 30\%$	73	0.034	3,200	2,900	100	*1, *2
NRS6020T 3R3NMGV	3.3	$\pm 30\%$	55	0.040	2,800	2,750	100	*1, *2
NRS6020T 4R7NMGV	4.7	$\pm 30\%$	43	0.058	2,400	2,150	100	*1, *2
NRS6020T 6R8NMGV	6.8	$\pm 30\%$	30	0.085	2,000	1,800	100	*1, *2
NRS6020T 100MMGV	10	$\pm 20\%$	18	0.125	1,900	1,500	100	*1, *2
NRS6020T 220MMGV	22	$\pm 20\%$	11	0.290	1,250	950	100	*1, *2

● NRS6028 Shielded type

Part number	Nominal inductance [μ H]	Inductance tolerance	Self-resonant frequency [MHz] (min.)	DC Resistance [Ω] ($\pm 30\%$)	Rated current ※) [mA]		Measuring frequency [kHz]	Note
					Saturation current Idc1	Temperature rise current Idc2		
NRS6028T 0R9NMGV	0.9	$\pm 30\%$	90	0.013	6,700	4,600	100	*1, *2
NRS6028T 1R5NMGV	1.5	$\pm 30\%$	78	0.016	5,100	4,200	100	*1, *2
NRS6028T 2R2NMGV	2.2	$\pm 30\%$	68	0.020	4,200	3,700	100	*1, *2
NRS6028T 3R0NMGV	3.0	$\pm 30\%$	55	0.023	3,600	3,400	100	*1, *2
NRS6028T 4R7MMGV	4.7	$\pm 20\%$	39	0.031	2,700	3,000	100	*1, *2
NRS6028T 6R8MMGV	6.8	$\pm 20\%$	25	0.043	2,600	2,500	100	*1, *2
NRS6028T 100MMGV	10	$\pm 20\%$	20	0.065	1,900	1,900	100	*1, *2
NRS6028T 150MMGV	15	$\pm 20\%$	17	0.095	1,600	1,800	100	*1, *2
NRS6028T 220MMGV	22	$\pm 20\%$	12	0.135	1,300	1,400	100	*1, *2
NRS6028T 330MMGV	33	$\pm 20\%$	10	0.220	1,100	1,100	100	*1, *2
NRS6028T 470MMGV	47	$\pm 20\%$	8	0.300	1,000	920	100	*1, *2
NRS6028T 680MMGV	68	$\pm 20\%$	5	0.420	800	770	100	*1, *2
NRS6028T 101MMGV	100	$\pm 20\%$	3	0.600	650	660	100	*1, *2

● NRS6045 Shielded type

Part number	Nominal inductance [μ H]	Inductance tolerance	Self-resonant frequency [MHz] (min.)	DC Resistance [Ω] ($\pm 30\%$)	Rated current ※) [mA]		Measuring frequency [kHz]	Note
					Saturation current Idc1	Temperature rise current Idc2		
NRS6045T 1R0NMGV	1.0	$\pm 30\%$	110	0.014	9,800	4,500	100	*1, *2
NRS6045T 1R3NMGV	1.3	$\pm 30\%$	95	0.016	8,200	4,200	100	*1, *2
NRS6045T 1R8NMGV	1.8	$\pm 30\%$	80	0.019	7,200	3,900	100	*1, *2
NRS6045T 2R3NMGV	2.3	$\pm 30\%$	60	0.022	6,400	3,600	100	*1, *2
NRS6045T 3R0NMGV	3.0	$\pm 30\%$	45	0.024	5,600	3,300	100	*1, *2
NRS6045T 4R5MMGV	4.5	$\pm 20\%$	25	0.030	4,400	3,100	100	*1, *2
NRS6045T 6R3MMGV	6.3	$\pm 20\%$	15	0.036	3,600	3,000	100	*1, *2
NRS6045T 100MMGV	10	$\pm 20\%$	12	0.046	3,100	2,400	100	*1, *2
NRS6045T 150MMGV	15	$\pm 20\%$	10	0.070	2,500	1,900	100	*1, *2
NRS6045T 220MMGV	22	$\pm 20\%$	7	0.107	2,000	1,600	100	*1, *2
NRS6045T 330MMGV	33	$\pm 20\%$	6	0.141	1,650	1,400	100	*1, *2
NRS6045T 470MMGV	47	$\pm 20\%$	5	0.211	1,400	1,150	100	*1, *2
NRS6045T 680MMGV	68	$\pm 20\%$	4	0.304	1,100	950	100	*1, *2
NRS6045T 101MMGV	100	$\pm 20\%$	3	0.466	900	750	100	*1, *2

● NRS8030 Shielded type

Part number	Nominal inductance [μ H]	Inductance tolerance	Self-resonant frequency [MHz] (min.)	DC Resistance [Ω] ($\pm 30\%$)	Rated current ※) [mA]		Measuring frequency [kHz]	Note
					Saturation current Idc1	Temperature rise current Idc2		
NRS8030T 1R0NJGV	1.0	$\pm 30\%$	120	0.009	7,800	6,200	100	*1, *2
NRS8030T 1R5NJGV	1.5	$\pm 30\%$	80	0.012	6,200	5,300	100	*1, *2
NRS8030T 2R2NJGV	2.2	$\pm 30\%$	60	0.015	4,900	4,800	100	*1, *2
NRS8030T 3R3MJGV	3.3	$\pm 20\%$	50	0.019	4,200	4,300	100	*1, *2
NRS8030T 4R7MJGV	4.7	$\pm 20\%$	40	0.022	3,600	4,000	100	*1, *2
NRS8030T 6R8MJGV	6.8	$\pm 20\%$	32	0.029	3,000	3,400	100	*1, *2
NRS8030T 100MJGV	10	$\pm 20\%$	27	0.033	2,400	3,000	100	*1, *2
NRS8030T 150MJGV	15	$\pm 20\%$	20	0.060	2,000	2,200	100	*1, *2
NRS8030T 220MJGV	22	$\pm 20\%$	16	0.070	1,750	1,900	100	*1, *2
NRS8030T 330MJGV	33	$\pm 20\%$	13	0.120	1,300	1,500	100	*1, *2
NRS8030T 470MJGV	47	$\pm 20\%$	11	0.170	1,100	1,300	100	*1, *2

※) The saturation current value (Idc1) is the DC current value having inductance decrease down to 30%. (at 20°C)

※) The temperature rise current value (Idc2) is the DC current value having temperature increase up to 40°C. (at 20°C)

※) The rated current is the DC current value that satisfies both of current value saturation current value and temperature rise current value.

► This catalog contains the typical specification only due to the limitation of space. When you consider the purchase of our products, please check our product specification sheets. For details of each product (characteristics graph, reliability information, precautions for use, and so on), see our website (<http://www.ty-top.com/>).

PART NUMBER

● NRS8040 Shielded type

Part number	Nominal inductance [μ H]	Inductance tolerance	Self-resonant frequency [MHz] (min.)	DC Resistance [Ω] ($\pm 30\%$)	Rated current ※) [mA]		Measuring frequency[kHz]	Note
					Saturation current Idc1	Temperature rise current Idc2		
NRS8040T 0R9NJGJV	0.9	$\pm 30\%$	85	0.006	13,000	7,800	100	*1, *2
NRS8040T 1R4NJGJV	1.4	$\pm 30\%$	63	0.007	10,000	7,000	100	*1, *2
NRS8040T 2R0NJGJV	2.0	$\pm 30\%$	50	0.009	8,100	6,300	100	*1, *2
NRS8040T 3R6NJGJV	3.6	$\pm 30\%$	34	0.015	6,400	4,900	100	*1, *2
NRS8040T 4R7NJGJV	4.7	$\pm 30\%$	30	0.018	5,400	4,100	100	*1, *2
NRS8040T 6R8NJGJV	6.8	$\pm 30\%$	24	0.025	4,400	3,700	100	*1, *2
NRS8040T 100MJGJV	10	$\pm 20\%$	22	0.034	3,800	3,100	100	*1, *2
NRS8040T 150MJGJV	15	$\pm 20\%$	16	0.050	2,900	2,400	100	*1, *2
NRS8040T 220MJGJV	22	$\pm 20\%$	13	0.066	2,400	2,200	100	*1, *2
NRS8040T 330MJGKV	33	$\pm 20\%$	12	0.100	2,000	1,700	100	*1, *2
NRS8040T 470MJGKV	47	$\pm 20\%$	8	0.140	1,500	1,500	100	*1, *2
NRS8040T 101MJGKV	100	$\pm 20\%$	6	0.280	1,100	1,000	100	*1, *2

※) The saturation current value (Idc1) is the DC current value having inductance decrease down to 30%. (at 20°C)

※) The temperature rise current value (Idc2) is the DC current value having temperature increase up to 40°C. (at 20°C)

※) The rated current is the DC current value that satisfies both of current value saturation current value and temperature rise current value.

Derating of Rated Current

NR series H type/S type/V type

Derating of current is necessary for NR-series H type/S type/V type depending on ambient temperature. Please refer to the chart shown below for appropriate derating of current.



► This catalog contains the typical specification only due to the limitation of space. When you consider the purchase of our products, please check our product specification sheets. For details of each product (characteristics graph, reliability information, precautions for use, and so on), see our website (<http://www.ty-top.com/>).

Derating of Rated Current

NR series H type/S type/V type

Derating of current is necessary for NR-series H type/S type/V type depending on ambient temperature. Please refer to the chart shown below for appropriate derating of current.

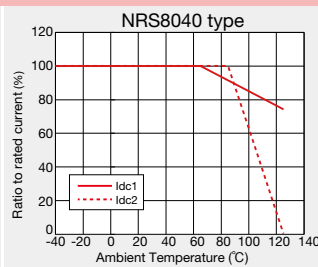
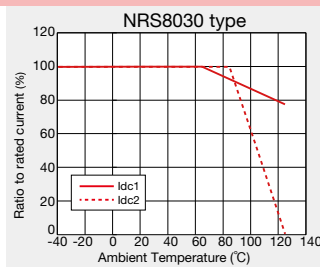
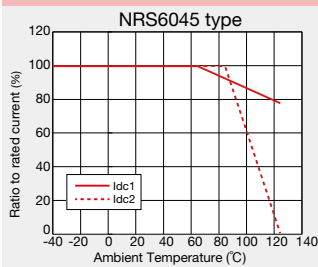
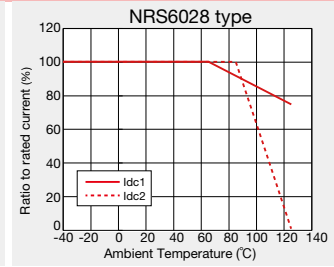
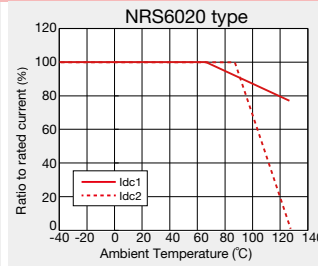
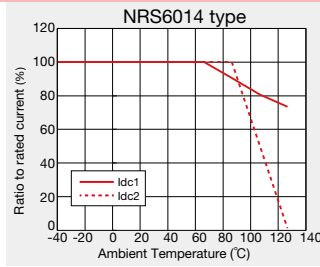
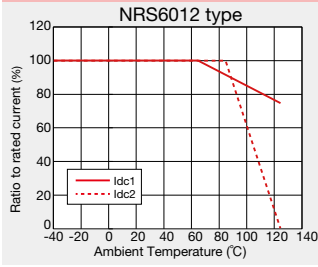

► This catalog contains the typical specification only due to the limitation of space. When you consider the purchase of our products, please check our product specification sheets. For details of each product (characteristics graph, reliability information, precautions for use, and so on), see our website (<http://www.ty-top.com/>).

SMD POWER INDUCTORS (NR SERIES/NR SERIES H TYPE/M TYPE/S TYPE/V TYPE)

PACKAGING

① Minimum Quantity

Type	Standard Quantity [pcs]
	Tape & Reel
NRV2010	2500
NRS2012	2500
NRV2012	2500
NRH2410	2500
NRH2412	2500
NR 3010	2000
NRH3010	2000
NR 3012	2000
NRH3012	2000
NRV3012	2000
NR 3015	2000
NRS3015	2000
NR 4010	5000
NRS4010	5000
NR 4012	4500
NRS4012	4500
NR 4018	3500
NRS4018	3500

Type	Standard Quantity [pcs]
	Tape & Reel
NRS5010	1000
NRS5012	1000
NRS5014	1000
NRS5020	800
NRS5024	2500
NRS5030	500
NR 5040	1500
NRS5040	1500
NRS6010	1000
NR 6012	1000
NRS6012	1000
NRS6014	1000
NR 6020	2500
NRS6020	2500
NR 6028	2000
NRS6028	2000
NR 6045	1500
NRM6045	1500
NRS6045	1500
NRS8030	1000
NR 8040	1000
NRS8040	1000

② Tape Material

● Embossed Tape

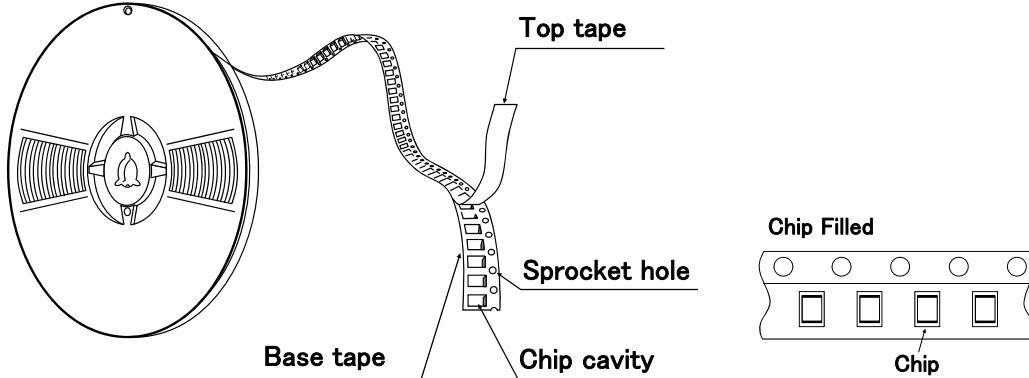

③ Taping dimensions

● Embossed tape 8mm wide (0.315 inches wide)

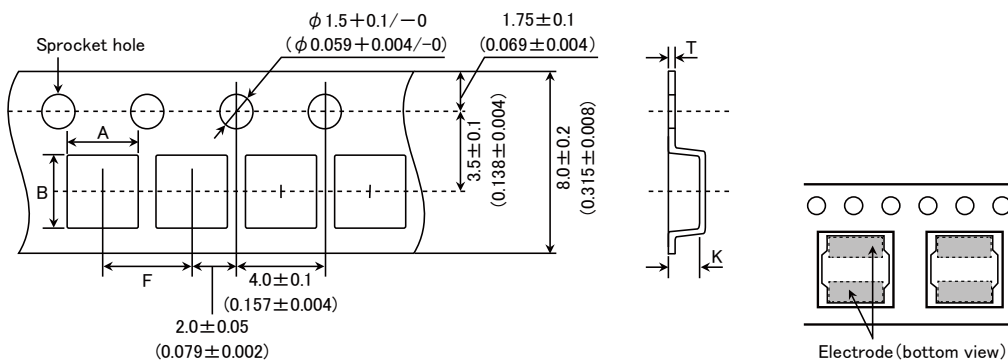

▶ This catalog contains the typical specification only due to the limitation of space. When you consider the purchase of our products, please check our specification. For details of each product (characteristics graph, reliability information, precautions for use, and so on), see our Web site (<http://www.ty-top.com/>).

Type	Chip cavity		Insertion pitch	Tape thickness	
	A	B		T	K
NRV2010	2.2±0.1 (0.102±0.004)	2.2±0.1 (0.102±0.004)	4.0±0.1 (0.157±0.004)	0.25±0.05 (0.009±0.002)	1.3±0.1 (0.051±0.004)
NRS2012 NRV2012					
NRH2410	2.6±0.1 (0.087±0.004)	2.6±0.1 (0.102±0.004)		0.25±0.05 (0.009±0.002)	1.3±0.1 (0.051±0.004)
NRH2412					
NR 3010 NRH3010	3.2±0.1 (0.126±0.004)	3.2±0.1 (0.126±0.004)		0.3±0.05 (0.012±0.002)	1.4±0.1 (0.055±0.004)
NR 3012 NRH3012 NRV3012					1.6±0.1 (0.063±0.004)
NR 3015 NRS3015					1.9±0.1 (0.075±0.004)

Unit : mm (inch)

● Embossed tape 12mm wide (0.47 inches wide)

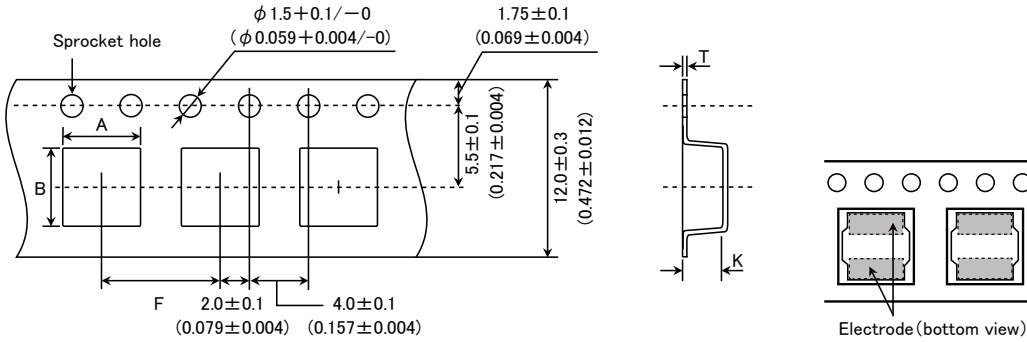

Type	Chip cavity		Insertion pitch	Tape thickness	
	A	B		T	K
NR 4010 NRS4010	4.3±0.1 (0.169±0.004)	4.3±0.1 (0.169±0.004)	8.0±0.1 (0.315±0.004)	0.3±0.1 (0.012±0.004)	1.4±0.1 (0.055±0.004)
NR 4012 NRS4012					1.6±0.1 (0.063±0.004)
NR 4018 NRS4018	2.1±0.1 (0.083±0.004)				
NRS5010	5.25±0.1 (0.207±0.004)	5.25±0.1 (0.207±0.004)		0.3±0.1 (0.012±0.004)	1.4±0.1 (0.055±0.004)
NRS5012					1.4±0.1 (0.055±0.004)
NRS5014					1.6±0.1 (0.063±0.004)
NRS5020					2.3±0.1 (0.091±0.004)
NRS5024					2.7±0.1 (0.106±0.004)
NRS5030	5.15±0.1 (0.203±0.004)	5.15±0.1 (0.203±0.004)		0.3±0.1 (0.012±0.004)	3.2±0.1 (0.126±0.004)
NR 5040 NRS5040	5.15±0.1 (0.203±0.004)	5.15±0.1 (0.203±0.004)			4.2±0.1 (0.165±0.004)
NRS6010	6.3±0.1 (0.248±0.004)	6.3±0.1 (0.248±0.004)	0.4±0.1 (0.016±0.004)	1.4±0.1 (0.055±0.004)	
NR 6012 NRS6012				1.6±0.1 (0.063±0.004)	
NRS6014				1.6±0.1 (0.063±0.004)	
NR 6020 NRS6020				2.3±0.1 (0.090±0.004)	
NR 6028 NRS6028				3.1±0.1 (0.122±0.004)	
NR 6045 NRM6045 NRS6045				4.7±0.1 (0.185±0.004)	

Unit : mm (inch)

▶ This catalog contains the typical specification only due to the limitation of space. When you consider the purchase of our products, please check our specification. For details of each product (characteristics graph, reliability information, precautions for use, and so on), see our Web site (<http://www.ty-top.com/>).

● Embossed tape 16mm wide (0.63 inches wide)

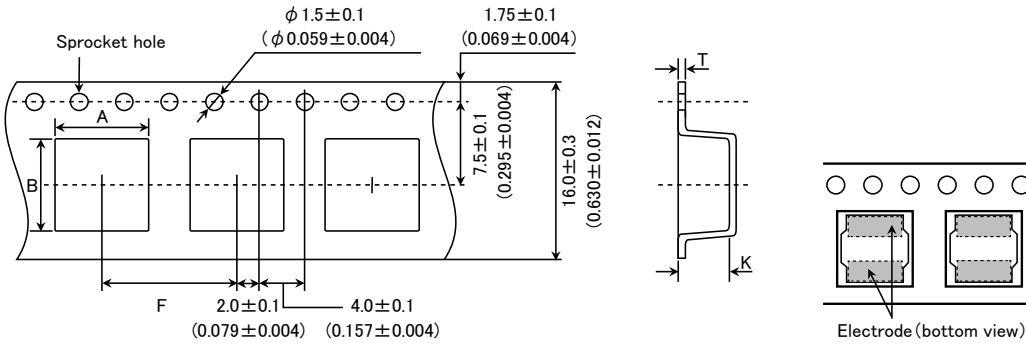

Type	Chip cavity		Insertion pitch F	Tape thickness	
	A	B		T	K
NRS8030	8.3 ± 0.1 (0.327 ± 0.004)	8.3 ± 0.1 (0.327 ± 0.004)	12.0 ± 0.1 (0.472 ± 0.004)	0.5 ± 0.1 (0.020 ± 0.004)	3.4 ± 0.1 (0.134 ± 0.004)
NR 8040 NRS8040					4.5 ± 0.1 (0.177 ± 0.004)

Unit : mm (inch)

④ Leader and Blank portion

● NR, NRH, NRS, NRV

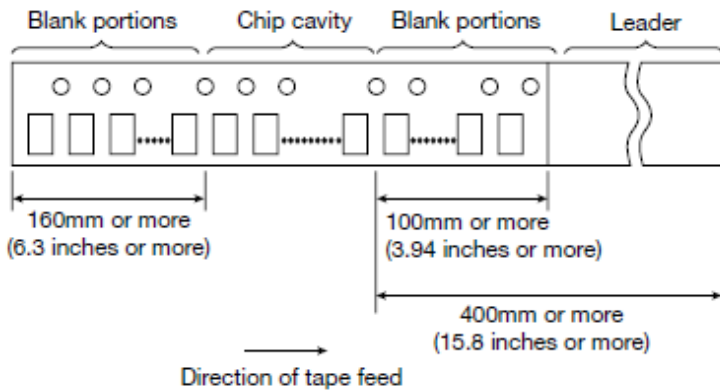

⑤ Reel size

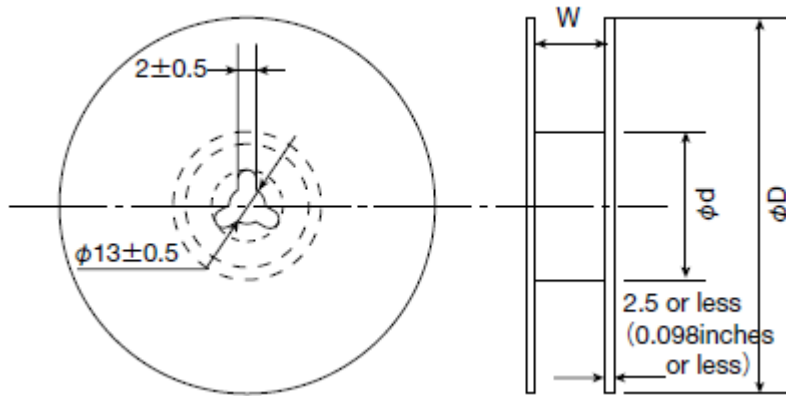

Type	Reel size (Reference values)		
	φD	φd	W
NRV2010	180 ± 0.5 (7.087 ± 0.019)	60 ± 1.0 (2.36 ± 0.04)	10.0 ± 1.5 (0.394 ± 0.059)
NRS2012			
NRV2012			
NRH2410			
NRH2412			
NR 3010			
NRH3010			
NR 3012			
NRH3012			
NRV3012			
NR 3015	180 ± 0.5 (7.087 ± 0.019)	60 ± 1.0 (2.36 ± 0.04)	10.0 ± 1.5 (0.394 ± 0.059)
NRS3015			

▶ This catalog contains the typical specification only due to the limitation of space. When you consider the purchase of our products, please check our specification. For details of each product (characteristics graph, reliability information, precautions for use, and so on), see our Web site (<http://www.ty-top.com/>).

NRS5010	180±3.0 (7.087±0.118)	60±2.0 (2.36±0.08)	14.0±1.5 (0.551±0.059)
NRS5012			
NRS5014			
NRS5020			
NRS5030			
NRS6010			
NR 6012			
NRS6012			
NRS6014			

Unit : mm (inch)

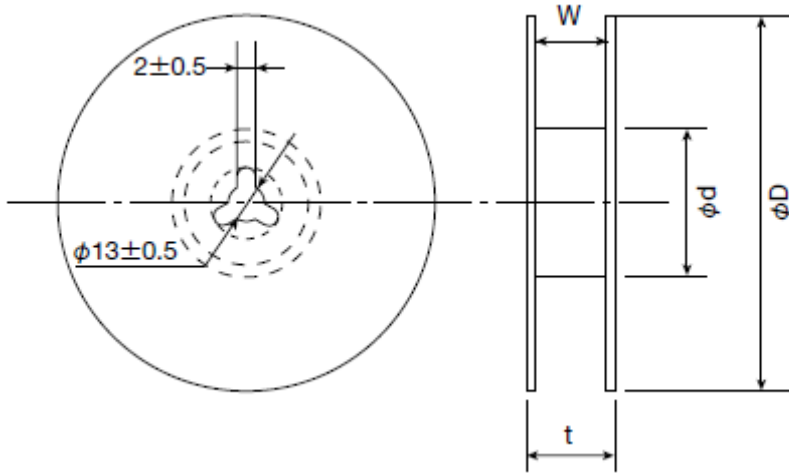

Type	Reel size (Reference values)			
	φD	φd	t (max.)	W
NR 4010	330±3.0 (12.99±0.118)	80±2.0 (3.15±0.078)	18.5 (0.72)	13.5±1.0 (0.531±0.04)
NRS4010				
NR 4012				
NRS4012				
NR 4018				
NRS4018				
NRS5024				
NR 5040				
NRS5040				
NR 6020				
NRS6020				
NR 6028				
NRS6028				
NR 6045				
NRM6045				
NRS6045				
NRS8030	22.5 (0.89)	17.5±1.0 (0.689±0.04)		
NR 8040				
NRS8040				

Unit : mm (inch)

⑥ Top Tape Strength

The top tape requires a peel-off force of 0.1 to 1.3N in the direction of the arrow as illustrated below.

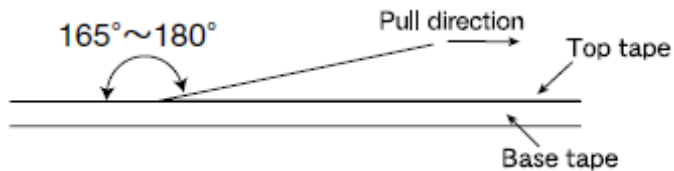

SMD POWER INDUCTORS (NR□ SERIES)

RELIABILITY DATA

1. Operating Temperature Range														
Specified Value	NRV20/30Type, NRH24/30Type NRS20/30/40/50/60/80Type	-40~+125°C (Including self-generated heat)												
Test Methods and Remarks	Including self-generated heat													
2. Storage Temperature Range														
Specified Value	NRV20/30Type, NRH24/30Type NRS20/30/40/50/60/80Type	-40~+85°C												
Test Methods and Remarks	-5 to 40°C for the product with taping.													
3. Rated current														
Specified Value	NRV20/30Type, NRH24/30Type NRS20/30/40/50/60/80Type	Within the specified tolerance												
4. Inductance														
Specified Value	NRV20/30Type, NRH24/30Type NRS20/30/40/50/60/80Type	Within the specified tolerance												
Test Methods and Remarks	Measuring equipment : LCR Meter (HP 4285A or equivalent) Measuring frequency : 100kHz, 1V													
5. DC Resistance														
Specified Value	NRV20/30Type, NRH24/30Type NRS20/30/40/50/60/80Type	Within the specified tolerance												
Test Methods and Remarks	Measuring equipment : DC ohmmeter (HIOKI 3227 or equivalent)													
6. Self resonance frequency														
Specified Value	NRV30Type, NRH24/30Type NRS30/40/50/60/80Type	Within the specified tolerance												
	NRV20, NRS20	—												
Test Methods and Remarks	NRV30, NRH24/30, NRS30/40/50/60/80Type Measuring equipment : Impedance analyzer/material analyzer (HP4291A or equivalent HP4191A, 4192A or equivalent)													
7. Temperature characteristic														
Specified Value	NRV20/30Type, NRH24/30Type NRS20/30/40/50/60/80Type	Inductance change : Within ±20%												
Test Methods and Remarks	NRV20/30, NRH24/30, NRS20/30/40/50/60/80 Type, : Measurement of inductance shall be taken at temperature range within -40°C~+85°C. With reference to inductance value at +20°C., change rate shall be calculated.													
	Change of maximum inductance deviation in step 1 to 5													
	<table border="1"> <thead> <tr> <th>Step</th> <th>Temperature (°C)</th> </tr> </thead> <tbody> <tr> <td>1</td> <td>20</td> </tr> <tr> <td>2</td> <td>Minimum operating temperature</td> </tr> <tr> <td>3</td> <td>20 (Standard temperature)</td> </tr> <tr> <td>4</td> <td>Maximum operating temperature</td> </tr> <tr> <td>5</td> <td>20</td> </tr> </tbody> </table>	Step	Temperature (°C)	1	20	2	Minimum operating temperature	3	20 (Standard temperature)	4	Maximum operating temperature	5	20	
Step	Temperature (°C)													
1	20													
2	Minimum operating temperature													
3	20 (Standard temperature)													
4	Maximum operating temperature													
5	20													

▶ This catalog contains the typical specification only due to the limitation of space. When you consider the purchase of our products, please check our specification.
For details of each product (characteristics graph, reliability information, precautions for use, and so on), see our Web site (<http://www.ty-top.com/>).

8. Resistance to flexure of substrate

Specified Value	NRV20/30Type,NRH24/30Type NRS20/30/40/50/60/80Type	No damage
-----------------	---	-----------

The test samples shall be soldered to the test board by the reflow. As illustrated below, apply force in the direction of the arrow indicating until deflection of the test board reaches to 2 mm.

Test board size : 100 × 40 × 1.0
 Test board material : glass epoxy-resin
 Solder cream thickness : 0.10mm (NRS20/30, NRH24/30, NRV20/30Type)
 : 0.15mm (NRS40/50/60/80Type)

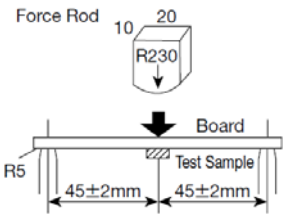

Land dimension

Type	A	B	C
NRS20, NRV20	0.65	0.7	2.0
NRH24	0.7	0.75	2.0
NRV30,NRH30,NRS30	0.8	1.4	2.7
NRS40	1.2	1.6	3.7
NRS50	1.5	2.1	4.0
NRS60	1.6	3.1	5.7
NRS80	1.8	3.8	7.5

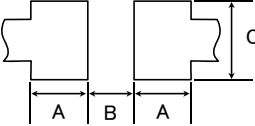

9. Insulation resistance : between wires

Specified Value	NRV20/30Type,NRH24/30Type NRS20/30/40/50/60/80Type	—
-----------------	---	---

10. Insulation resistance : between wire and core

Specified Value	NRV20/30Type,NRH24/30Type NRS20/30/40/50/60/80Type	—
-----------------	---	---

11. Withstanding voltage : between wire and core

Specified Value	NRV20/30Type,NRH24/30Type NRS20/30/40/50/60/80Type	—
-----------------	---	---

12. Adhesion of terminal electrode

Specified Value	NRV20/30Type,NRH24/30Type NRS20/30/40/50/60/80Type	Shall not come off PC board
-----------------	---	-----------------------------

The test samples shall be soldered to the test board by the reflow.

Applied force : 10N to X and Y directions.
 Duration : 5s.
 Solder cream thickness : 0.10mm (NRV20/30Type,NRH24/30type,NRS20/30Type)
 : 0.15mm (NRS40/50/60/80Type)

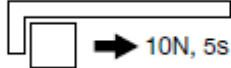

13. Resistance to vibration

Specified Value	NRV20/30Type,NRH24/30Type NRS20/30/40/50/60/80Type	Inductance change : Within ±10% No significant abnormality in appearance.
-----------------	---	--

The test samples shall be soldered to the test board by the reflow.
 Then it shall be submitted to below test conditions.

Frequency Range	10~55Hz
Total Amplitude	1.5mm (May not exceed acceleration 196m/s ²)
Sweeping Method	10Hz to 55Hz to 10Hz for 1min.
Time	X
	Y
	Z

For 2 hours on each X, Y, and Z axis.

Recovery : At least 2hrs of recovery under the standard condition after the test, followed by the measurement within 48hrs.

▶ This catalog contains the typical specification only due to the limitation of space. When you consider the purchase of our products, please check our specification. For details of each product (characteristics graph, reliability information, precautions for use, and so on), see our Web site (<http://www.ty-top.com/>) .

14. Solderability																			
Specified Value	NRV20/30Type,NRH24/30Type NRS20/30/40/50/60/80Type	At least 90% of surface of terminal electrode is covered by new solder.																	
Test Methods and Remarks	The test samples shall be dipped in flux, and then immersed in molten solder as shown in below table. Flux : Methanol solution containing rosin 25%.																		
	<table border="1"> <tr> <td>Solder Temperature</td> <td>245±5°C</td> </tr> <tr> <td>Time</td> <td>5±1.0 sec.</td> </tr> </table>	Solder Temperature	245±5°C	Time	5±1.0 sec.	※Immersion depth : All sides of mounting terminal shall be immersed.													
Solder Temperature	245±5°C																		
Time	5±1.0 sec.																		
15. Resistance to soldering heat																			
Specified Value	NRV20/30Type,NRH24/30Type NRS20/30/40/50/60/80Type	Inductance change : Within ±10% No significant abnormality in appearance.																	
Test Methods and Remarks	The test sample shall be exposed to reflow oven at 230±5°C for 40 seconds, with peak temperature at 260±5°C for 5 seconds, 2 times. Test board material : glass epoxy-resin Test board thickness : 1.0mm																		
16. Thermal shock																			
Specified Value	NRV20/30Type,NRH24/30Type NRS20/30/40/50/60/80Type	Inductance change : Within ±10% No significant abnormality in appearance.																	
Test Methods and Remarks	The test samples shall be soldered to the test board by the reflow. The test samples shall be placed at specified temperature for specified time by step 1 to step 4 as shown in below table in sequence. The temperature cycle shall be repeated 1000 cycles.																		
	<table border="1"> <thead> <tr> <th colspan="3">Conditions of 1 cycle</th> </tr> <tr> <th>Step</th> <th>Temperature (°C)</th> <th>Duration (min)</th> </tr> </thead> <tbody> <tr> <td>1</td> <td>-40±3</td> <td>30±3</td> </tr> <tr> <td>2</td> <td>Room temperature</td> <td>Within 3</td> </tr> <tr> <td>3</td> <td>+85±2</td> <td>30±3</td> </tr> <tr> <td>4</td> <td>Room temperature</td> <td>Within 3</td> </tr> </tbody> </table>		Conditions of 1 cycle			Step	Temperature (°C)	Duration (min)	1	-40±3	30±3	2	Room temperature	Within 3	3	+85±2	30±3	4	Room temperature
Conditions of 1 cycle																			
Step	Temperature (°C)	Duration (min)																	
1	-40±3	30±3																	
2	Room temperature	Within 3																	
3	+85±2	30±3																	
4	Room temperature	Within 3																	
17. Damp heat																			
Specified Value	NRV20/30Type,NRH24/30Type NRS20/30/40/50/60/80Type	Inductance change : Within ±10% No significant abnormality in appearance.																	
Test Methods and Remarks	The test samples shall be soldered to the test board by the reflow. The test samples shall be placed in thermostatic oven set at specified temperature and humidity as shown in below table.																		
	<table border="1"> <tr> <td>Temperature</td> <td>60±2°C</td> </tr> <tr> <td>Humidity</td> <td>90~95%RH</td> </tr> <tr> <td>Time</td> <td>1000+24/-0 hour</td> </tr> </table>	Temperature	60±2°C	Humidity	90~95%RH	Time	1000+24/-0 hour												
Temperature	60±2°C																		
Humidity	90~95%RH																		
Time	1000+24/-0 hour																		
18. Loading under damp heat																			
Specified Value	NRV20/30Type,NRH24/30Type NRS20/30/40/50/60/80Type	Inductance change : Within ±10% No significant abnormality in appearance.																	
Test Methods and Remarks	The test samples shall be soldered to the test board by the reflow. The test samples shall be placed in thermostatic oven set at specified temperature and humidity and applied the rated current continuously as shown in below table.																		
	<table border="1"> <tr> <td>Temperature</td> <td>60±2°C</td> </tr> <tr> <td>Humidity</td> <td>90~95%RH</td> </tr> <tr> <td>Applied current</td> <td>Rated current</td> </tr> <tr> <td>Time</td> <td>1000+24/-0 hour</td> </tr> </table>	Temperature	60±2°C	Humidity	90~95%RH	Applied current	Rated current	Time	1000+24/-0 hour										
Temperature	60±2°C																		
Humidity	90~95%RH																		
Applied current	Rated current																		
Time	1000+24/-0 hour																		
19. Low temperature life test																			
Specified Value	NRV20/30Type,NRH24/30Type NRS20/30/40/50/60/80Type	Inductance change : Within ±10% No significant abnormality in appearance.																	
Test Methods and Remarks	The test samples shall be soldered to the test board by the reflow. After that, the test samples shall be placed at test conditions as shown in below table.																		
	<table border="1"> <tr> <td>Temperature</td> <td>-40±2°C</td> </tr> <tr> <td>Time</td> <td>1000+24/-0 hour</td> </tr> </table>	Temperature	-40±2°C	Time	1000+24/-0 hour														
Temperature	-40±2°C																		
Time	1000+24/-0 hour																		

▶ This catalog contains the typical specification only due to the limitation of space. When you consider the purchase of our products, please check our specification.
For details of each product (characteristics graph, reliability information, precautions for use, and so on), see our Web site (<http://www.ty-top.com/>).

20. High temperature life test

Specified Value	NRV20/30Type,NRH24/30Type NRS20/30/40/50/60/80Type	—
-----------------	---	---

21. Loading at high temperature life test

Specified Value	NRV20/30Type,NRH24/30Type NRS20/30/40/50/60/80Type	Inductance change : Within $\pm 10\%$ No significant abnormality in appearance.
-----------------	---	--

Test Methods and Remarks	The test samples shall be soldered to the test board by the reflow soldering.	
	Temperature	$85 \pm 2^\circ\text{C}$
	Applied current	Rated current
	Time	$1000 + 24 / - 0$ hour

22. Standard condition

Specified Value	NRV20/30Type,NRH24/30Type NRS20/30/40/50/60/80Type	Standard test condition : Unless otherwise specified, temperature is $20 \pm 15^\circ\text{C}$ and $65 \pm 20\%$ of relative humidity. When there is any question concerning measurement result: In order to provide correlation data, the test shall be condition of $20 \pm 2^\circ\text{C}$ of temperature, $65 \pm 5\%$ relative humidity. Inductance is in accordance with our measured value.
-----------------	---	--

SMD POWER INDUCTORS (NR, NS, ES SERIES)

PRECAUTIONS

1. Circuit Design

Precautions	<p>◆ Operating environment</p> <p>1. The products listed in this catalogue are intended for use in general electronic equipment (e.g., AV equipment, OA equipment, home electric appliances, office equipment, information and communication equipment), general medical equipment, industrial equipment, and automotive interior applications, etc.</p> <p>Please be sure to contact TAIYO YUDEN for further information before using the products for any equipment which may directly cause loss of human life or bodily injury (e.g., specially controlled medical equipment, transportation equipment including, without limitation, automotive powertrain control system, train control system, and ship control system, traffic signal equipment).</p> <p>Please do not incorporate our products into any equipment requiring high levels of safety and/or reliability (e.g., aerospace equipment, aviation equipment, nuclear control equipment, undersea equipment, military equipment, etc.).</p>
-------------	---

2. PCB Design

Precautions	<p>◆ Land pattern design</p> <ol style="list-style-type: none"> Please refer to a recommended land pattern. There is stress, which has been caused by distortion of a PCB, to the inductor. (NRV20/30, NRH24/30, NRS20/30/40/50/60/80, NRM60 Type) Please consider the arrangement of parts on a PCB. (NRV20/30, NRH24/30, NRS20/30/40/50/60/80, NRM60 Type)
-------------	---

Technical considerations	<p>◆ Land pattern design</p> <p>Surface Mounting</p> <ol style="list-style-type: none"> Mounting and soldering conditions should be checked beforehand. Applicable soldering process to this products is reflow soldering only. Please use the recommended land pattern shown as below. Electrical characteristics and the mounting ability of the product are being considered in the recommended land pattern. If a PCB is designed with other dimensions, defective soldering and stress to a product may occur due to misalignment. The performance of the product may not be brought out. If an adopted land pattern is different from the recommended land pattern, stress to the product will increase. It may cause cracks or defective electrical characteristics of the product. Please conduct validation completely before studying adoption of this product and please judge the pros and cons of adoption of this product with taking on responsibility. (NR30/40/50/60/80, NRV20/30, NRH24/30, NRS20/30/40/50/60/80, NRM60 Type) As coefficients of thermal expansion between an inductor and a PCB differs, cracks may occur on a ferrite core when thermal stress is applied to them after mounting an inductor. (Please refer to the drawings below.) Please conduct validation completely before studying adoption of this product and please judge the pros and cons of adoption of this product with taking on responsibility. (NRV20/30, NRH24/30, NRS20/30/40/50/60/80, NRM60 Type)
--------------------------	--

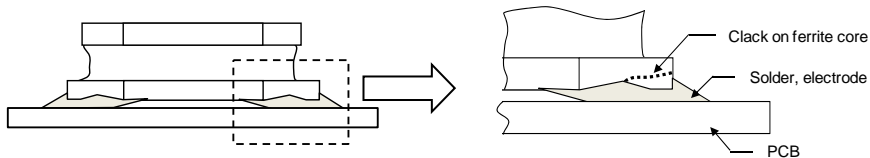

- SMD inductors should be located to minimize any possible mechanical stresses from board warp or deflection. When splitting the PCB after mounting inductors and other components, care is required so as not to give any stresses of deflection or twisting to the board. (NRV20/30, NRH24/30, NRS20/30/40/50/60/80, NRM60 Type)

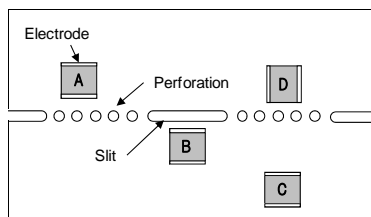

A product tends to undergo stress in order "A>C>B≡D".
Please consider the layouts of a product to minimize any stresses.

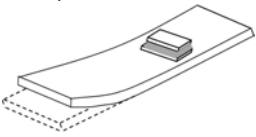
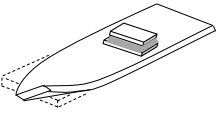
3. Considerations for automatic placement	
Precautions	<p>◆Adjustment of mounting machine</p> <ol style="list-style-type: none"> Excessive impact load should not be imposed on the products when mounting onto the PC boards. Mounting and soldering conditions should be checked beforehand.
Technical considerations	<p>◆Adjustment of mounting machine</p> <ol style="list-style-type: none"> When installing products, care should be taken not to apply distortion stress as it may deform the products. Stress may be applied to a product with a warp or a twist in handling of the product. Please conduct validation completely before studying adoption of this product and please judge the pros and cons of adoption of this product with taking on responsibility. (NRV20/30, NRH24/30, NRS20/30/40/50/60/80, NRM60 Type) <div style="display: flex; justify-content: space-around; align-items: center;"> <div style="text-align: center;"> <p><Wrap></p>  </div> <div style="text-align: center;"> <p><Twist></p>  </div> </div>

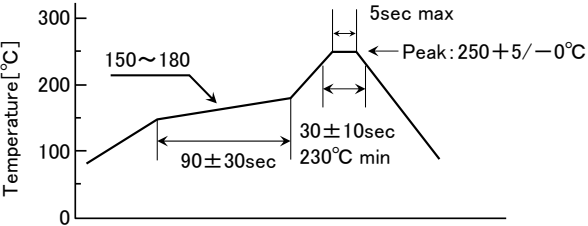
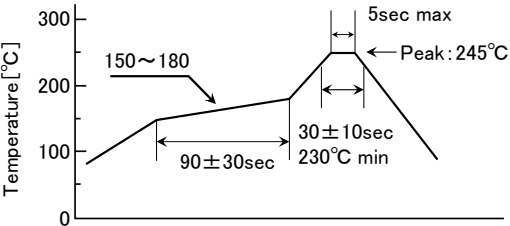
4. Soldering	
Precautions	<p>◆Reflow soldering</p> <ol style="list-style-type: none"> Please contact any of our offices for a reflow soldering, and refer to the recommended condition specified. The product shall be used reflow soldering only. Please do not add any stress to a product until it returns in normal temperature after reflow soldering. <p>◆Lead free soldering</p> <ol style="list-style-type: none"> When using products with lead free soldering, we request to use them after confirming adhesion, temperature of resistance to soldering heat, soldering etc sufficiently. <p>◆Recommended conditions for using a soldering iron</p> <ul style="list-style-type: none"> Put the soldering iron on the land-pattern. Soldering iron's temperature - Below 350°C Duration - 3 seconds or less The soldering iron should not directly touch the inductor.
Technical considerations	<p>◆Reflow soldering</p> <ol style="list-style-type: none"> If products are used beyond the range of the recommended conditions, heat stresses may deform the products, and consequently degrade the reliability of the products. <ul style="list-style-type: none"> NRV20/30, NRH24/30, NRS20/30/40/50/60/80, NRM60 Type, NS101/125 Type, EST0645/1040/1060 Type Recommended reflow condition (Pb free solder) <u>NR, NS Series</u> <div style="display: flex; justify-content: space-around;"> <div style="text-align: center;">  </div> <div style="text-align: center;">  </div> </div>

5. Cleaning	
Precautions	<p>◆Cleaning conditions</p> <ol style="list-style-type: none"> Washing by supersonic waves shall be avoided.
Technical considerations	<p>◆Cleaning conditions</p> <ol style="list-style-type: none"> If washed by supersonic waves, the products might be broken.

6. Handling

▶ This catalog contains the typical specification only due to the limitation of space. When you consider the purchase of our products, please check our specification. For details of each product (characteristics graph, reliability information, precautions for use, and so on), see our Web site (<http://www.ty-top.com/>)

Precautions	<ul style="list-style-type: none"> ◆ Handling <ol style="list-style-type: none"> 1. Keep the product away from all magnets and magnetic objects. ◆ Breakaway PC boards (splitting along perforations) <ol style="list-style-type: none"> 1. When splitting the PC board after mounting product, care should be taken not to give any stresses of deflection or twisting to the board. 2. Board separation should not be done manually, but by using the appropriate devices. ◆ Mechanical considerations <ol style="list-style-type: none"> 1. Please do not give the product any excessive mechanical shocks. 2. Please do not add any shock and power to a product in transportation. ◆ Pick-up pressure <ol style="list-style-type: none"> 1. Please do not push to add any pressure to a winding part. Please do not give any shock and push into a ferrite core exposure part. ◆ Packing <ol style="list-style-type: none"> 1. Please avoid accumulation of a packing box as much as possible.
Technical considerations	<ul style="list-style-type: none"> ◆ Handling <ol style="list-style-type: none"> 1. There is a case that a characteristic varies with magnetic influence. ◆ Breakaway PC boards (splitting along perforations) <ol style="list-style-type: none"> 1. The position of the product on PCBs shall be carefully considered to minimize the stress caused from splitting of the PCBs. ◆ Mechanical considerations <ol style="list-style-type: none"> 1. There is a case to be damaged by a mechanical shock. 2. There is a case to be broken by the handling in transportation. ◆ Pick-up pressure <ol style="list-style-type: none"> 1. Damage and a characteristic can vary with an excessive shock or stress. ◆ Packing <ol style="list-style-type: none"> 1. If packing boxes are accumulated, that could cause a deformation on packing tapes or a damage on the products.

7. Storage conditions

Precautions	<ul style="list-style-type: none"> ◆ Storage <ol style="list-style-type: none"> 1. To maintain the solderability of terminal electrodes and to keep the packing material in good condition, temperature and humidity in the storage area should be controlled. <ul style="list-style-type: none"> ▪ Recommended conditions <ul style="list-style-type: none"> Ambient temperature : $-5\sim 40^{\circ}\text{C}$ Humidity : Below 70% RH ▪ The ambient temperature must be kept below 30°C. Even under ideal storage conditions, solderability of products electrodes may decrease as time passes. <ul style="list-style-type: none"> For this reason, product should be used within 6 months from the time of delivery. In case of storage over 6 months, solderability shall be checked before actual usage.
Technical considerations	<ul style="list-style-type: none"> ◆ Storage <ol style="list-style-type: none"> 1. Under a high temperature and humidity environment, problems such as reduced solderability caused by oxidation of terminal electrodes and deterioration of taping/packaging materials may take place.

X-ON Electronics

Largest Supplier of Electrical and Electronic Components

Click to view similar products for [Fixed Inductors](#) category:

Click to view products by [Taiyo Yuden](#) manufacturer:

Other Similar products are found below :

[CR32NP-151KC](#) [CR32NP-180KC](#) [CR32NP-181KC](#) [CR32NP-1R5MC](#) [CR32NP-390KC](#) [CR32NP-3R9MC](#) [CR32NP-680KC](#) [CR32NP-820KC](#) [CR32NP-8R2MC](#) [CR43NP-390KC](#) [CR43NP-560KC](#) [CR43NP-680KC](#) [CR54NP-181KC](#) [CR54NP-470LC](#) [CR54NP-820KC](#) [CR54NP-8R5MC](#) [70F224AI](#) [MGDQ4-00004-P](#) [MHL1ECTTP18NJ](#) [MHQ1005P10NJ](#) [MHQ1005P1N0S](#) [MHQ1005P2N4S](#) [MHQ1005P3N6S](#) [MHQ1005P5N1S](#) [MHQ1005P8N2J](#) [PE-51506NL](#) [PE-53601NL](#) [PE-53602NL](#) [PE-53630NL](#) [PE-53824SNLT](#) [PE-92100NL](#) [PG0434.801NLT](#) [PG0936.113NLT](#) [9220-20](#) [9310-16](#) [PM06-2N7](#) [PM06-39NJ](#) [A01TK](#) [1206CS-471XJ](#) [HC2LP-R47-R](#) [HC2-R47-R](#) [HC3-2R2-R](#) [HCF1305-3R3-R](#) [1206CS-151XG](#) [RCH664NP-140L](#) [RCH664NP-4R7M](#) [RCH8011NP-221L](#) [RCP1317NP-332L](#) [RCP1317NP-391L](#) [RCR1010NP-470M](#)