

Wireless Module
802.11ac/a/b/g/n + *Bluetooth*[®] 4.2

WYSAGVDXG , WBSAGVDXG
& WKSAGVDXG

Overview

May, 2019 Version 1.0

WYSAGVDXG : 802.11ac 1x1+ *Bluetooth*® v4.2 Module

Features

- Supports IEEE802.11ac/a/b/g/n + *Bluetooth* v4.2
- Featuring Marvell 88W8887
- Transmit speed:
11/5.5/2/1 Mbps(11b), 54/48/36/24/18/12/9/6 Mbps(11a/g),
150~6.5 Mbps (11n, MCS7~0, HT20/40),
7.22~433.3 Mbps (11ac MCS9~0, VHT80)
- Interface: SDIO
- Built-in Diplexer, 2G-PA, 5G-PA, 5G-LNA, OTP, RF Clock & DC/DC Power
- Security: TKIP, WEP, AES, CCMP, CMAC, WAPI, WPA/WPA2(64bit/128bit)
- Outline: 24.0 x 11.5 x 2.0 (Max) mm, SMD Type, Metal case shielding
- On-board Dual Band Chip Antenna
- Certification: FCC, ISED and MIC Regulation
- ETSI EN 300 328 / EN301 893 v2.1.1 conducted test report available
- RoHS Compliant

Block Diagram

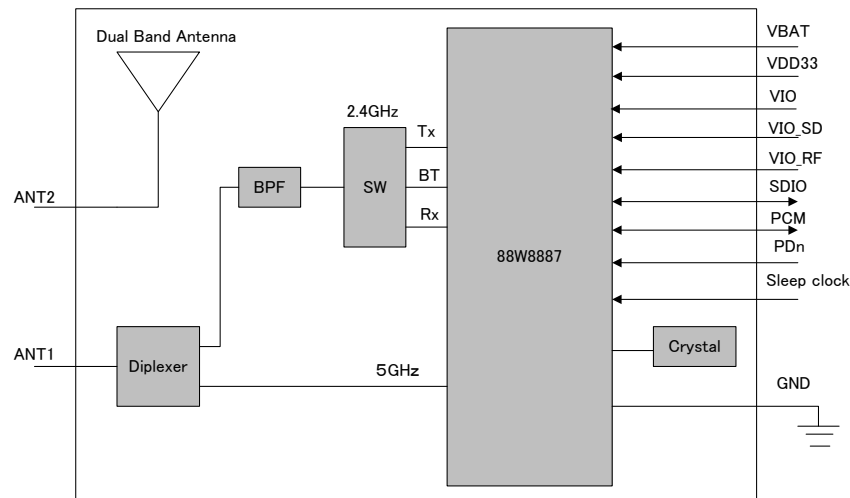

General Electrical Specification

Parameter	Description	Min.	Typ.	Max.	Units
Frequency Range	11b / g / n (HT20/HT40)	2412		2472	MHz
	11a/n / ac (HT20/HT40/HT80)	5180		5825	MHz
	BT/BLE	2402		2480	MHz
Operation Voltage	VDD33	3.0	3.3	3.6	V
	VIO	1.62/3.0	1.8/3.3	1.98/3.6	
TX Output Power	11b/11g/11n-2G(HT20/HT40)	10/10/10/8	12/12/12/10	14/14/14/12	dBm
	11a/n-5G(HT20/HT40)/ac (VHT80)	10/10/8/6	12/12/10/8	14/14/12/10	
	BT/BLE	-6/-6	0/0	2/2	
RX Sensitivity	11b/11g/11n-2G(HT20/HT40)	-	-87/-73/-69/-66	-76/-65/-64/-61	dBm
	11a/n-5G(HT20/HT40)/ac (VHT80)	-	-71/-68/-65/-57	-65/-64/-61/-51	
	BT / BLE	-	-86/-86	-70/-70	
Power Consumption	Burst Mode TX 11b (Duty=46.8%)	-	488		mW
	11ac RX 5G		358		mW
	Sleep Mode		1.8		mW
General Operation Temperature Range (Shielding case surface temperature)		-30	25	85	deg-C

Outline

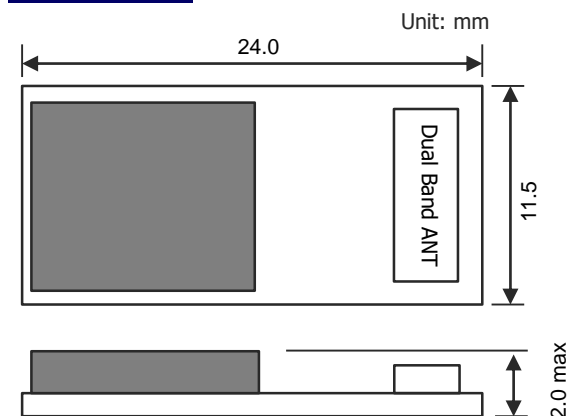

Note: The *Bluetooth*® word mark and logos are owned by the *Bluetooth* SIG, Inc. and any use of such marks by TAIYO YUDEN CO.,LTD. is under license.

TAIYO YUDEN

WBSAGVDXG: Wireless LAN Module Evaluation Board

To Evaluate WLAN Module WYSAGVDXG
You Will Need WBSAGVDXG

WBSAGVDXG is the evaluation board for WLAN Module **WYSAGVDXG**. This board has everything you need to evaluate the performance of this module.

WBSAGVDXG Board includes:

No.	Item	Description	Qty
1	WBSAGVDXG	Evaluation Board for WLAN module WYSAGVDXG with SDIO interface	1
2	Red & Blue Cable	Power Supply Cable	1

1 WBSAGVDXG

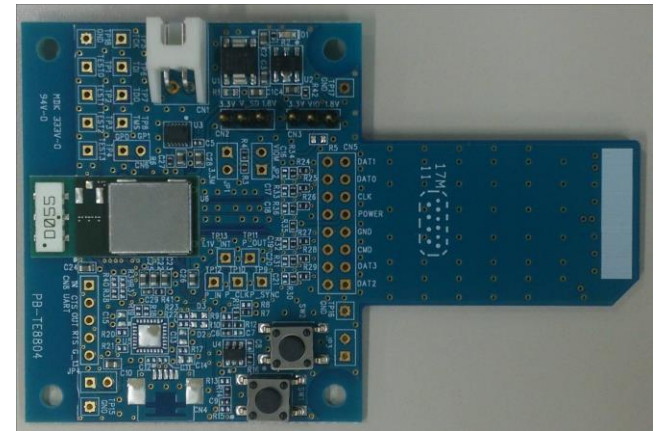

2 Red & Blue Cable



Supplemental Product Information

WLAN Module Operating Environment

- PC with Linux Fedora18 with software development option and SDIO interface

Attention: PC with SDIO is required. Although SDIO and SD Memory Card have the same slot shape, they are not compatible. WLAN Module and Evaluation Board will not work if they are connected to SD memory card slot.

What will be provided if the Evaluation Board (WBSAGVDXG) is purchased

- Lab-tool User Guide: RF Control Tool Guide
- Lab-tool: RF Control Tool
- WLAN Device Driver Software for Linux PC, Fedora18

Attention: There is a possibility that export control could limit customer's access WLAN Device Driver and the API Specification depending on the customer's country or application.

Attention: WYSAGVDXG (not WBSAGVDXG) provided by web distributor is not bundled any above documents and software. To get them, you need to purchase WBSAGVDXG (Evaluation Board).

If there is no PC with SDIO, Evaluation Kit(WKSAGVDXG) is recommended.

- ESPRESSObin(ARM Cortex A53) is attached. It can be used instead of PC

Attention: There is a possibility that export control could limit customer's access WLAN Device Driver and the API Specification depending on the customer's country or application.

Anyone can access other documents at the following site:

English: <http://www.yuden.co.jp/ut/product/category/module/WYSAGVDXG.html>

Japanese: <http://www.yuden.co.jp/jp/product/category/module/WYSAGVDXG.html>

Example of hardware configuration for WBSAGVDXG

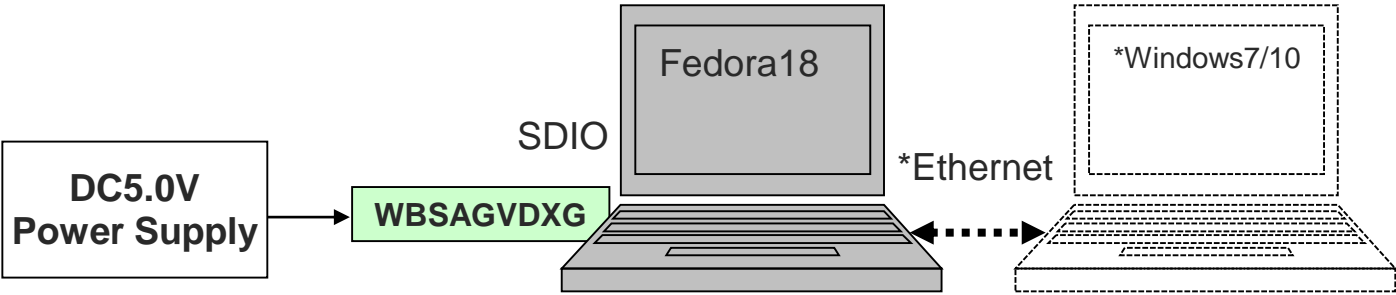

*To use LABTOOL, PC with Windows7/10 is also required.
Each PCs are connected via Ethernet cable.

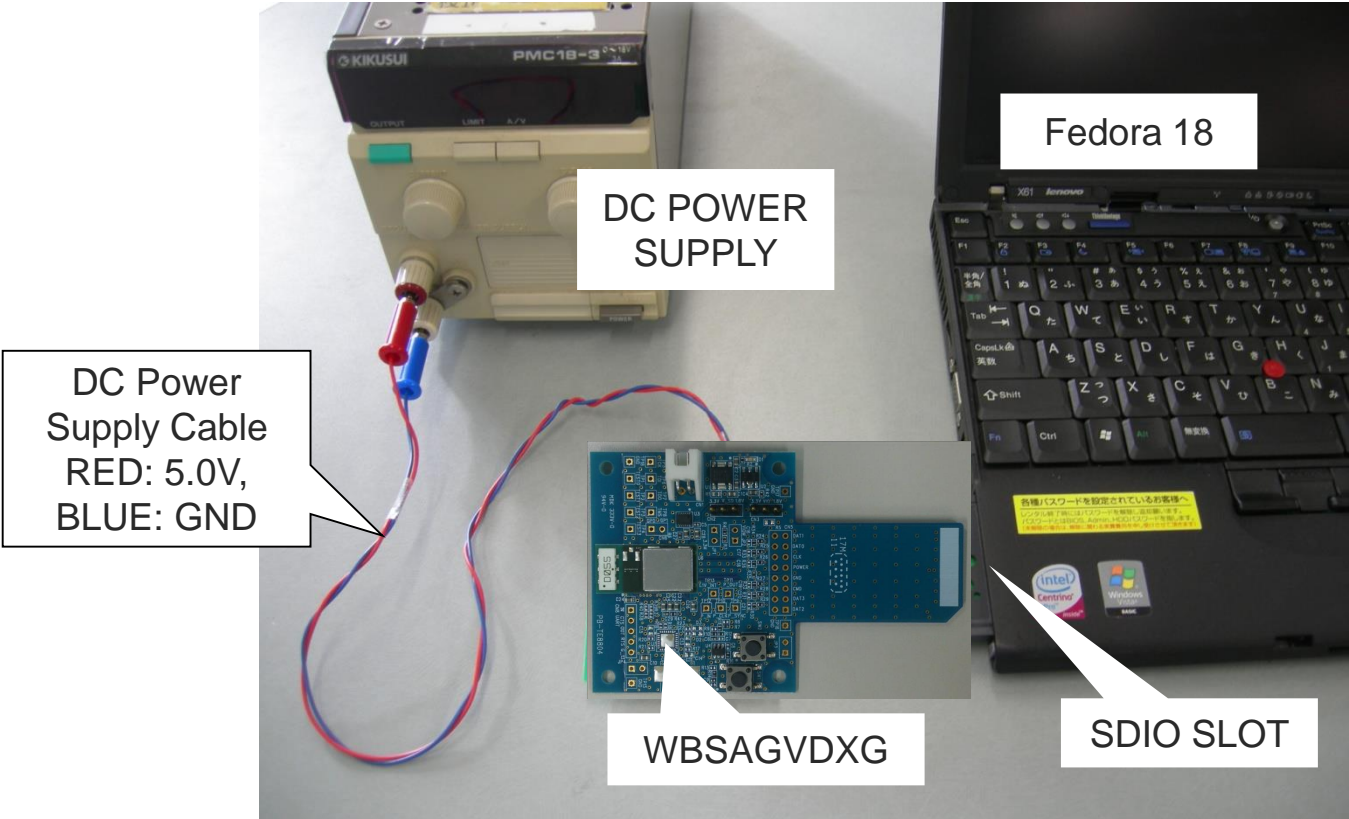

Software Structure

Sample Application

- uaputl , mlanutl (Configuration tools)

WLAN Device driver

- Data path:
Communicate data such as TCP or UDP
- 11bg config/11ac config/11n config:
Configure the such as CH/Rate/band/mode
- Supplicant config:
Configure the generated key by supplicant of middleware
- Infra/Adhoc config:
Configure the Infa or Adhoc mode
- uAP/WFD config:
Configure the uAP or WFD mode

Bluetooth Device driver

- Bluetooth driver

Firmware

- Data TX/RX:
Transmit and receive data on the air, such as TCP or UDP
- 11b/g/a/n function:
Execute the function of such as CH/Rate/Band/Mode
- E-supplicant function:
Generate the key of WPA/WPA2
- Infra/Adhoc function:
Execute the function of Infra or Adhoc mode
- uAP/WFD function:
Execute the function of uAP or WFD mode
- Bluetooth 4.2

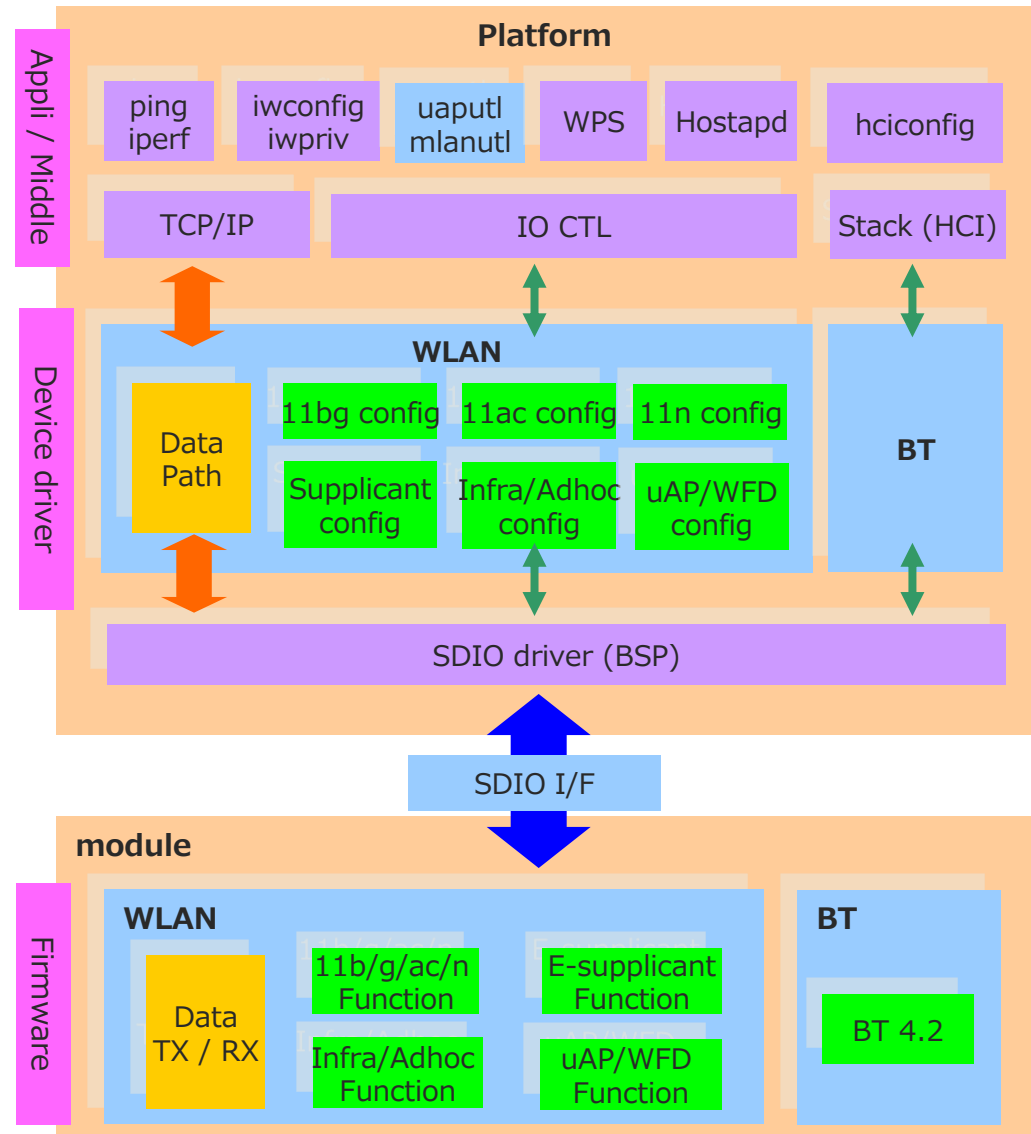

*WFD : Wi-Fi Direct , E-supplicant : Embedded supplicant

Software Feature Set

General

- 1 Spatial stream (1x1)
- 802.11b Data rates of 1,2 ,5.5 and 11 Mbps
- 802.11a/g Data rates 6 - 48, and 54 Mbps
- 802.11n Data rates up to 300 Mbps (MCS0 to 15)
- 802.11ac Data rates up to 433 Mbps (MCS0 to 9)
- 802.11d International roaming
- 802.11e QoS block ack
- 802.11h Transmit power control, DFS
- 802.11i WPA / WPA2 and 802.11X
- Infrastructure and Ad-hoc mode
- Security WEP 64 and 128-bit, TKIP and AES CCMP for WPA / WPA2
- WMM Support, WMM PS (UAPSD)
- IEEE Power Save, Auto Deep Sleep / Host Sleep
- Embedded Supplicant
- Support for TX and RX of AMPDU and AMSDU-4k packets
- Support for Only TX of AMSDU-8k packets
- Background Scan, Vendor specific IE

Access point

- Multi-BSS support (2 BSS)
- Association support up to 8 stations
- Automatic channel selection (ACS)

Simultaneous AP-STA Operation

- AP-STA functionality
- Independent security configurations on different interfaces
- Enhanced power save (AP-STA simultaneous power save)

Wi-Fi Direct/P2P

- Autonomous Group Owner mode (GO)
- P2P Client mode
- P2P Client association with WLAN AP
- P2P Client power save
- P2P Client WMM PS (UAPSD)
- GO WMM PS / IEEE PS for associated P2P clients
- 8 client support, Provision discovery

Bluetooth

- BT 4.2, BT class 2
- Adaptive frequency hopping (AFH)
- Wake on BT
- Coexistence with Wi-Fi

Driver Package

Driver package (Platform)	Software	CPU / OS Type	Content
Object package for PC	Device driver	CPU: x86 (PC) OS: Fedora 18 (Linux 3.6.10)	Driver object - Linux configuration tools - Linux WLAN and BT driver, Firmware
			Document - Install guide - Demonstration guide
	RF control tool (Lab-tool)	CPU: x86 (PC) OS: Windows and Linux	Driver object - Windows Lab-tool - Linux bridge tool, Linux driver, Firmware
			Document - User guide

Note. Source code package: Requires SLA(Software License Agreement) with Marvell or TAIYO YUDEN.

WKSAGVDXG: Wireless LAN Module Evaluation Kit

A host processor (ESPRESSObin) is attached to this kit.
It is not necessary to prepare PC with SDIO I/F.
You can use the WLAN module immediately.

WKSAGVDXG Kit includes:

No.	Item	Description	Qty
1	WBSAGVDXG	Evaluation Board for WLAN module WYSAGVDXG with SDIO interface	1
2	Red & Blue Cable	Power Supply Cable for WBSAGVDXG	1
3	ESPRESSObin	Marvell Armada 3700LP (88F3720) dual core ARM Cortex A53 processor up to 1.2GHz.	1
4	AC Adapter	Power Supply Cable for ESPRESSObin	1
5	USB Memory	For booting ESPRESSObin	1
6	USB Cable		1
7	SD – Micro SD Conversion Cable	SDIO conversion for EVB and ESPRESSObin	1

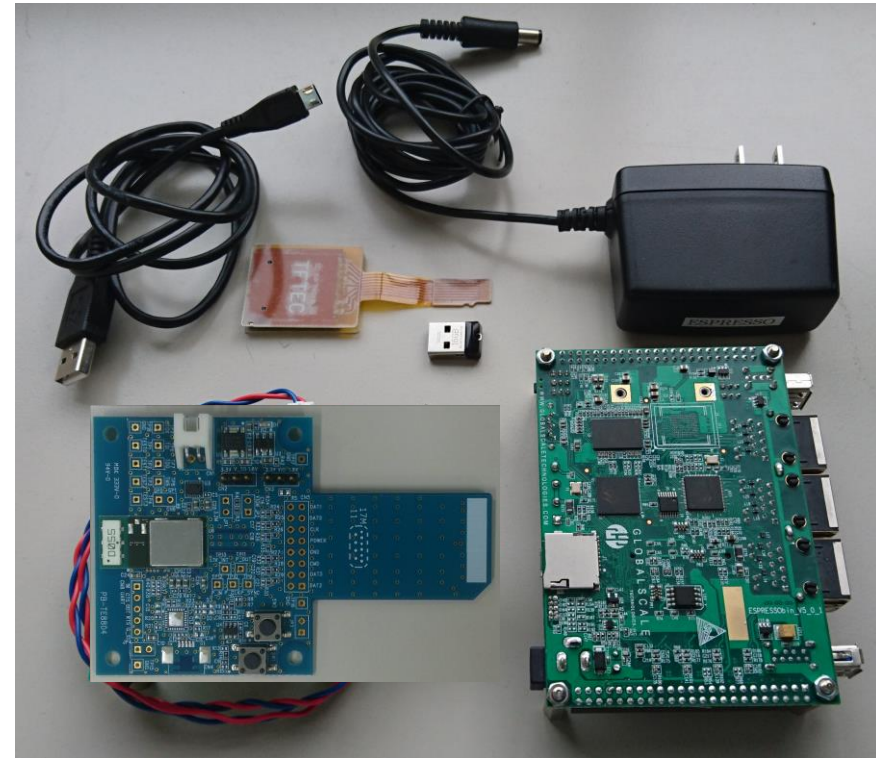

TAIYO YUDEN

X-ON Electronics

Largest Supplier of Electrical and Electronic Components

Click to view similar products for [Multiprotocol Development Tools](#) category:

Click to view products by [Taiyo Yuden](#) manufacturer:

Other Similar products are found below :

[CYW94343WWCD1_EVB](#) [MIKROE-2439](#) [XKC-M5T-W](#) [ATWINC3400-XPRO](#) [DEMOBOARD-T7024PGM](#) [2636](#) [Gpy](#) [STEVAL-FKI001V1](#) [8265.NGWMG.DTX1](#) [TEL0111](#) [SiPy 22 dBm](#) [ATWINC3400-XSTK](#) [RE-WFKIT-9260NVP](#) [2542](#) [irpi01-868](#) [irpi01-915](#)
[BCM94343WWCD1_EVB](#) [INP3010](#) [INP3011](#) [ISM43340-L77-EVB](#) [ISMART43362-E](#) [ISP4520-AS-DK](#) [nRF9160-DK](#) [QPQ1906EVB-01](#)
[102010129](#) [102991023](#) [107990093](#) [113990254](#) [SIMSA868C-Cloud-DKL](#) [SIMSA868-Cloud-DKL](#) [SIMSA915-Cloud-DKL](#) [SIMSA-DKL](#)
[SKY66423-11EK2](#) [SKY66423-11EK1](#) [80-000535](#) [DFR0505](#) [XKC-V1T-U](#) [FiPy](#) [453-00010-K1](#) [453-00011-K1](#) [DVK-BTM431](#) [DVK-](#)
[RM186-SM-01](#) [XPC270300EK](#) [MIKROE-2440](#) [MTDOT-BOX-G-868-B](#) [LBEH5DU1BW-TEMP-DS-SD](#) [113030023](#) [SKY66420-11EK1](#)
[SKY66420-11EK2](#) [SKY66420-11EK3](#)