



TAOGLAS®



Datasheet

MagmaX2

Part No:
AA.200.151111

Description:

MagmaX2 Multiband Active GNSS Magnetic Mount Antenna
With 1.5m RG-174 Cable and SMA(M) Connector

Features:

Magnetic mount with robust IPXX Rated Enclosure

Covering Bands:

- GPS/QZSS (L1/L2)
- GPS/QZSS/IRNSS (L5)
- Galileo (E1/E5a/E5b)
- GLONASS (G1/G2/G3)
- BeiDou (B1/B2a/B2b)

Low Axial Ratio

Cable: 1.5m RG-174 Cable

Connector: SMA Male Straight

CE Certified

RoHS & Reach Compliant



1.	Introduction	3
2.	Specifications	4
3.	Antenna Characteristics	7
4.	Active Antenna Characteristics	14
5.	Radiation Patterns	20
6.	Field Test Results	26
7.	Mechanical Drawing	28
8.	Packaging	29
<hr/>		
	Changelog	30

Taoglas makes no warranties based on the accuracy or completeness of the contents of this document and reserves the right to make changes to specifications and product descriptions at any time without notice. Taoglas reserves all rights to this information contained herein. Reproduction, use or disclosure to third parties without express permission is strictly prohibited.



1. Introduction



The Taoglas MagmaX2 AA.200 is an active GNSS magnetic mount antenna for use across most major constellations including GPS (L1/L2/L5), GLONASS (G1/G2/G5), Galileo(E1/E5a/E5b) and BeiDou(B1/B2). The antenna exhibits excellent gain and good radiation pattern stability leading to a reliable GPS fix in areas of weaker signal strength. These elements combine to ensure the best possible positional accuracy in both RTK and non-RTK systems.

Typical applications include:

- UAVs and Robotics
- Autonomous Vehicles
- High Accuracy Positioning
- RTK Systems
- Precision Agriculture
- Navigation

The AA.200 provides excellent positional accuracy, this is due to outstanding signal to noise ratio(C/N0) and a low axial ratio of less than 2 thus ensuring the antenna maintains stable when a location is required. With great 2DRMS and Fast time to first fix the AA.200 is the ideal antenna solution for Multiband GNSS RTK Systems as it performs very well, with stable gains and low axial ratio values across all major GNSS bands.

The AA.200 includes LNAs and front-end SAW filters to reduce out of band noise, such as from nearby cellular transceivers. It offers better protection from nearby radiated power surges and greatly reduces the probability of damaging your GNSS receiver from nearby transmissions. The AA.200 has 1 cable feed as the L1, L2 and L5 feeds are combined with a hybrid coupler and the antenna performance results are shown in the below sections.

The cable and connector are fully customizable, subject to NRE and MOQ. For further information please contact your regional Taoglas customer support team.

2. Specifications

GNSS Frequency Bands Covered						
GPS	L1	L2	L5			
	■	■	■			
GLONASS	G1	G2	G3			
	■	■	■			
Galileo	E1	E5a	E5b	E6		
	■	■	■	□		
BeiDou	B1	B2a	B2b	B3		
	■	■	■	■		
QZSS (Regional)	L1	L2C	L5	L6		
	■	■	■	□		
IRNSS (Regional)	L5					
	■					
SBAS	L1/E1/B1	L5/B2a/E5a	G1	G2	G3	
	■	■	■	■	■	

*SBAS systems: WASS(L1/L5), EGNOS(E1/E5a), SDCM(G1/G2/G3), SNAS(B1,B2a), GAGAN(L1/L5), QZSS(L1/L5), KAZZ(L1/L5).

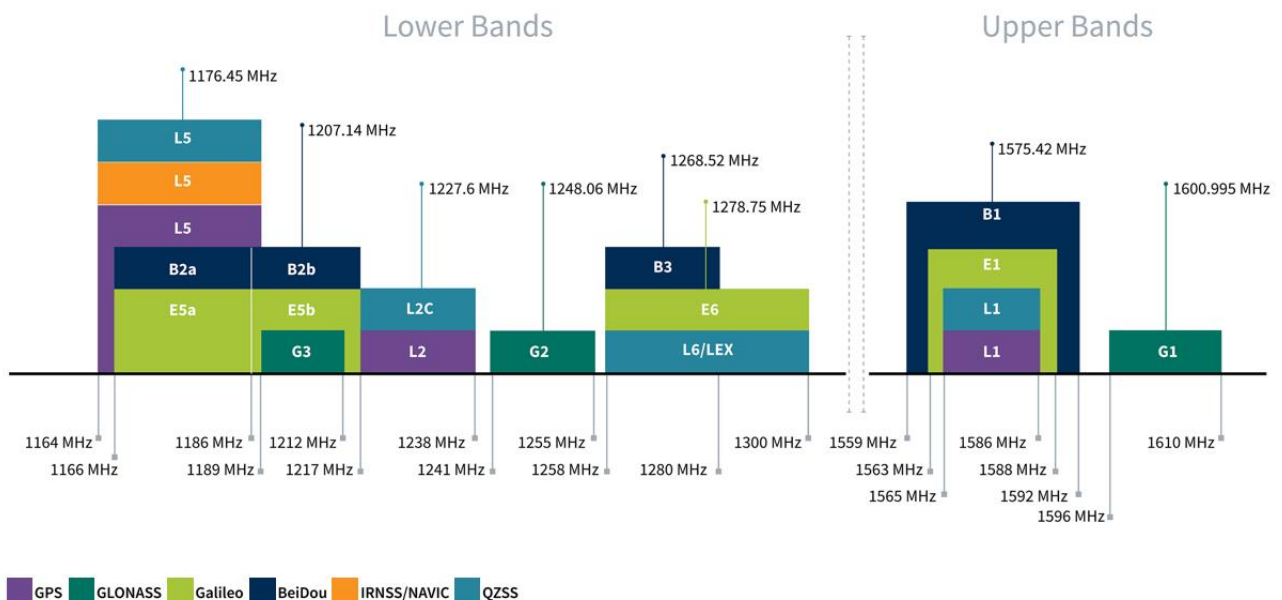

GNSS Bands and Constellations

GNSS Electrical					
Frequency (MHz)	1176.45	1227.6	1561	1575.42	1602
VSWR (max.)	2.0:1	2.0:1	2.0:1	2.0:1	2.0:1
Passive Antenna Efficiency (%) (Without cable loss)	51.5	33.3	51.0	60.4	51.6
Passive Antenna Gain at Zenith (dBi) (Without cable loss)	0.6	-0.9	2.1	2.9	2.4
Axial Ratio(dB)	1.8	1.2	1.1	1.1	1.1
Group Delay	5	10	5	5	5
PCO (cm)	1.7	0.9	1.4	1.2	1.2
PCV (cm)	2.3	2.2	0.51	0.51	0.51
Polarization	RHCP				
Impedance	50Ω				
Cable	RG-174, 1.5m				
Connector	SMA(M) Straight				

LNA and Filter Electrical Properties					
Frequency (MHz)	1176.45	1227.6	1561	1575.42	1602
VSWR (max.)	2.0:1	2.0:1	2.0:1	2.0:1	2.0:1
Gain@1.8V (dB)	25.17	27.81	27.48	27.76	26.79
Gain@3.0V (dB)	25.15	27.8	27.48	27.8	26.79
Gain@5.5V (dB)	25.2	27.83	27.48	27.8	26.8
Noise@1.8V (dB)	4.96	2.94	2.30	2.13	2.40
Noise@3.0V (dB)	4.95	2.94	2.33	2.15	2.44
Noise@5.5V (dB)	4.98	2.94	2.36	2.13	2.43
Power consumption@1.8V (mA)	17.86				
Power consumption@3.0V (mA)	17.91				
Power consumption@5.5V (Typ.)	17.93				

Total Specification (Through Antenna, SAW Filter and LNA)					
Frequency (MHz)	1176.45	1227.6	1561	1575.42	1602
Gain@3V (dBi)	24.8 dBi	26.2 dBi	26.1 dBi	26.1 dBi	26.1 dBi
Output Impedance	50 Ω				

Mechanical

Housing Dimensions	63.2*67.2*26.5 mm
Housing Material	ABS
Cable	1.5m of RG-174
Connector	SMA(M)
Weight	160g
Magnetic Pull Force	Average vertical pull force(kgf): 2.5

Environmental

Temperature Range	-40°C to 85°C
Humidity	Non-condensing 65°C 95% RH
Protection	IP67
RoHS Compliant	Yes
REACH Compliant	Yes

3. Antenna Characteristics

3.1 Return Loss (dB)

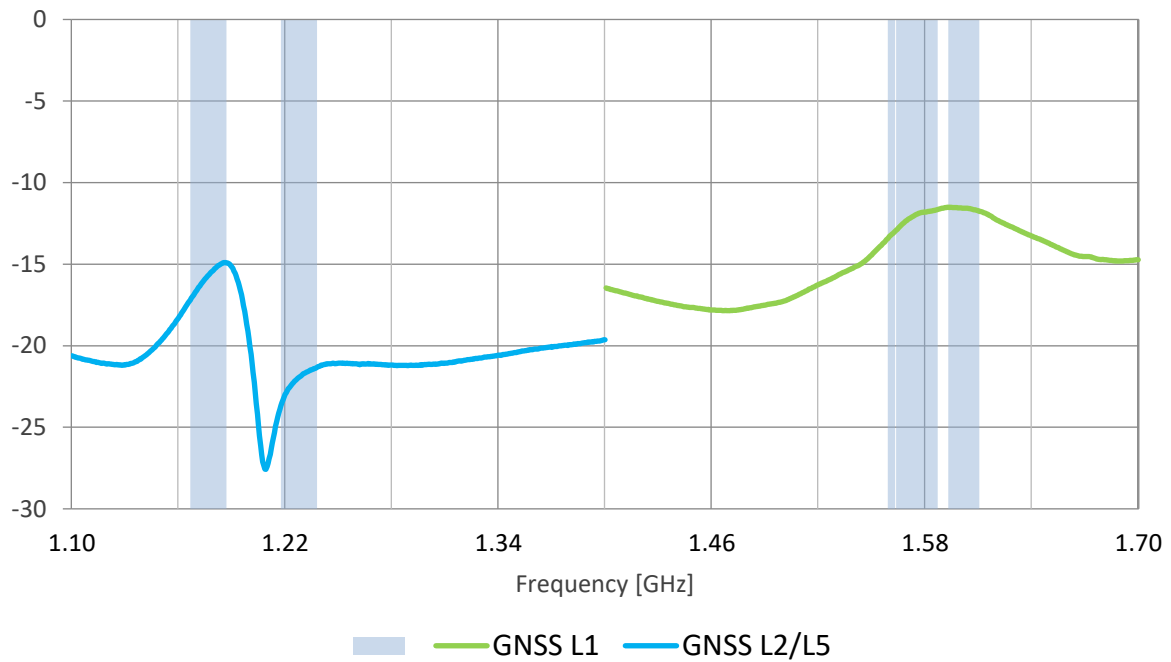

3.2 VSWR

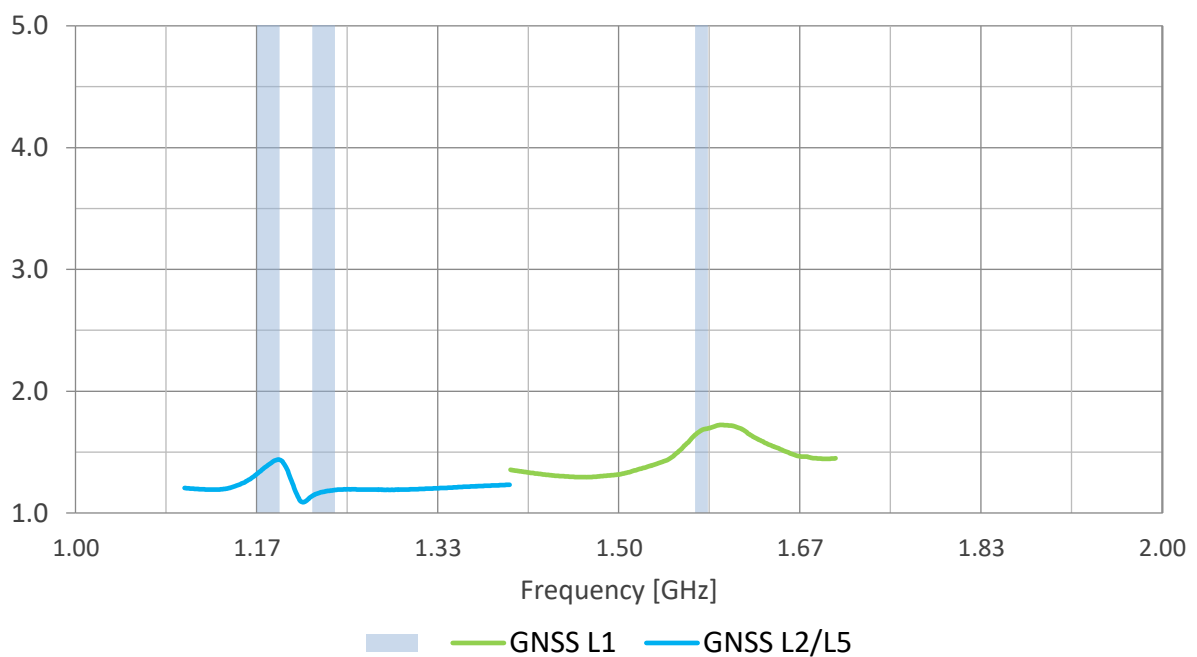

3.3 Efficiency (%)

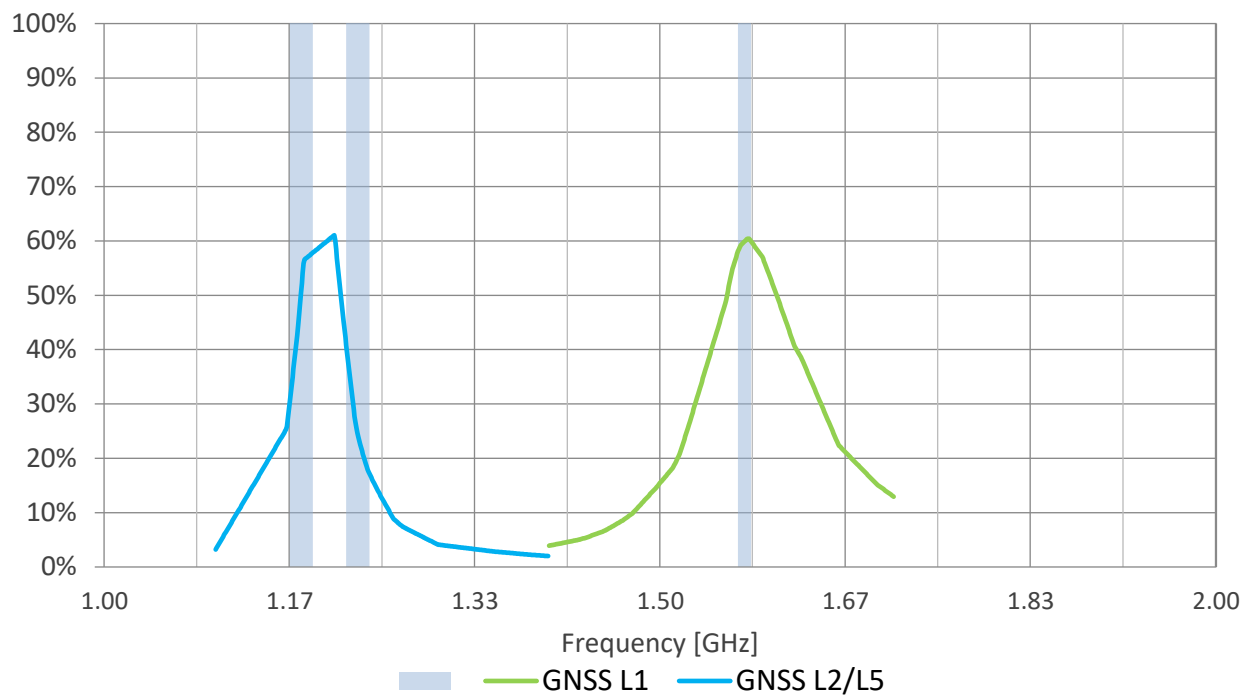

3.4 Average Gain (dB)

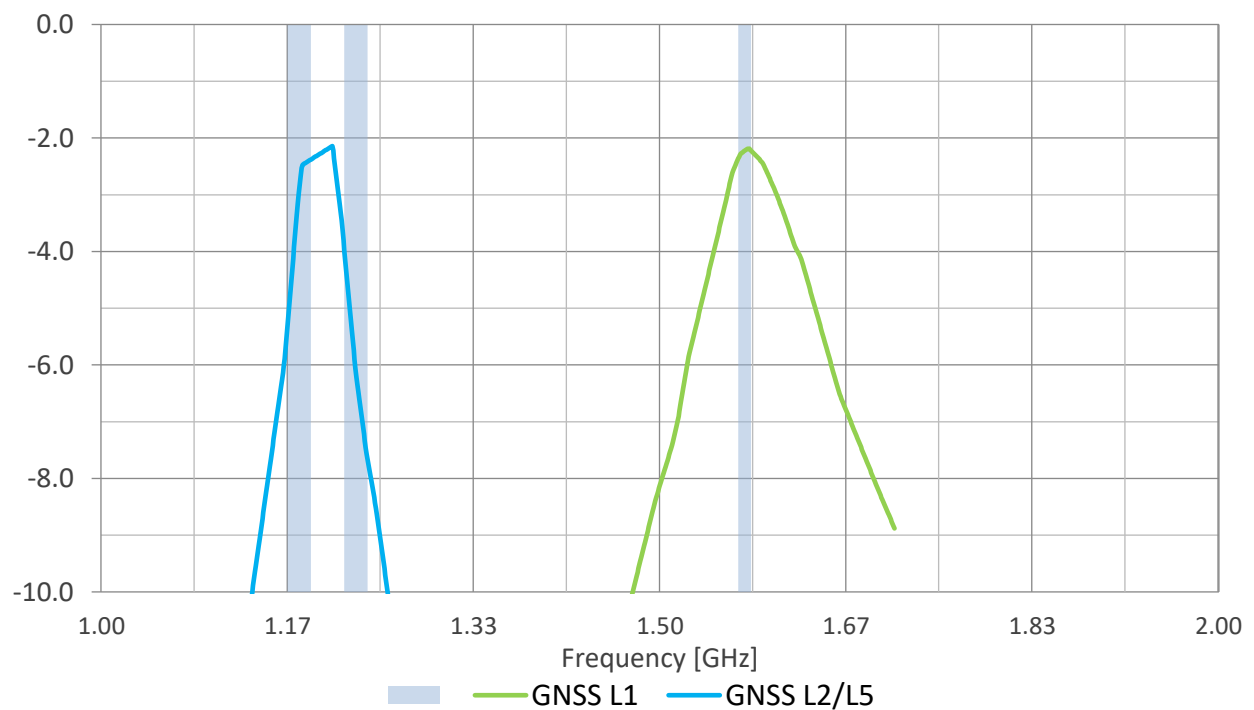

3.5 Peak Gain (dBi)

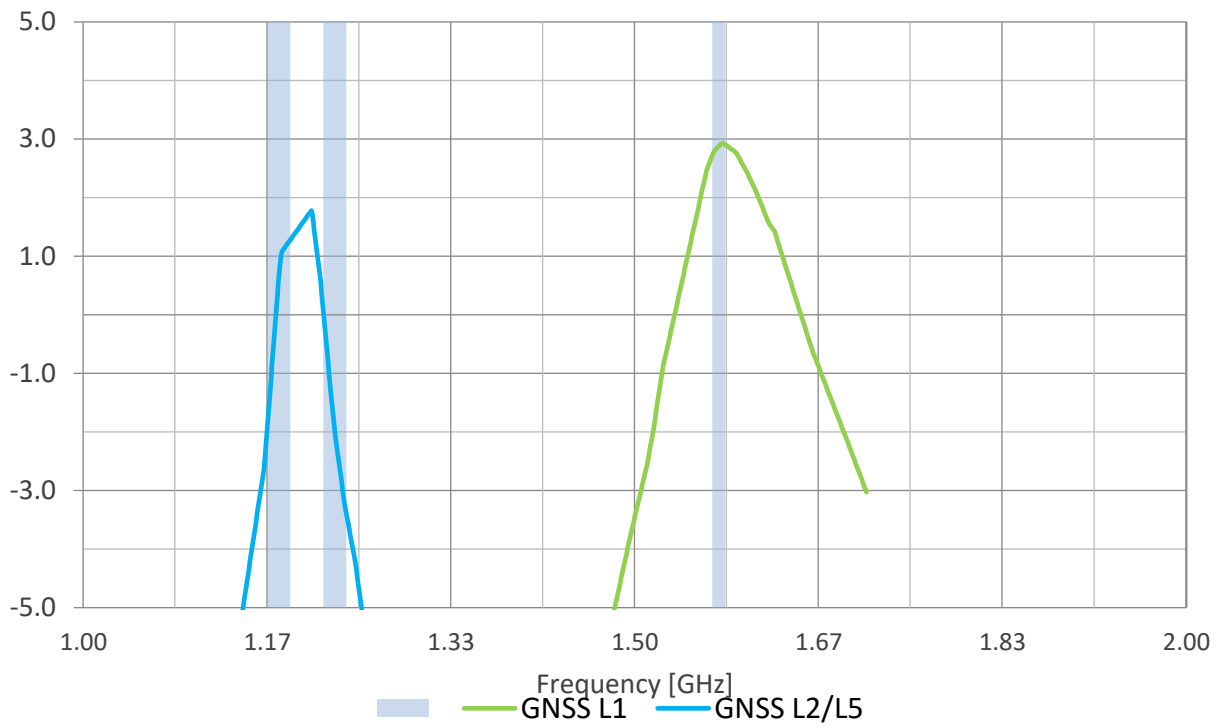

3.6 Axial Ratio – Free Space

L1

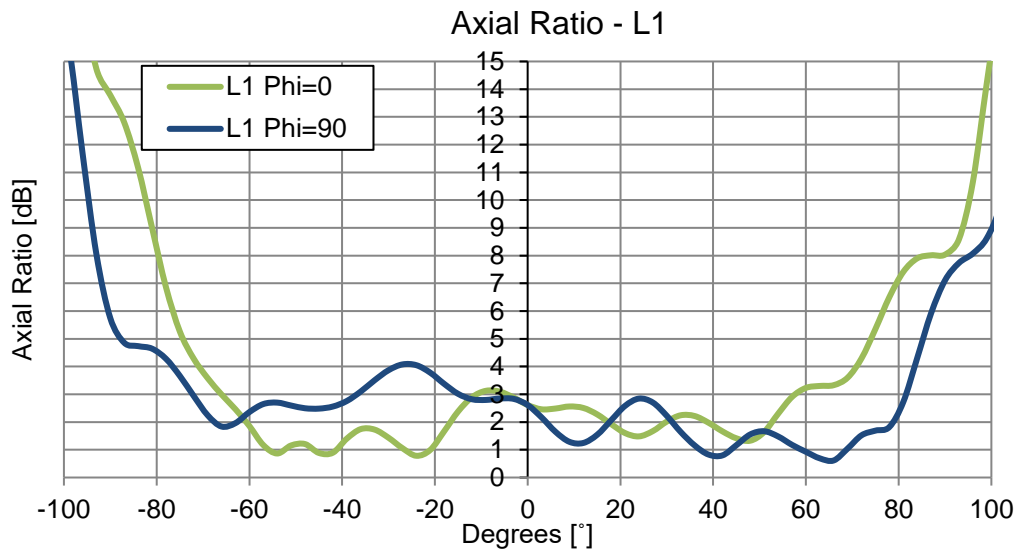

L2

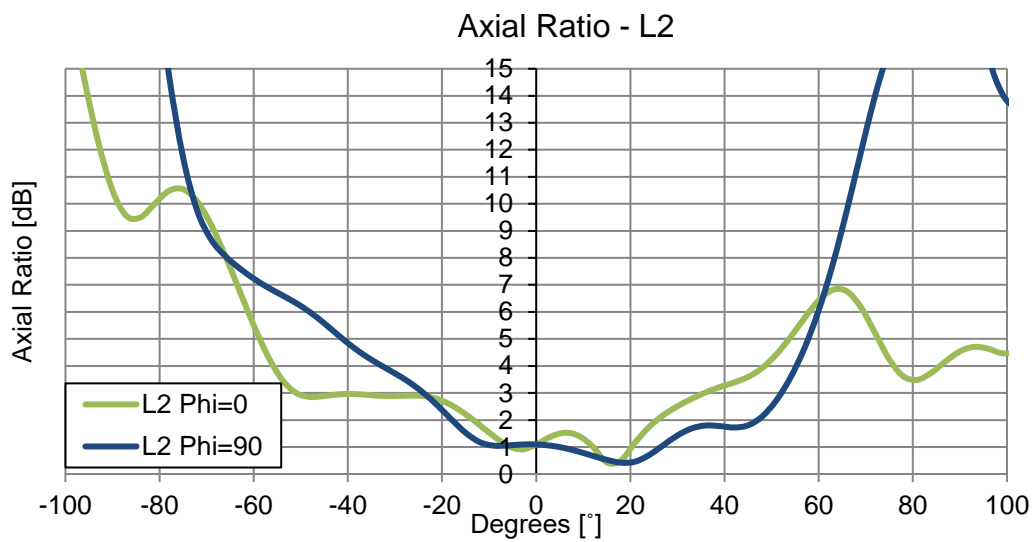

L5

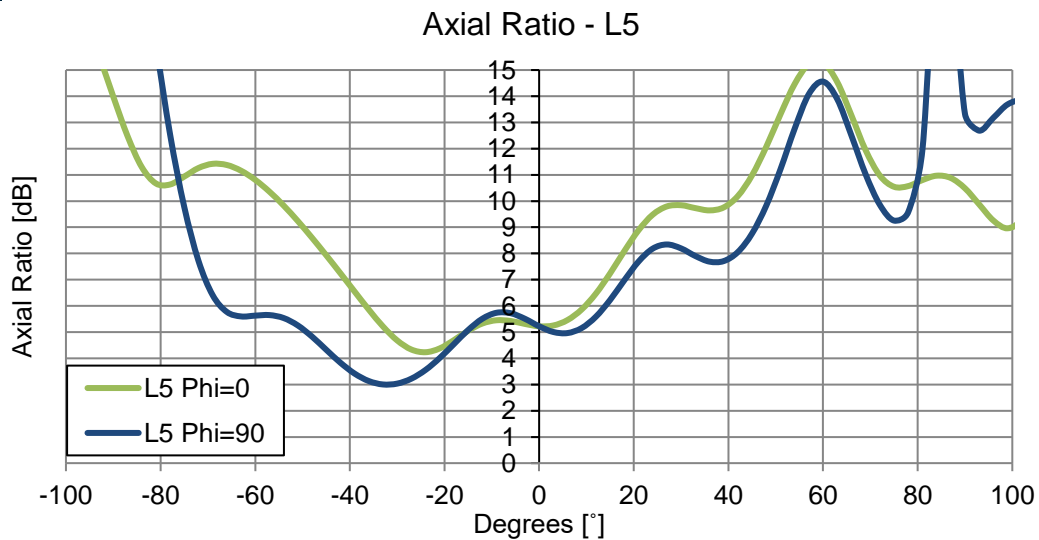

3.7 Axial Ratio – 30*30cm Ground Plane

L1

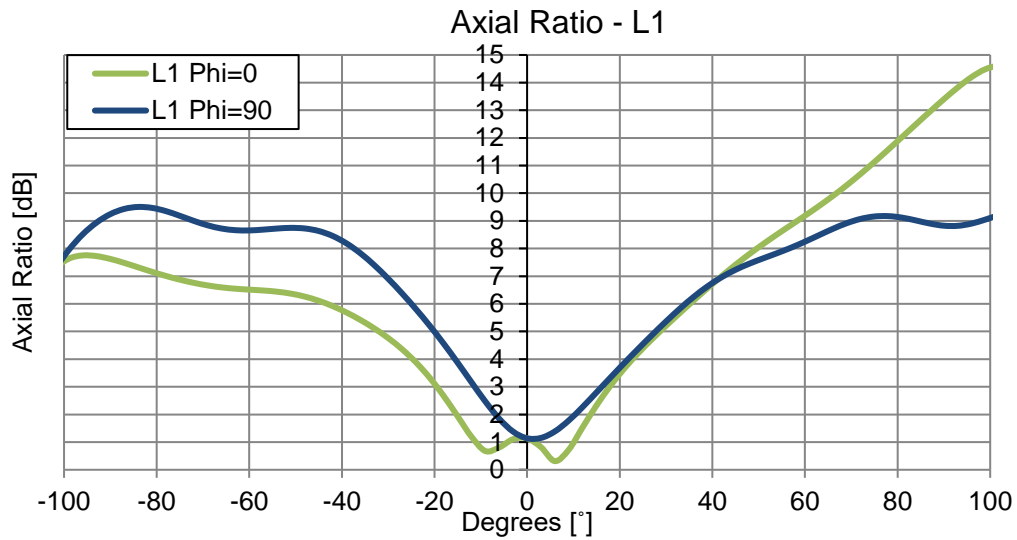

L2

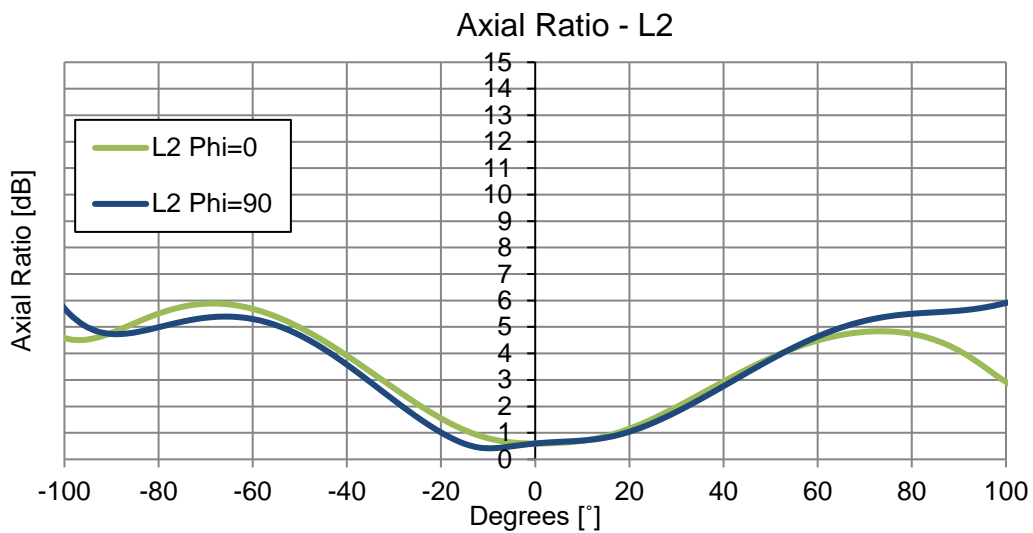

L5

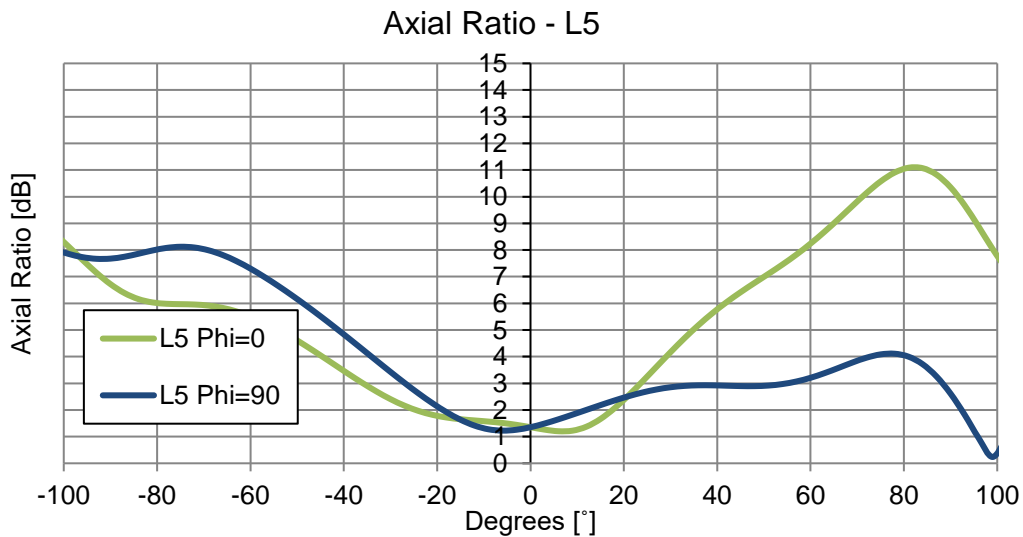

3.8 Axial Ratio vs Frequency – Free Space

L1

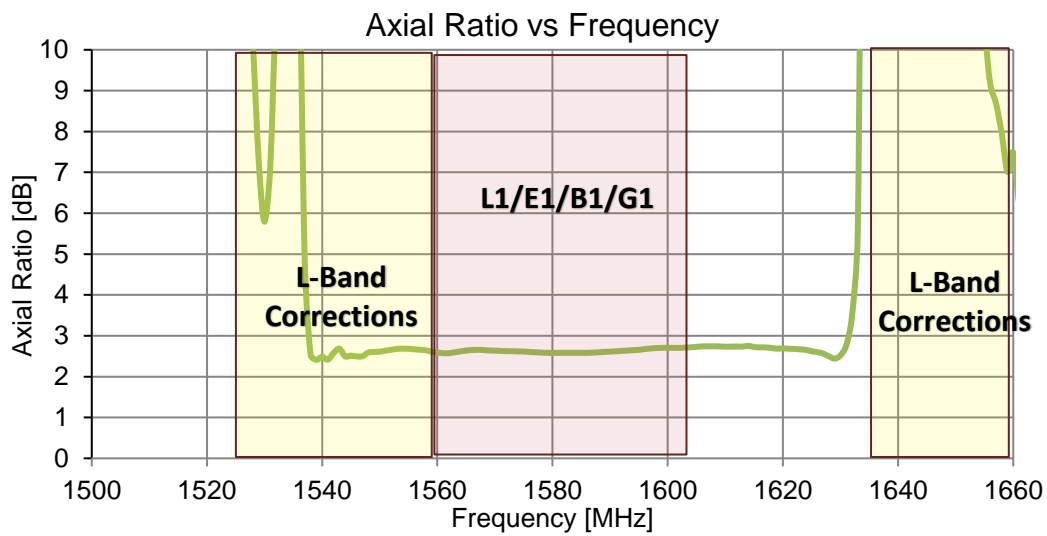

L2

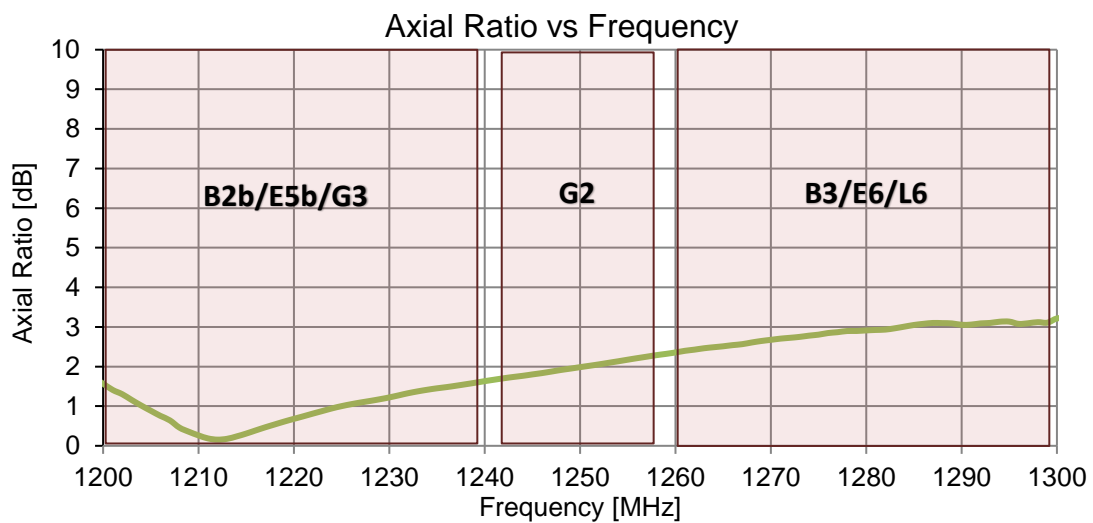

L5

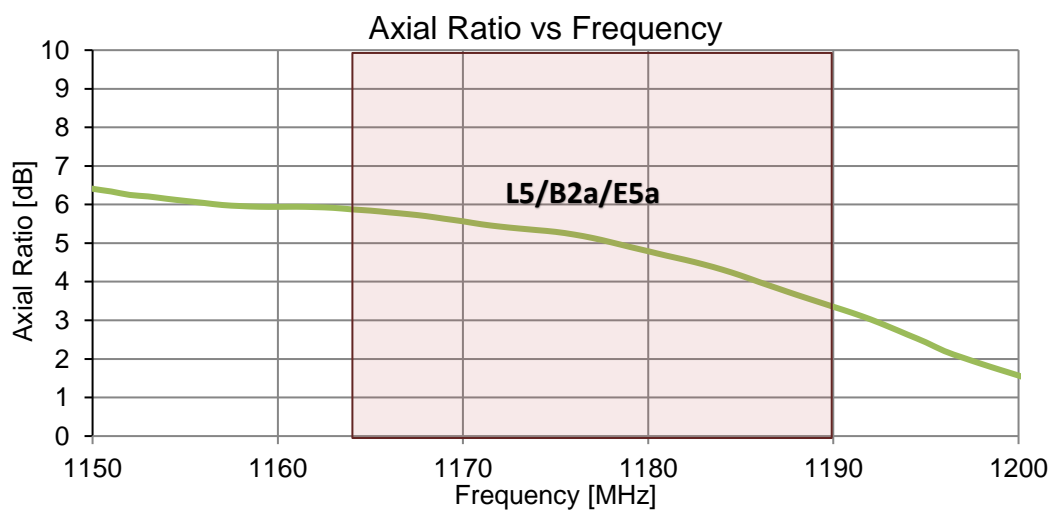

3.9 Axial Ratio vs Frequency – 30*30cm Ground Plane

L1

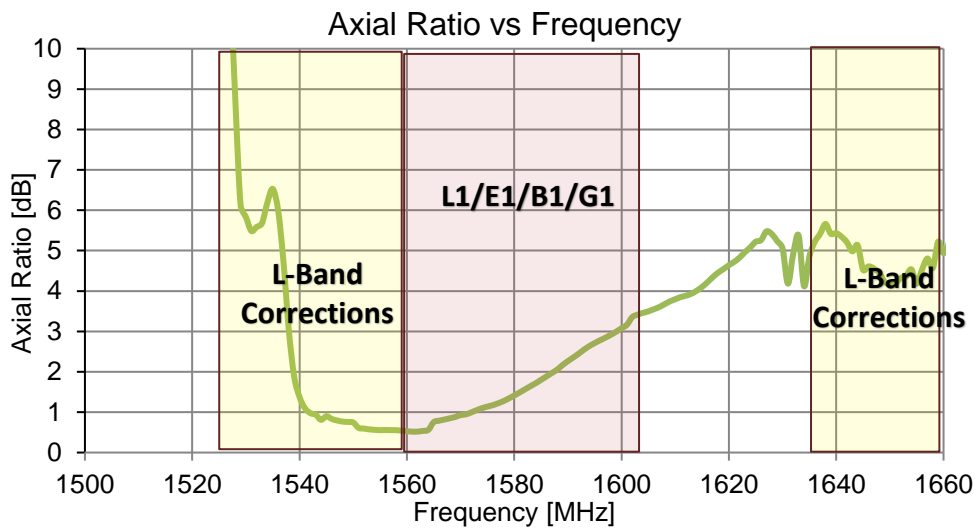

L2

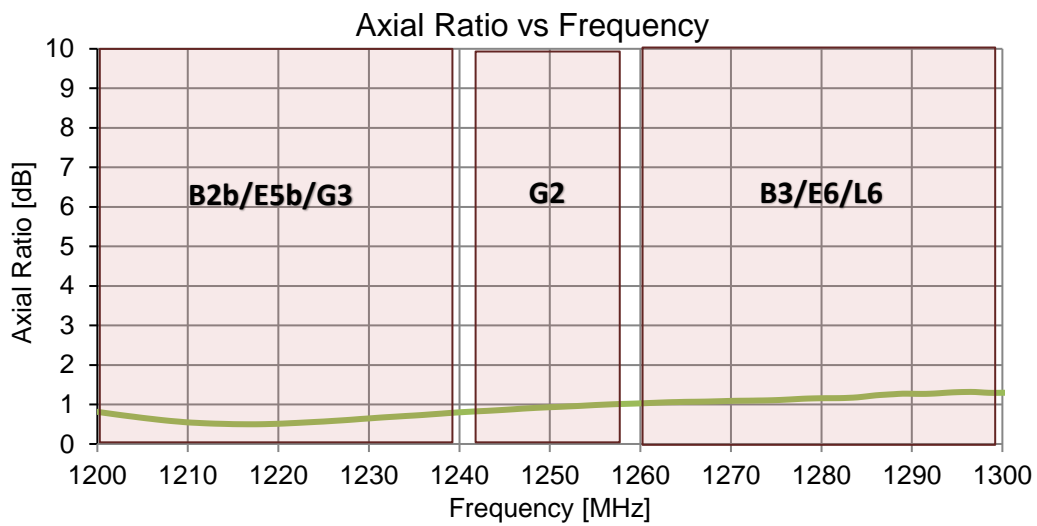

L5

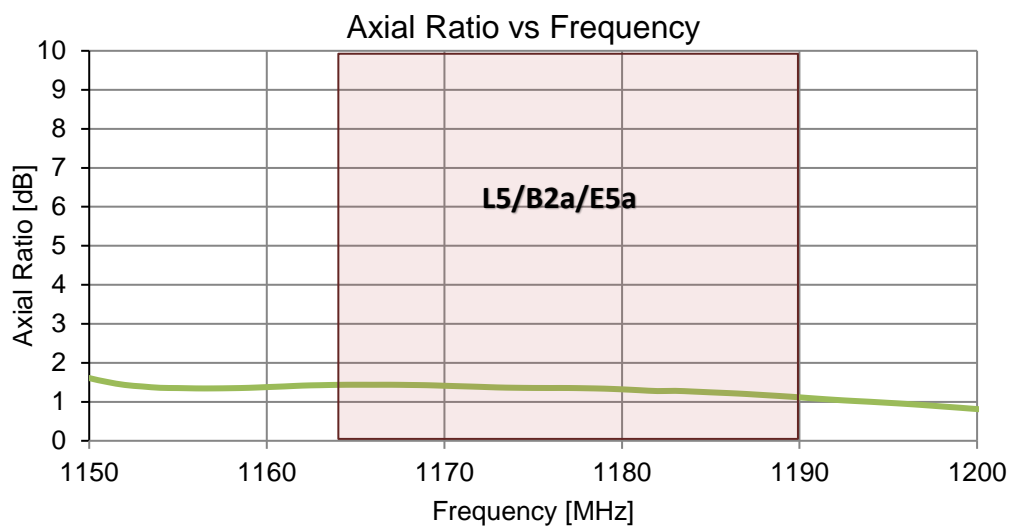

4. Active Antenna Characteristics

4.1 LNA Block Diagram

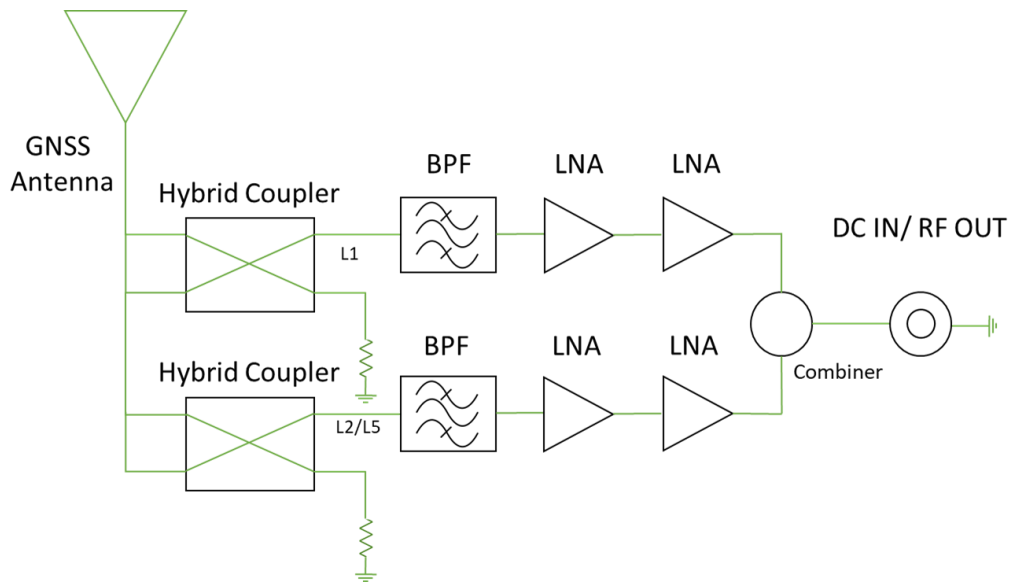

4.2 LNA Gain L2 & L5 @3V

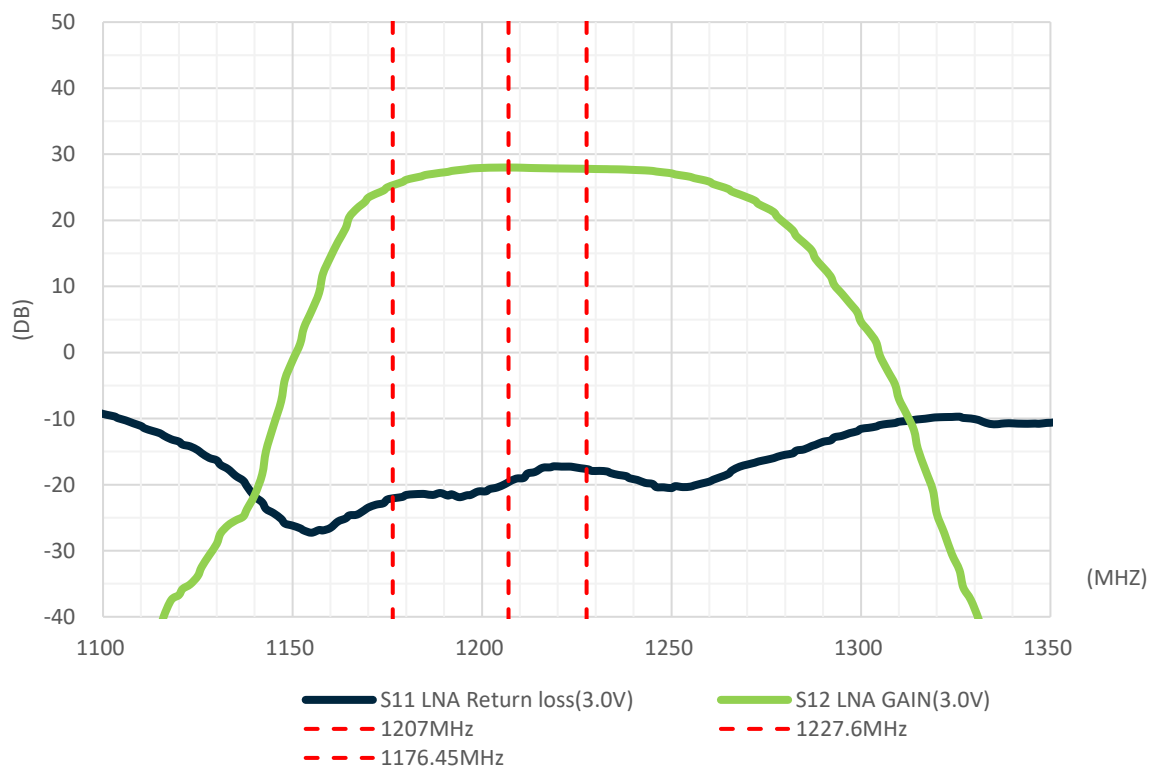

4.3 LNA Gain L1 Band @3V

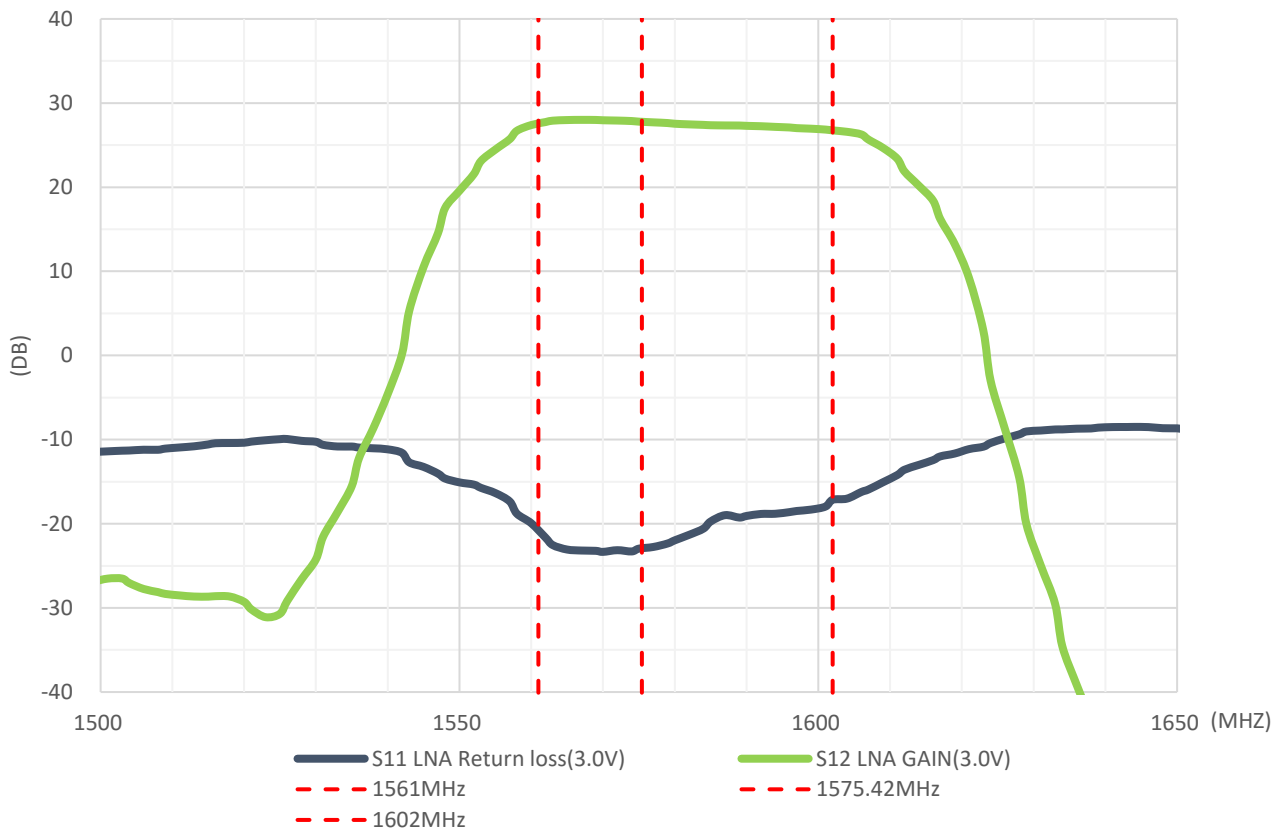

4.4 LNA Noise Figure @3V

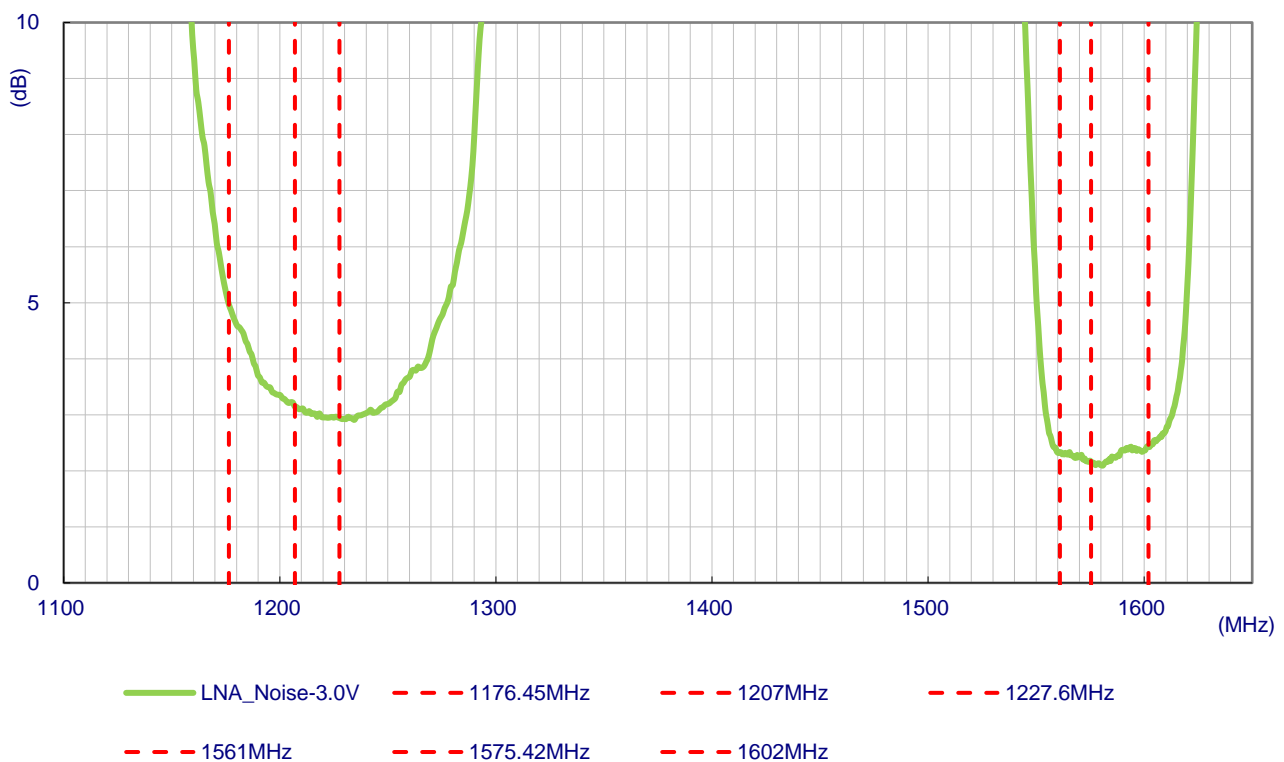

4.5 S12 Wide Band Plot

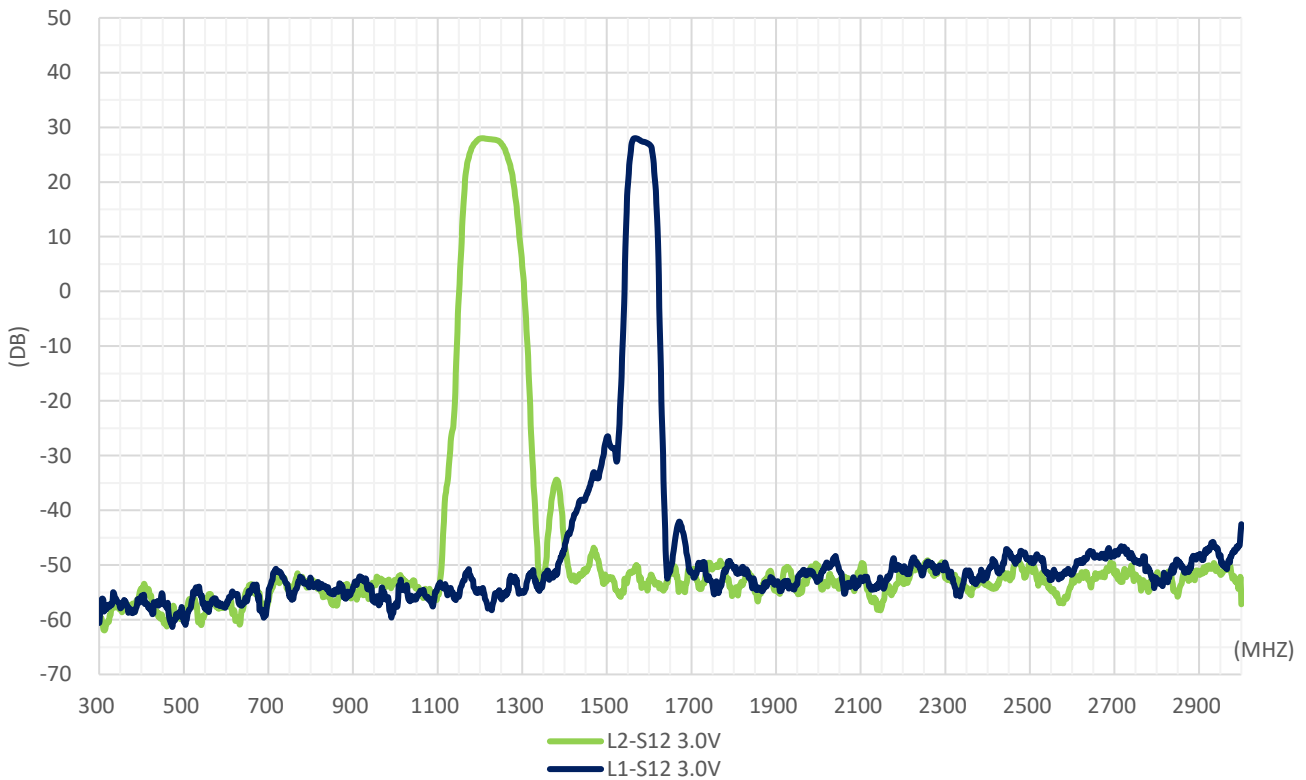

4.6 Combined Gain – 30*30cm Ground Plane

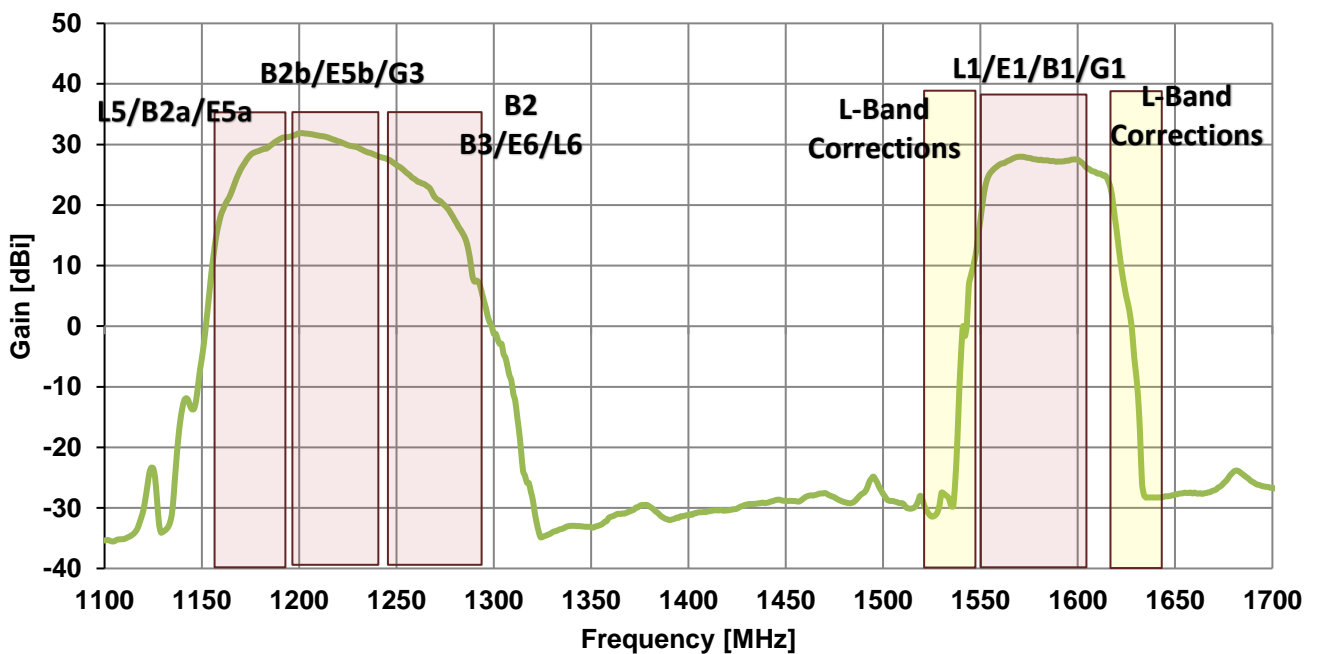

4.7 Combined Gain – Free Space

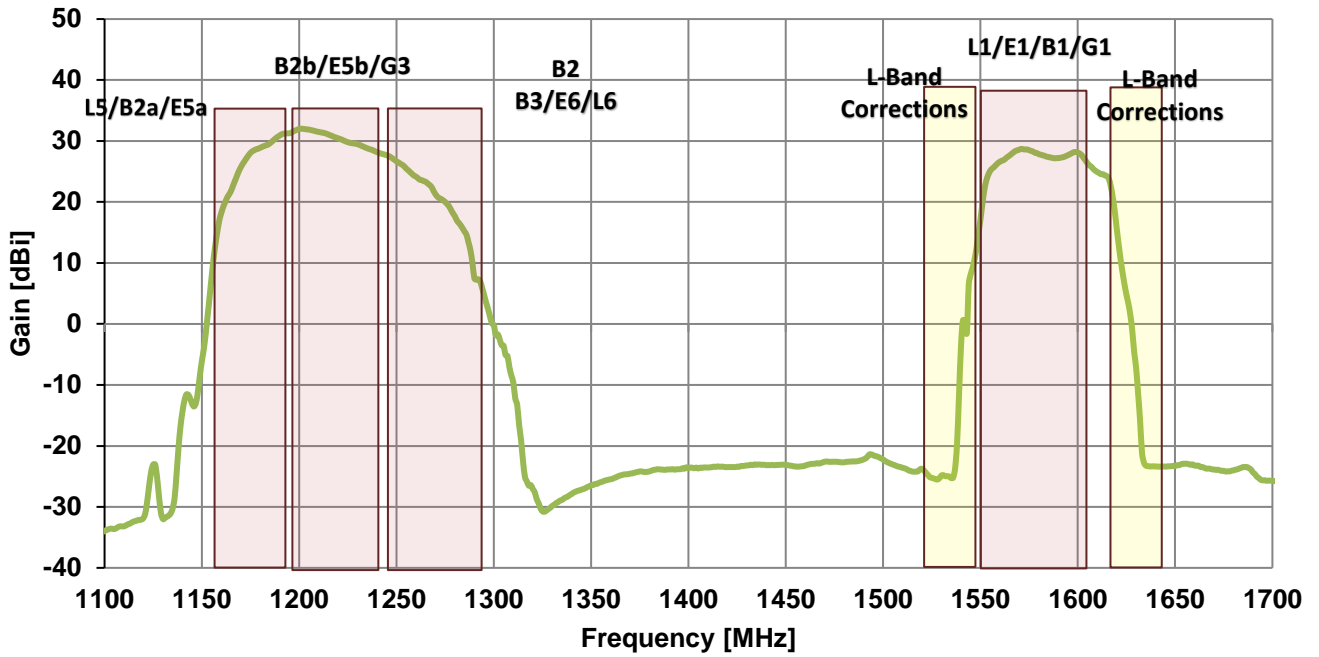

4.8 Group Delay vs Frequency – Free Space

L1

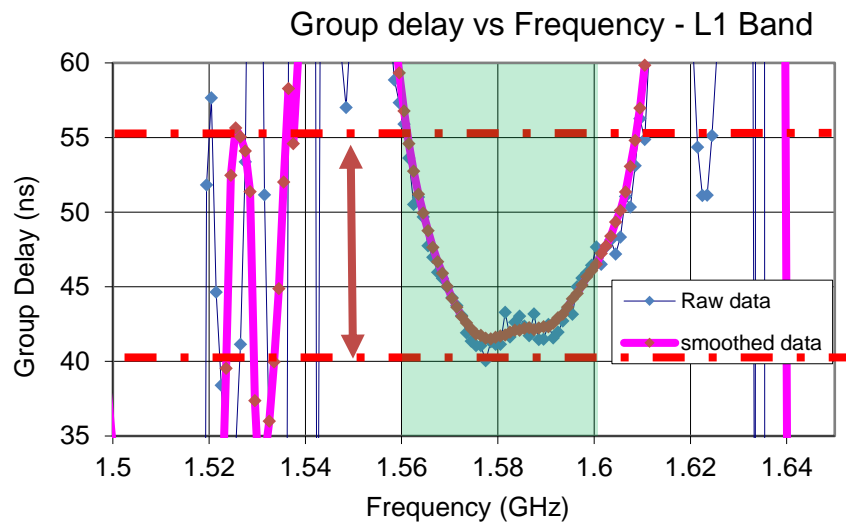

L2

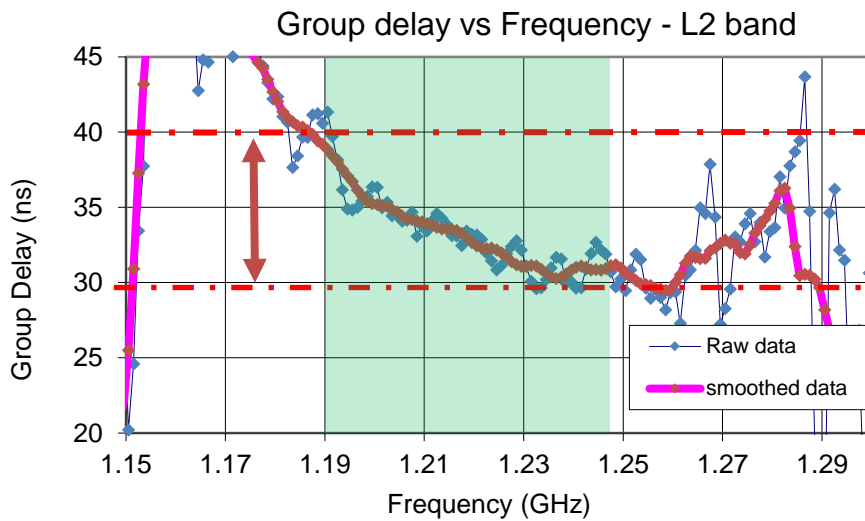

L5

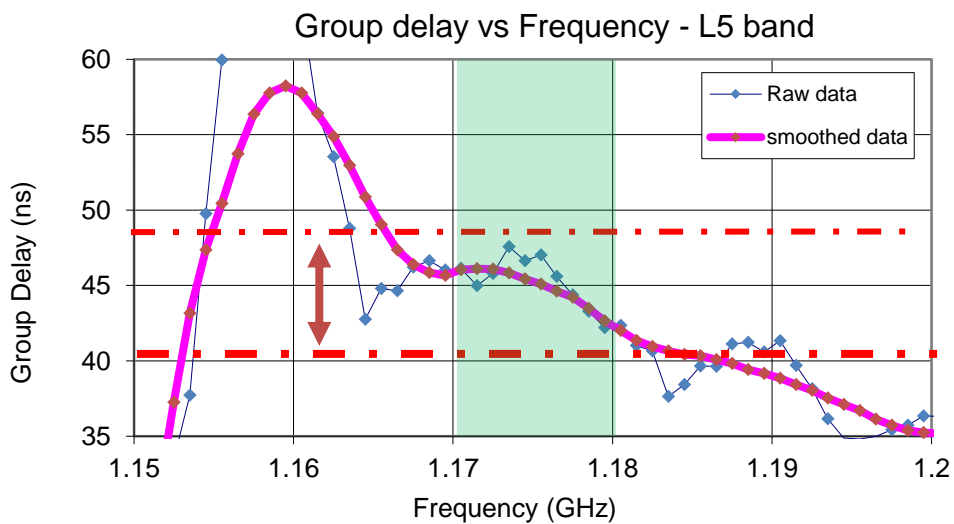

4.9 Group Delay vs Frequency – 30*30cm Ground Plane

L1

Group delay vs Frequency - L1 Band

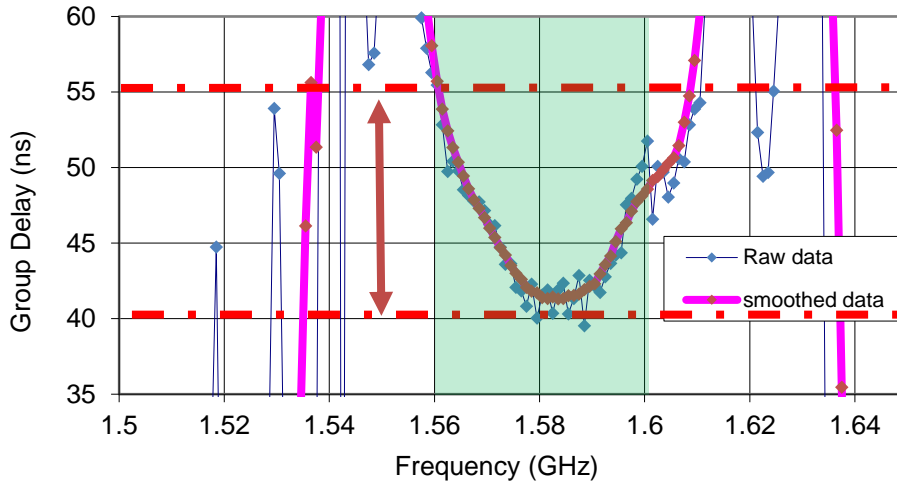

L2

Group delay vs Frequency - L2 band

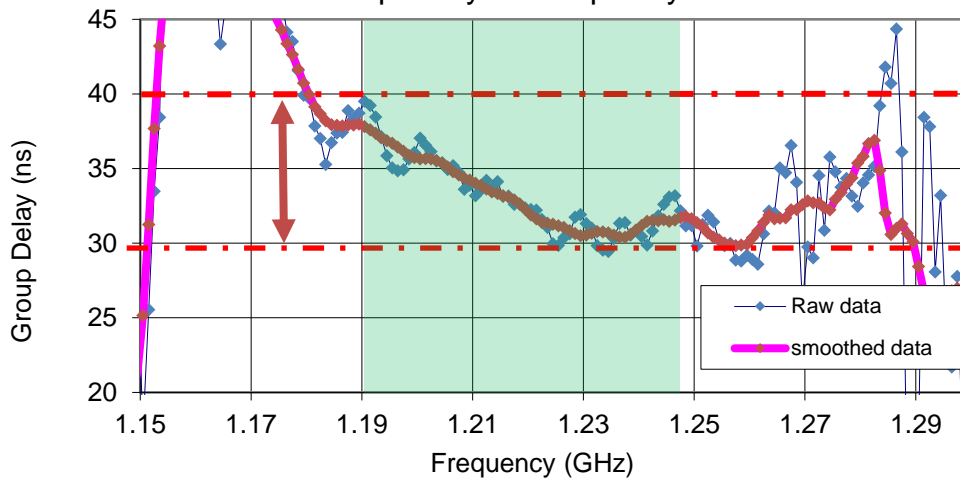

L5

Group delay vs Frequency - L5 band

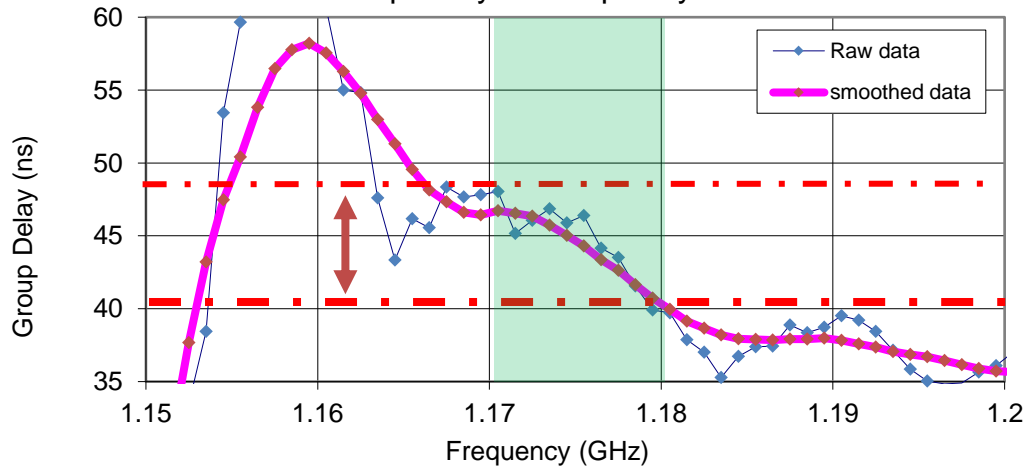

5. Radiation Patterns

5.1 Test Setup – Free Space

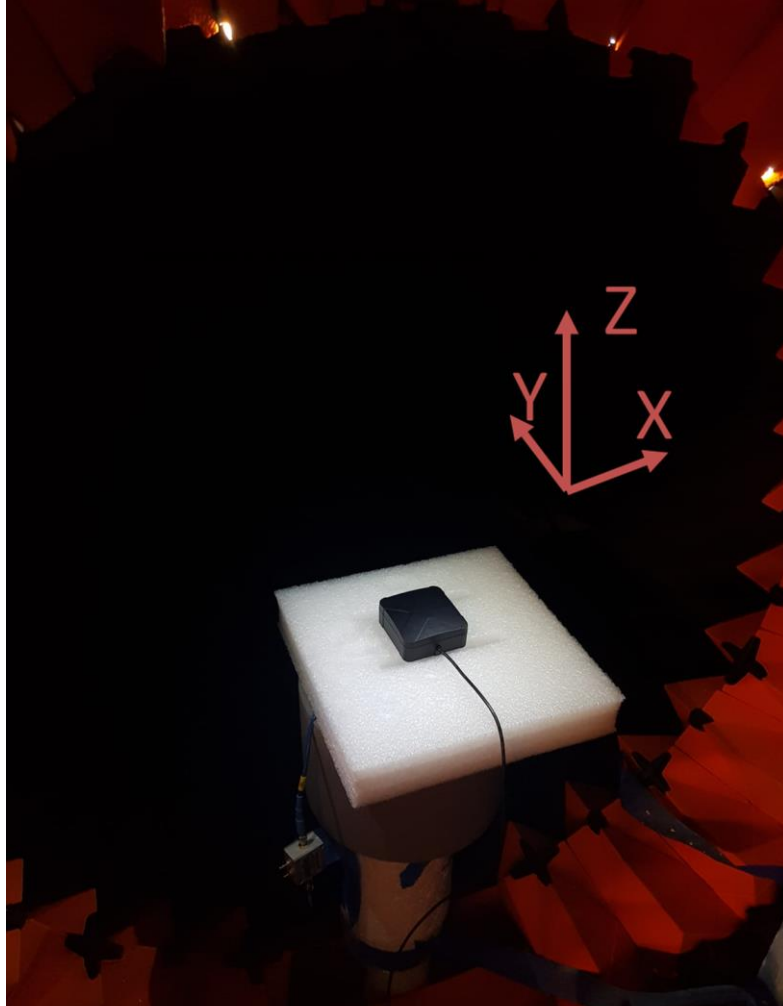

5.2 1176.45MHz 3D and 2D Radiation Patterns

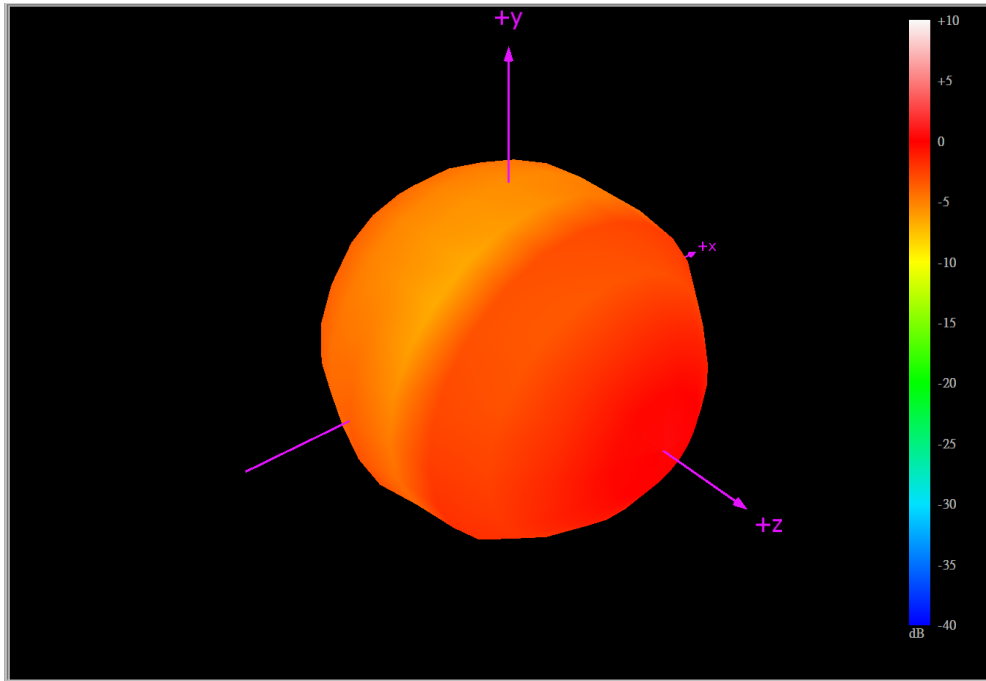

XY Plane

XZ Plane

YZ Plane

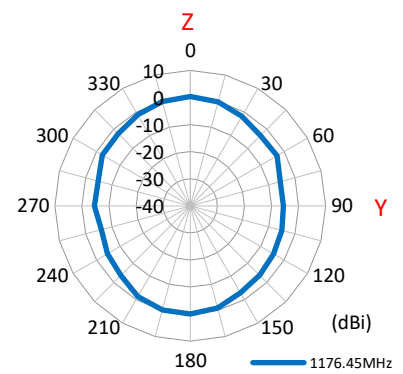
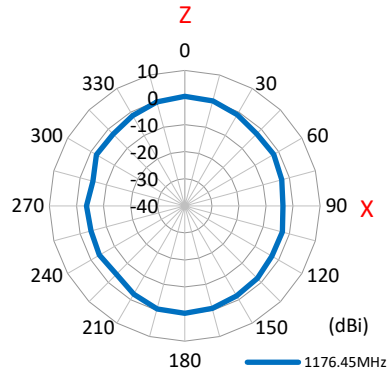
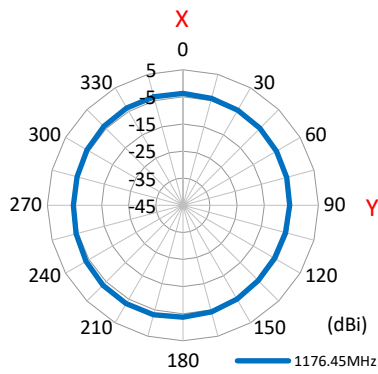

5.3 1227.6MHz 3D and 2D Radiation Patterns

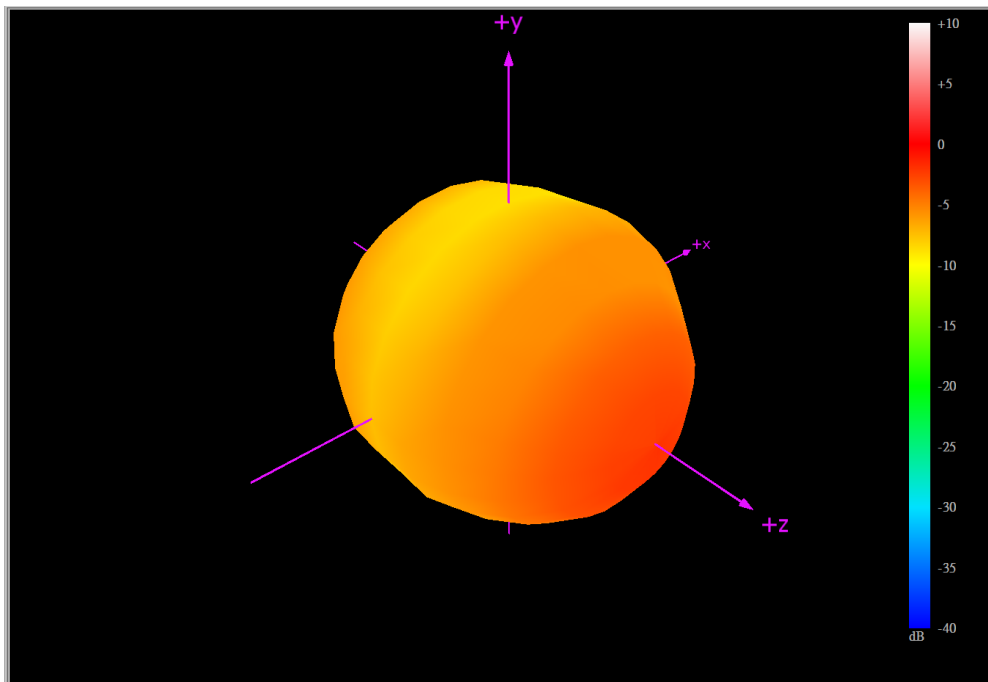

XY Plane

XZ Plane

YZ Plane

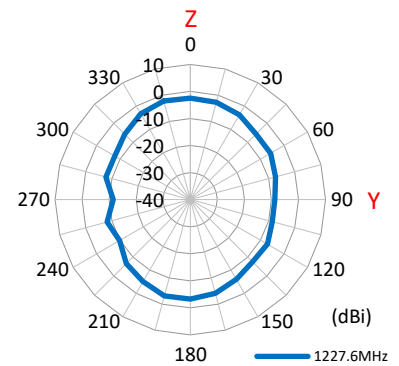
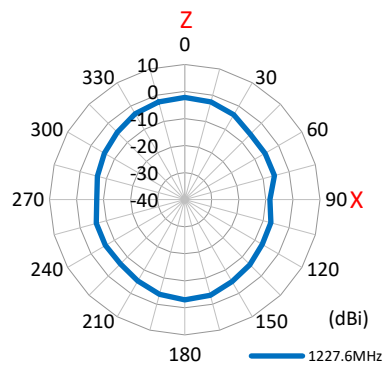
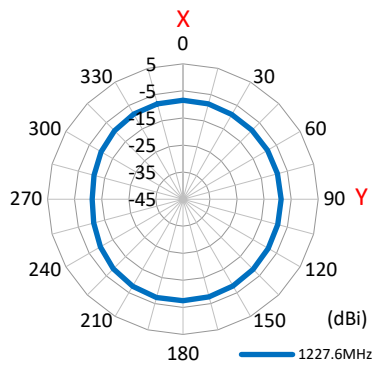

5.4 1561MHz 3D and 2D Radiation Patterns

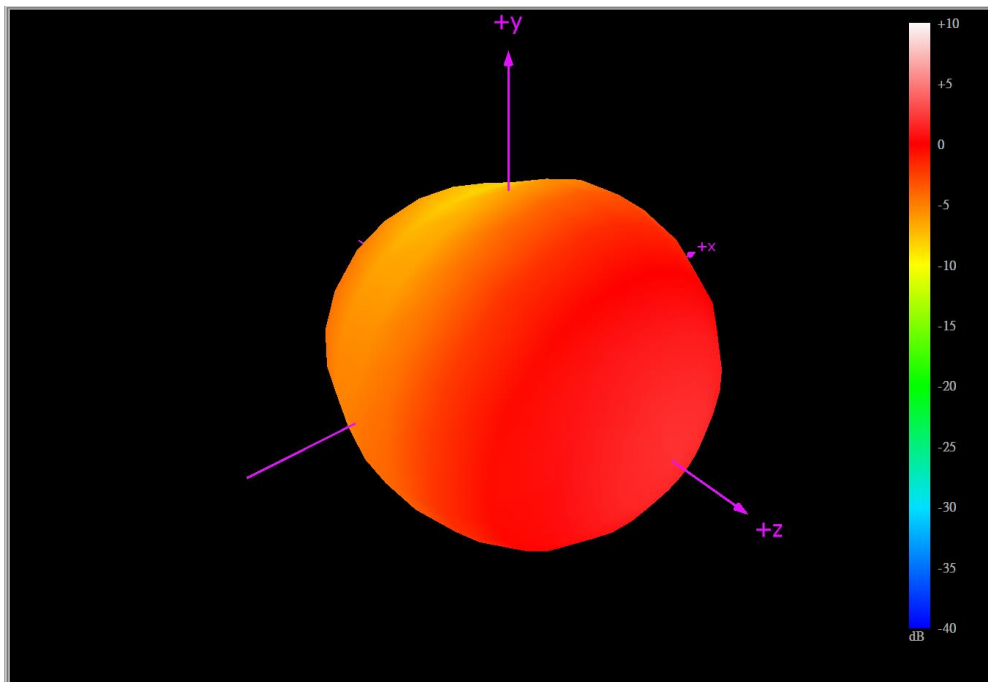

XY Plane XZ Plane YZ Plane

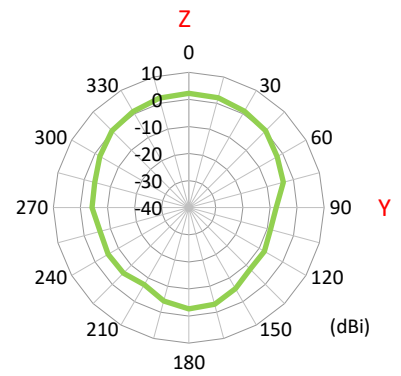
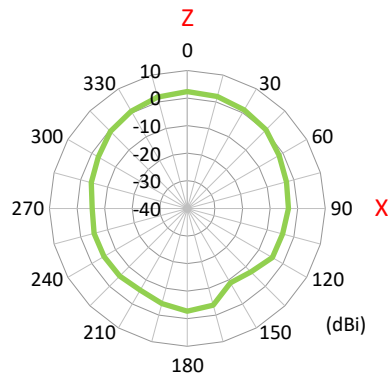
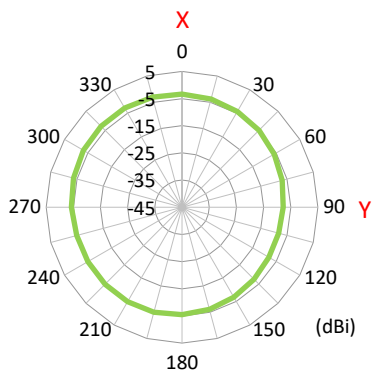

5.5 1575.42MHz 3D and 2D Radiation Patterns

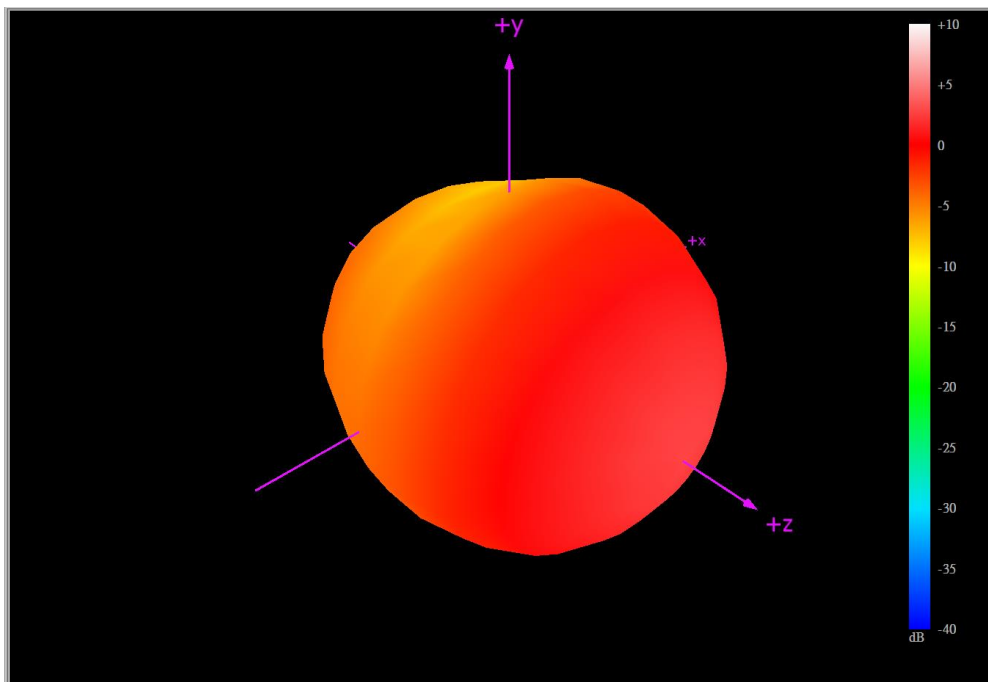

XY Plane XZ Plane YZ Plane

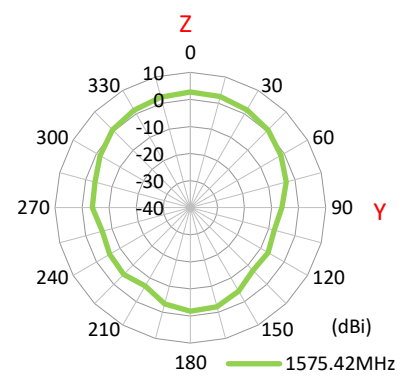
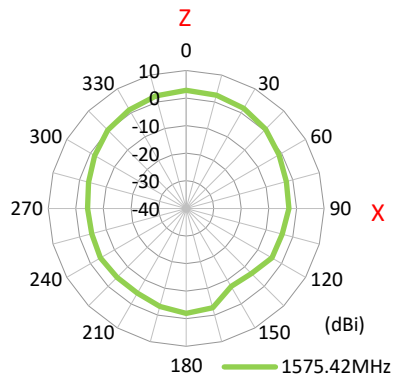
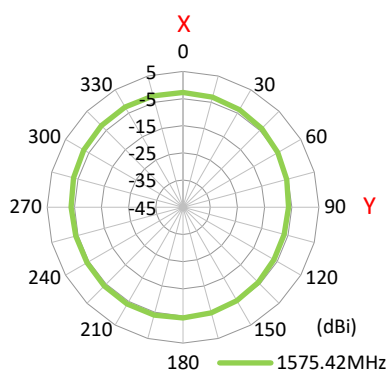

5.6 1602MHz 3D and 2D Radiation Patterns

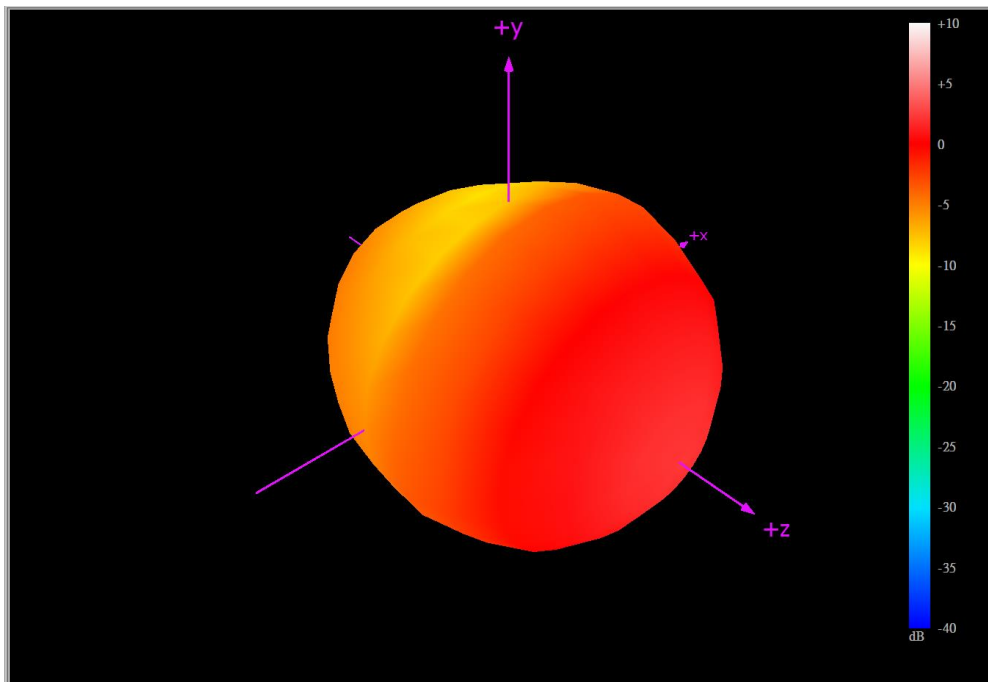

XY Plane

XZ Plane

YZ Plane

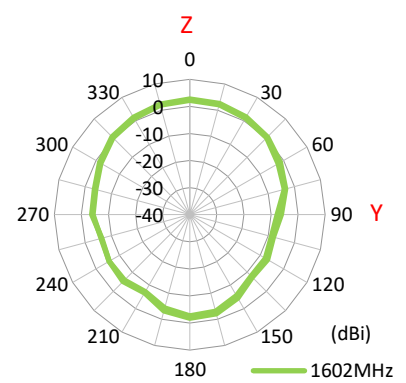
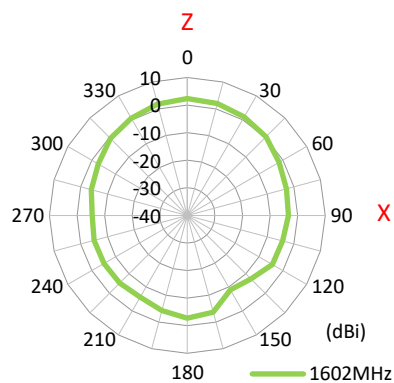
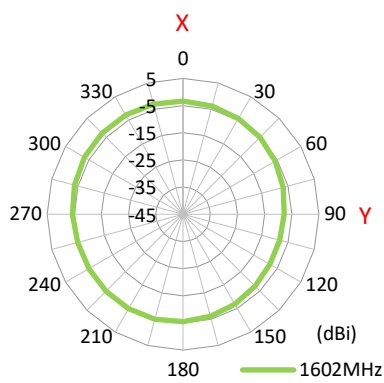

6. Field Test Results

6.1 Rooftop test

In this section Taoglas will present the field test result for AA.200 antenna. The test was performed when the antenna was mounted on a static rooftop test set up in an open sky environment for at least **6 hours**.

Taoglas will show the field test results using the following receiver:

1. Septentrio AsteRx-U S/N

- Multi-band GNSS: 544 channels
- GPS: L1, L2, L5 GLONASS: L1, L2, L3 Galileo: E1, E5ab, AltBoc, E6 BeiDou: B1, B2, B3 NavIC: L51 QZSS: L1, L2, L5, L6
- SBAS: EGNOS, WAAS, GAGAN, MSAS, SDCM(L1, L5)
- RTK (base and rover), Integrated dual-channel L-band receiver, Support for PPP
- Nav. update rate up to 100 Hz
- Position accuracy = RTK 0.6 cm + 0.5 ppm

Positioning Accuracy Table (2D Accuracy)					
Test Condition	Correction Service	CEP (50%)	DRMS (68%)	2DRMS (95-98.2%)	TTF (sec)
Free Space	RTK DISABLED	51.64 cm	61.89 cm	123.78 cm	22
	RTK ENABLED	1.37 cm	1.65 cm	3.29 cm	22
30x30 cm Ground Plane	RTK DISABLED	48.11 cm	57.8 cm	115.61 cm	21
	RTK ENABLED	1.17 cm	1.4 cm	2.8 cm	21

RTK Availability
Free Space

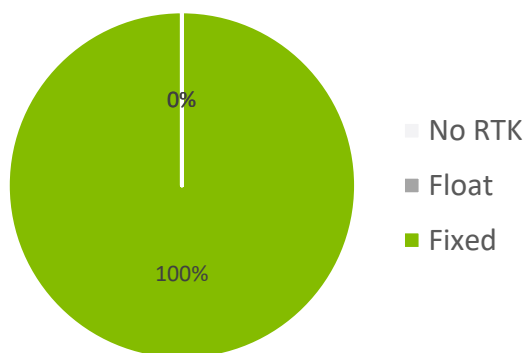

RTK Availability
30x30 cm GP

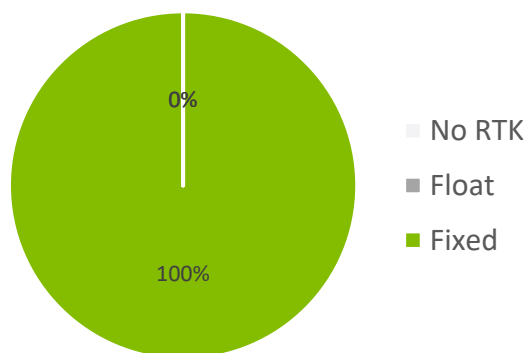

2. U-blox ZED F9P

- Multi-band GNSS: 184-channel
- GPS L1C/A L2C, GLONASS: L1OF L2OF, Galileo: E1B/C E5b, BeiDou: B1I B2I, QZSS: L1C/A L2C
- Multi-band RTK with fast convergence times and reliable performance
- Nav. update rate RTK up to 20 Hz
- Position accuracy = RTK 0.01 m + 1 ppm CEP

Positioning Accuracy Table (2D Accuracy)					
Test Condition	Correction Service	CEP (50%)	DRMS (68%)	2DRMS (95-98.2%)	TTFF (sec)
Free Space	RTK DISABLED	42.78 cm	55.74 cm	111.48 cm	23
	RTK ENABLED	1.57 cm	1.9 cm	3.81 cm	23
30x30 cm Ground Plane	RTK DISABLED	30.52 cm	36.91 cm	73.83 cm	19
	RTK ENABLED	0.58 cm	0.69 cm	1.39 cm	19

RTK Availability
Free Space

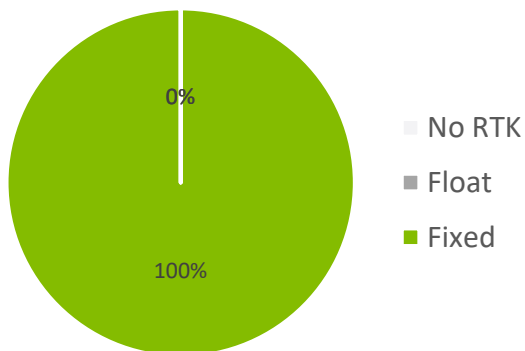

RTK Availability
30x30 cm GP

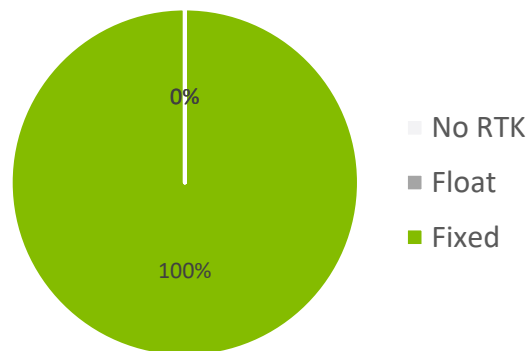

7. Mechanical Drawing

ISO NO.: EDW-20-8-0021

STATE: Release

NOTES:

REV	ZONE	DESCRIPTION	ENG	APPROVED	DATE
D01	ALL	Initial design	Joey	Clark	2020/02/11
D02	ALL	Add CE And WEEE logo Label	Aron Yan	Aaron	2020/06/29
D03	ALL	Cancel the CE mark	Aron Yan	Aaron	2020/10/14

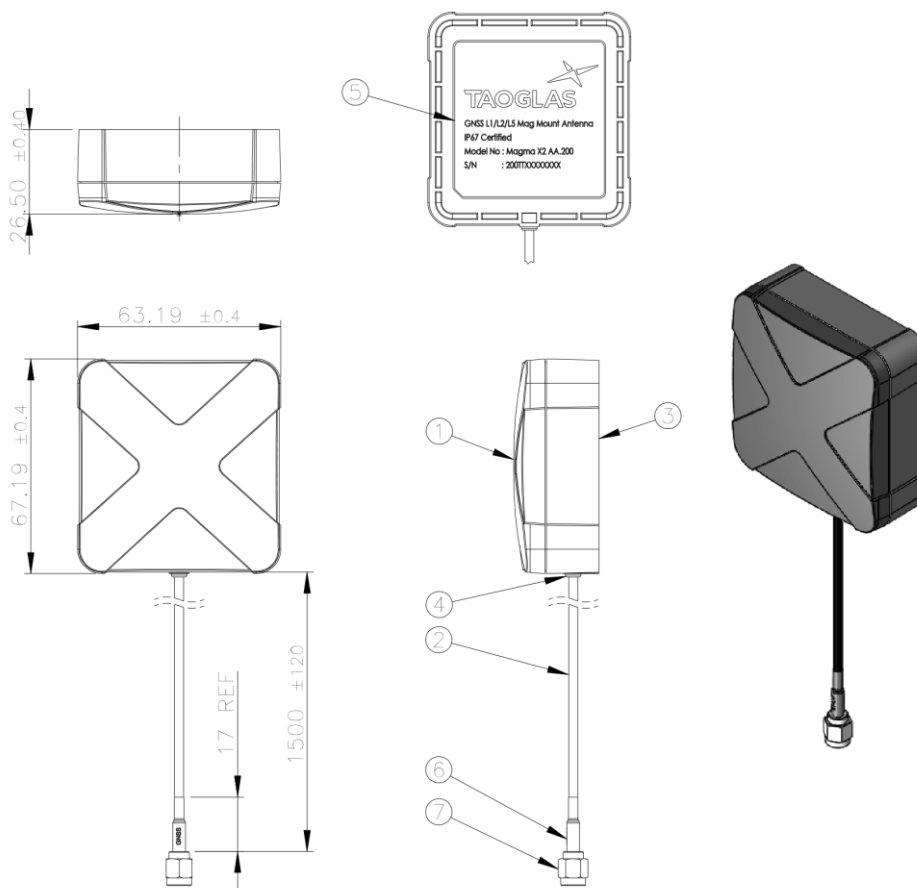

	Name	Material	Finish	QTY
1	Top Housing	ABS	Black	1
2	RG174 Coaxial Cable	PVC	Black	1
3	Bottom Housing	ABS	Black	1
4	Silicon Rubber	Silicone	Black	1
5	AA.200 Label	PET	Matte Silver	1
6	Heat Shrink Tube (GNSS)	PE	Blue Tube/White Text	1
7	SMA(M)ST	Brass	Au Plated	1

APPROVED BY:	TW Design Centre <small>This drawing and its inherent design concepts are property of Taoglas. Not to be copied or given to third parties without the written consent of Taoglas.</small>				
CHECK BY: Clark					
DRAWN BY: Joey	TITLE : GNSS L1/L2/L5 External 1500mm RG-174 SMA(M)ST				
DATE: 2020/2/11	PART NO. : AA.200.151111				
UNLESS OTHERWISE SPECIFIED TOLERANCES ON: .XX±0.5 .X±0.3 .X±0.2 .XX±0.4 .XXX±0.5 .XXX±0.25	THIRD ANGLE PROJECTION	UNIT: mm	SCALE: 1:2	PAGES: 1/1	REV: D03

8. Packaging

1pcs AA.200.151111 per Small PE Bag
Weight - 165g



10pcs AA.200.151111 per Large PE Bag
Weight – 1650g

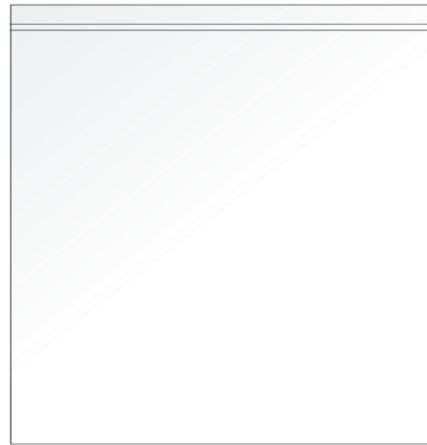

100pcs AA.200.151111 per carton
Dimensions - 370*370*300mm
Weight – 17Kg

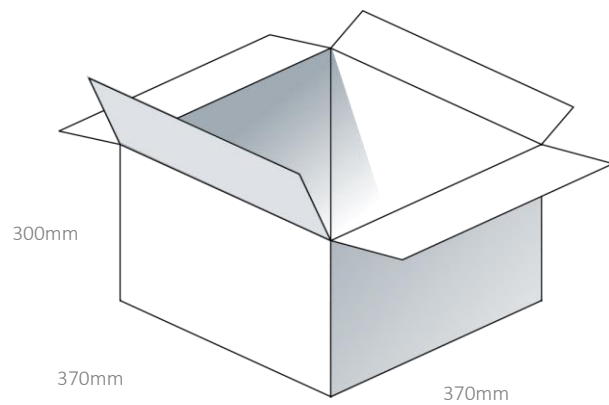

Changelog for the datasheet

SPE-20-8-002 – AA.200.151111

Revision: E (Current version)

Date:	2021-09-03
Notes:	Updated Mechanical Drawing
Author:	Gary West

Previous Revisions

Revision: D

Date:	2021-08-13
Notes:	Updated Drawing
Author:	Jack Conroy

Revision: C

Date:	2020-06-30
Notes:	Updated Data and graphs
Author:	Jack Conroy

Revision: B

Date:	2020-05-28
Notes:	Added Field Test Results
Author:	Victor Pinazo

Revision: A (Original First Release)

Date:	2020-03-31
Notes:	Initial Release
Author:	Jack Conroy



TAOGLAS®

www.taoglas.com



X-ON Electronics

Largest Supplier of Electrical and Electronic Components

Click to view similar products for [Antennas](#) category:

Click to view products by [Taoglas](#) manufacturer:

Other Similar products are found below :

[GAN30084EU](#) [930-033-R](#) [GW17.07.0250E](#) [1513563-1](#) [EXE902SM](#) [APAMPG-117](#) [MAF94383](#) [W3908B0100](#) [W6102B0100](#) [YE572113-30RSMM](#) [108-00014-50](#) [66089-2406](#) [SPDA17RP918](#) [A09-F8NF-M](#) [A09-F5NF-M](#) [RGFRA1903041A1T](#) [W3593B0100](#) [W3921B0100](#) [SIMNA-868](#) [SIMNA-915](#) [SIMNA-433](#) [W1044](#) [W1049B090](#) [A75-001](#) [WTL2449CQ1-FRSMM](#) [CPL9C](#) [EXB148BN](#) [0600-00060](#) [TRA9020S3PBN-001](#) [Y4503](#) [GD5W-28P-NF](#) [MA9-7N](#) [GD53-25](#) [GD5W-21P-NF](#) [C37](#) [MAF94051](#) [MA9-5N](#) [EXD420PL](#) [B1322NR](#) [QWFTB120](#) [MAF94271](#) [MAF94300](#) [GPSMB301](#) [FG4403](#) [AO-AGSM-OM54](#) [5200232](#) [MIKROE-2349](#) [WCM.01.0111](#) [MIKROE-2393](#) [MIKROE-2352](#)