



TAOGLAS®



Datasheet

Part No:
ADFGP.50A.07.0100C

Description:

Embedded Active GNSS Dual Stacked Patch Antenna
with 100mm of 1.37 & IPEX MHFI

Features:

Embedded Dual Patch, Dual Feed 4-Pin Assembly

Covering Bands:

- GPS/QZSS (L1/L2)
- GPS/QZSS/IRNSS (L5)
- Galileo (E1/E5a/E5b)
- GLONASS (G1/G2/G3)
- BeiDou (B1/B2a/B2b)

Low Axial Ratio

Cable: 100mm of 1.37mm

Connector: IPEX MHFI (U.FL)

Dimensions: 50 x 50 x 16.8mm

RoHS & Reach Compliant

1.	Introduction	3
2.	Specifications	5
3.	Antenna Characteristics	9
4.	Radiation Patterns	13
5.	LNA Characteristics	19
6.	Field Test Result	21
7.	Mechanical Drawing	22
8.	Packaging	23
<hr/>		
	Changelog	24

Taoglas makes no warranties based on the accuracy or completeness of the contents of this document and reserves the right to make changes to specifications and product descriptions at any time without notice. Taoglas reserves all rights to this document and the information contained herein. Reproduction, use or disclosure to third parties without express permission is strictly prohibited.

1. Introduction



The ADFGP.50A, with Taoglas Sure Technology, is a precision-engineered active dual patch, dual-feed antenna for GPS (L1/L2/L5), GLONASS (G1/G2/G5), Galileo (E1/E5a/E5b) and BeiDou (B1/B2). The antenna comes mounted on a 50*50 mm PCB (ground plane). It consists of two stacked patches, 50mm, and 40mm in width and is 16.8mm thick. It has been tuned and tested on a 50*50mm ground plane specifically for GPS L1: 1575.42MHz, L2: 1227.6MHz and L5: 1176.45MHz as well as the GLONASS, Galileo, BeiDou and IRNSS bands shown in Section 2.

Each patch element uses two orthogonal feeds that are combined in a hybrid coupler to ensure optimal axial ratio. The antenna exhibits excellent gain and good radiation pattern stability leading to a reliable GNSS fix in areas of weaker signal strength. All these elements combined ensure the best possible positional accuracy for your device. Taoglas makes no warranties based on the accuracy or completeness of the contents of this document and reserves the right to make changes to specifications and product descriptions at any time without notice. Taoglas reserves all rights to this document and the information contained herein.

Both patch elements have a dual pin feed to ensure a low axial ratio and should be used in conjunction with a hybrid coupler. The ADFGP.50A includes LNAs and front-end SAW filters to reduce out of band noise, such as from nearby cellular transceivers. It offers better protection from nearby radiated power surges and greatly reduces the probability of damaging your GNSS receiver from nearby transmissions.

Reproduction, use or disclosure to third parties without express permission is strictly prohibited. Copyright © Taoglas Ltd.

as from nearby cellular transceivers. It offers better protection from nearby radiated power surges and greatly reduces the probability of damaging your GNSS receiver from nearby transmissions.



- Excellent signal to noise ratio (C/N0)
- Good 2DRMS and fast TTFF
- Axial ratio < 2dB typ. across all bands
- Phase stability provides excellent Phase Center Variation (PCV)

Benefits:

- Excellent positional accuracy
- Great for use in difficult environments
- Multiband improves the receiver's position estimation in terms of accuracy and reliability
- Ideal antenna solution for multiband RTK systems.

The ADFGP.50A is connected via an IPEX MHFI connector and works well without modifications in most environments, however, it can be tuned and optimized for different ground planes and enclosures if required. It is manufactured and tested in a TS16949 first tier automotive approved facility.

Typical applications include:

- High accuracy positioning and navigation systems
- UAVs, Robotics & Autonomous Vehicles
- Micro-Mobility Solutions
- Mapping & GIS
- Transportation & Telematics
- Precision Agriculture
- Public Safety, Search & Rescue
- RTK Systems

Custom antenna modifications are subject to possible NRE and minimum order quantity. For further information or support to test and integrate Taoglas Sure technology please contact your regional Taoglas customer support team.

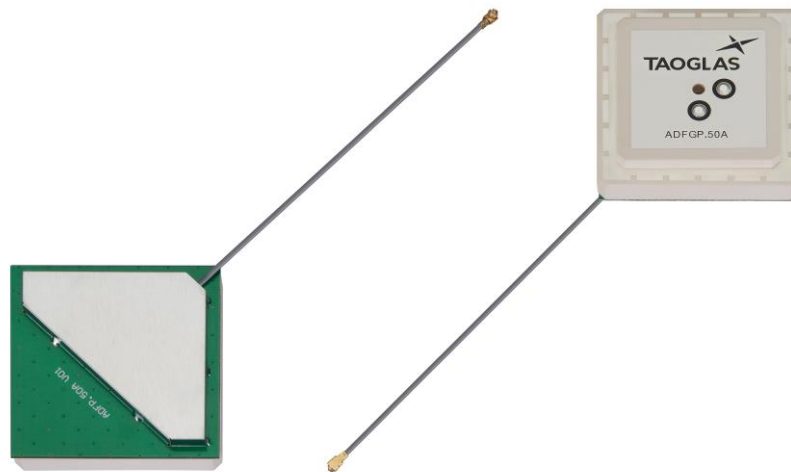

2. Specifications

GNSS Frequency Bands Covered						
GPS	L1	L2	L5			
	■	■	■			
GLONASS	G1	G2	G3			
	■	■	■			
Galileo	E1	E5a	E5b	E6		
	■	■	■	□		
BeiDou	B1	B2a	B2b	B3		
	■	■	■	□		
QZSS (Regional)	L1	L2C	L5	L6		
	■	■	■	□		
IRNSS (Regional)	L5					
	■					
SBAS	L1/E1/B1	L5/B2a/E5a	G1	G2	G3	
	■	■	■	■	■	

*SBAS systems: WASS(L1/L5), EGNOS(E1/E5a), SD-CM(G1/G2/G3), SNAS(B1,B2a), GAGAN(L1/L5), QZSS(L1/L5), KAZZ(L1/L5).

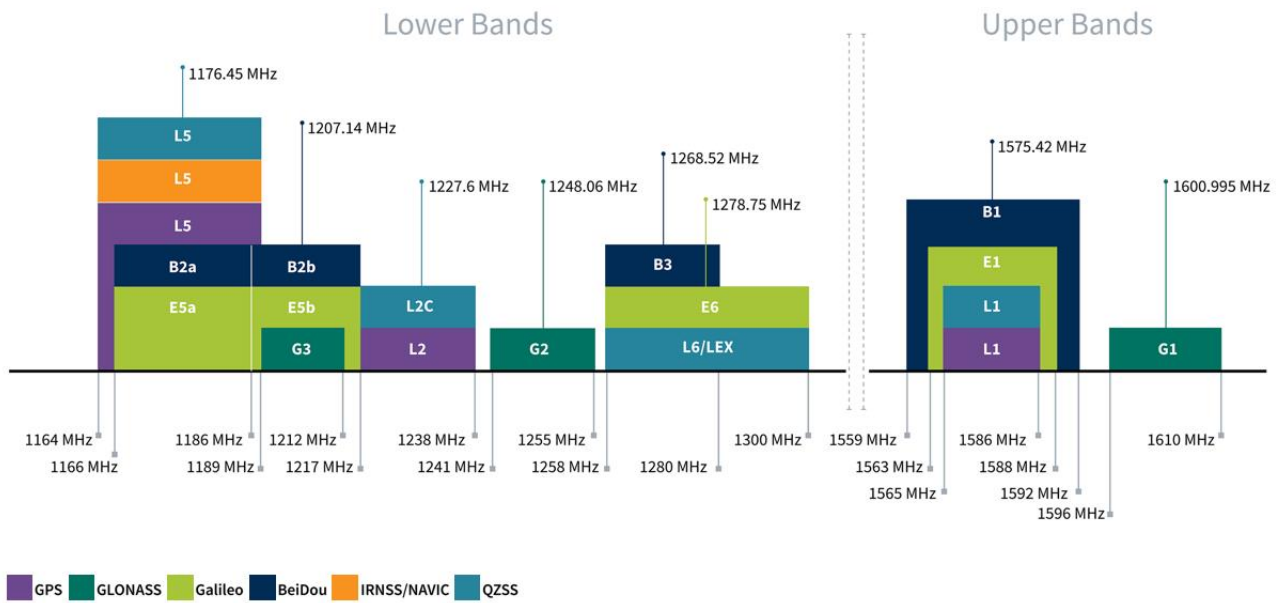

GNSS Bands and Constellations

GNSS Electrical					
Frequency (MHz)	1176.45	1227.6	1561	1575.42	1602
VSWR (max.)	2.0:1	2.0:1	2.0:1	2.0:1	2.0:1
Efficiency (%)	39.1%	43.7%	51.3%	62.8%	57.5%
Peak Gain at Zenith (dBi)	0.7	1.6	2.4	3.4	3.2
Axial Ratio (dB)	2.6	1.9	1.9	1.8	1.4
Group Delay	11	11	20	20	20
PCO (cm)	1	1.1	1.1	1.2	1.2
PCV (cm)	6	9	6	6	6
Polarization	RHCP				
Impedance	50Ω				

Note. The patch antenna test with hybrid coupler XC1400P-03S

LNA and Filter Electrical Properties					
Frequency (MHz)	1176.45	1227.6	1561	1575.42	1602
VSWR (max.)	2.0:1	2.0:1	2.0:1	2.0:1	2.0:1
Gain@1.8V (Typ.)	24.1dB	24.6dB	23.6dB	24.2 dB	23.7 dB

Gain@3.0V (Typ.)	24.1dB	24.6dB	23.7dB	24.2 dB	23.8 dB
Gain@5.5V (Typ.)	24.2dB	24.6dB	23.7dB	24.2 dB	23.8 dB
Noise@1.8V (Typ.)	5.15 dB	3.97 dB	2.74 dB	2.68 dB	2.72 dB
Noise@3.0V (Typ.)	5.15 dB	4.13 dB	2.75 dB	2.67 dB	2.74 dB
Noise@5.5V (Typ.)	5.12 dB	4.03 dB	2.72 dB	2.77 dB	2.81 dB
Power consumption@1.8V (Typ.)	17.95 mA				
Power consumption@3.0V (Typ.)	18.02 mA				
Power consumption@5.5V (Typ.)	18.05 mA				

Total Specification (Through Antenna, SAW Filter and LNA)

Frequency (MHz)	1176.45	1227.6	1561	1575.42	1602
Gain@3V (dBi)	24.8	26.2	26.1	27.6	27
Output Impedance	50 Ω				

Mechanical

Dimensions	50 x 50 x 16.8mm
Connector	IPEX MHFI (U.FL)
Cable	Coaxial Cable ϕ 1.37: Length 100mm
Weight	95.5g

Environmental

Operation Temperature	-40°C to 85°C
Storage Temperature	-40°C to 85°C
Humidity	Non-condensing 65°C 95% RH

3. Antenna Characteristics

3.1 Return Loss

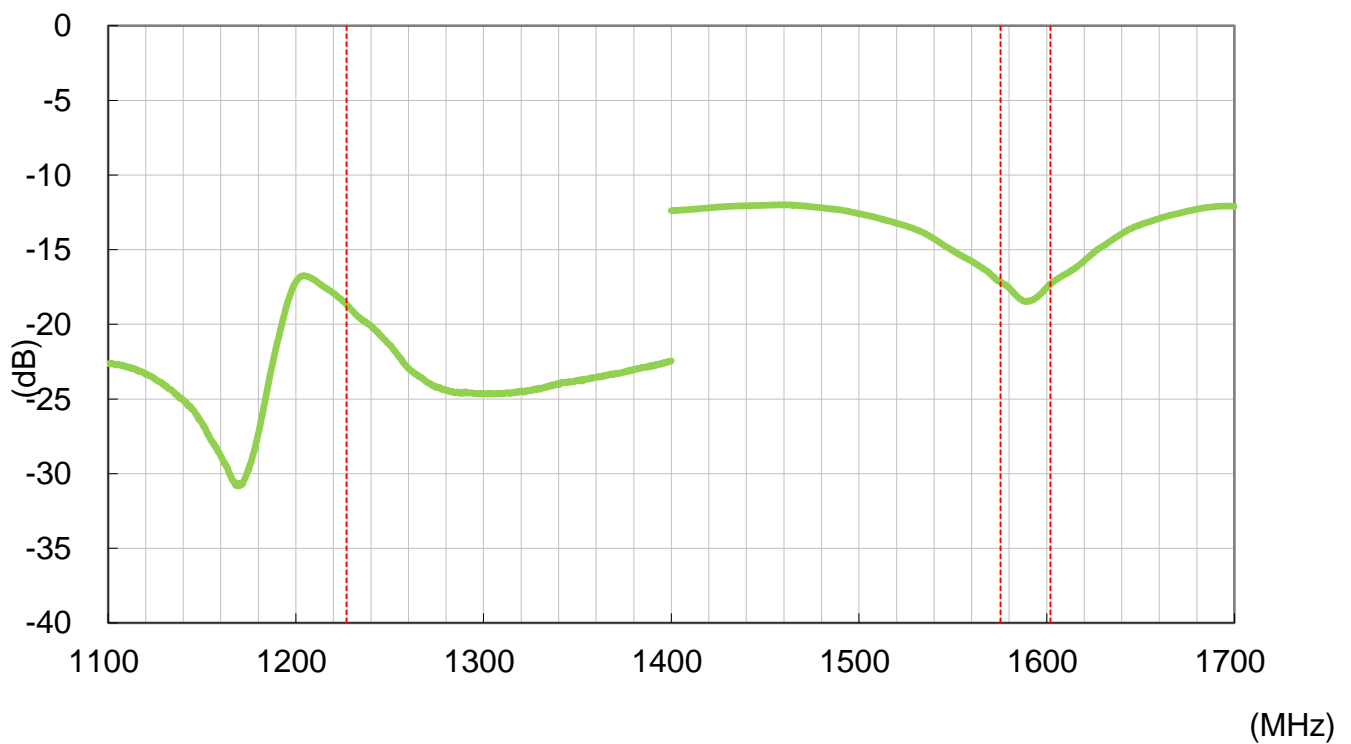

3.2 Efficiency

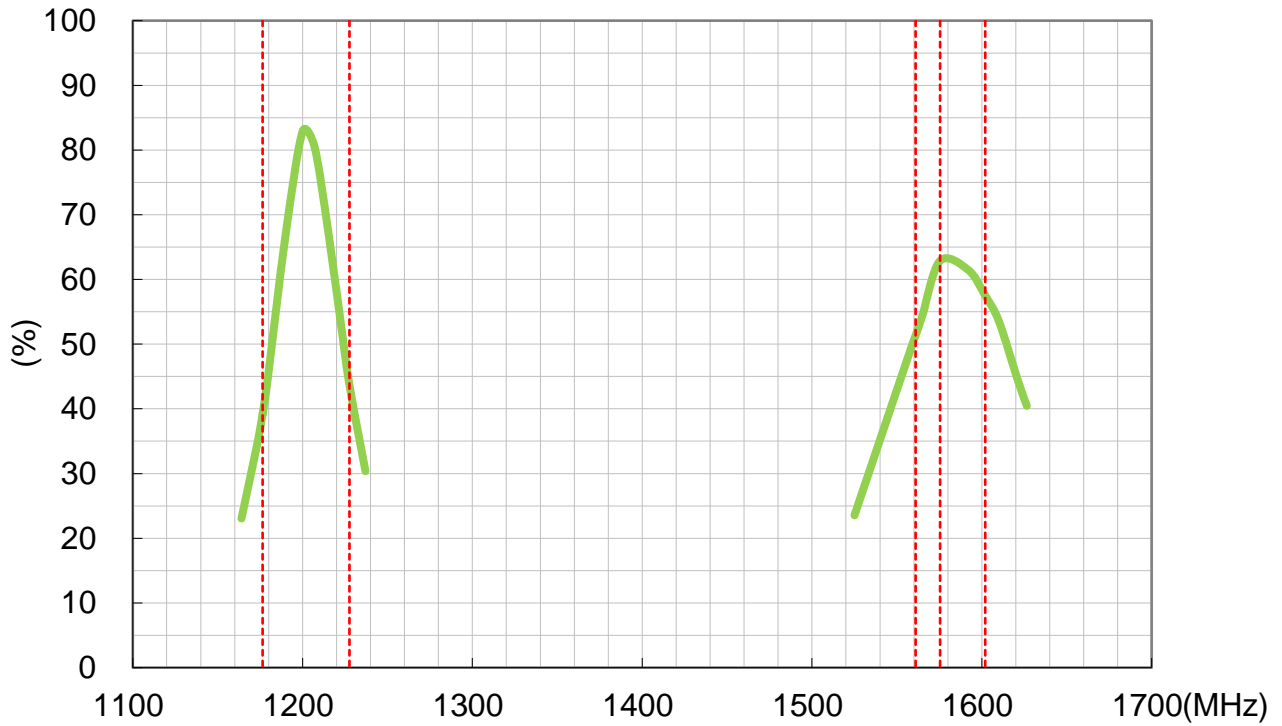

3.3 Average Gain

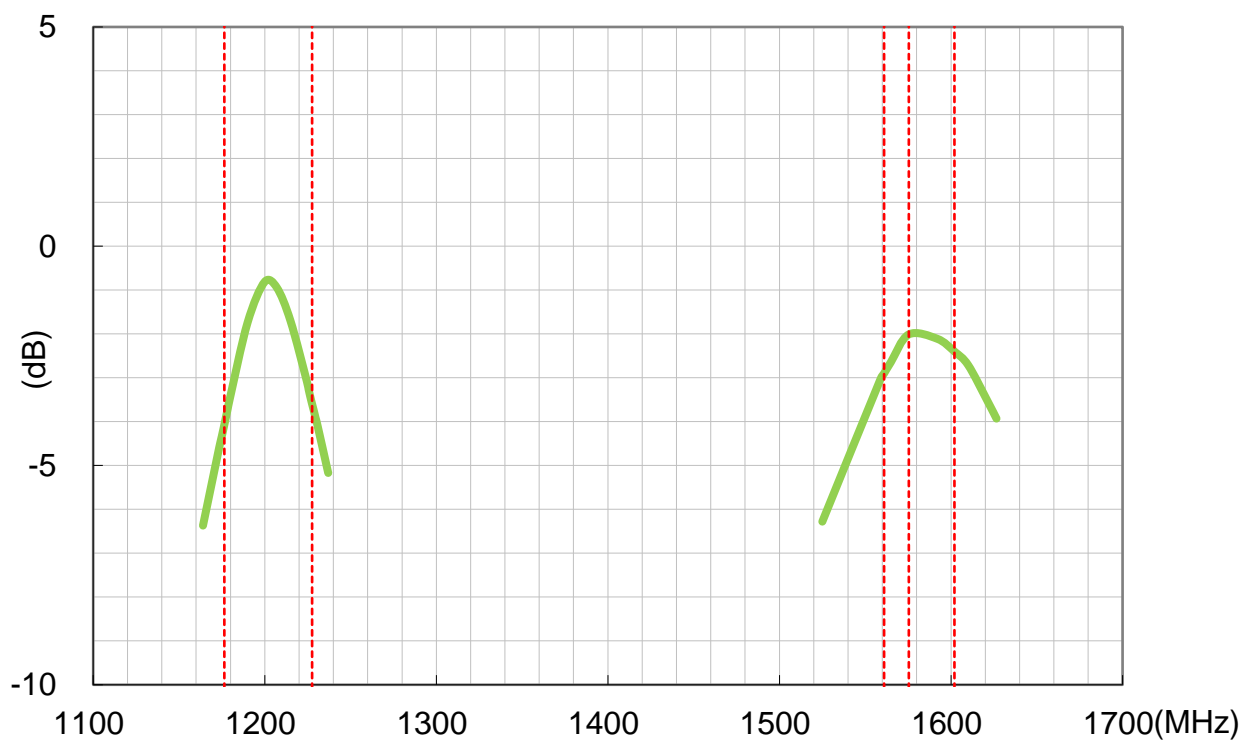

3.4 Peak Gain

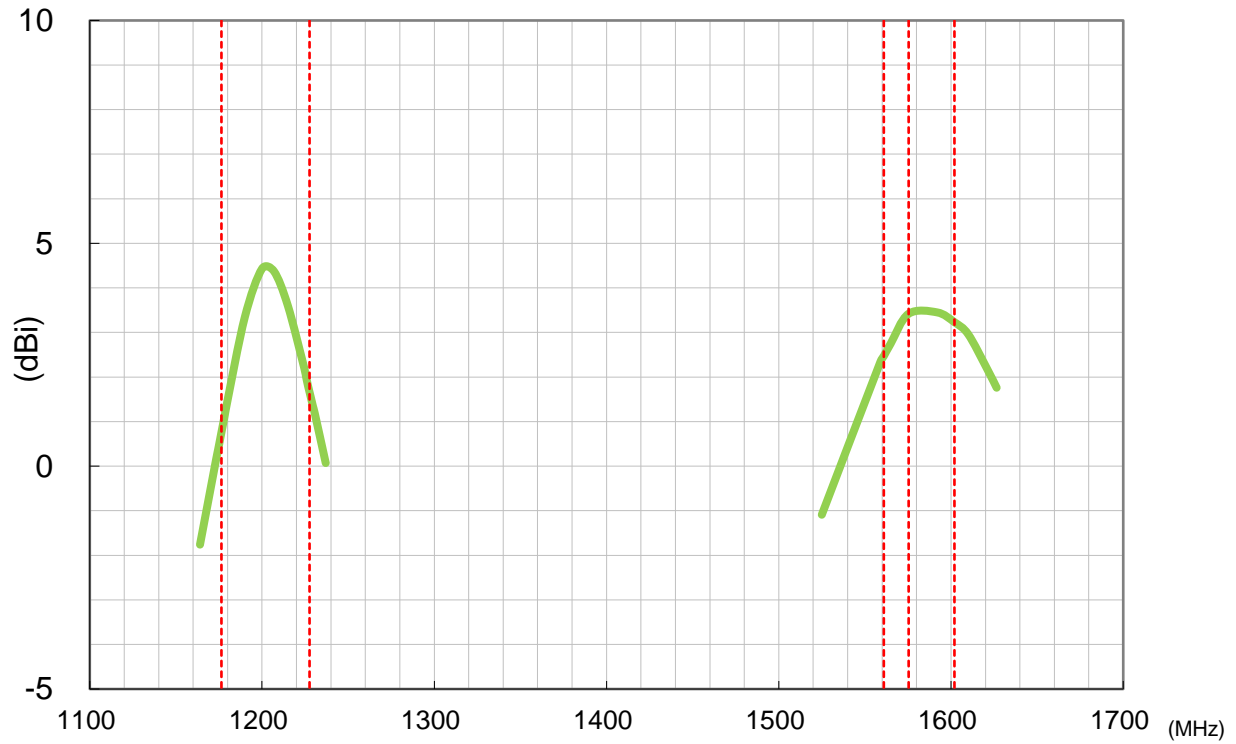

3.5 Axial Ratio

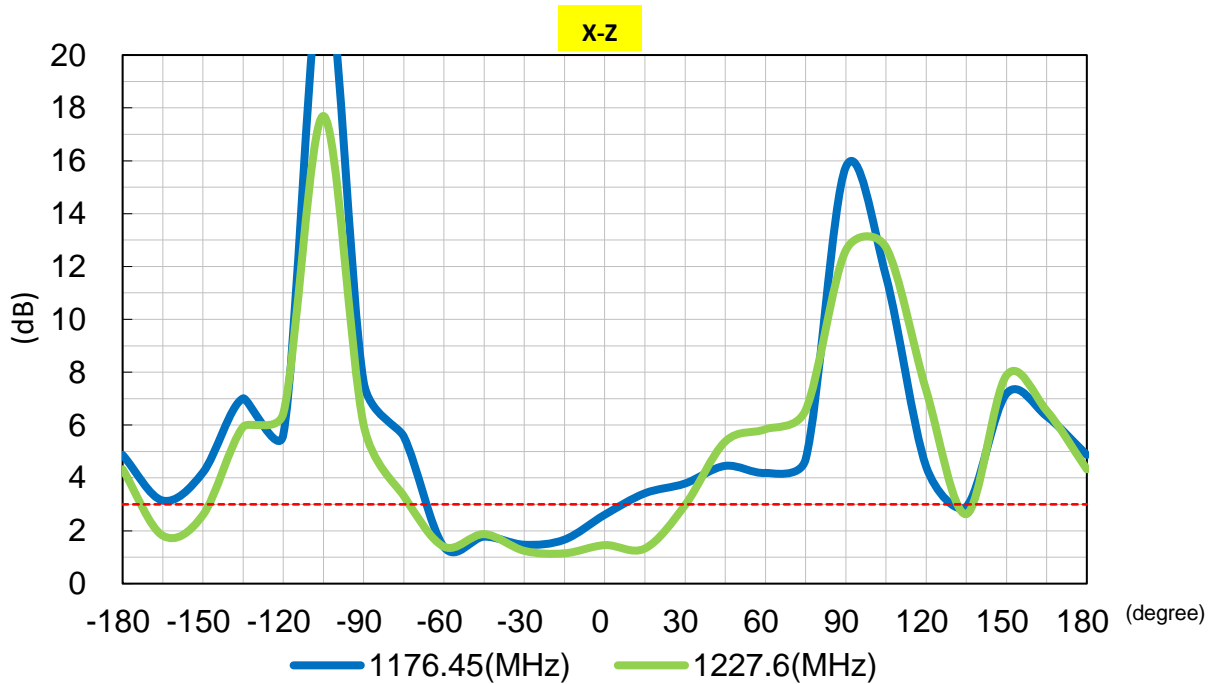

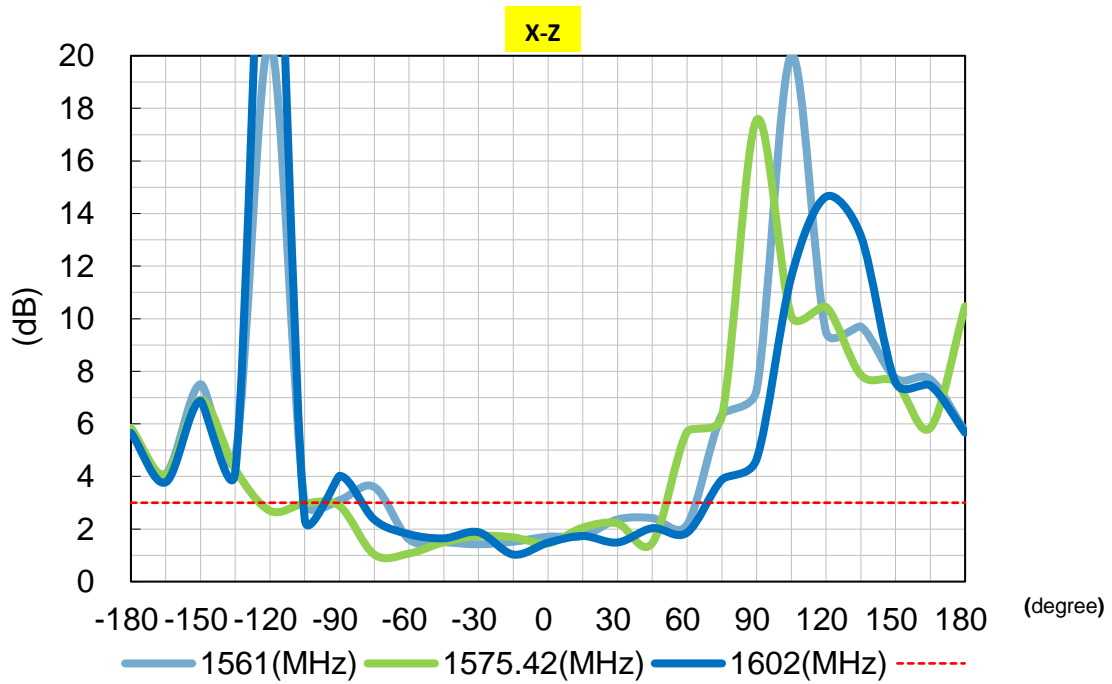
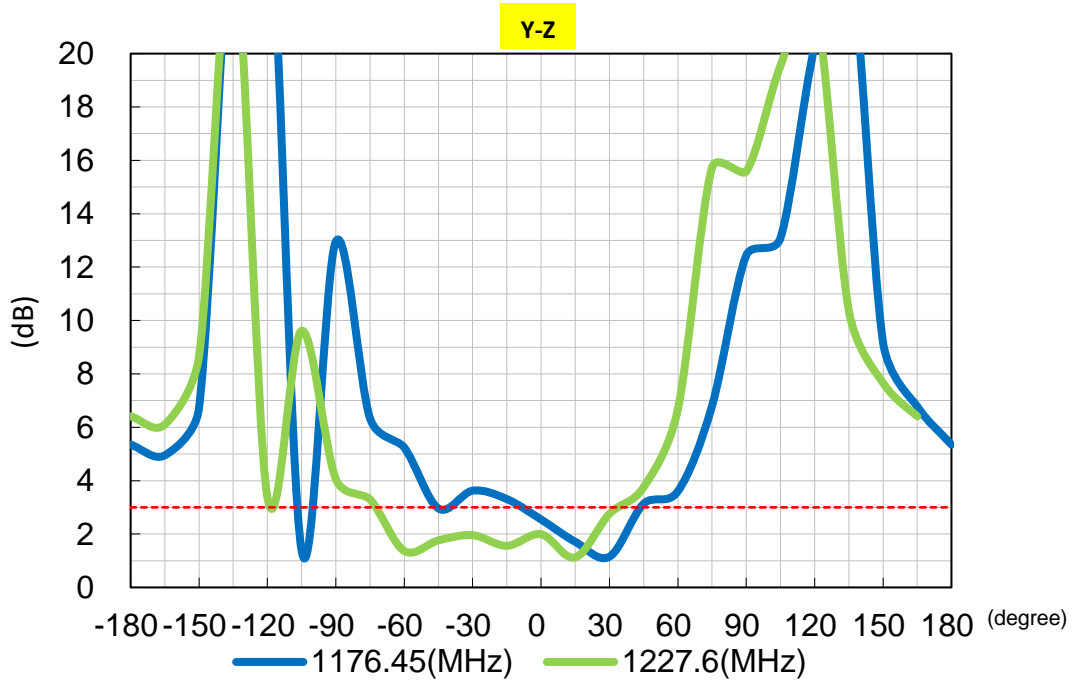

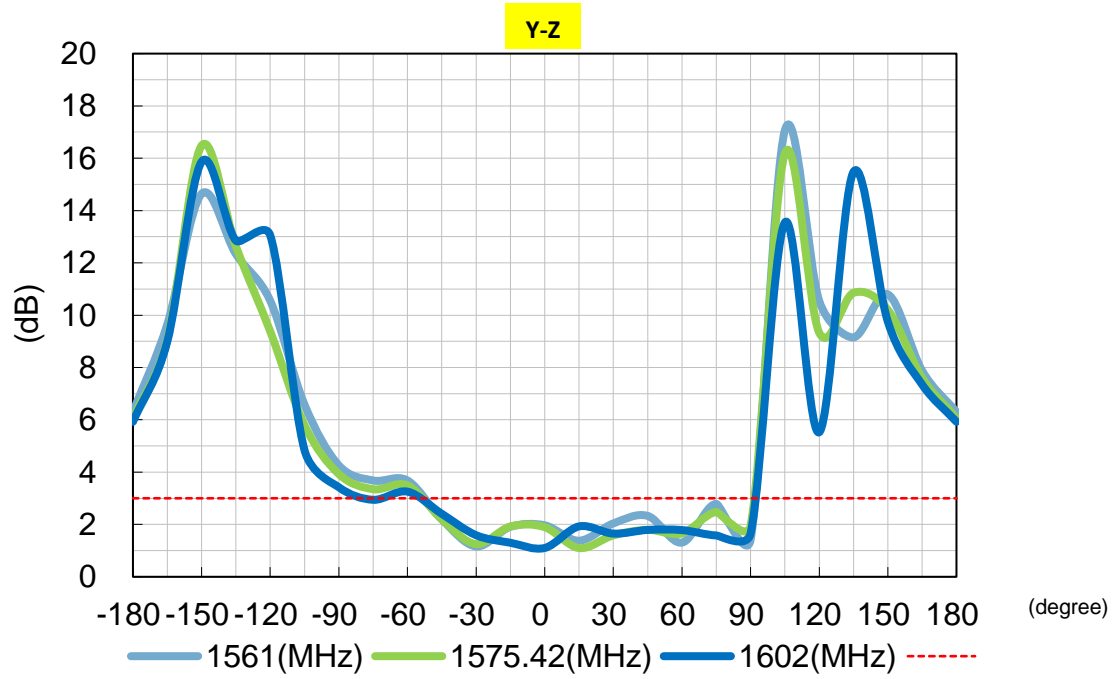

4. Radiation Patterns

4.1 Test Setup

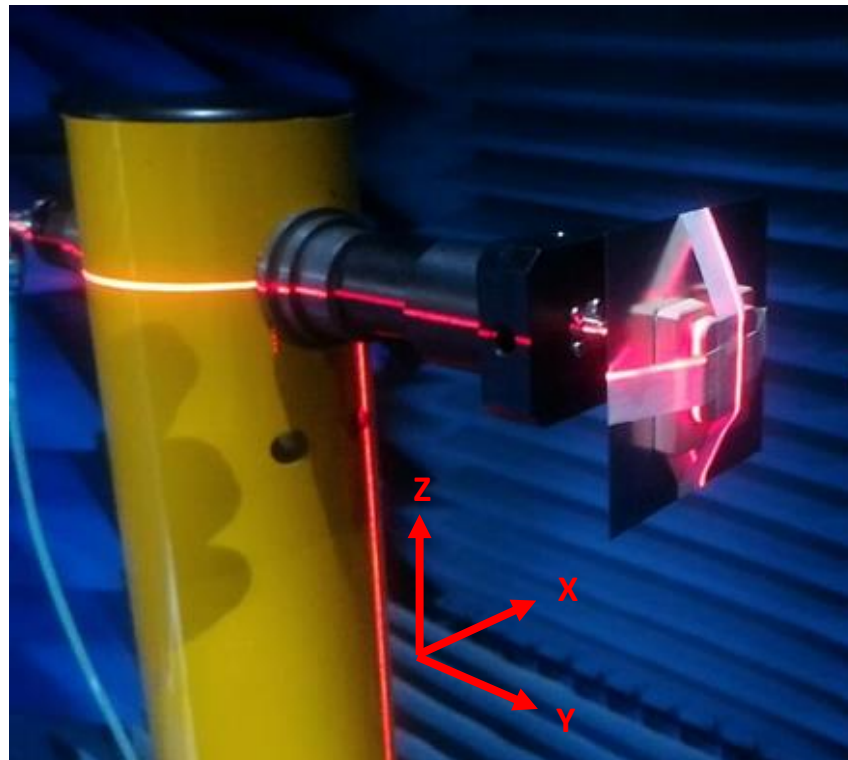

4.2 1176.45MHz 3D and 2D Radiation Patterns

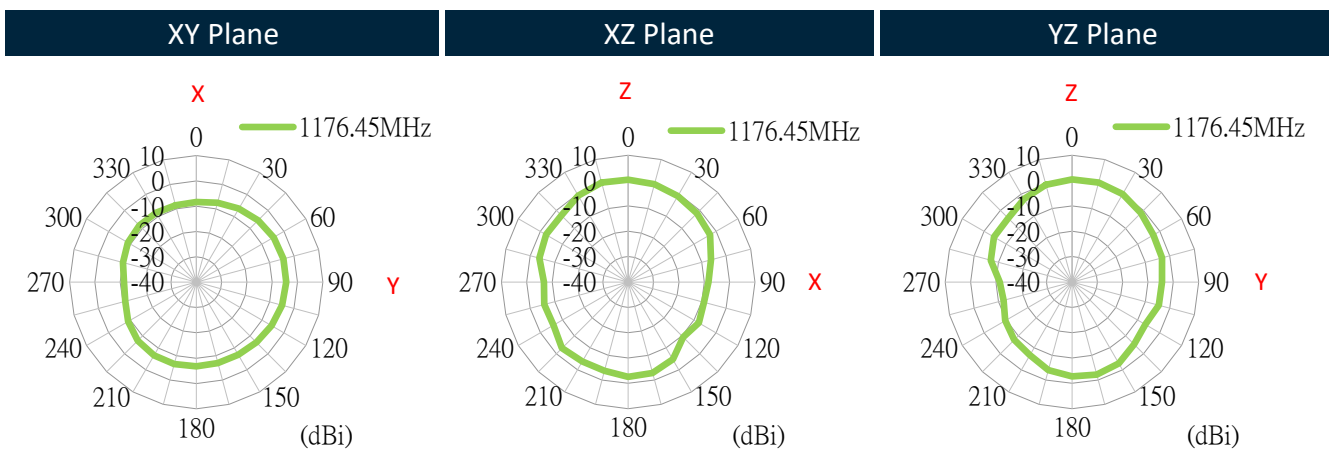
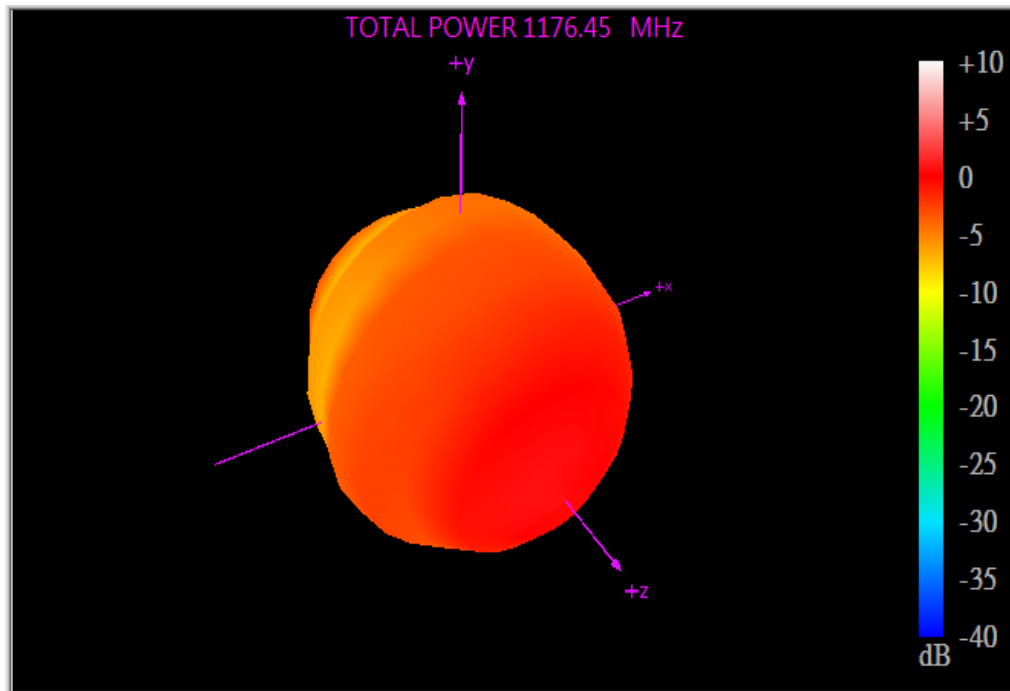

4.3 1227.6MHz 3D and 2D Radiation Patterns

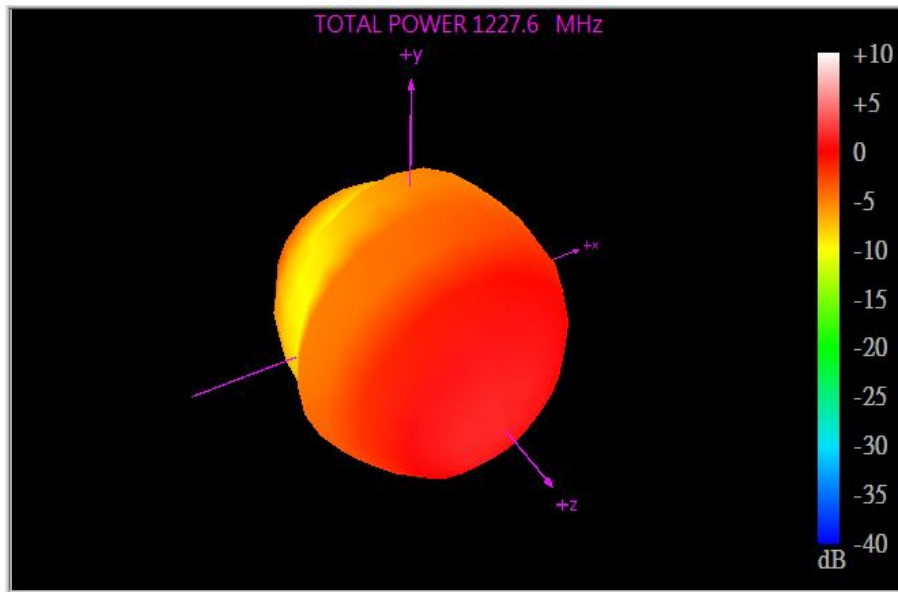

XY Plane

XZ Plane

YZ Plane

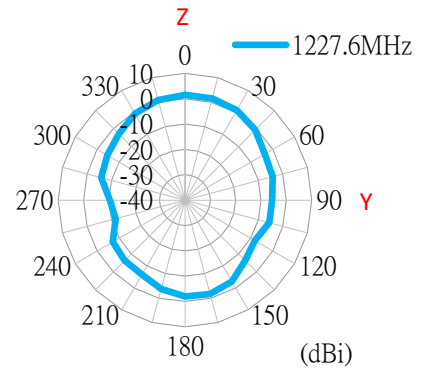
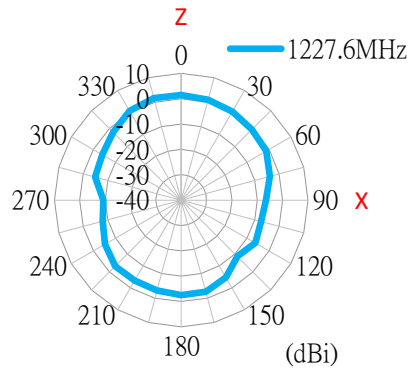
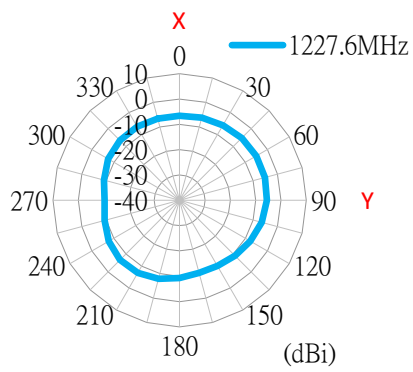

4.4 1561MHz 3D and 2D Radiation Patterns

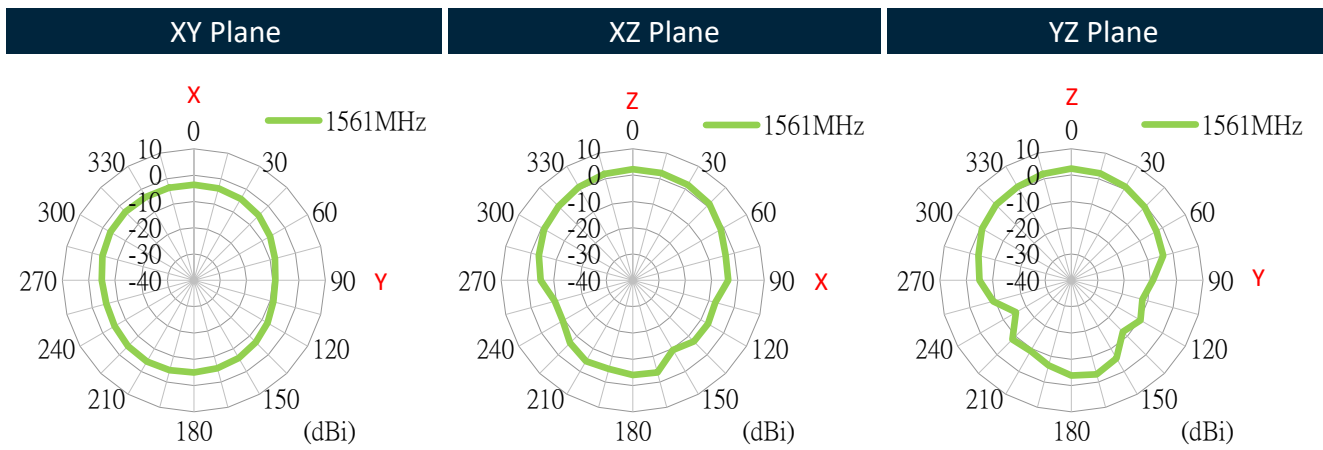
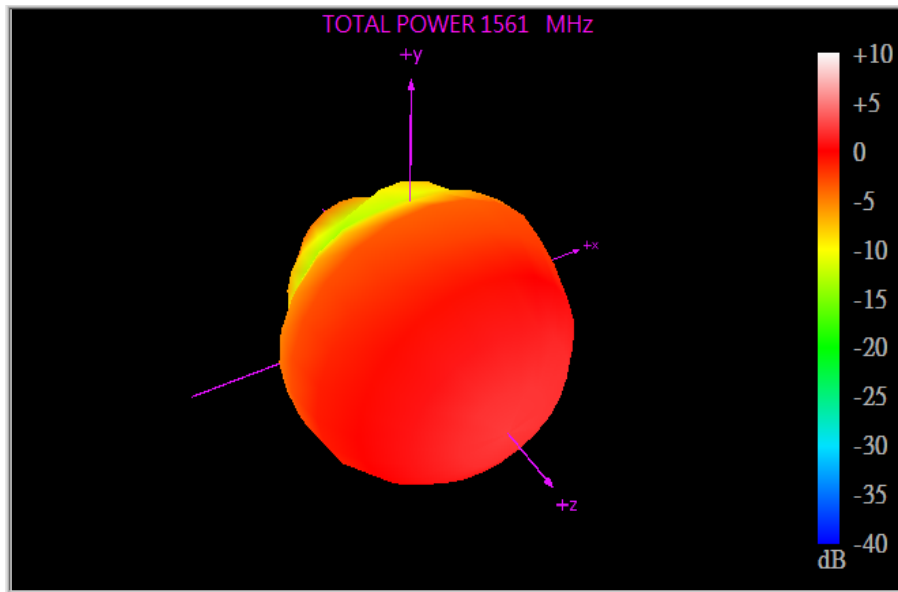

4.5 1575.42MHz 3D and 2D Radiation Patterns

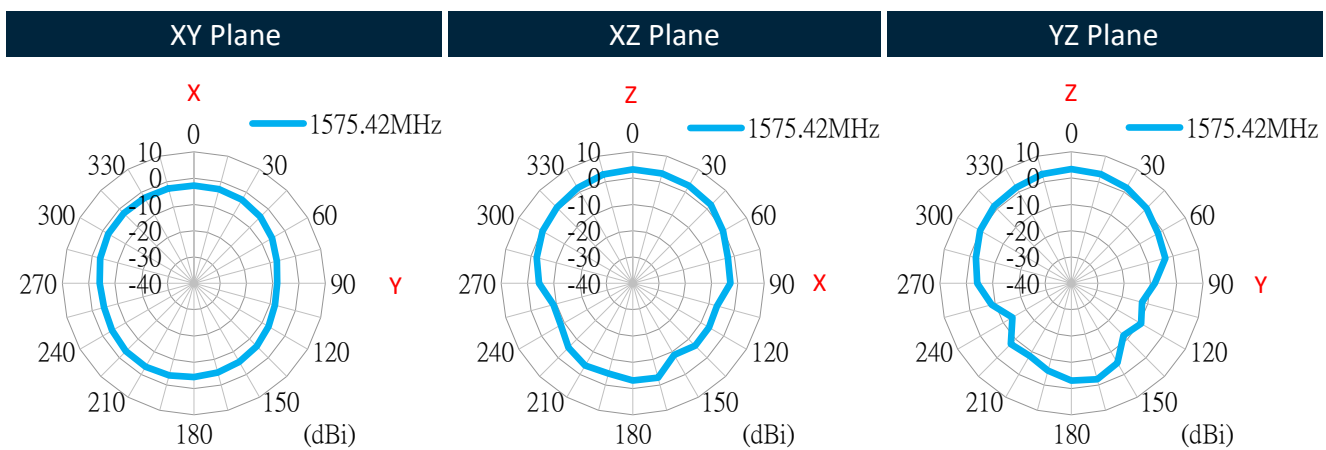
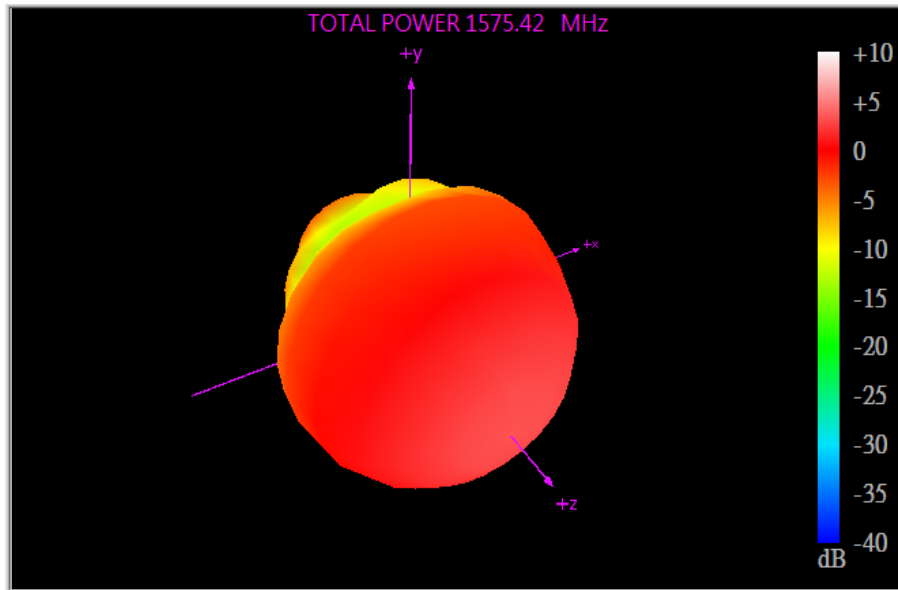

4.6 1602MHz 3D and 2D Radiation Patterns

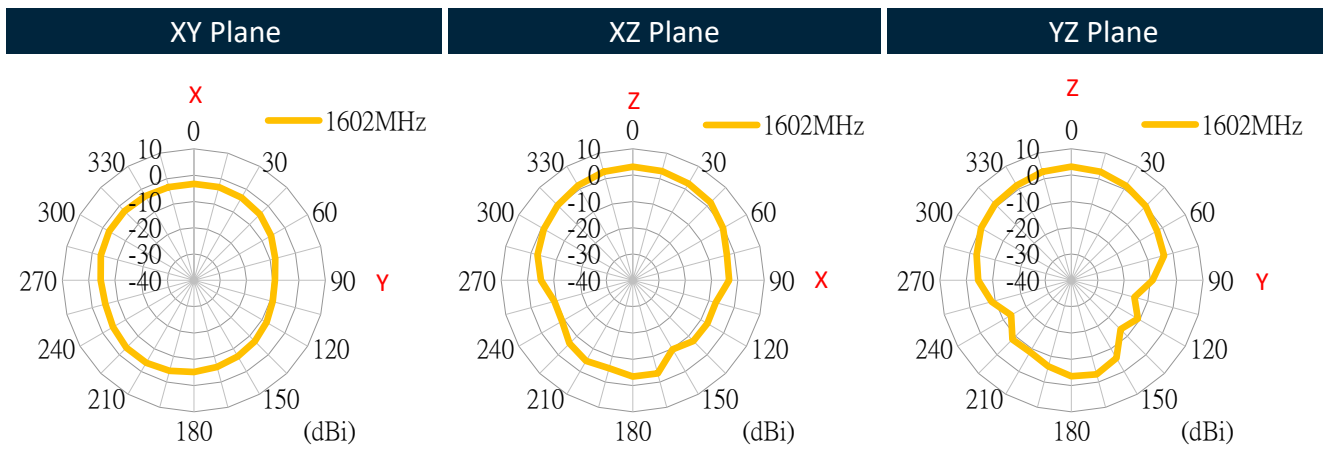
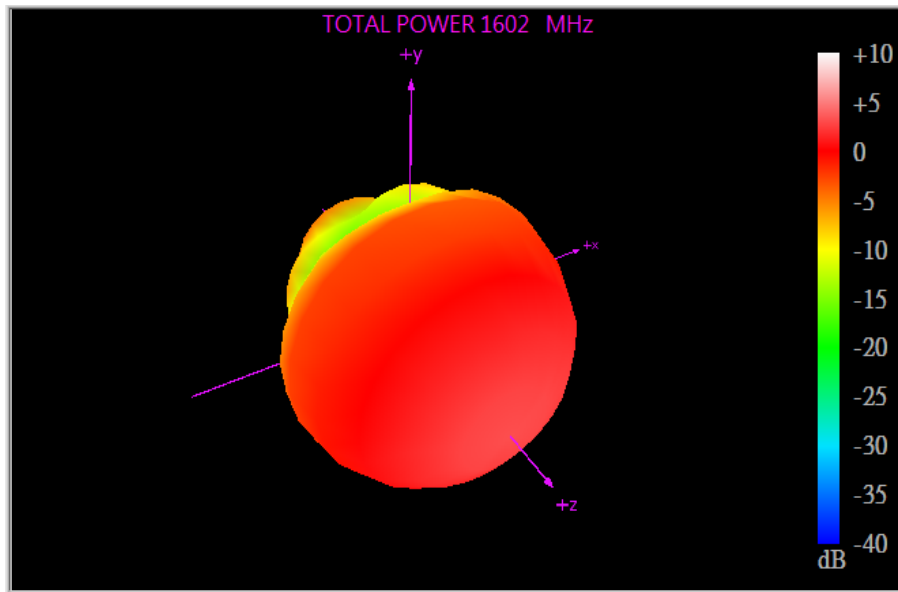

5. LNA Characteristics

5.1 Block Diagram (Active Antenna)

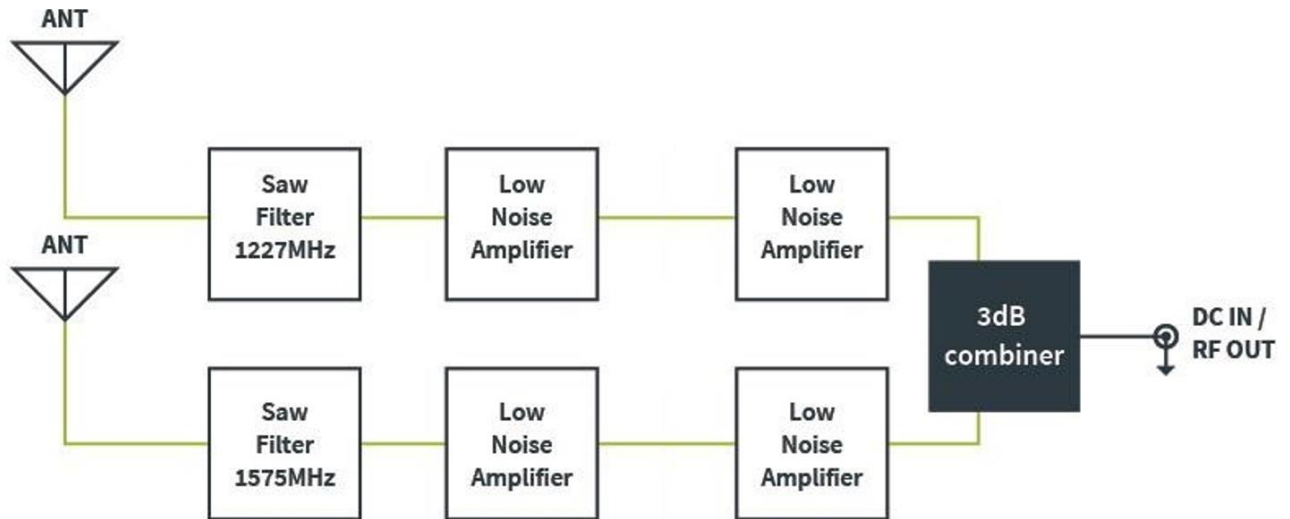

5.2 LNA Gain

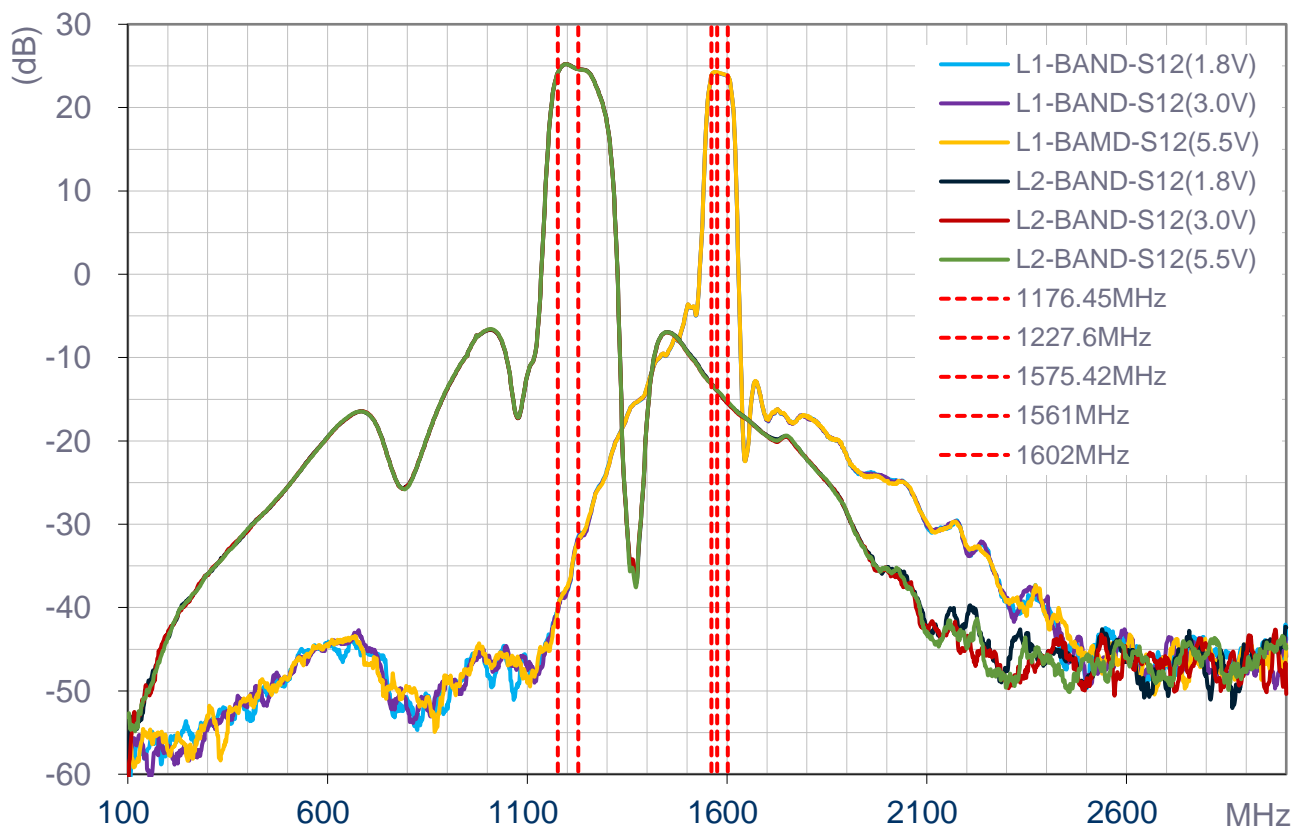

5.3 Noise Figure @3.0V

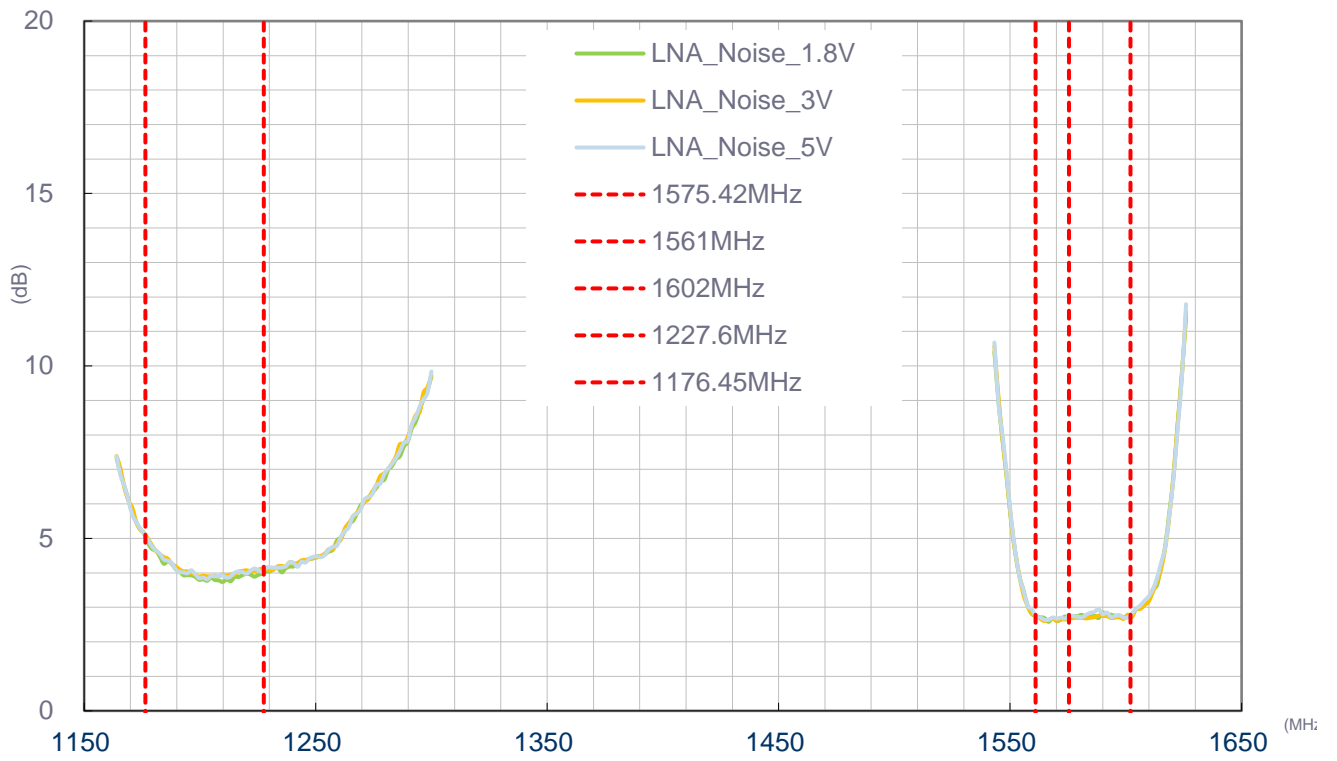

6. Field Test Results

6.1 Rooftop test

In this section Taoglas will present the field test result for ADFGP.50 antenna. The test was performed when the antenna was mounted on a static rooftop test set up in an open sky environment for at least **6 hours**.

Taoglas will show the field test results using the following receiver:

1. U-blox ZED-F9P

Receiver features:

- Multi-band GNSS: 184-channel GPS L1C/A L2C, GLONASS: L1OF L2OF, Galileo: E1B/C E5b, BeiDou: B1I B2I, QZSS: L1C/A L2C
- Multi-band RTK with fast convergence times and reliable performance
- Nav. update rate RTK up to 20 Hz
- Position accuracy = RTK 0.01 m + 1 ppm CEP

Positioning Accuracy Table (2D Accuracy)					
Test Condition	Correction Service	CEP (50%)	DRMS (68%)	2DRMS (95-98.2%)	TTF (sec)
Free Space	RTK DISABLED	56.42 cm	73.23 cm	146.46 cm	15
	RTL ENABLED	0.9 cm	1.08 cm	2.16 cm	15
30x30 cm Ground Plane	RTK DISABLED	46.69 cm	58.83 cm	117.65 cm	12
	RTL ENABLED	0.8 cm	0.96 cm	1.93 cm	12

RTK Availability
Free space

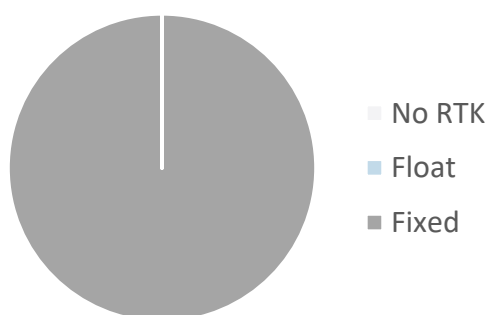

RTK Availability
30x30 cm ground plane

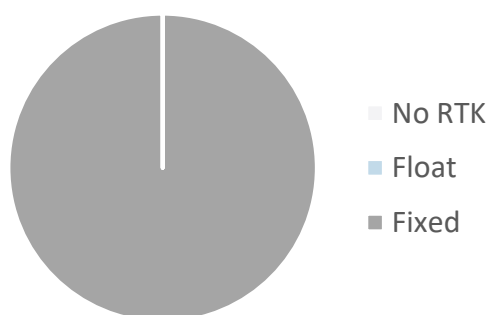

7. Mechanical Drawing (Units: mm)

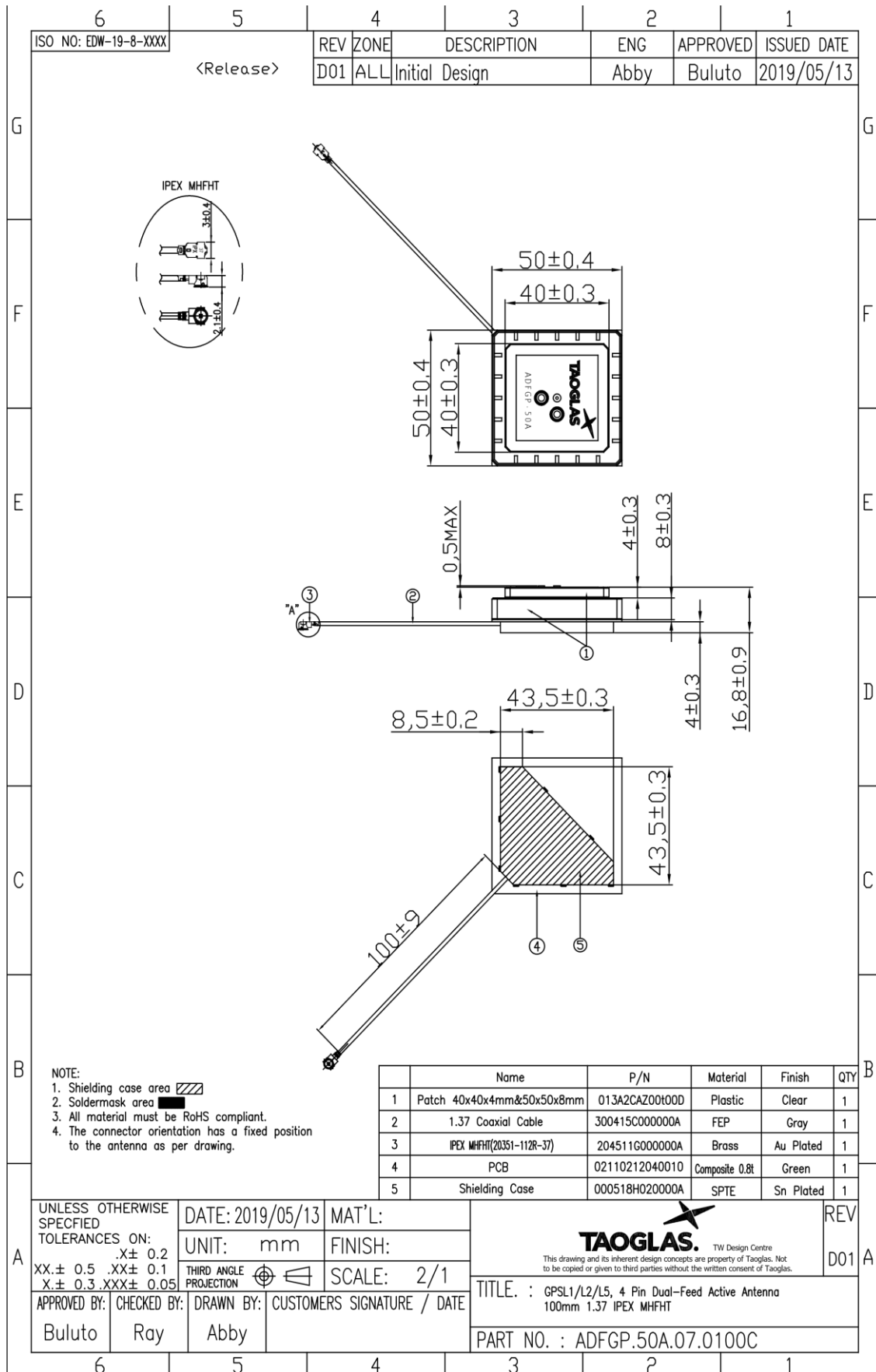

8. Packaging

8pcs ADFGP.50A.07.0100C per PE Bag
Weight: 800g



24pcs ADFGP.50A.07.0100C per carton
Dimensions: 256 x 154 x 96mm
Weight: 2600g

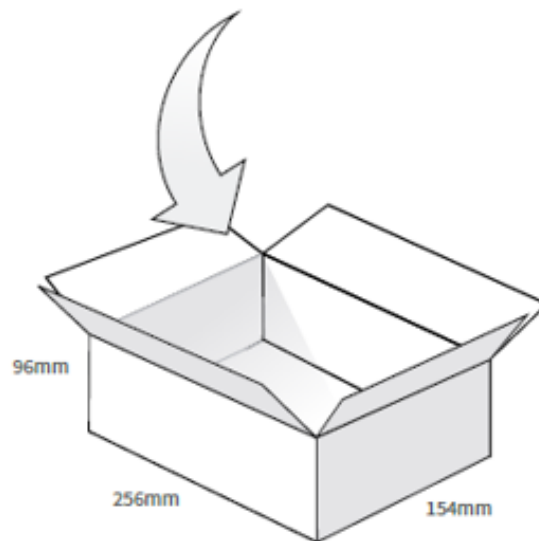

96pcs ADFGP.50A.07.0100C per large carton
Dimensions: 327 x 280 x 218mm
Weight: 11Kg

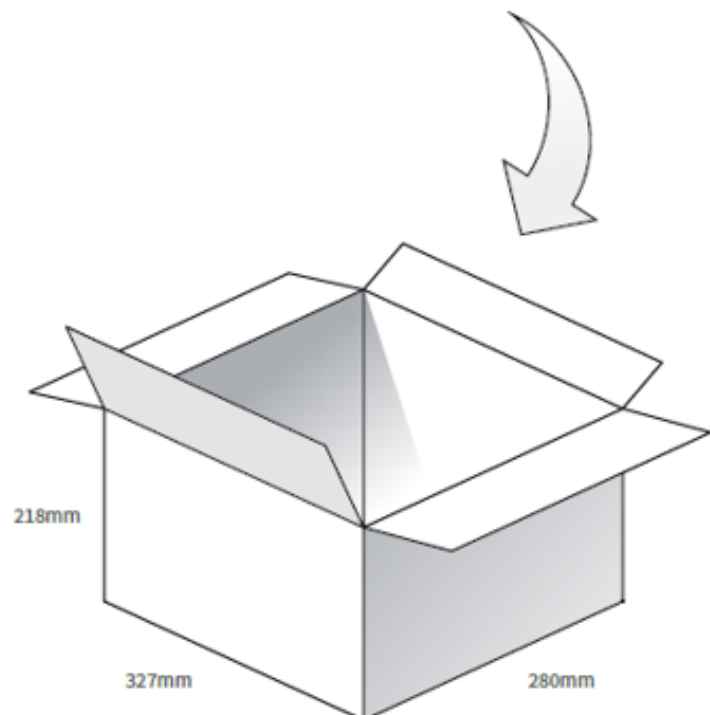

Changelog for the datasheet

SPE-19-8-133 – ADFGP.50A.07.0100C

Revision: D (Current Version)

Date:	2021-12-22
Changes:	Updated packaging
Changes Made by:	Gary West

Previous Revisions

Revision: C

Date:	2020-05-29
Changes:	Added Field Test Section
Changes Made by:	Victor Pinazo

Revision: B

Date:	2020-03-02
Changes:	Updated Introduction
Changes Made by:	Yu Kai Yeung

Revision: A

Date:	2019-10-17
Changes:	Initial Release
Changes Made by:	Jack Conroy



TAOGLAS®

www.taoglas.com

X-ON Electronics

Largest Supplier of Electrical and Electronic Components

Click to view similar products for [Antennas](#) category:

Click to view products by [Taoglas](#) manufacturer:

Other Similar products are found below :

[GAN30084EU](#) [930-033-R](#) [GW17.07.0250E](#) [1513563-1](#) [EXE902SM](#) [APAMPG-117](#) [MAF94383](#) [W3908B0100](#) [W6102B0100](#) [YE572113-30RSMM](#) [108-00014-50](#) [66089-2406](#) [SPDA17RP918](#) [A09-F8NF-M](#) [A09-F5NF-M](#) [RGFRA1903041A1T](#) [W3593B0100](#) [W3921B0100](#) [SIMNA-868](#) [SIMNA-915](#) [SIMNA-433](#) [W1044](#) [W1049B090](#) [A75-001](#) [WTL2449CQ1-FRSMM](#) [CPL9C](#) [EXB148BN](#) [0600-00060](#) [TRA9020S3PBN-001](#) [Y4503](#) [GD5W-28P-NF](#) [MA9-7N](#) [GD53-25](#) [GD5W-21P-NF](#) [C37](#) [MAF94051](#) [MA9-5N](#) [EXD420PL](#) [B1322NR](#) [QWFTB120](#) [MAF94271](#) [MAF94300](#) [GPSMB301](#) [FG4403](#) [AO-AGSM-OM54](#) [5200232](#) [MIKROE-2349](#) [WCM.01.0111](#) [MIKROE-2393](#) [MIKROE-2352](#)