

## SPECIFICATION

Part No. : **AP.25M.07.0080A**

Product Name : 25mm One Stage GPS/GALILEO Active Patch  
Antenna Module with front-end Saw Filter

Features : Industry leading GPS/GALILEO antenna performance  
25\*25\*6mm  
80mm Ø1.13 I-PEX MHFI (U.FL)  
15dB LNA  
Wide Input Voltage 1.8V to 5.5V  
Low Power Consumption  
**RoHS Compliant**



# 1. Introduction

The AP.25M is a one stage 25mm active patch antenna that has been designed specifically for embedded (inside device) integration with GPS/GALILEO receiver modules.

The AP.25M combines a 25\*25\*2mm advanced low profile ceramic patch antenna with a one stage LNA and a front-end SAW filter with ultra thin coaxial cable. It comes with it's own integrated ground-plane. The front end SAW filter reduces the risks where there is a cellular transmitter nearby of interference from out of band frequencies which can cause LNA burn-out, saturation, or radiated spurious emissions.

The antenna can work on a wide input voltage from 1.8V to 5.5V with best in class power consumption figures.

If further tuning and optimization specific to a customer device is required Taoglas offers a custom tuned and optimized part service. Contact [sales@taoglas.com](mailto:sales@taoglas.com) for more information. Cables and connectors can be customized according to request.

This antenna system consists of two functional blocks, the LNA portion and the patch antenna.

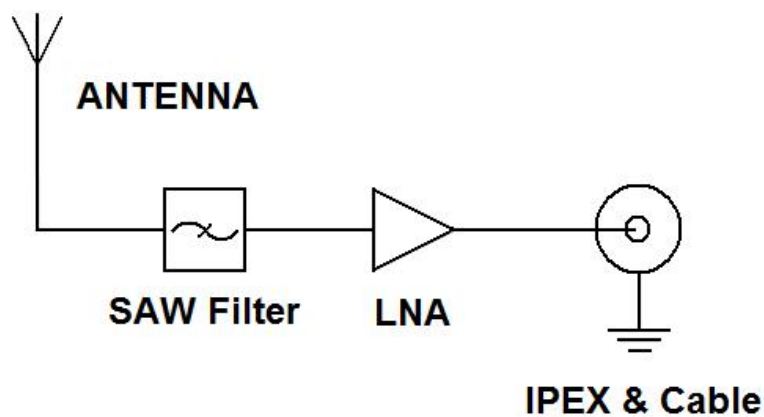

## 2. Specification

### 2.1. Patch Antenna

Parameter	Specification
Frequency	1575.42 ± 1.023MHz
Gain @ Zenith	+2.0 dBic Typ. @ Zenith
Polarization	RHCP
Axial Ratio	3.0dB max. @Zenith
Patch Dimension	25*25*2mm

### 2.2 LNA

Parameter	Specification		
Frequency	1575.42 ± 1.023MHz		
Outer Band Attenuation	F0=1575.42MHz		
	F0±30MHz 3dB min.		
	F0±50MHz 15dB min.		
	F0±100MHz 23dB min.		
Output Impedance	50Ω		
Output VSWR	2.0 Max		
Pout at 1dB Gain Compression point	Typ. -2dBm		
	Min. -6dBm		
LNA Gain, Power Consumption and Noise Figure			
Voltage	LNA Gain (Typ)	Power Consumption (Typ)	Noise Figure (Typ)
Min. 1.8V	13dB	2mA	2.5dB
Typ. 3.0V	15dB	4mA	2.5dB
Max. 5.5V	16dB	9mA	2.6dB

## 2.3 Cable\* & Connector

Parameter	Specification
RF Cable	Coaxial Cable $\varnothing 1.13 \pm 0.1\text{mm}$ , length $80 \pm 2.5\text{mm}$
Connector	IPEX MHFI (U.FL)

## 2.2. Total Specification (Through Antenna, LNA, Cable and Connector)

Parameter	Specification
Frequency	$1575.42 \pm 1.023\text{MHz}$
Gain	At 3V: $17 \pm 3\text{dBic}$ (At $90^\circ$ )
Output Impedance	$50\Omega$
Polarization	RHCP
Output VSWR	Max 2.0
Operation Temperature	$-40^\circ\text{C}$ to $+85^\circ\text{C}$
Storage Temperature	$-40^\circ\text{C}$ to $+85^\circ\text{C}$
Relative Humidity	40% to 95%
Input Voltage	Min:1.8V Typ. 3.0V Max:5V
Antenna	$25*25*6\text{mm}$

### 3. LNA Gain and Out Band Rejection @3.0V

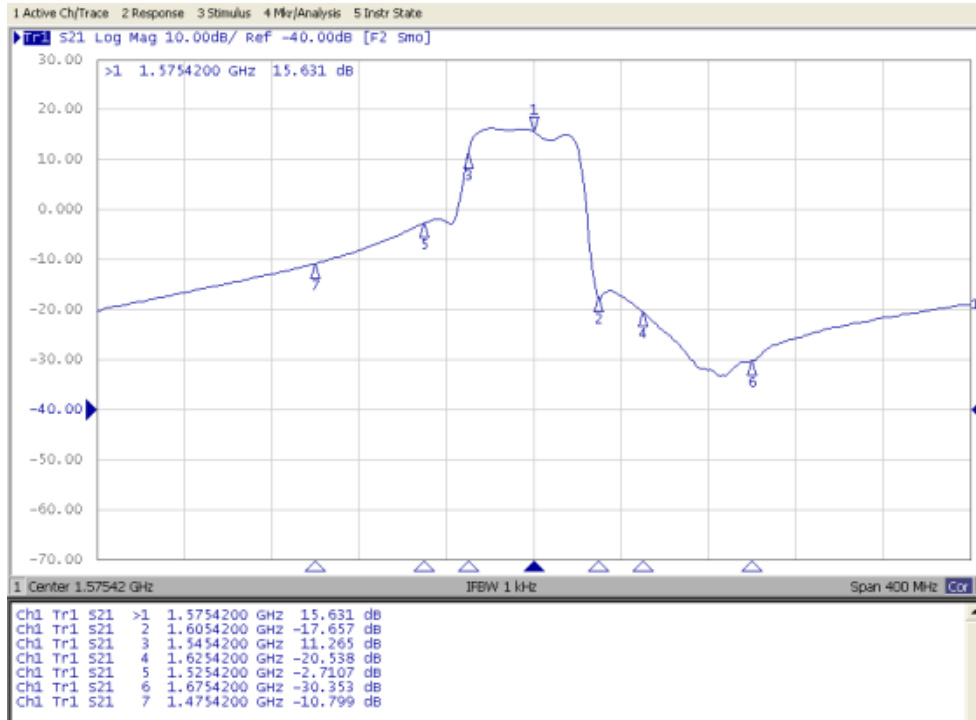

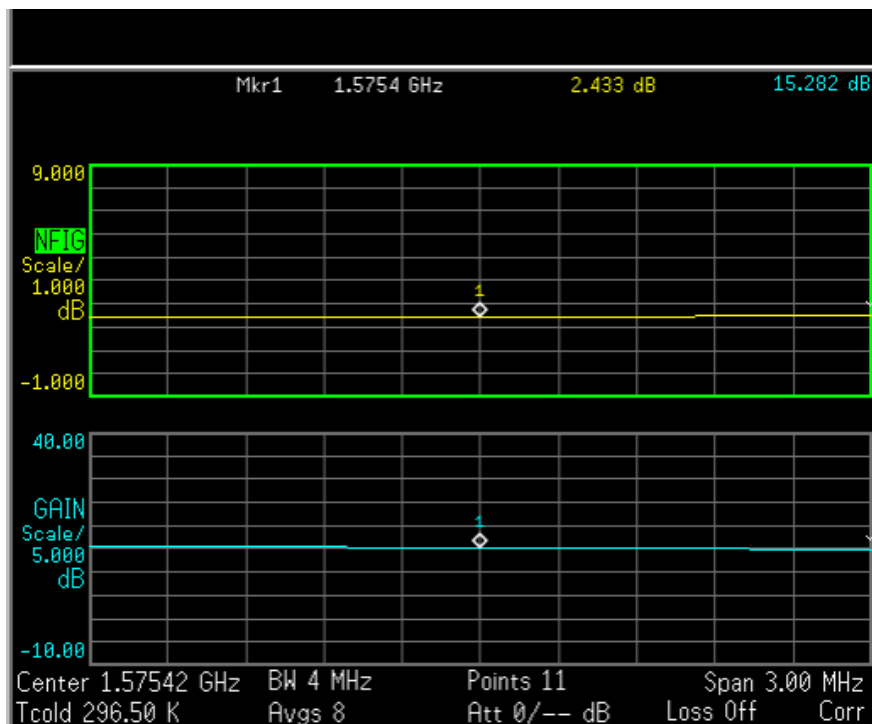

### 4. LNA Noise Figure @3.0V

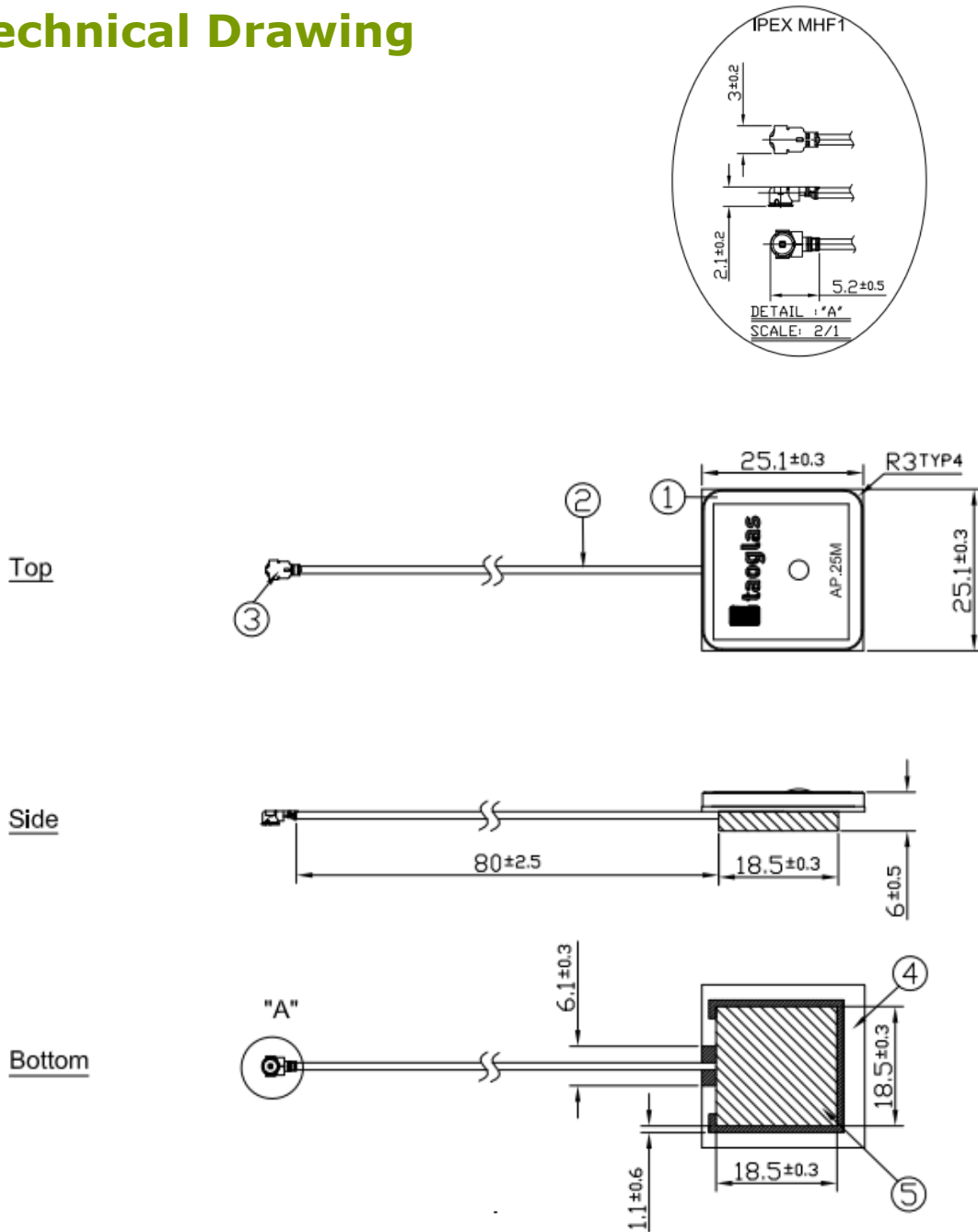

## 5. Technical Drawing



NOTE:  
 1.Soldered area   
 2.Shielding case area   
 3.All material must be RoHS compliant.  
 4.The connector orientation has a fixed position to the antenna as per drawing.

	Name	P/N	Material	Finish	QTY
1	AP.25M Patch(25*25*2mm)	001513A030007A	Ceramic	Clear	1
2	1.13 Cable	300113A000007A	PVC	Gray	1
3	IPEX MHF1	204111G000007A	Brass	Gold	1
4	PCB	100213A020007A	Composite	Green	1
5	Shielding Case	000513A010007A	(TIn)SPTE	TIn Plated	1

## 6. Radiation Patterns

XY Plane

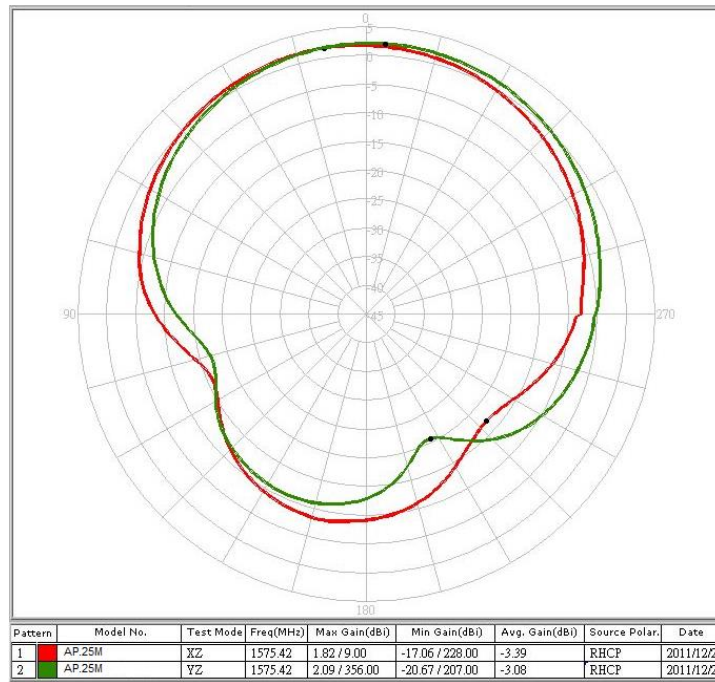

XZ Plane

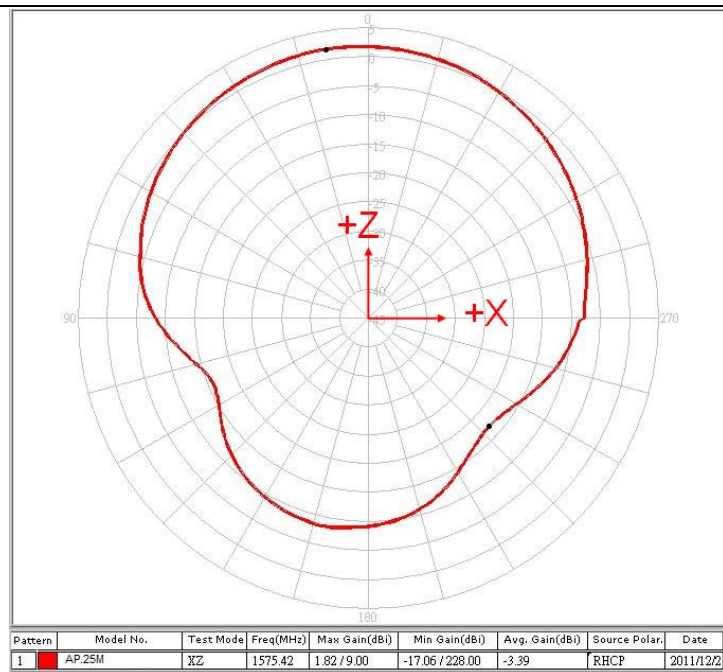

YZ Plane

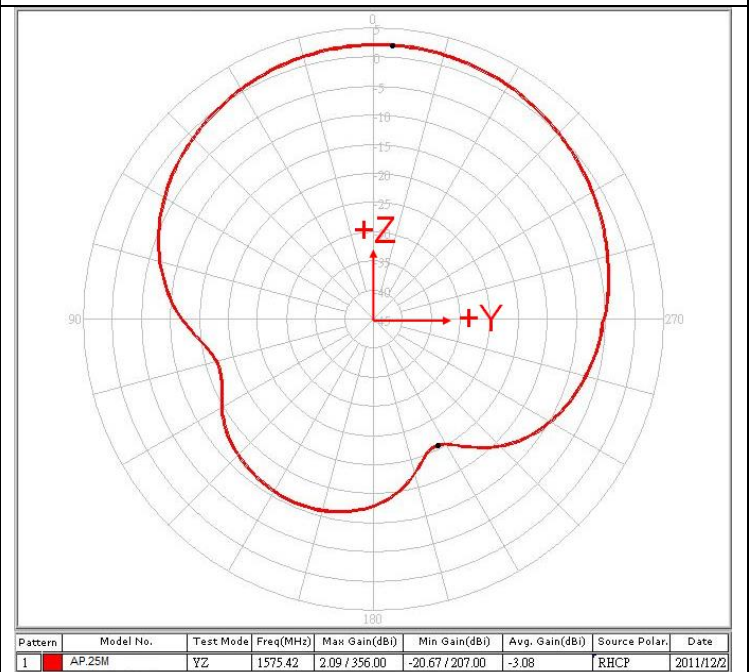

## 7. Plugs Usage Precautions

### 7.1. Mating / unmating

(1) To disconnect connectors, insert the end portion of I-PEX under the connector flanges and pull off vertically, in the direction of the connector mating axis.

(2) To mate the connectors, the mating axes of both connectors must be aligned and the connectors can be mated. The "click" will confirm fully mated connection. Do not attempt to insert on an extreme angle.

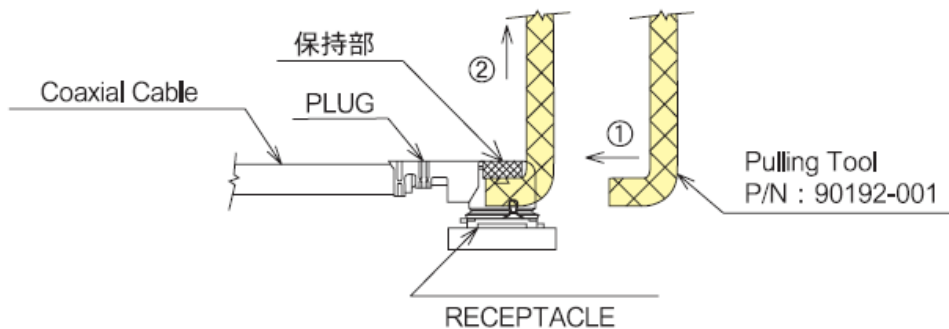

### 7.2. Pull forces on the cable after connectors are mated

After the connectors are mated, do not apply a load to the cable in excess of the values indicated in the diagram below.

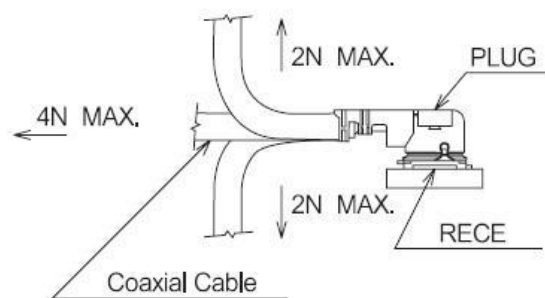



## 8. Packaging

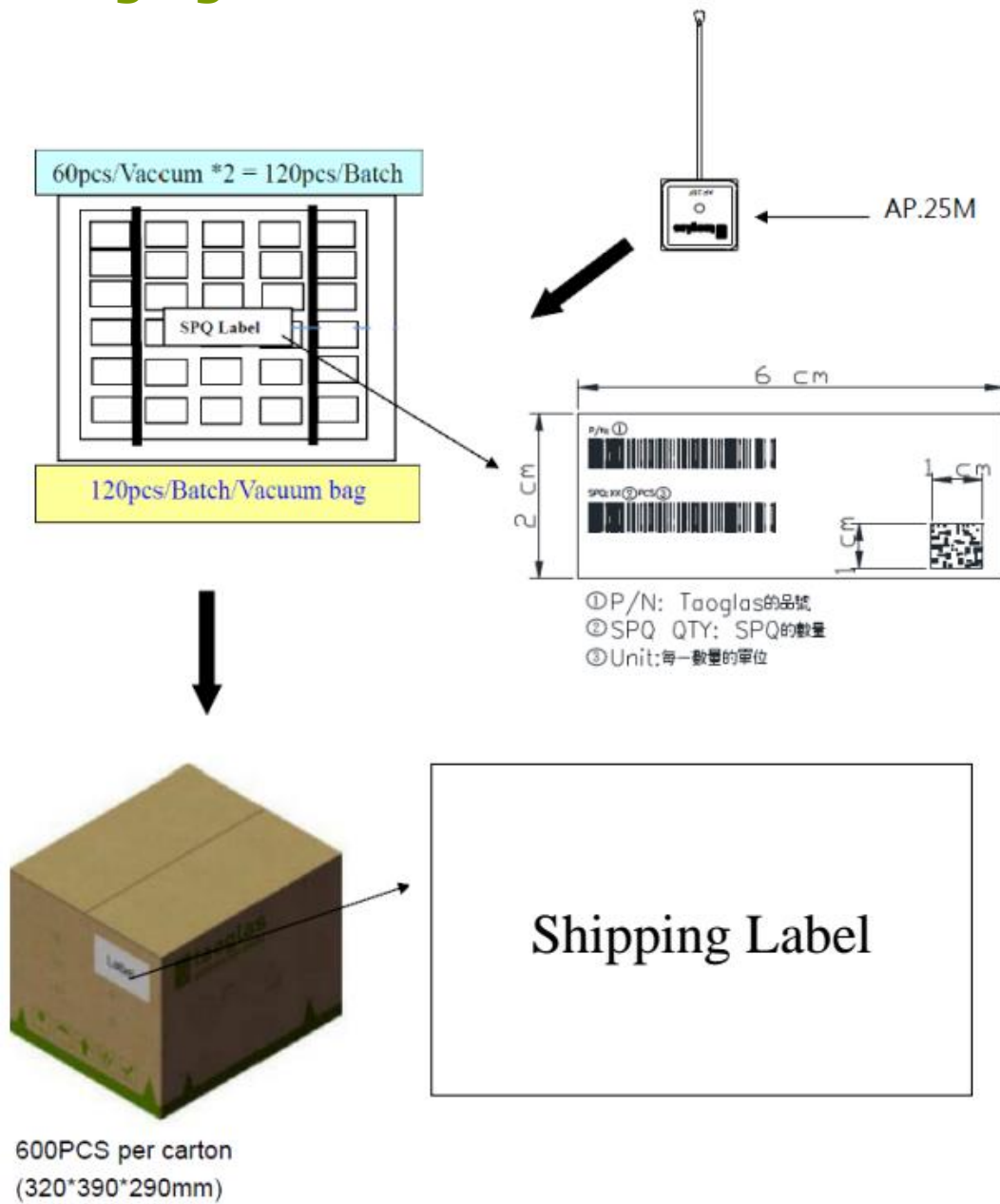

Taoglas makes no warranties based on the accuracy or completeness of the contents of this document and reserves the right to make changes to specifications and product descriptions at any time without notice.

Taoglas reserves the rights to this document and the information contained herein. Reproduction, use or disclosure to third parties without express permission is strictly prohibited.

Copyright © Taoglas Ltd.

## X-ON Electronics

Largest Supplier of Electrical and Electronic Components

*Click to view similar products for [Antennas](#) category:*

*Click to view products by [Taoglas](#) manufacturer:*

Other Similar products are found below :

[GAN30084EU](#) [930-033-R](#) [GW17.07.0250E](#) [1513563-1](#) [EXE902SM](#) [APAMPG-117](#) [MAF94383](#) [W3908B0100](#) [W6102B0100](#) [YE572113-30RSMM](#) [108-00014-50](#) [66089-2406](#) [SPDA17RP918](#) [A09-F8NF-M](#) [A09-F5NF-M](#) [RGFRA1903041A1T](#) [W3593B0100](#) [W3921B0100](#) [SIMNA-868](#) [SIMNA-915](#) [SIMNA-433](#) [W1044](#) [W1049B090](#) [A75-001](#) [WTL2449CQ1-FRSMM](#) [CPL9C](#) [EXB148BN](#) [0600-00060](#) [TRA9020S3PBN-001](#) [Y4503](#) [GD5W-28P-NF](#) [MA9-7N](#) [GD53-25](#) [GD5W-21P-NF](#) [C37](#) [MAF94051](#) [MA9-5N](#) [EXD420PL](#) [B1322NR](#) [QWFTB120](#) [MAF94271](#) [MAF94300](#) [GPSMB301](#) [FG4403](#) [AO-AGSM-OM54](#) [5200232](#) [MIKROE-2349](#) [WCM.01.0111](#) [MIKROE-2393](#) [MIKROE-2352](#)