

## SPECIFICATION

- Part No. : **CA.50**
- Product Name : 5150-5900 MHz Ceramic Chip Monopole  
Antenna  
Wi-Fi/ WHDMI / 5GHz ISM Band
- Feature : 3.2mm \*1.6mm \* 0.5mm  
Low profile  
Peak gain 3.4 dBi  
Compact Size  
**RoHS Compliant**

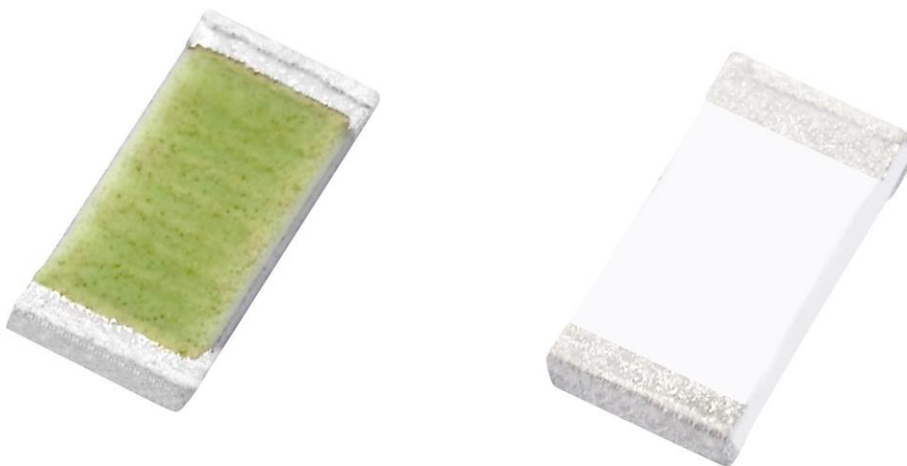

## 1. Introduction

Taoglas' 5150-5900 MHz ceramic chip antenna is specifically designed for Wi-Fi/ WHDMI/ High Bandwidth 5GHz band applications. It is a high efficiency miniature SMD edge mounted ceramic monopole antenna with small footprint requirement. This ceramic chip antenna uses the main PCB as its ground plane, thereby increasing antenna efficiency. It is tuned for different PCB sizes by simply changing the value of the matching circuit. CA.50 antenna electrical properties are symmetrical therefore the antenna can be soldered to the board from either side. At 3.2mm\*1.6mm\*0.5mm, it is one of the smallest antennas available worldwide. This antenna is delivered on tape and reel.

Many module manufacturers specify peak gain limits for any antennas that are to be connected to that module. Those peak gain limits are based on free-space conditions. In practice, the peak gain of an antenna tested in free-space can degrade by at least 1 or 2dBi when put inside a device. So ideally you should go for a slightly higher peak gain antenna than mentioned on the module specification to compensate for this effect, giving you better performance.

Upon testing of any of our antennas with your device and a selection of appropriate layout, integration technique, or cable, Taoglas can make sure any of our antennas' peak gain will be below the peak gain limits. Taoglas can then issue a specification and/or report for the selected antenna in your device that will clearly show it complying with the peak gain limits, so you can be assured you are meeting regulatory requirements for that module.

For example, a module manufacturer may state that the antenna must have less than 2dBi peak gain, but you don't need to select an embedded antenna

that has a peak gain of less than 2dBi in free-space. This will give you a less optimized solution. It is better to go for a slightly higher free-space peak gain of 3dBi or more if available. Once that antenna gets integrated into your device, performance will degrade below this 2dBi peak gain due to the effects of GND plane, surrounding components, and device housing. If you want to be absolutely sure, contact Taoglas and we will test. Choosing a Taoglas antenna with a higher peak gain than what is specified by the module manufacturer and enlisting our help will ensure you are getting the best performance possible without exceeding the peak gain limits.

## **Applications**

IEEE802.11a (5150-5900 MHz)

WHDMI PCMCIA cards, USB dongles, High Bandwidth Video Transmission

## 2. Specification Table

Electrical	
Center Frequency (MHz)	5500
Bandwidth (MHz)	750 min.
Peak Gain (dBi)	3.4 (typical)
Efficiency (%)	79 (typical)
VSWR	2 max.
Impedance ( $\Omega$ )	50 $\Omega$
Polarization	Linear
Radiation Pattern	Omni
Input Power(W)	50
MECHANICAL	
Dimensions (mm)	3.2 x 1.6 x 0.5
Ground plane (mm)	40x40
Material	AS 6
ENVIRONMENTAL	
Temperature Range	-40°C to 85°C
Temperature Coefficient of Frequency (ppm/°C)	0 $\pm$ 20 max. (@-40°C to 85°C)
Humidity	Non-condensing 65°C 95% RH

### 3. Return Loss

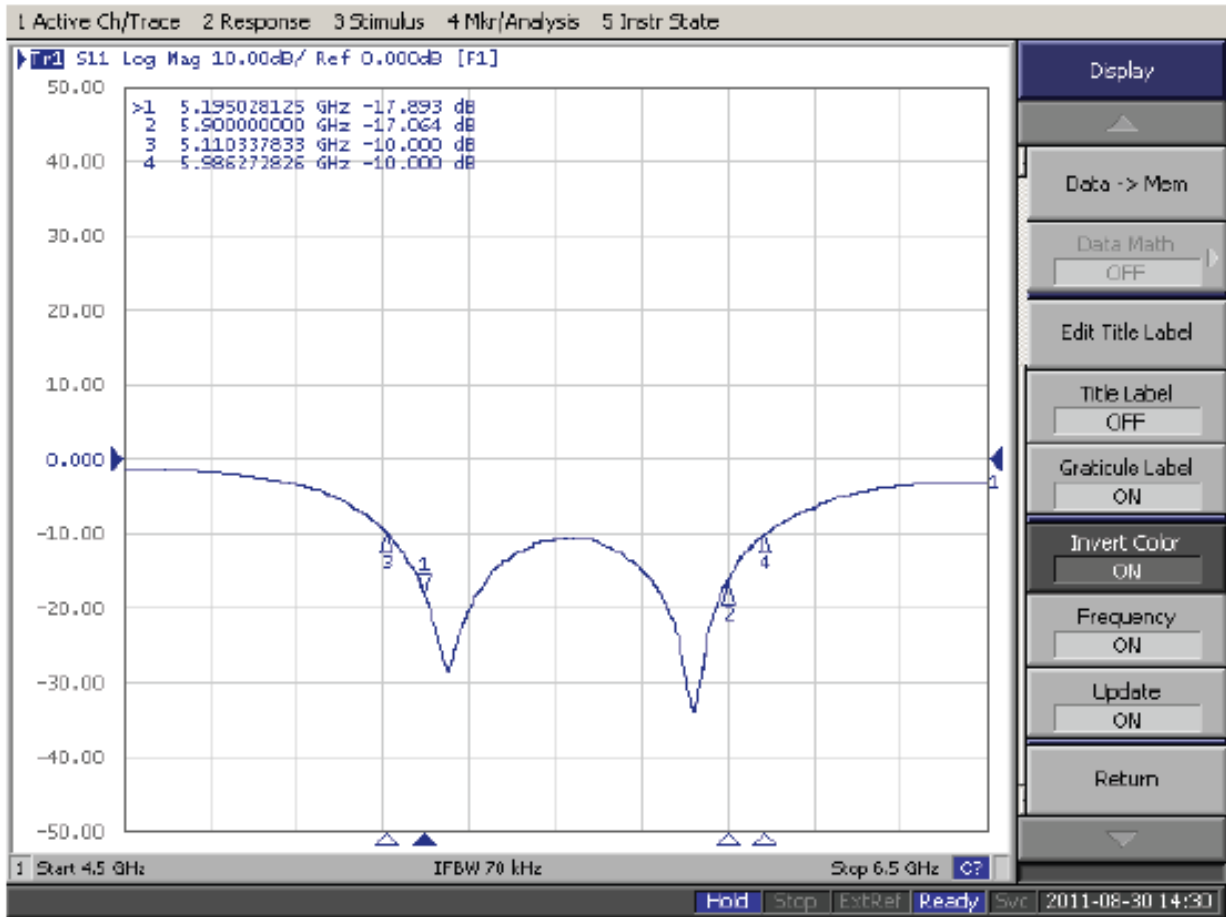

## 4. Smith Chart

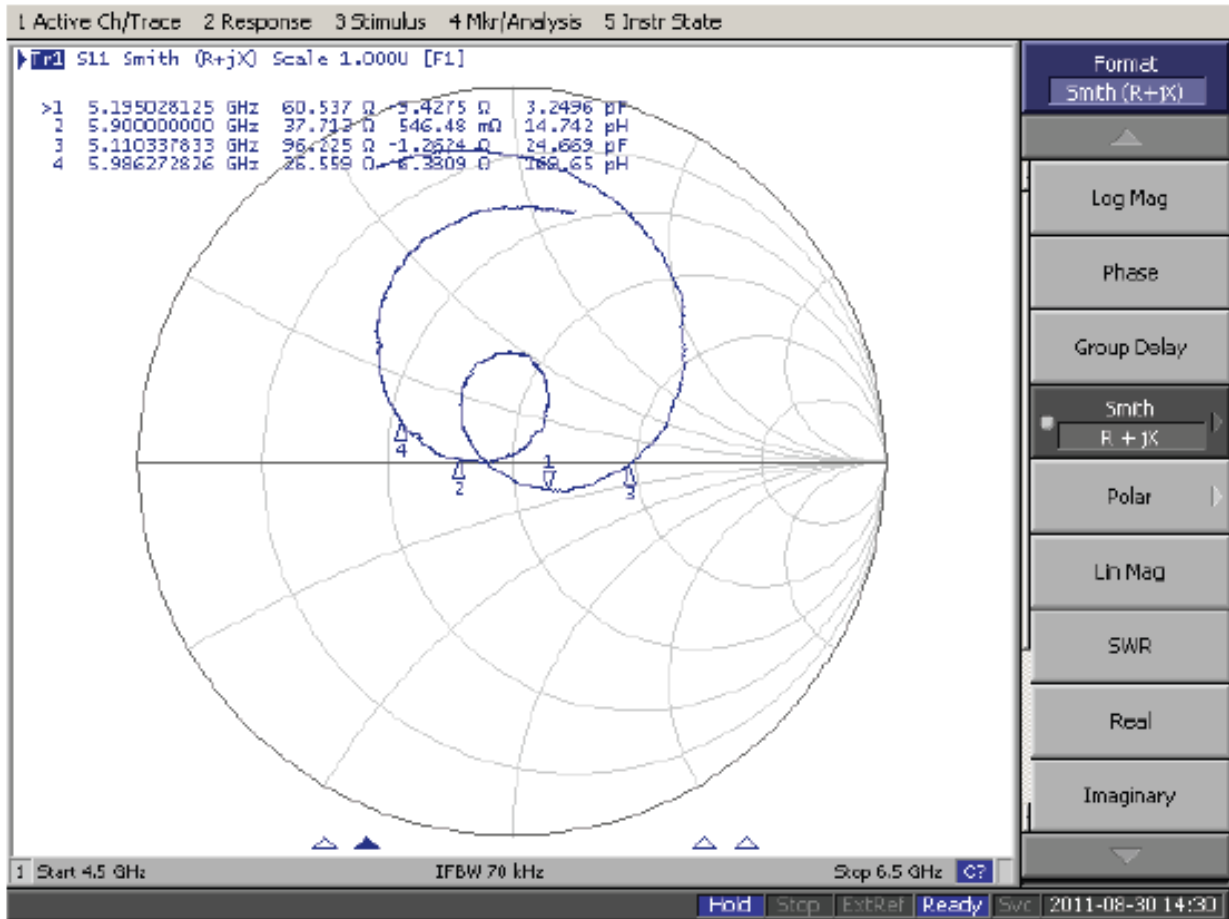

## 5. Efficiency

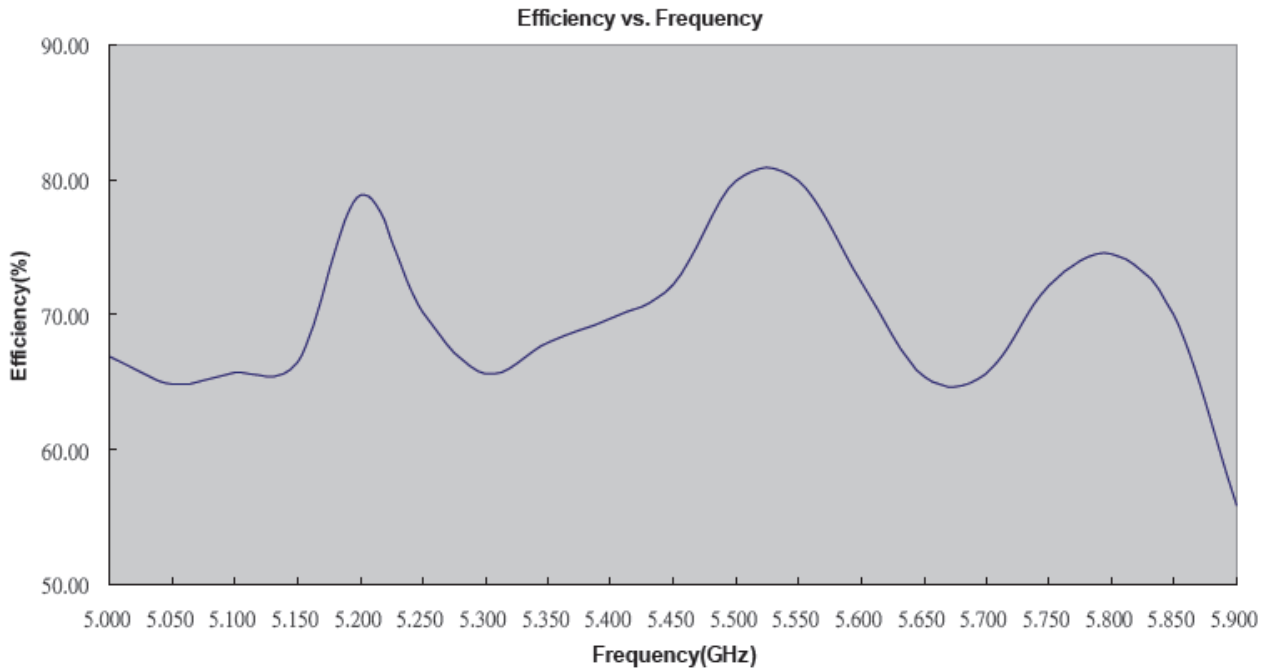

<b>Frequency(GHz)</b>	<b>5.000</b>	<b>5.050</b>	<b>5.100</b>	<b>5.150</b>	<b>5.200</b>	<b>5.250</b>	<b>5.300</b>	<b>5.350</b>	<b>5.400</b>	<b>5.450</b>
Efficiency(dB)	-1.75	-1.88	-1.82	-1.77	-1.03	-1.54	-1.83	-1.68	-1.57	-1.41
Efficiency(%)	66.83	64.86	65.75	66.53	78.89	70.15	65.61	67.92	69.66	72.28
Gain(dBi)	2.66	2.22	2.00	2.76	3.22	2.56	2.25	2.53	2.77	3.45

<b>Frequency(GHz)</b>	<b>5.500</b>	<b>5.550</b>	<b>5.600</b>	<b>5.650</b>	<b>5.700</b>	<b>5.750</b>	<b>5.800</b>	<b>5.850</b>	<b>5.900</b>
Efficiency(dB)	-0.97	-0.97	-1.40	-1.84	-1.83	-1.42	-1.28	-1.55	-2.53
Efficiency(%)	79.98	79.98	72.44	65.46	65.61	72.11	74.47	69.98	55.85
Gain(dBi)	3.42	3.35	3.14	2.80	2.86	3.28	3.59	3.40	2.56

## 6. Antenna Radiation Patterns

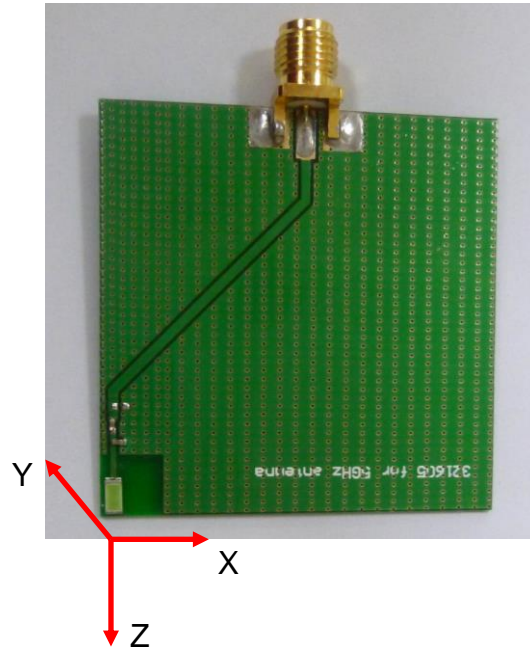

### 6.1 3D Gain pattern @ 5150 MHz

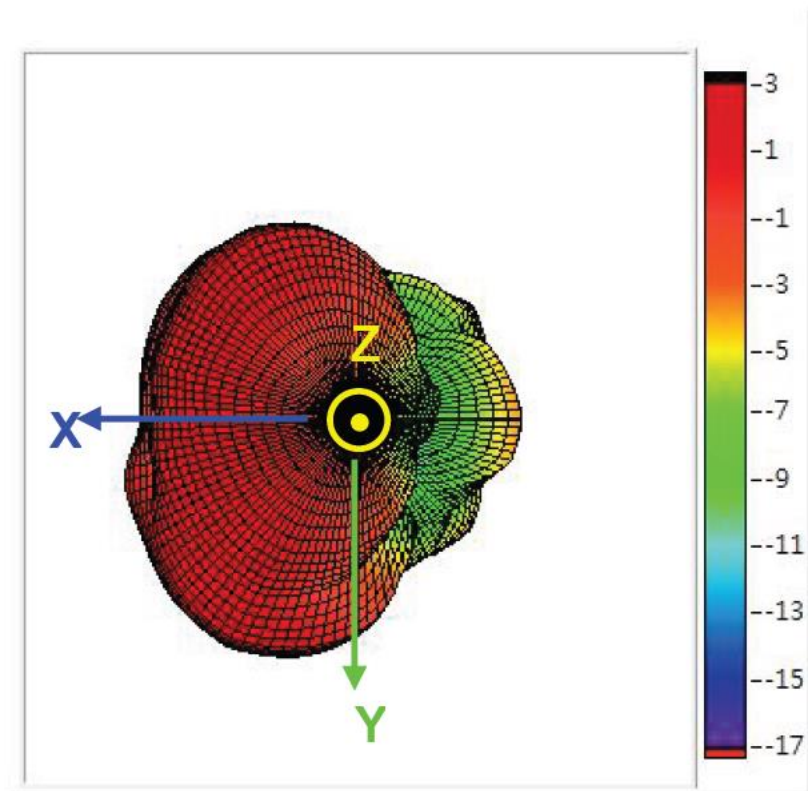



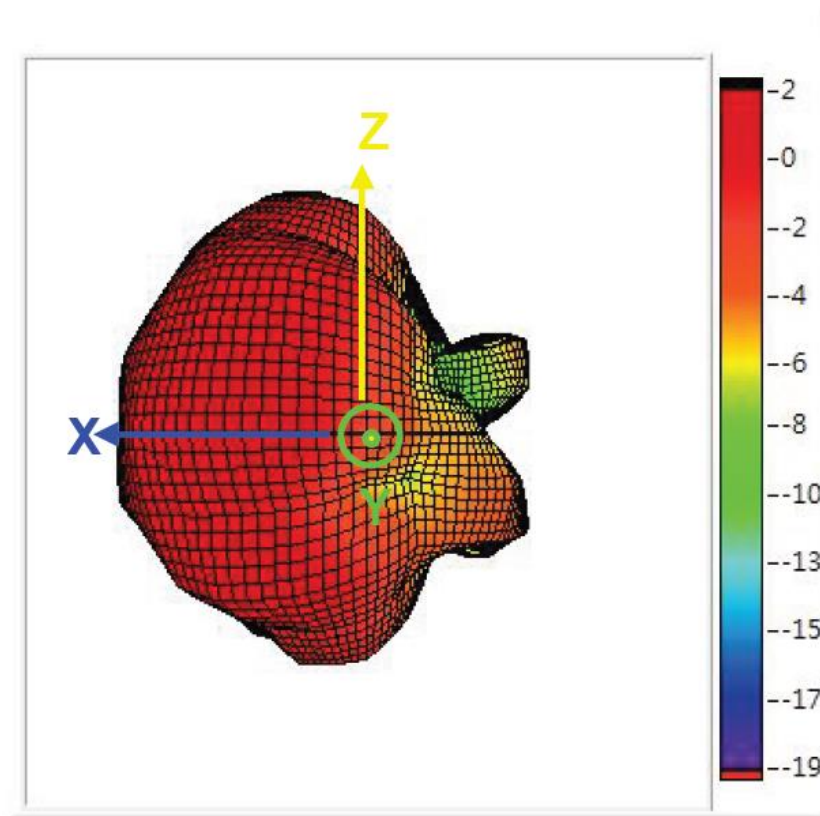
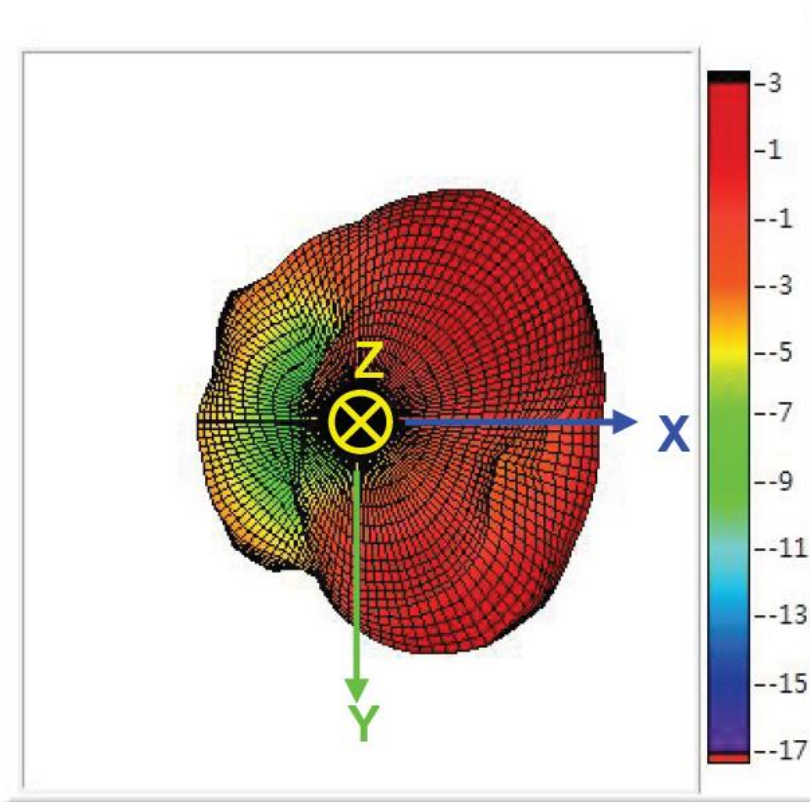

### 6.2 3D Gain pattern @ 5350 MHz

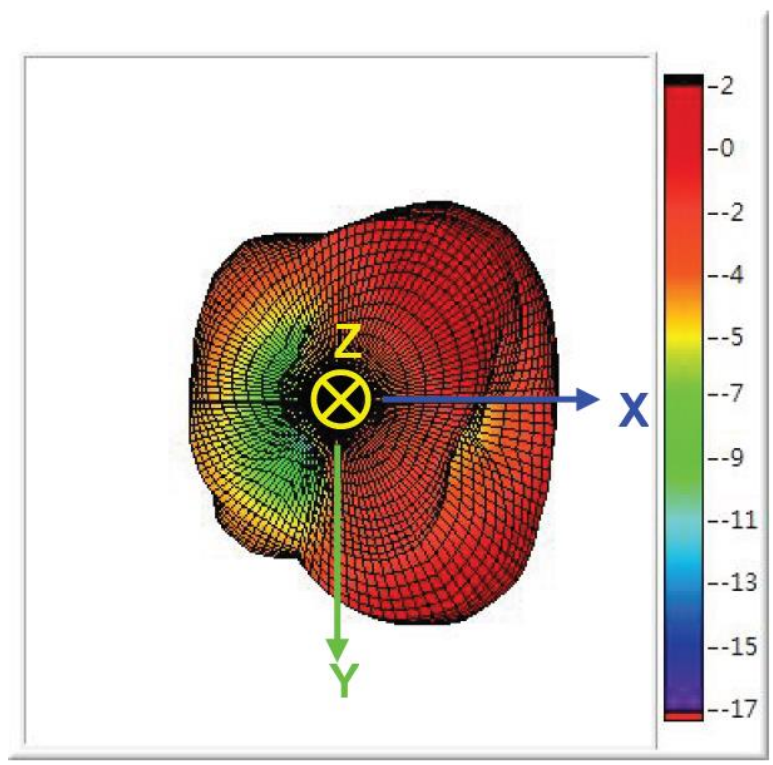
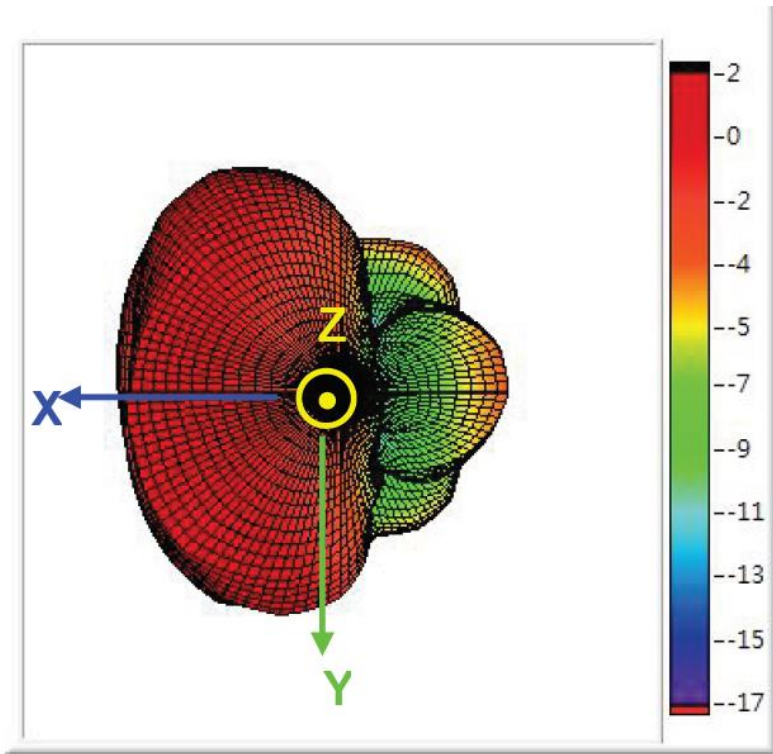

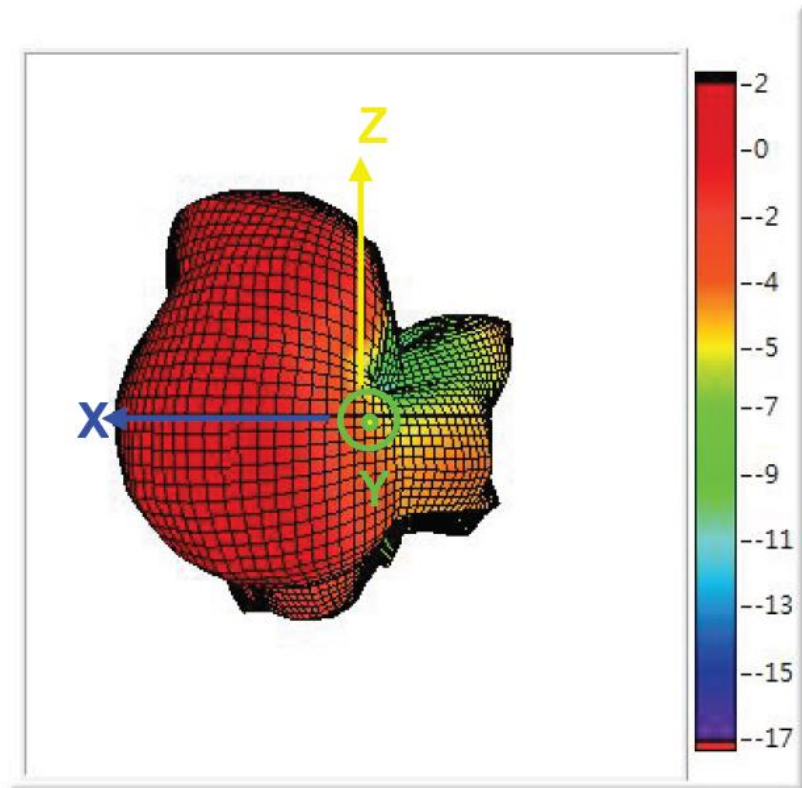

**6.3 3D Gain pattern @ 5700 MHz**

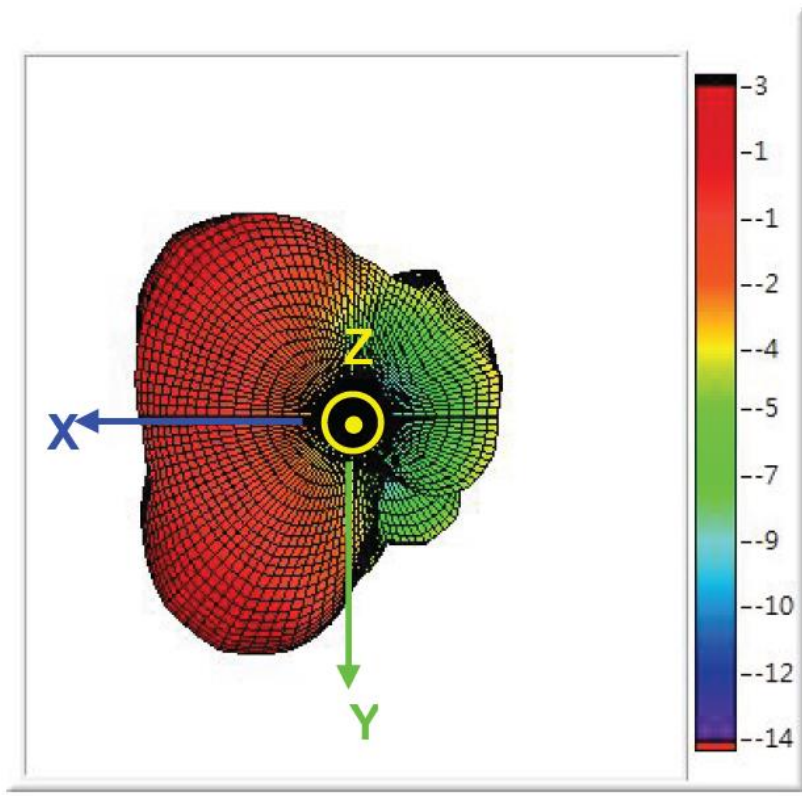

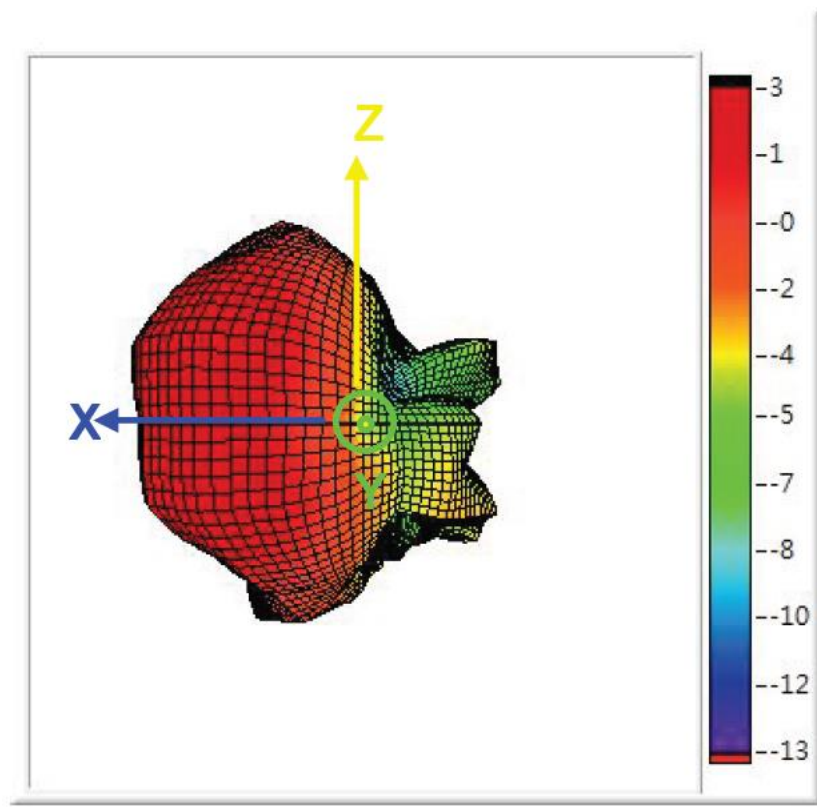
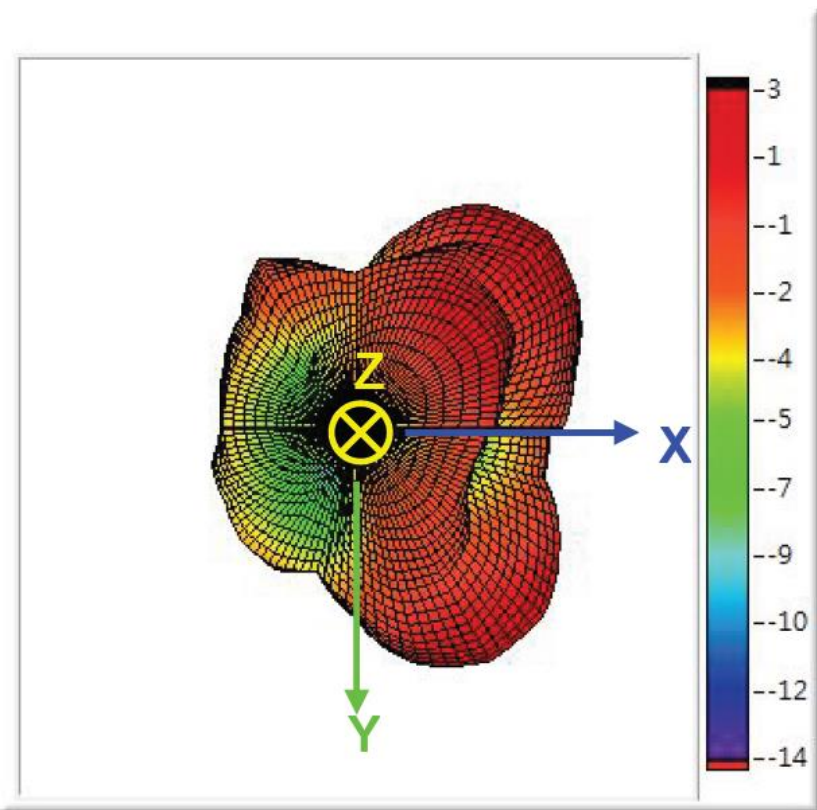

### 6.4 3D Gain pattern @ 5850 MHz

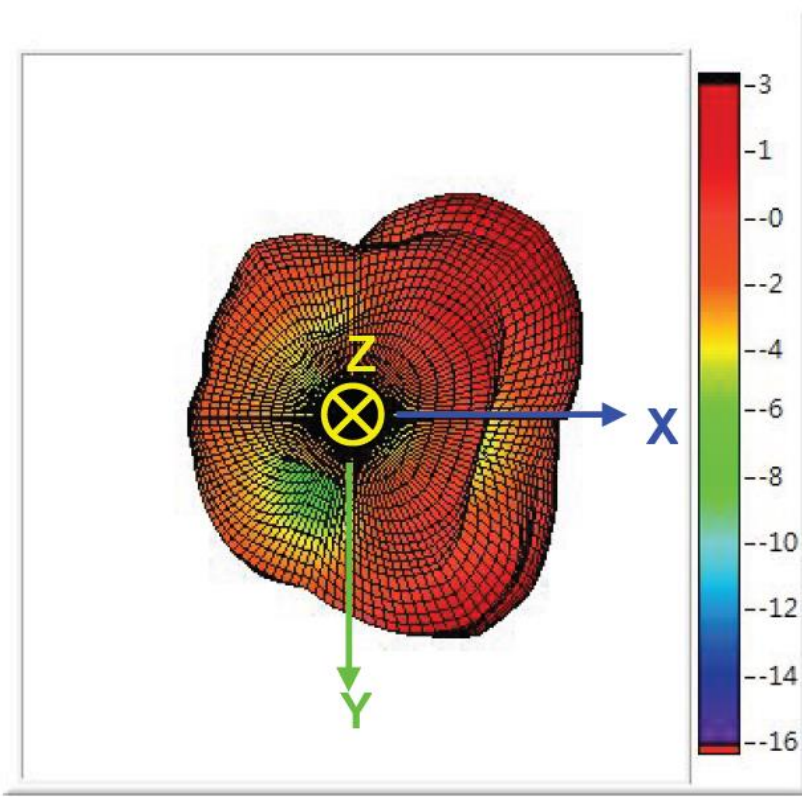
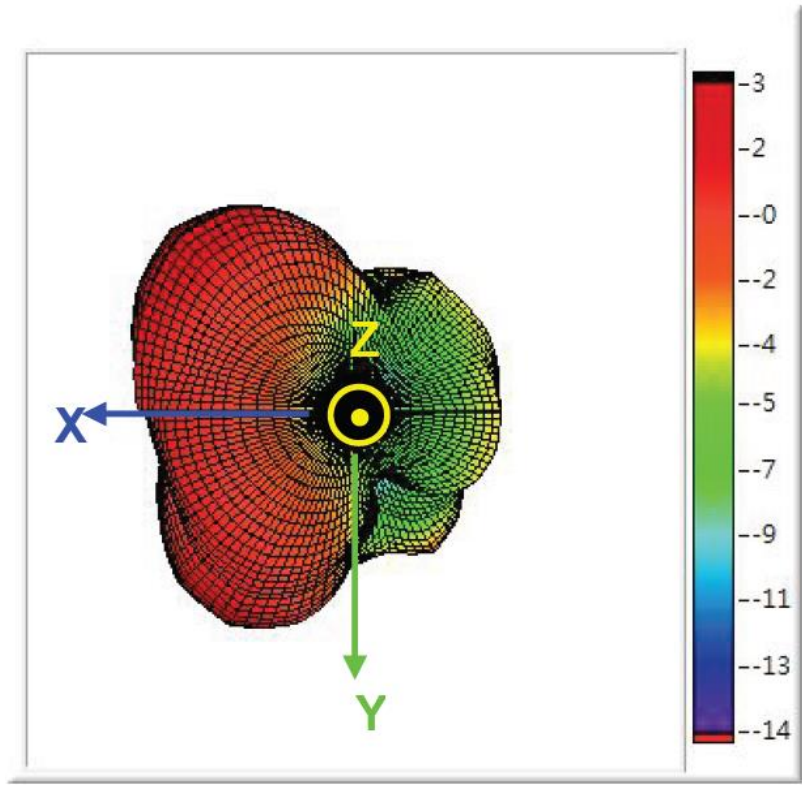

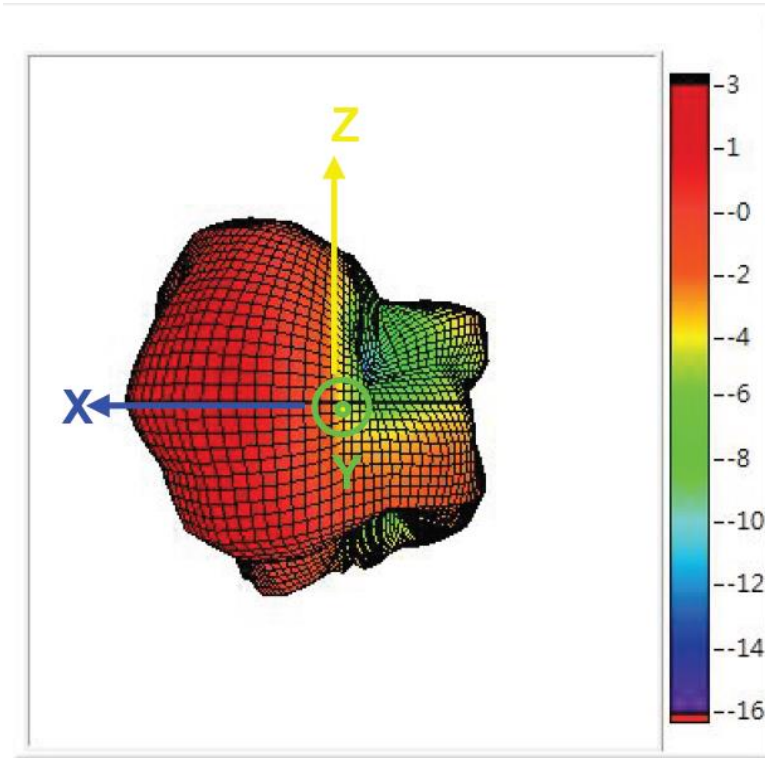

# 7. Mechanical Drawing

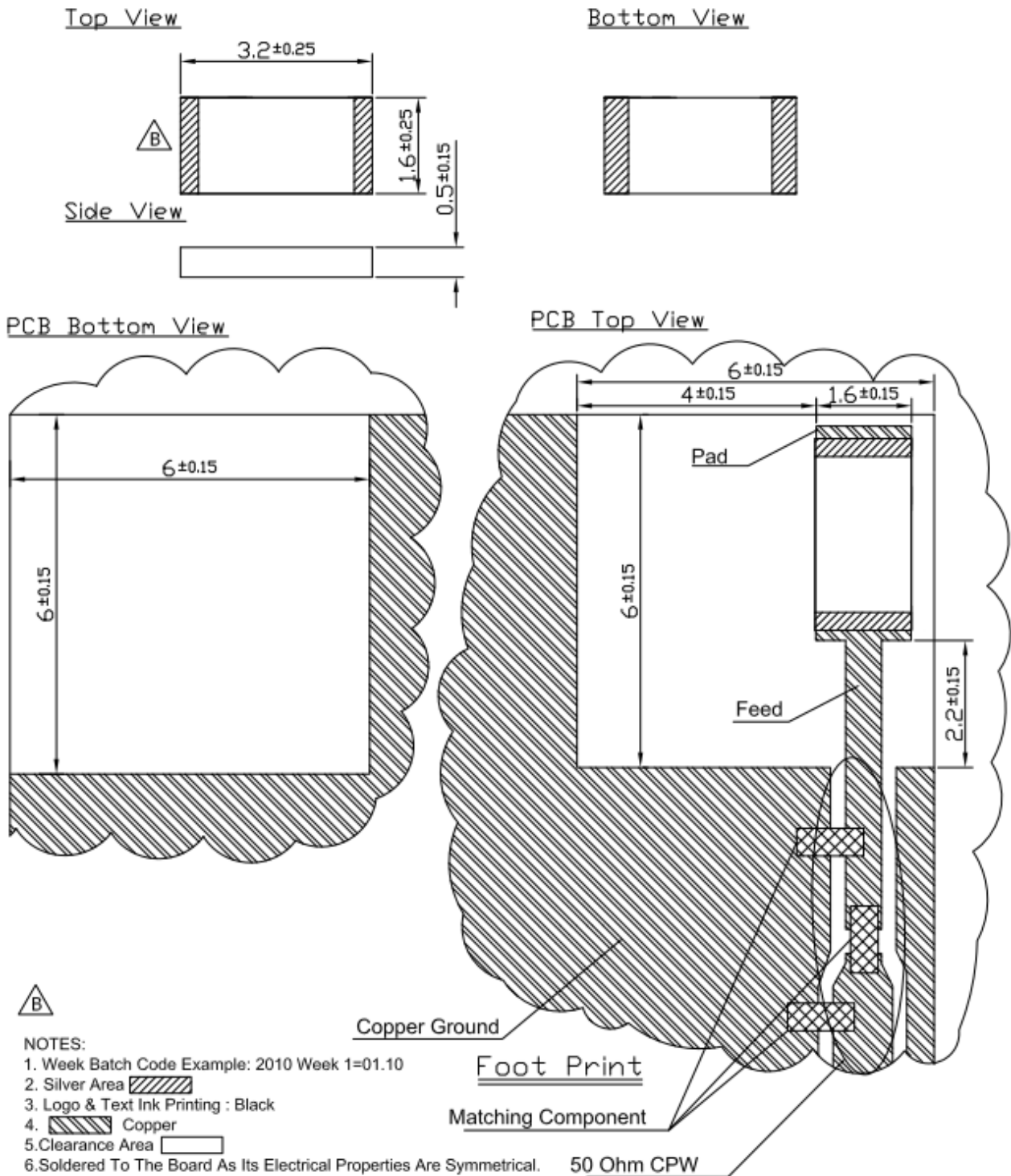

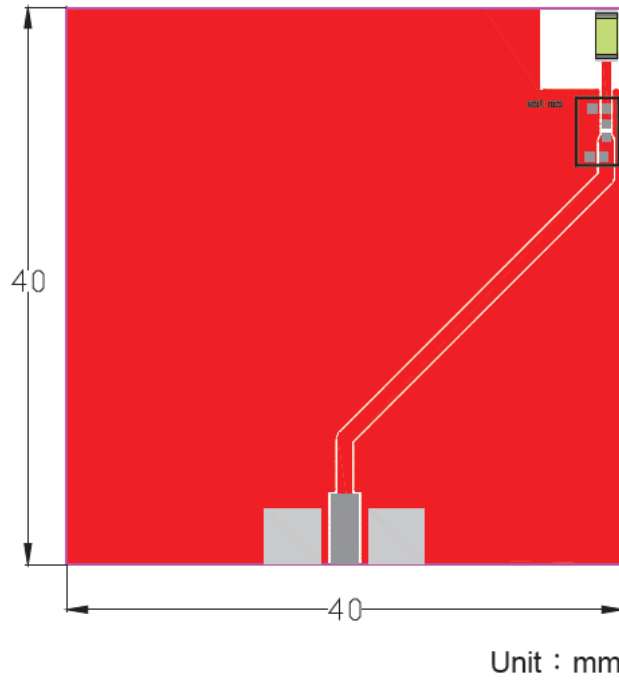



## 8. Layout Guide

Solder Land Pattern:

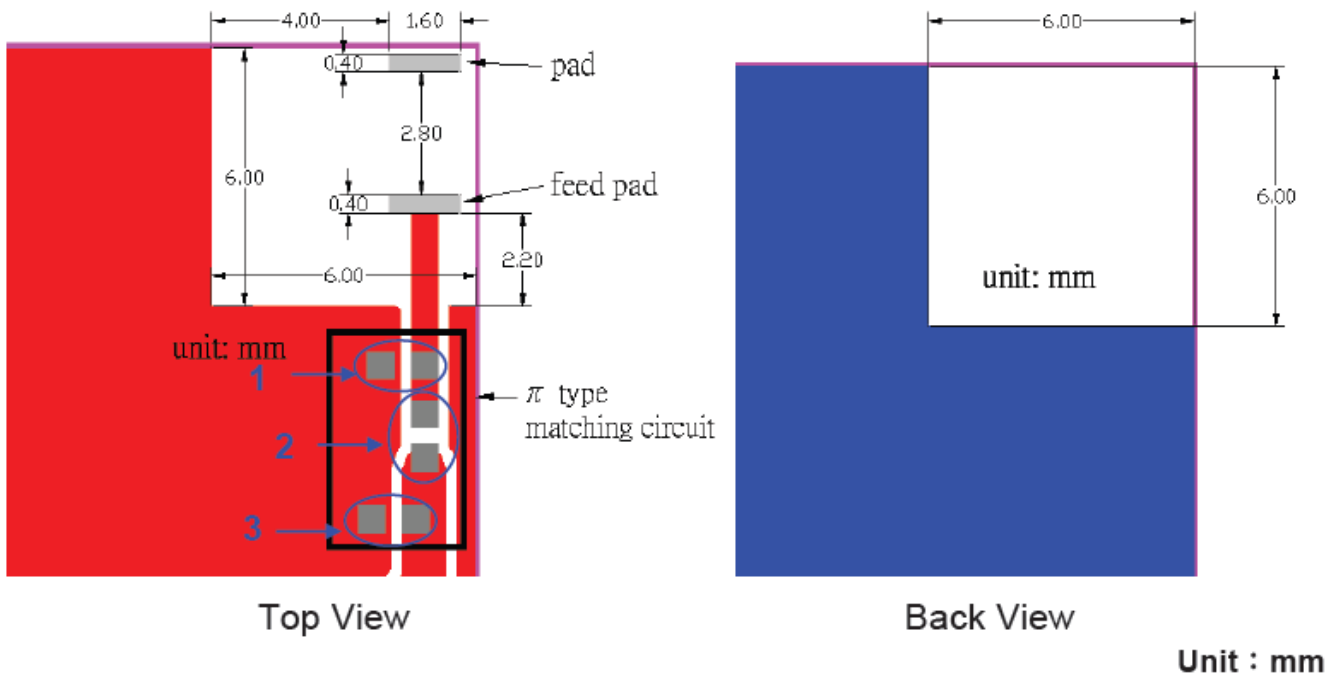

Matching circuit: (Center frequency is 5500MHz at 40x40mm ground plane)

Antenna

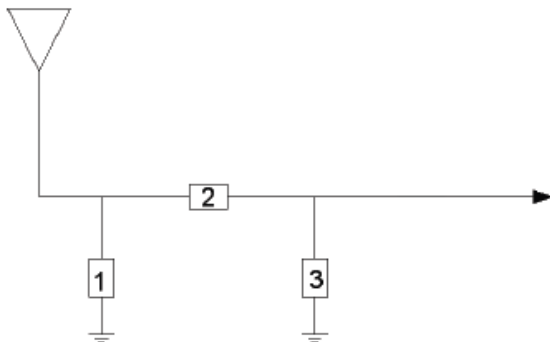

System Matching Circuit Component		
Location	Description	Vendor
1	0.3pF	DARFNO(0402)
2	4.7pF	DARFNO(0402)
3	0.47pF	DARFNO(0402)

## 9. Soldering Conditions

Typical Soldering profile for lead-free process:

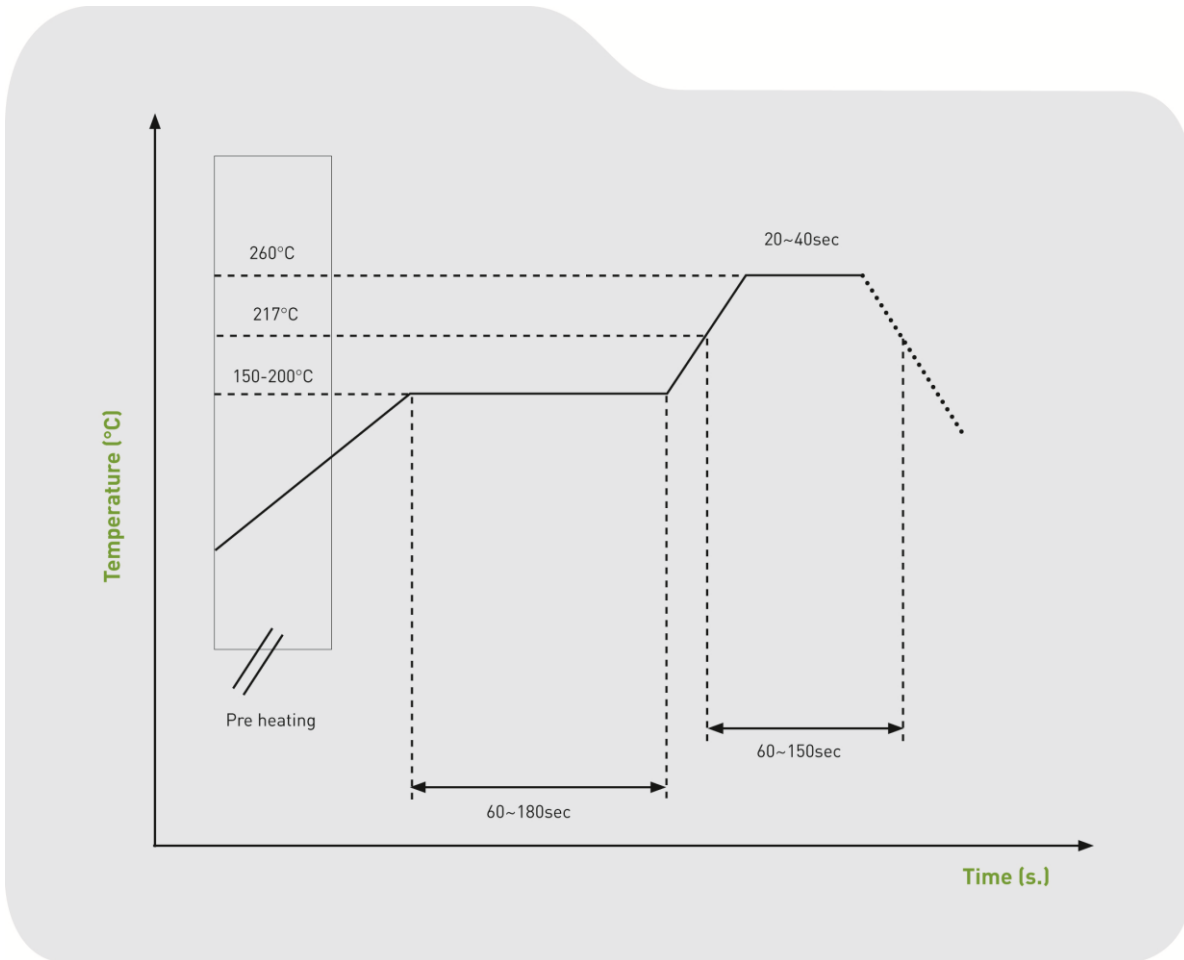

# 10. Packing

Quantity: 1000pcs/ Reel

H: Reel Height =

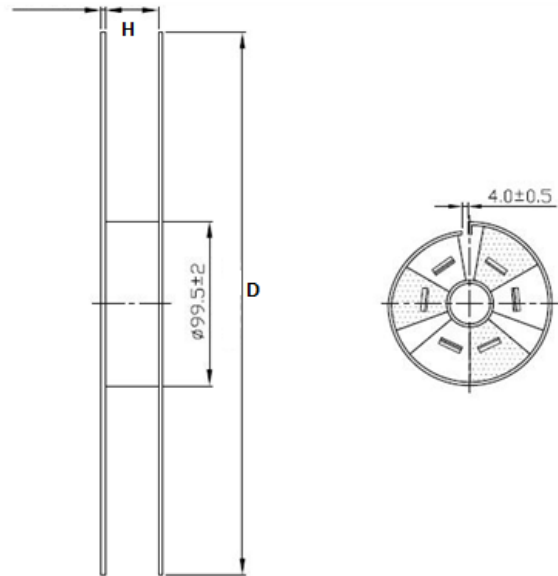
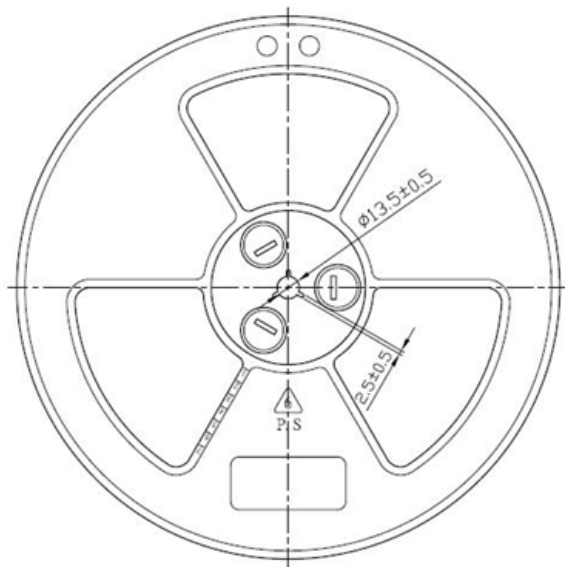

## X-ON Electronics

Largest Supplier of Electrical and Electronic Components

*Click to view similar products for [Antennas](#) category:*

*Click to view products by [Taoglas](#) manufacturer:*

Other Similar products are found below :

[GAN30084EU](#) [930-033-R](#) [GW17.07.0250E](#) [1513563-1](#) [EXE902SM](#) [APAMPG-117](#) [MAF94383](#) [W3908B0100](#) [W6102B0100](#) [YE572113-30RSMM](#) [108-00014-50](#) [66089-2406](#) [SPDA17RP918](#) [A09-F8NF-M](#) [A09-F5NF-M](#) [RGFRA1903041A1T](#) [W3593B0100](#) [W3921B0100](#) [SIMNA-868](#) [SIMNA-915](#) [SIMNA-433](#) [W1044](#) [W1049B090](#) [A75-001](#) [WTL2449CQ1-FRSMM](#) [CPL9C](#) [EXB148BN](#) [0600-00060](#) [TRA9020S3PBN-001](#) [GD5W-28P-NF](#) [MA9-7N](#) [GD53-25](#) [GD5W-21P-NF](#) [C37](#) [MAF94051](#) [MA9-5N](#) [EXD420PL](#) [B1322NR](#) [QWFTB120](#) [MAF94271](#) [MAF94300](#) [GPSMB301](#) [FG4403](#) [AO-AGSM-OM54](#) [5200232](#) [MIKROE-2349](#) [WCM.01.0111](#) [MIKROE-2393](#) [MIKROE-2352](#) [MIKROE-2350](#)