

SPECIFICATION

- Part No. : **FXP07.07.0100A**
- Product Name : Flexible PCB Penta Band GSM Antenna,
100mm Ø1.13 cable, IPEX connector
- Feature : Very low profile Penta band GSM
Adhesive tape for easy mounting
RoHS compliant

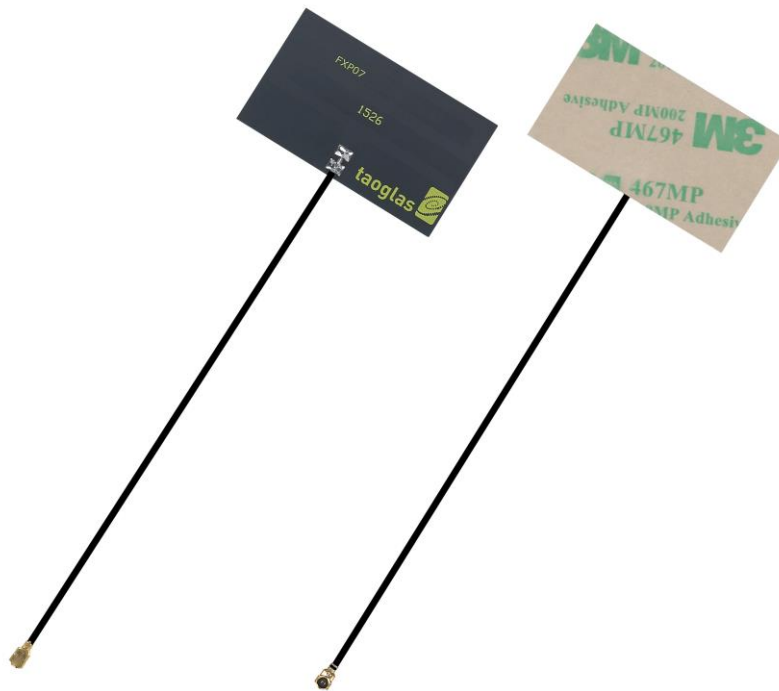

1. Introduction

FXP07.07.0100A is a general version of stick-on flexible PCB. It is designed with 100mm 1.13mm coaxial cable and the IPEX connector for easy installation. FXP07.07.0100A is ideal for initial test of FPCB type antenna.

2. Specification

| Communication System | Penta-band Cellular | | | | |
|---------------------------|---------------------|---------|-----------|-----------|-----------|
| | AMPS | GSM | DCS | PCS | UMTS |
| Frequency (MHz) | 824 ~ 896 | 880~960 | 1710~1880 | 1850~1990 | 1710~2170 |
| Efficiency (ground plane) | 82% | 82% | 29% | 60% | 49% |
| Efficiency (free space) | 11% | 12% | 41% | 32% | 33% |
| Impedance | 50 Ohm | | | | |
| Radiation Pattern | Omni-directional | | | | |
| Polarization | Linear | | | | |
| FPCB | 41.0 x 24.0 mm | | | | |
| Connector | IPEX | | | | |
| Cable | Ø1.13 | | | | |
| Cable Length | 100 mm | | | | |
| Adhesive Tape | 3M 467 | | | | |
| Operation Temperature | -40°C ~ +85°C | | | | |
| Storage Temperature | -40°C ~ +85°C | | | | |

3. Electrical Property

3.1 Test Setup

FXP.07 was design with a cell phone size ground plane (110 x 45 mm) so works the best with this ground plane. Tests were setup to demonstrate its RF properties with this ground plane, in free space and adhere to a plastic. Satimo SG64 3D-chamber is used for radiation and efficiency test with 5% tolerance.

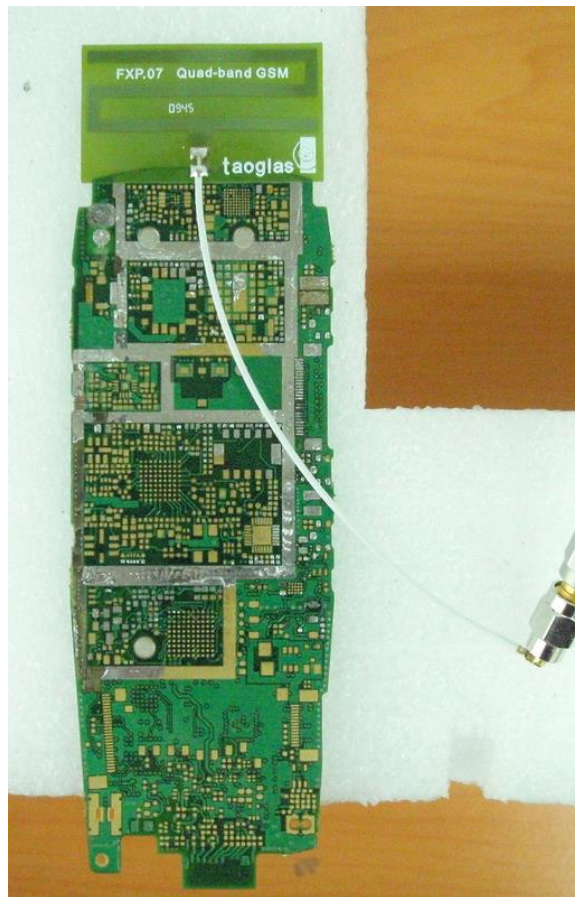

FXP.07 with original ground plane

3.2 Mounting instructions and ground-plane connection



Peel back 3m paper. On the underside of the antenna is automotive grade 3m adhesive (glue) for sticking the FXP.07 directly to plastic (e.g. housing). The antenna can be curved around housing but should not be folded sharply

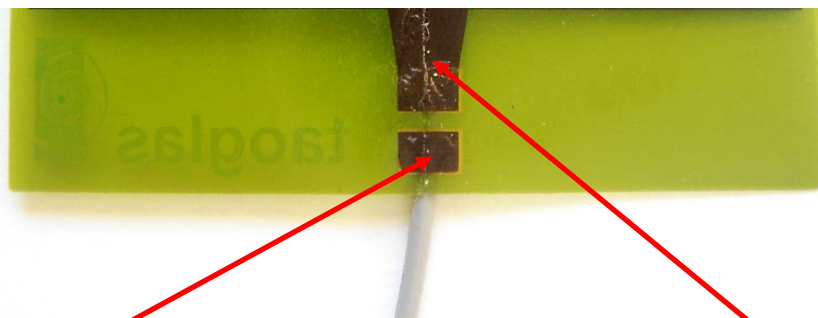

Ground connection - this small square pad at the bottom of the FXP.07 can be seen when paper is removed. This should be connected to extra ground or metal to increase efficiency (e.g. allow pad to touch the side of a PCB like the picture above

This is the antenna trace or signal feed and should be allowed to be free from the PCB and allowed to exist in free area on non metal area (plastic housing)_

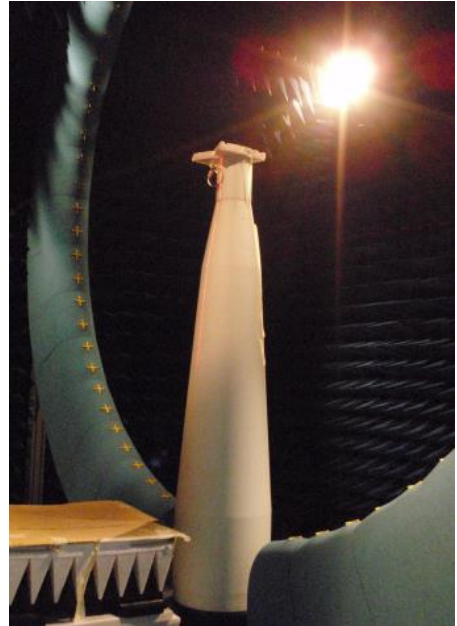
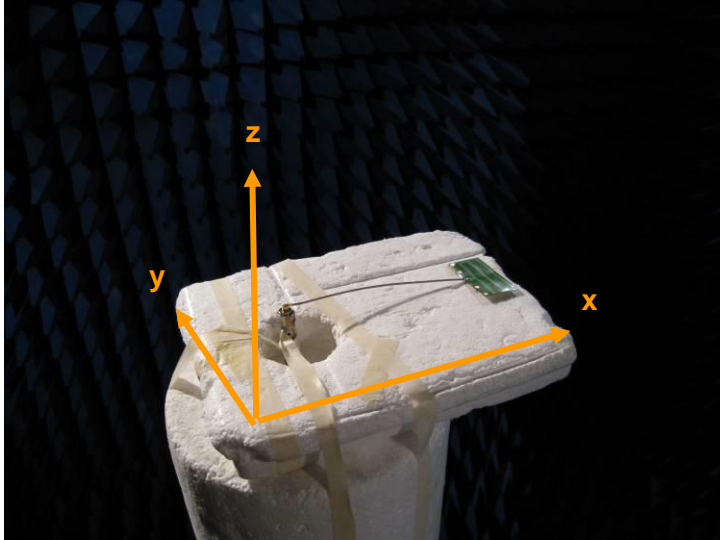

Free space antenna setup and Satimo SG64 3D-chamber.

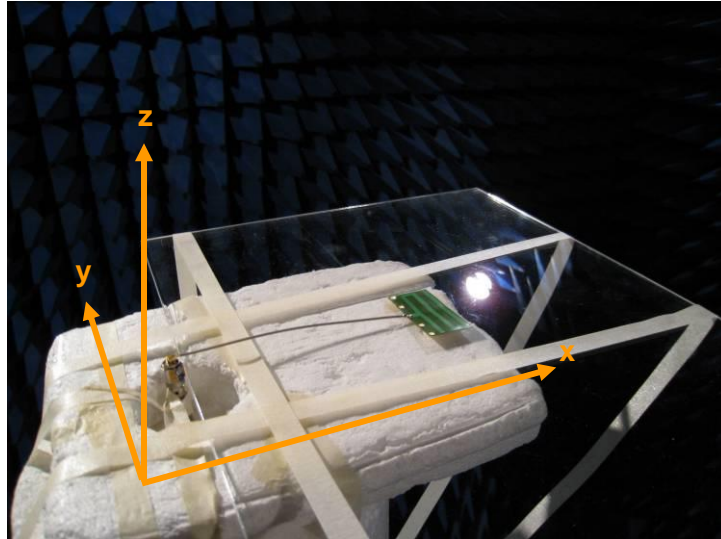

FXP.07 places on a plastic in the chamber.

3.3 Radiation Pattern

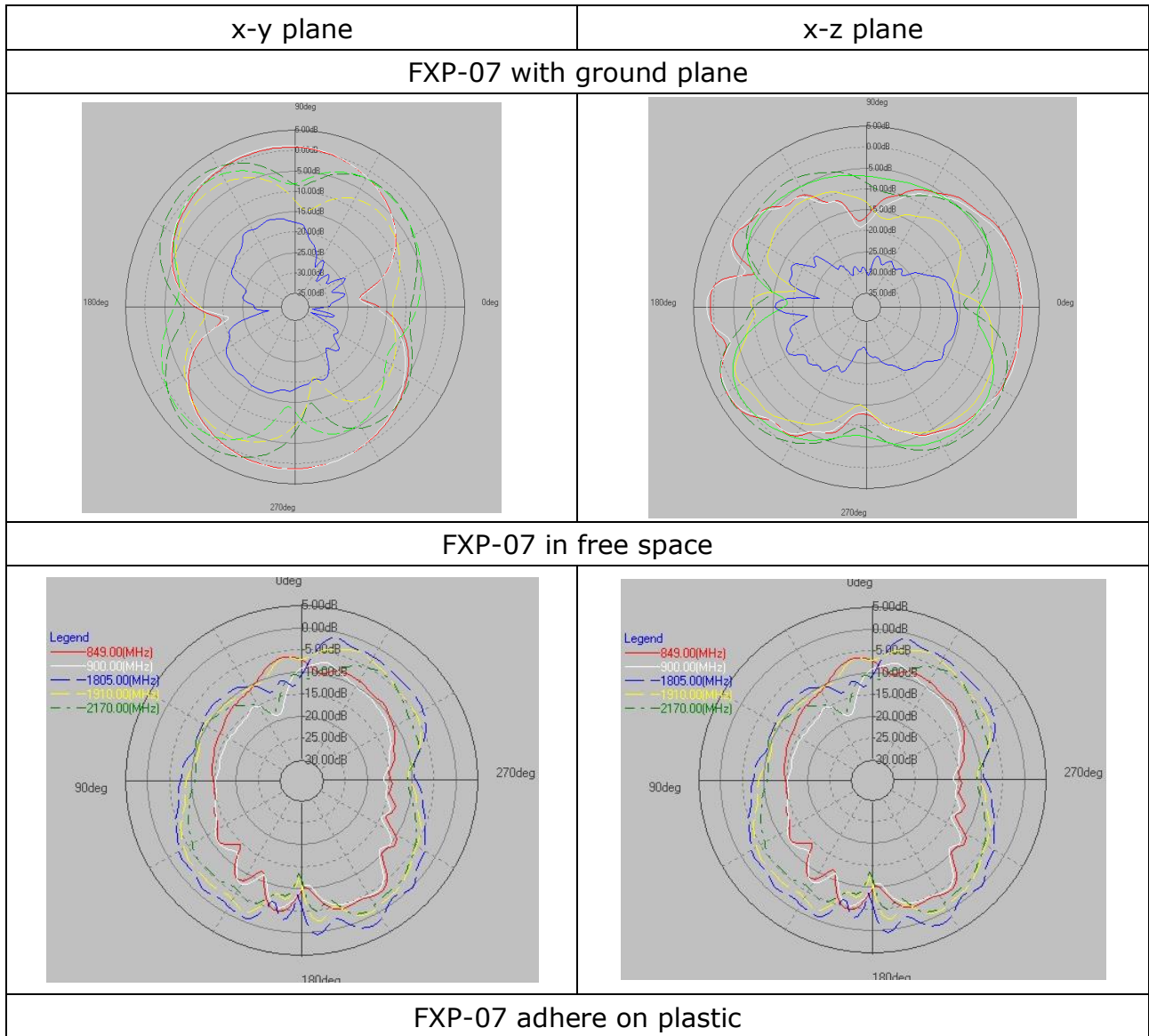

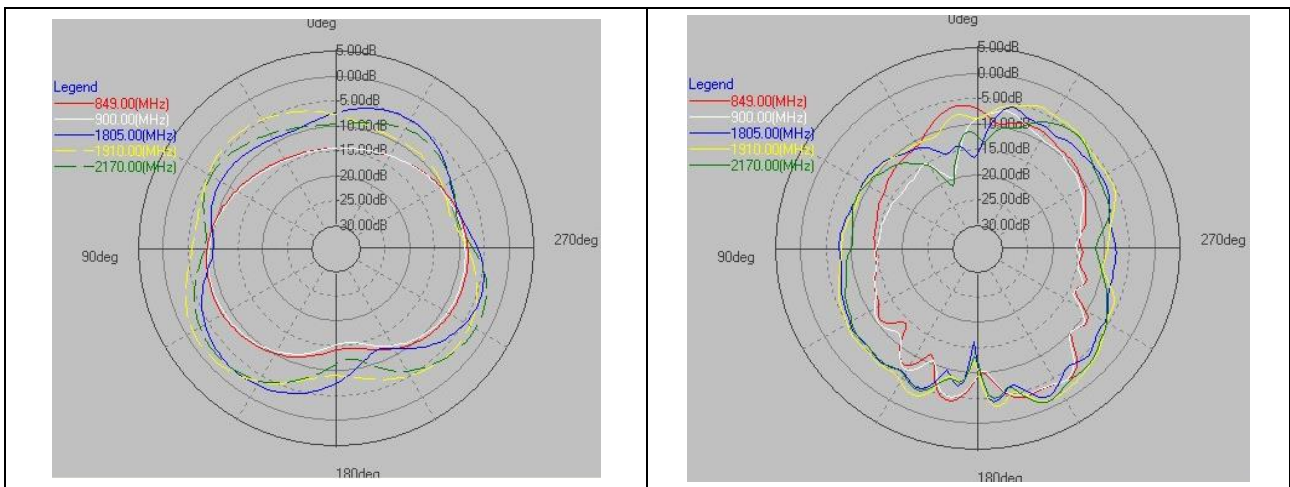

3.4 Efficiency

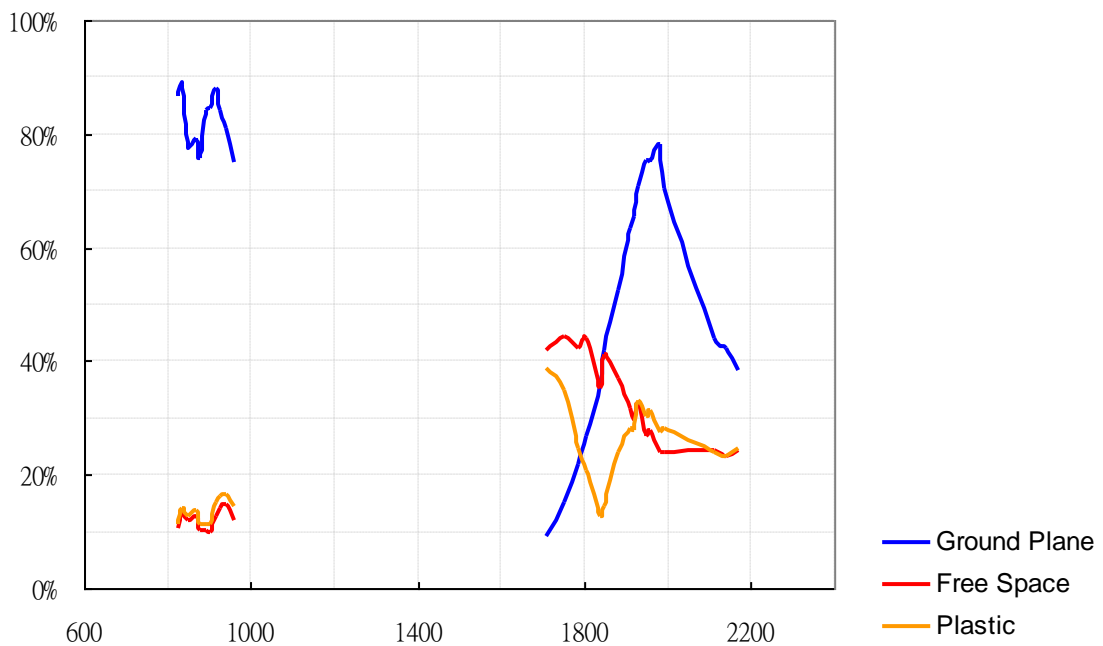

Miniature antennas couple to the ground plane for radiation so the efficiency of the antenna without a ground plane is largely degraded. These tests demonstrate the best performance (with the designed ground) and the worst performance (with no ground) possible of FXP.07. Adhere the antenna to a plastic changes the result, particularly in higher frequency bands.

3.5 Return Loss

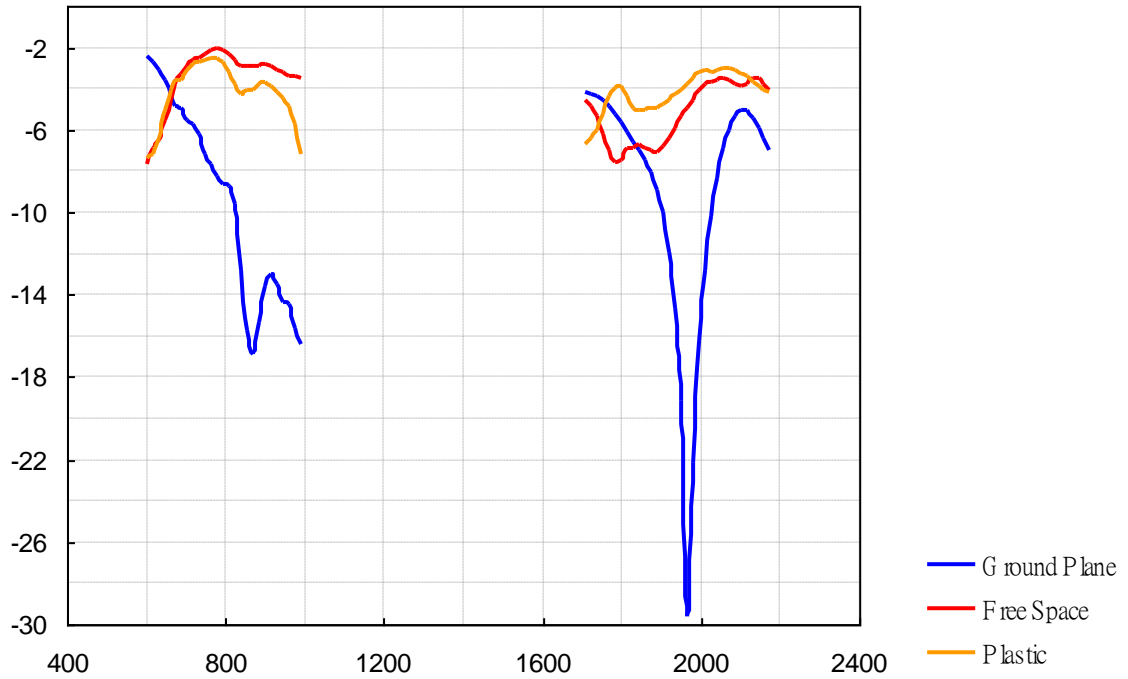

Return loss result also indicates that FXP.07 needs to connect to a ground plane for proper operation.

4. Mechanical Drawing

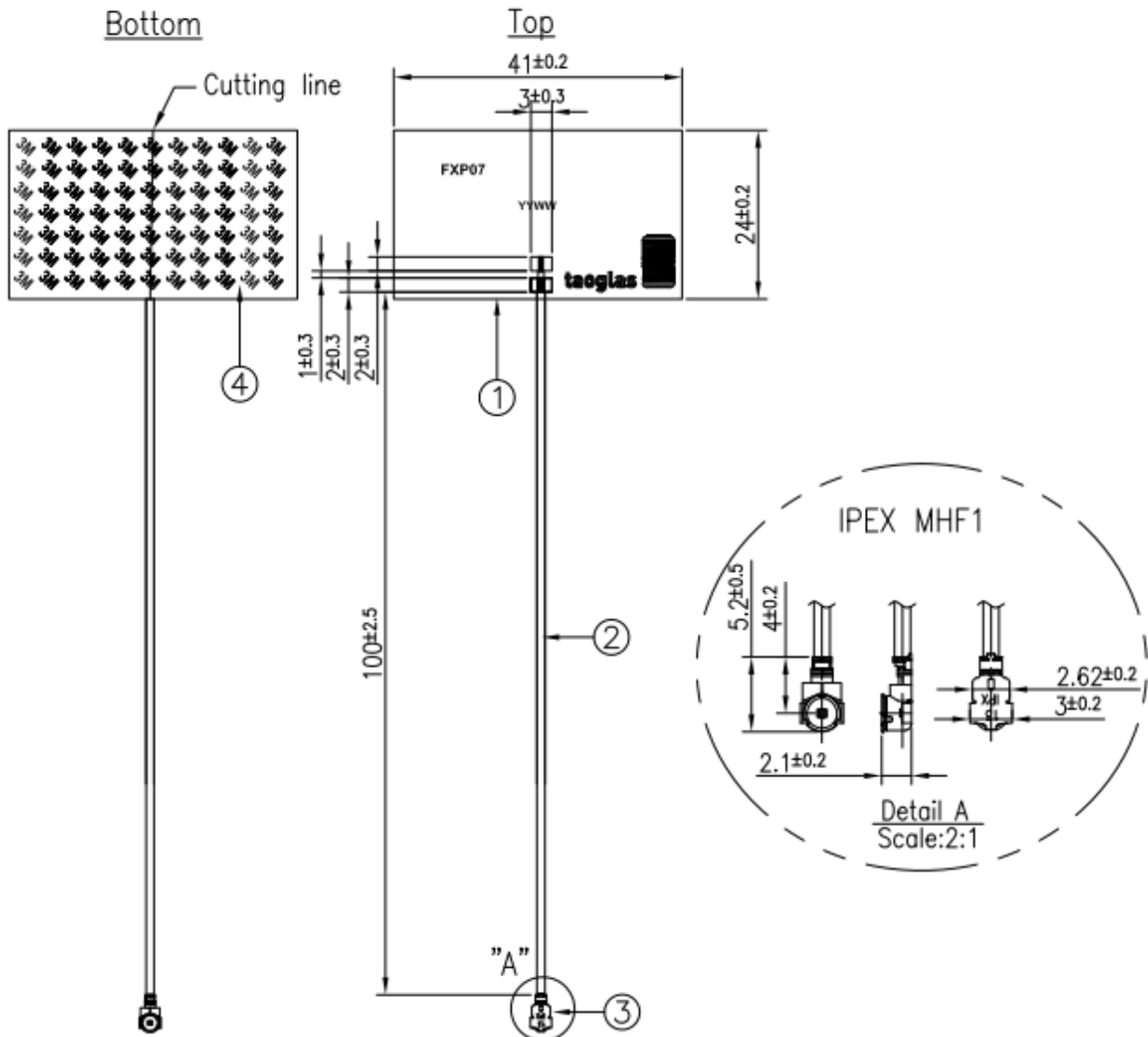

| | Name | Material | Finish | QTY |
|---|-----------------------|------------|-------------|-----|
| 1 | FXP07 PCB | FPCB 0.24t | Black | 1 |
| 2 | 1.13 Coaxial Cable | FEP | Black | 1 |
| 3 | IPEX MHF1 | Brass | Gold | 1 |
| 4 | Double-Sided Adhesive | 3M 467 | Brown Liner | 1 |

5. Packaging

FXP07.07.0100A

Packaging Specifications

100pcs FXP07.07.0100A per PE Bag
 Bag Dimensions - 150 x 100mm
 Weight - 80g

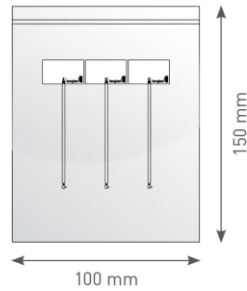

1000pcs FXP07.07.0100A per PE Large Bag
 Bag Dimensions - 250 x 200mm
 Weight - 800g

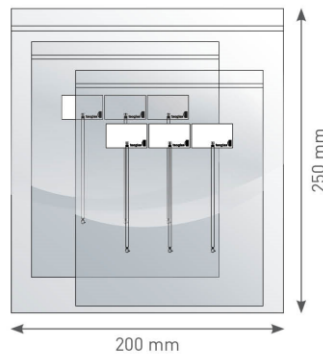

5,000 pcs FXP07.07.0100A per carton
 Carton - 320 x 320 x 250mm
 Weight - 4.5Kg

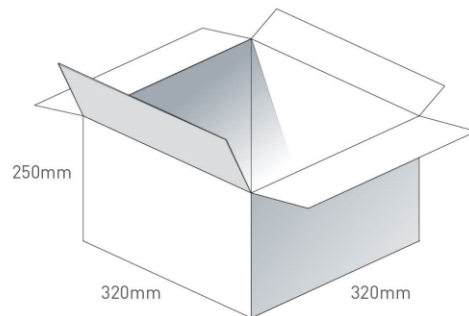

Pallet Dimensions 1200 x 1000 x 1350mm
 60 Cartons per Pallet
 12 Cartons per layer
 5 Layers

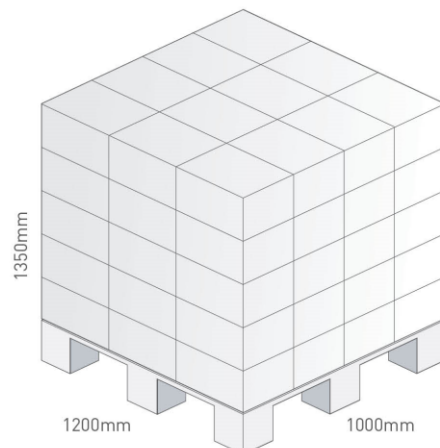

X-ON Electronics

Largest Supplier of Electrical and Electronic Components

Click to view similar products for [Antennas](#) category:

Click to view products by [Taoglas](#) manufacturer:

Other Similar products are found below :

[GAN30084EU](#) [930-033-R](#) [GW17.07.0250E](#) [1513563-1](#) [EXE902SM](#) [APAMPG-117](#) [MAF94383](#) [W3908B0100](#) [W6102B0100](#) [YE572113-30RSMM](#) [108-00014-50](#) [66089-2406](#) [SPDA17RP918](#) [A09-F8NF-M](#) [A09-F5NF-M](#) [RGFRA1903041A1T](#) [W3593B0100](#) [W3921B0100](#) [SIMNA-868](#) [SIMNA-915](#) [SIMNA-433](#) [W1044](#) [W1049B090](#) [A75-001](#) [WTL2449CQ1-FRSMM](#) [CPL9C](#) [EXB148BN](#) [0600-00060](#) [TRA9020S3PBN-001](#) [Y4503](#) [GD5W-28P-NF](#) [MA9-7N](#) [GD53-25](#) [GD5W-21P-NF](#) [C37](#) [MAF94051](#) [MA9-5N](#) [EXD420PL](#) [B1322NR](#) [QWFTB120](#) [MAF94271](#) [MAF94300](#) [GPSMB301](#) [FG4403](#) [AO-AGSM-OM54](#) [5200232](#) [MIKROE-2349](#) [WCM.01.0111](#) [MIKROE-2393](#) [MIKROE-2352](#)