



# TAOGLAS®



# Datasheet

## Freedom

**Part No:**  
FXP72.07.0053A

### Description:

2.4GHz Freedom Flexible PCB Antenna  
with 53mm 1.13 Cable and IPEX MHFI (U.FL) Connector

### Features:

- Low profile antenna
- Ground Coupling Effect
- Flexible PCB Antenna with 3M adhesive
- Dimensions: 31\*30.4\*0.2mm
- Cable: 53mm 1.13
- Connector: IPEX MHFI (U.FL)
- RoHS & Reach Compliant

1. Introduction	3
2. Specifications	4
3. Antenna Characteristics	5
4. Radiation Patterns	7
5. Mechanical Drawing	9
6. Installation Guide	10
7. Packaging	12
<hr/>	
Changelog	13

Taoglas makes no warranties based on the accuracy or completeness of the contents of this document and reserves the right to make changes to specifications and product descriptions at any time without notice. Taoglas reserves all rights to this document and the information contained herein. Reproduction, use or disclosure to third parties without express permission is strictly prohibited.



# 1. Introduction



The FXP72 Freedom 2.4GHz Antenna works on Wi-Fi, ZigBee, Bluetooth and ISM band at 2.4GHz. This antenna has been designed as a general solution to cover the current market applications, with easy installation through a cable connection. The antenna has been designed to work on different plastics material and thickness. We have selected a piece of ABS plastic with 2mm of thickness as a baseline for testing.

Many module manufacturers specify peak gain limits for any antennas that are to be connected to that module. Those peak gain limits are based on free-space conditions. In practice, the peak gain of an antenna tested in free-space can degrade by at least 1 or 2dBi when put inside a device. So ideally you should go for a slightly higher peak gain antenna than mentioned on the module specification to compensate for this effect, giving you better performance.

Upon testing of any of our antennas with your device and a selection of appropriate layout, integration technique, or cable, Taoglas can make sure any of our antennas' peak gain will be below the peak gain limits. Taoglas can then issue a specification and/or report for the selected antenna in your device that will clearly show it complying with the peak gain limits, so you can be assured you are meeting regulatory requirements for that module.

For example, a module manufacturer may state that the antenna must have less than 2dBi peak gain, but you don't need to select an embedded antenna that has a peak gain of less than 2dBi in free-space. This will give you a less optimized solution. It is better to go for a slightly higher free-space peak gain of 3dBi or more if available. Once that antenna gets integrated into your device, performance will degrade below this 2dBi peak gain due to the effects of GND plane, surrounding components, and device housing. If you want to be absolutely sure, contact Taoglas and we will test. Choosing a Taoglas antenna with a higher peak gain than what is specified by the module manufacturer and enlisting our help will ensure you are getting the best performance possible without exceeding the peak gain limits.

The cable and connector are fully customizable, for more information please contact your regional Taoglas customer support team.

## 2. Specifications

Wi-Fi MIMO	
Frequency (MHz)	2400~2500
Efficiency (%)	
2mm ABS	51.2
Free Space	23.3
Average Gain (dB)	
2mm ABS	-2.9
Free Space	-6.3
Peak Gain (dBi)	
2mm ABS	-0.5
Free Space	-4.4
Impedance	50 $\Omega$
Polarization	Linear
Radiation Pattern	Omni
VSWR	$\leq 1.5:1$
Max. input power	5W

Mechanical	
Dimensions	31 x 30.4 x 0.2 mm
Weight	1.2 g
Connector	MHFI (U.FL Compatible)
Cable	53mm of Mini-Coax 1.13 mm
Adhesive	3M 467
Environmental	
Temperature Range	-40°C to 85°C
Humidity	Non-condensing 65°C 95% RH

### 3. Antenna Characteristics

#### 3.1 Return Loss

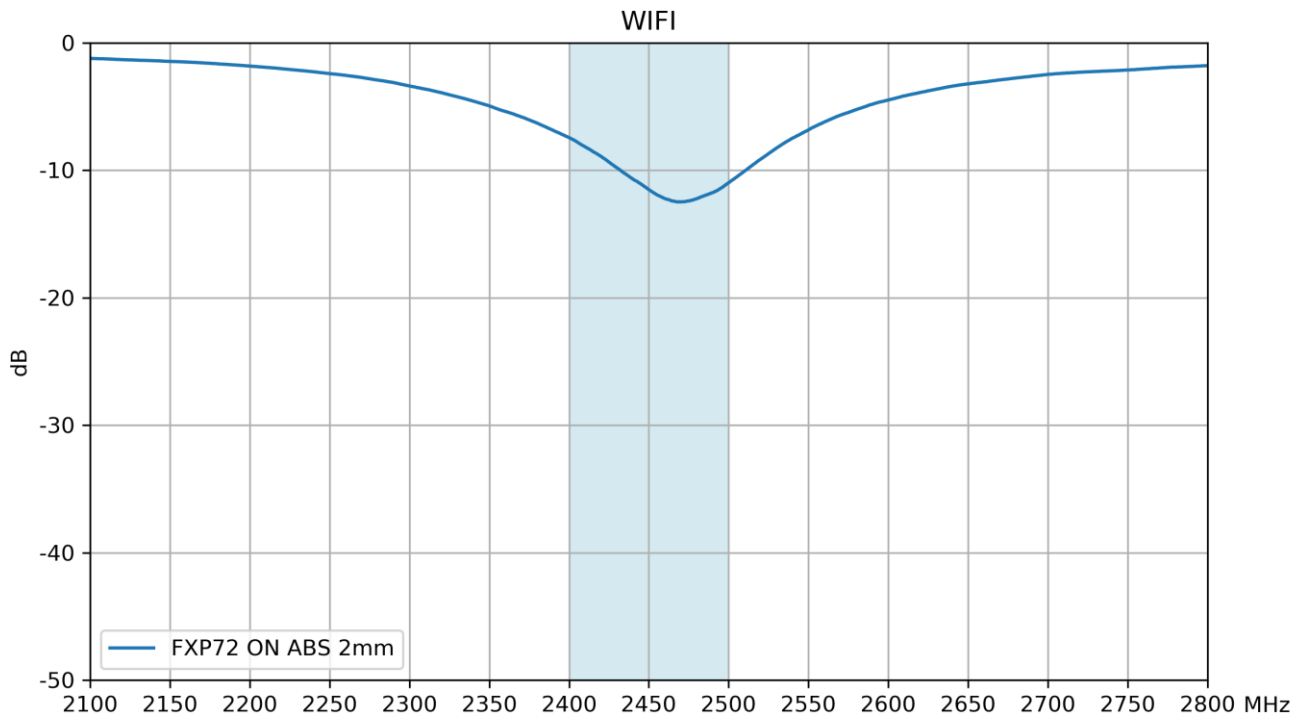

#### 3.2 Efficiency

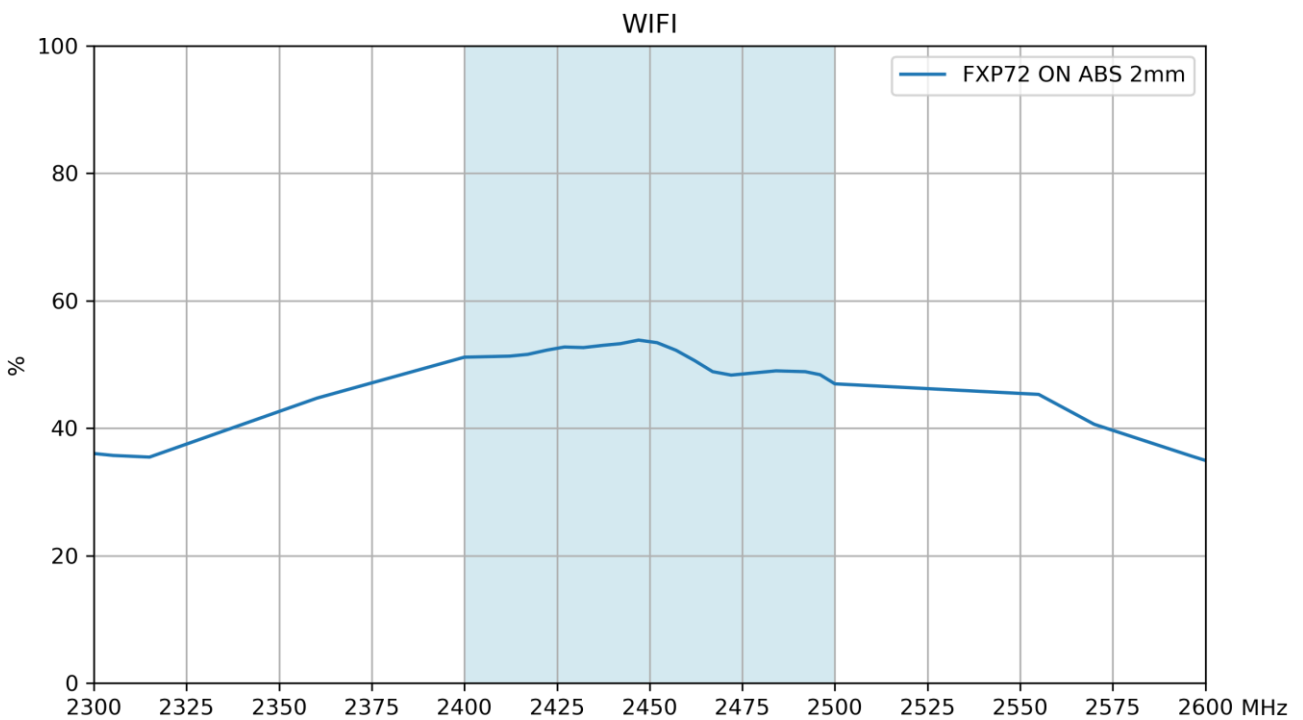

### 3.3 Average Gain

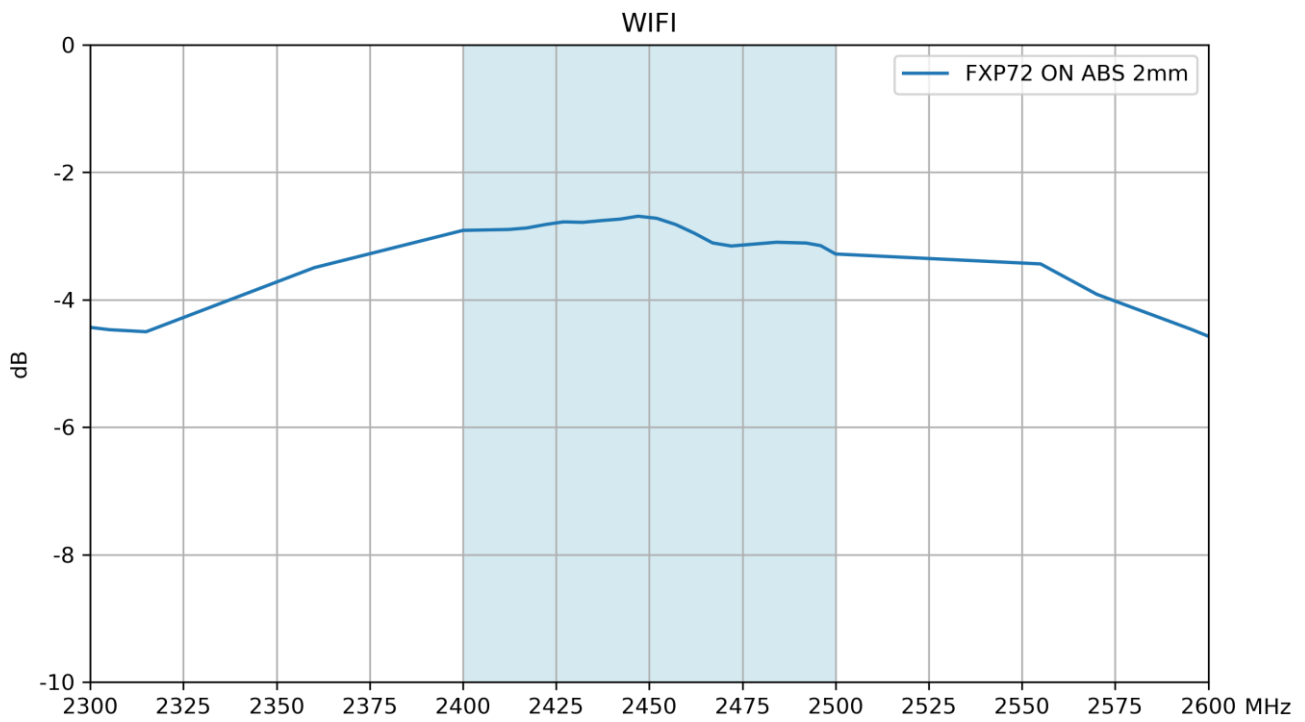

### 3.4 Peak Gain

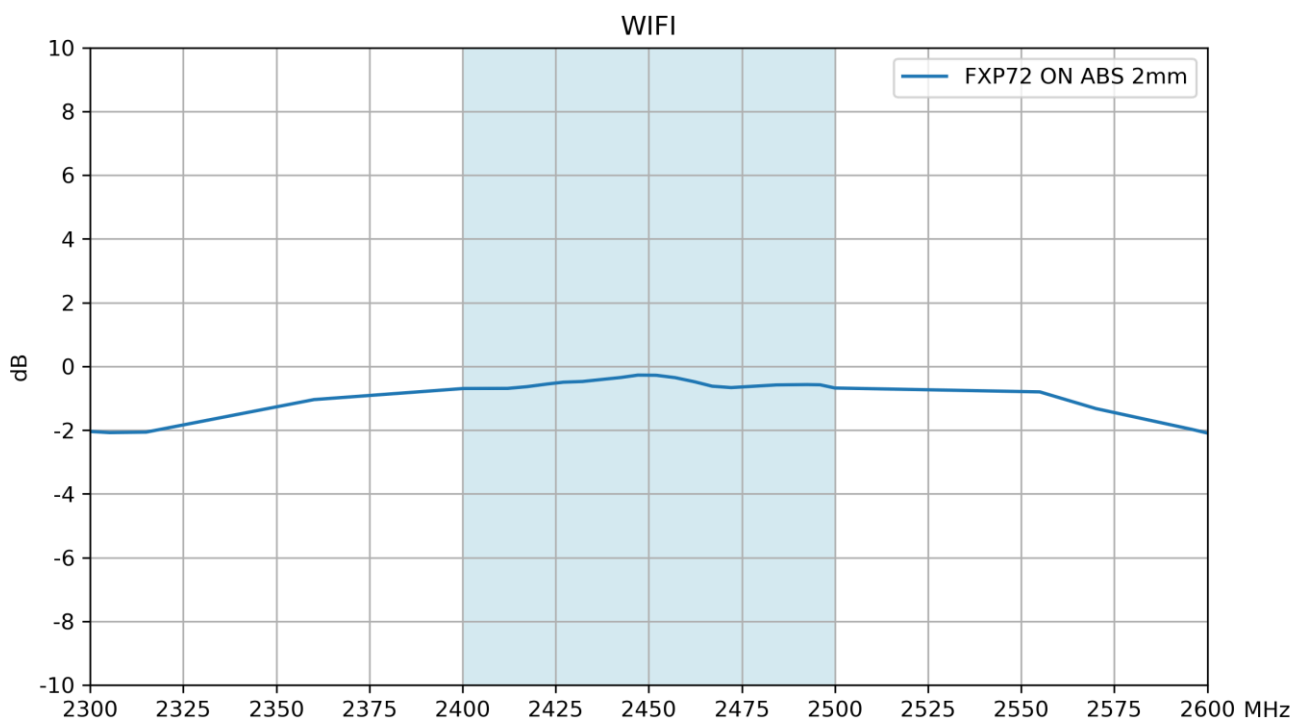

## 4. Radiation Patterns

### 4.1 Test Setup

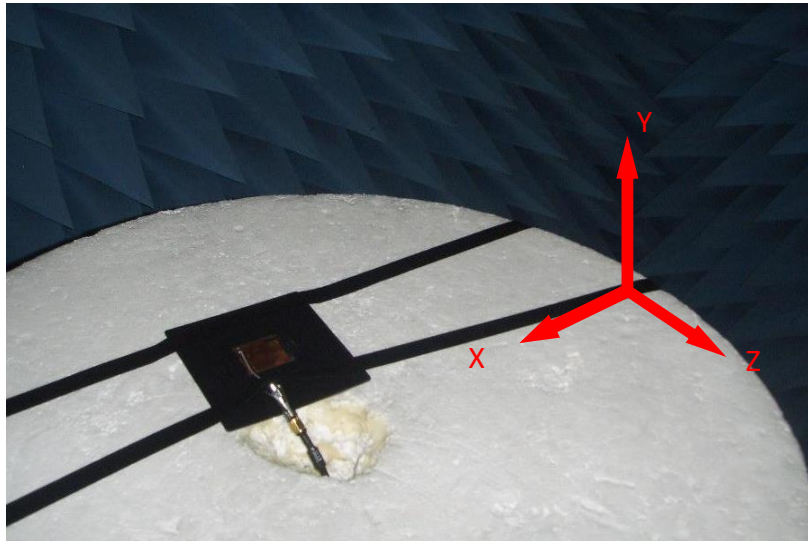

## 4.2 2450MHz 3D and 2D Radiation Patterns

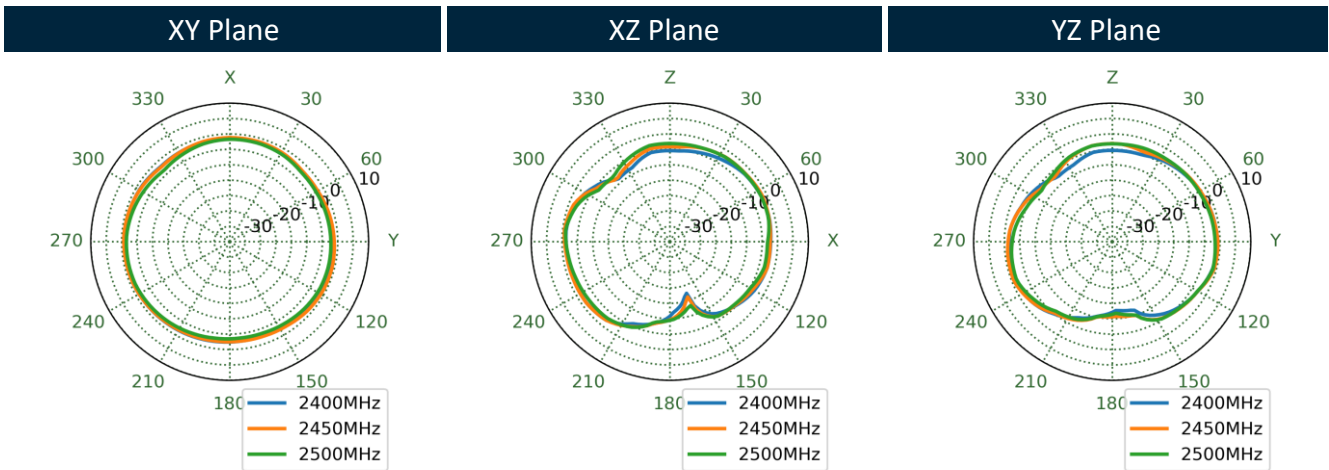
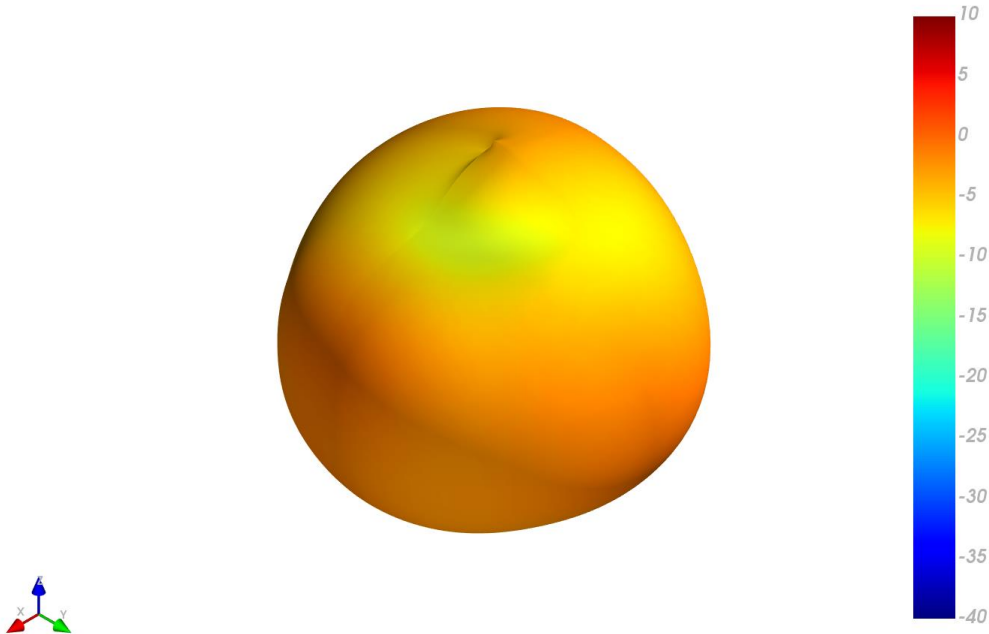



# 5. Mechanical Drawing (Units: mm)

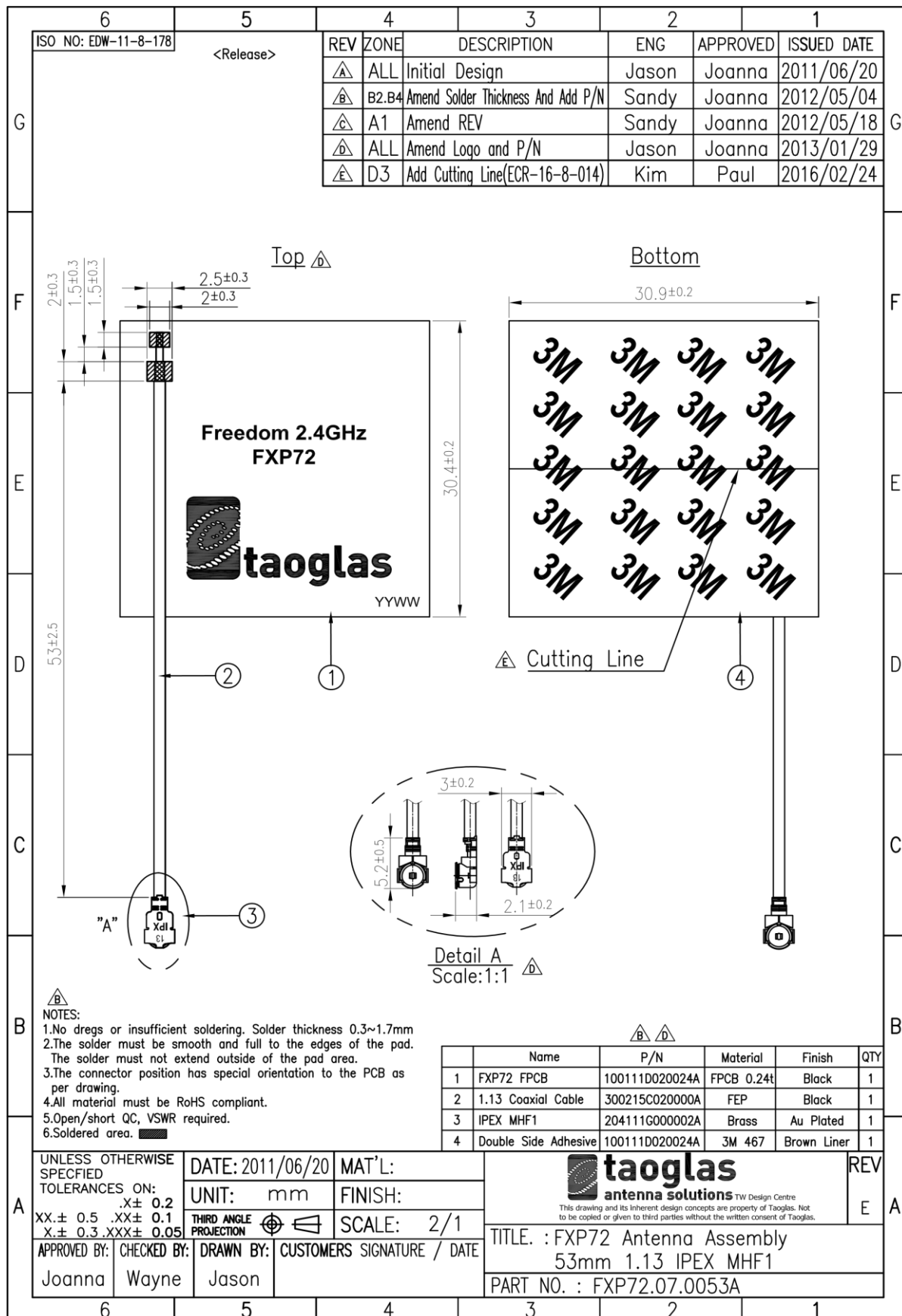

## 6. Mounting Guidelines

This versatile antenna design is suitable for cases where there is not enough space for a thicker antenna. FXP72 can be right next to the device main board. This antenna uses the device main board as a ground plane through a capacitive coupling effect and keeping antenna characteristics.

The only restriction for this design is the radiated elements of the antenna must be free of metal. In the next figure 12 is shown the minimum clearance necessary for the antenna and on Figure 13 the non-desired main board shape on the antenna section. The size of the ground plane used on the testing is 40X60 mm and was allocated as in figure 12.

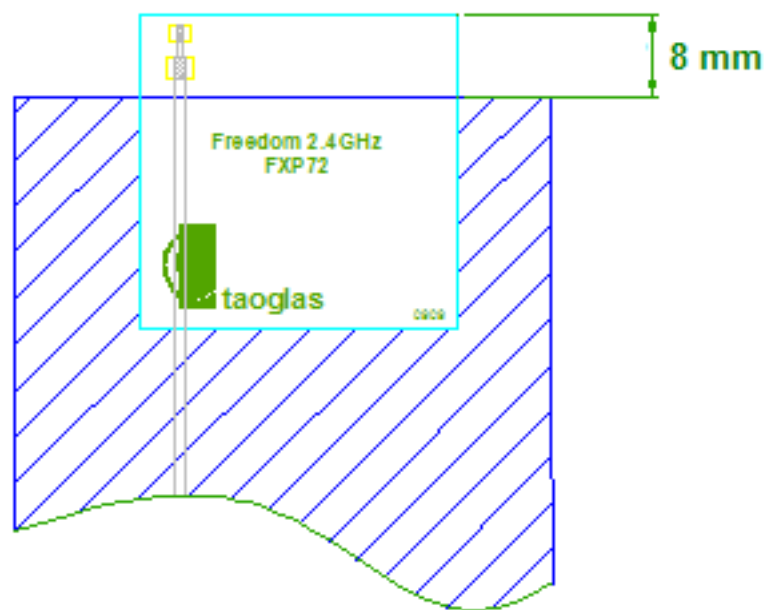

The size and shape of the ground plane can change. The only restrictions to get maximum performance are that the antenna must be allocated along the shortest edge of the device board, and the ground plane on that edge must have a flat shape horizontally, in order words the ground plane cannot come around of the antenna sides on that section. The next figure 13 shows a non-desired ground plane environment.

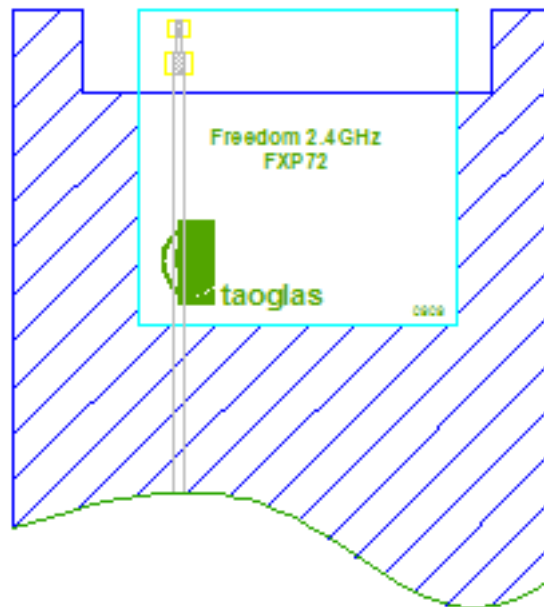

The size of the ground plane used on the testing had a dimension of 40X60 mm, see next figure 14. The antenna was placed in the center of one shortest edge. The antenna was in between the ABS plastic and ground plane, having a clearance of 8 mm. The Antenna was tested into the Satimo system chamber and with a network analyzer. The antenna was also tested on in free space, just the antenna stuck out on the ABS plastic of 1.5 mm of thickness.

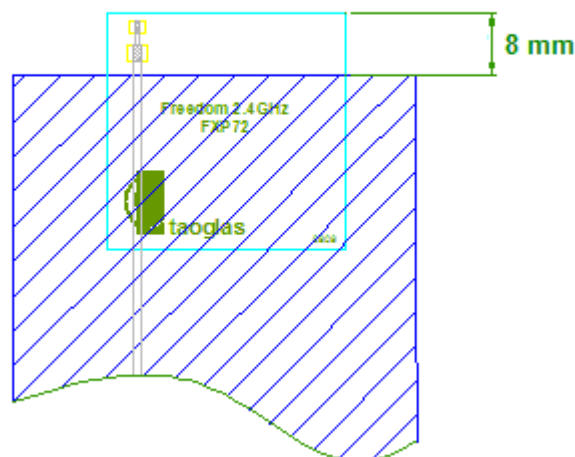

## 7. Packaging

100pc FXP72.07.0053A per Small PE Bag

Dimensions: 210\*100mm

Weight: 130g

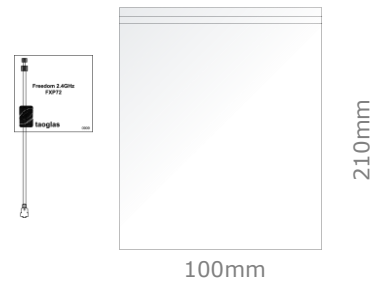

1000pcs FXP72.07.0053A per Large PE Bag

Dimensions: 430\*280mm

Weight: 1.3Kg



2000pcs FXP72.07.0053A per Carton

Carton Dimensions: 330\*190\*190 mm

Weight: 2.6Kg

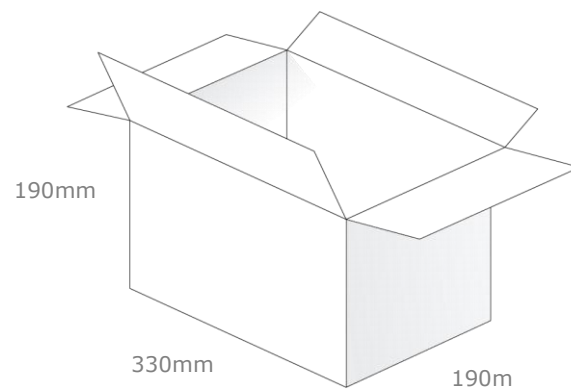

Pallet Dimensions:

1200\*1000\*1340mm

108 Cartons per Pallet

18 Cartons per layer, 6 Layers

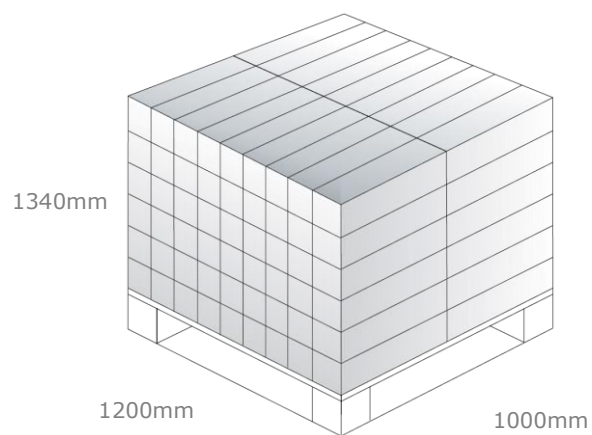

Changelog for the datasheet

**SPE-12-8-012 - FXP72.07.0053A**

**Revision: F (Current Version)**

Date:	2019-12-13
Changes:	Updated with new data
Changes Made by:	Jack Conroy

**Previous Revisions**

**Revision: E**

Date:	2019-08-28
Changes:	Packaging
Changes Made by:	Russell Meyler

**Revision: D**

Date:	2015-08-20
Changes:	Added note on Gain
Changes Made by:	Aine Doyle

**Revision: C**

Date:	2015-01-14
Changes:	Updated Intro
Changes Made by:	Andy Mahoney

**Revision: B**

Date:	2015-01-13
Changes:	Packaging Details Updated
Changes Made by:	Andy Mahoney

**Revision: A (Original First Release)**

Date:	2012-06-02
Notes:	
Author:	Aine Doyle



**TAOGLAS**®

[www.taoglas.com](http://www.taoglas.com)



## X-ON Electronics

Largest Supplier of Electrical and Electronic Components

*Click to view similar products for [Antennas](#) category:*

*Click to view products by [Taoglas](#) manufacturer:*

Other Similar products are found below :

[GAN30084EU](#) [930-033-R](#) [GW17.07.0250E](#) [1513563-1](#) [EXE902SM](#) [APAMPG-117](#) [MAF94383](#) [W3908B0100](#) [W6102B0100](#) [YE572113-30RSMM](#) [108-00014-50](#) [66089-2406](#) [SPDA17RP918](#) [A09-F8NF-M](#) [A09-F5NF-M](#) [RGFRA1903041A1T](#) [W3593B0100](#) [W3921B0100](#) [SIMNA-868](#) [SIMNA-915](#) [SIMNA-433](#) [W1044](#) [W1049B090](#) [A75-001](#) [WTL2449CQ1-FRSMM](#) [CPL9C](#) [EXB148BN](#) [0600-00060](#) [TRA9020S3PBN-001](#) [Y4503](#) [GD5W-28P-NF](#) [MA9-7N](#) [GD53-25](#) [GD5W-21P-NF](#) [C37](#) [MAF94051](#) [MA9-5N](#) [EXD420PL](#) [B1322NR](#) [QWFTB120](#) [MAF94271](#) [MAF94300](#) [GPSMB301](#) [FG4403](#) [AO-AGSM-OM54](#) [5200232](#) [MIKROE-2349](#) [WCM.01.0111](#) [MIKROE-2393](#) [MIKROE-2352](#)