

SPECIFICATION

PATENT PENDING

Part No : **FXUB70.A.07.C.001**

Product Name : 4G LTE Wide Band Flex MIMO Antenna
698-3000 MHz

Features : Patent Pending
Covers 4G LTE, 3G HSPA, 2G GSM/GPRS/CDMA
Ground Plane Independent
698-3000 MHz
5 dBi Peak Gain
182*21*0.2 mm size
150mm Ø1.37mm Cable IPEX MHFI
(U.FL Compatible)
RoHS Compliant



1. Introduction

The patent pending FXUB70 LTE Wide-band flexible wideband antenna has been designed to cover all working frequencies in the 698-3000 MHz spectrum, covering all Cellular, 2.4GHz Wi-Fi, ISM and AGPS. The antenna is delivered with a flexible body with excellent efficiencies on all bands, ground independent, with cable and connector for easy installation.

The FXUB70 flexible polymer antenna, at 182*21*0.2mm, is ultra thin and truly wideband with high efficiencies across the bands. It is assembled by a simple “peel and stick” process, attaching securely to non-metal surfaces via 3M 467 automotive approved adhesive. It enables designers to use only one antenna that covers all common frequencies for LTE and 4G globally.

The FXUB70 antenna is a durable flexible polymer antenna that has a peak gain of 5dBi, an efficiency of more than 45% across the bands and is designed to be mounted directly onto plastic. It is an ideal choice for any device maker that needs to keep manufacturing costs down over the lifetime of a product. It is ground plane independent and delivered with a cable and connector for easy connecting to the wireless module or customer PCB. Like all such antennas, care should be taken to mount the antenna at least 10mm from metal components or surfaces, and ideally 20mm for best radiation efficiency.

Cables and Connectors are customizable. If cable routing is not convenient on this antenna, the alternative FXUB71 is recommended.

2. Specification

ELECTRICAL								
Band	700/800/ 850/900	1575	1700/ 1800/1900	2100	2300	2400	2600	3500
Standard	CELL	GPS	CELL	CELL	CELL	ISM	CELL	CELL
Frequency (MHz)	698-960	1575.42	1710 -1990	1755 -2170	2305 -2360	2400 -2500	2500 -2690	3400 -3600
Max VSWR	2:1	2:1	1.8:1	1.7:1		1.7:1	2.3:1	
Max Return Loss (dB)	-10	-10	-11	-12		-12	-8	
Peak Gain (dBi)	1	2.5	3.5	5		5	4.5	
Efficiency (%)	50	75	78	65		75	75	
Average Gain (dB)	-3	-2	-2	-2.5		-2	-2	
Radiation Properties	Omni-directional							
Max Input Power (Watts)	5							
Polarization	Linear							
Impedance (Ohms)	50 Ohms							

*Antenna measured on plastic plate of 3 mm thickness.

MECHANICAL	
Dimensions (mm)	182*21*0.2 mm
Material	Flexible Polymer
Connector and Cable	U.FL and 1.37 mm mini coax with 150 mm
Cable length	150 mm

ENVIRONMENTAL	
Operation Temperature	-40°C to +85°C
Storage Temperature	-40°C to +85°C
Relative Humidity	40% to 95%
RoHs Compliant	Yes

LTE BANDS				
Band Number	LTE / LTE-Advanced / WCDMA / HSPA / HSPA+ / TD-SCDMA			
	Uplink	Downlink	MIMO 1	MIMO 2
1	UL: 1920 to 1980	DL: 2110 to 2170	✓	✓
2	UL: 1850 to 1910	DL: 1930 to 1990	✓	✓
3	UL: 1710 to 1785	DL: 1805 to 1880	✓	✓
4	UL: 1710 to 1755	DL: 2110 to 2155	✓	✓
5	UL: 824 to 849	DL: 869 to 894	✓	✓
7	UL: 2500 to 2570	DL: 2620 to 2690	✓	✓
8	UL: 880 to 915	DL: 925 to 960	✓	✓
9	UL: 1749.9 to 1784.9	DL: 1844.9 to 1879.9	✓	✓
11	UL: 1427.9 to 1447.9	DL: 1475.9 to 1495.9	✗	✗
12	UL: 699 to 716	DL: 729 to 746	✓	✓
13	UL: 777 to 787	DL: 746 to 756	✓	✓
14	UL: 788 to 798	DL: 758 to 768	✓	✓
17	UL: 704 to 716	DL: 734 to 746 (LTE only)	✓	✓
18	UL: 815 to 830	DL: 860 to 875 (LTE only)	✓	✓
19	UL: 830 to 845	DL: 875 to 890	✓	✓
20	UL: 832 to 862	DL: 791 to 821	✓	✓
21	UL: 1447.9 to 1462.9	DL: 1495.9 to 1510.9	✗	✗
22	UL: 3410 to 3490	DL: 3510 to 3590	✓	✓
23	UL: 2000 to 2020	DL: 2180 to 2200 (LTE only)	✓	✓
24	UL: 1625.5 to 1660.5	DL: 1525 to 1559 (LTE only)	✓	✓
25	UL: 1850 to 1915	DL: 1930 to 1995	✓	✓
26	UL: 814 to 849	DL: 859 to 894	✓	✓
27	UL: 807 to 824	DL: 852 to 869 (LTE only)	✓	✓
28	UL: 703 to 748	DL: 758 to 803 (LTE only)	✓	✓
29	UL: -	DL: 717 to 728 (LTE only)	✓	✓
30	UL: 2305 to 2315	DL: 2350 to 2360 (LTE only)	✓	✓
31	UL: 452.5 to 457.5	DL: 462.5 to 467.5 (LTE only)	✗	✗
32	UL: -	DL: 1452 - 1496	✗	✗
35		1850 to 1910	✓	✓
38		2570 to 2620	✓	✓
39		1880 to 1920	✓	✓
40		2300 to 2400	✓	✓
41		2496 to 2690	✓	✓
42		3400 to 3600	✓	✓
43		3600 to 3800	✗	✗

*Covered bands represent an efficiency greater than 20%

3. Antenna Parameters

3.1. Return Loss

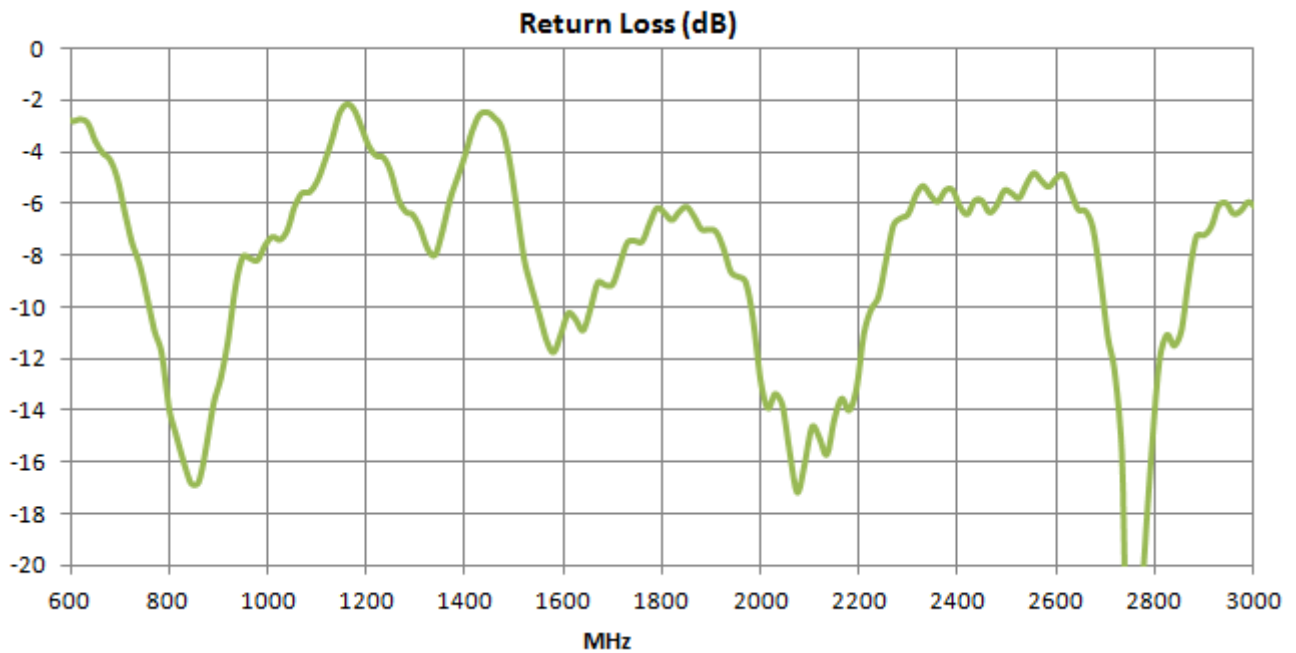

Figure 1. Return loss of FXUB70 Port 1.

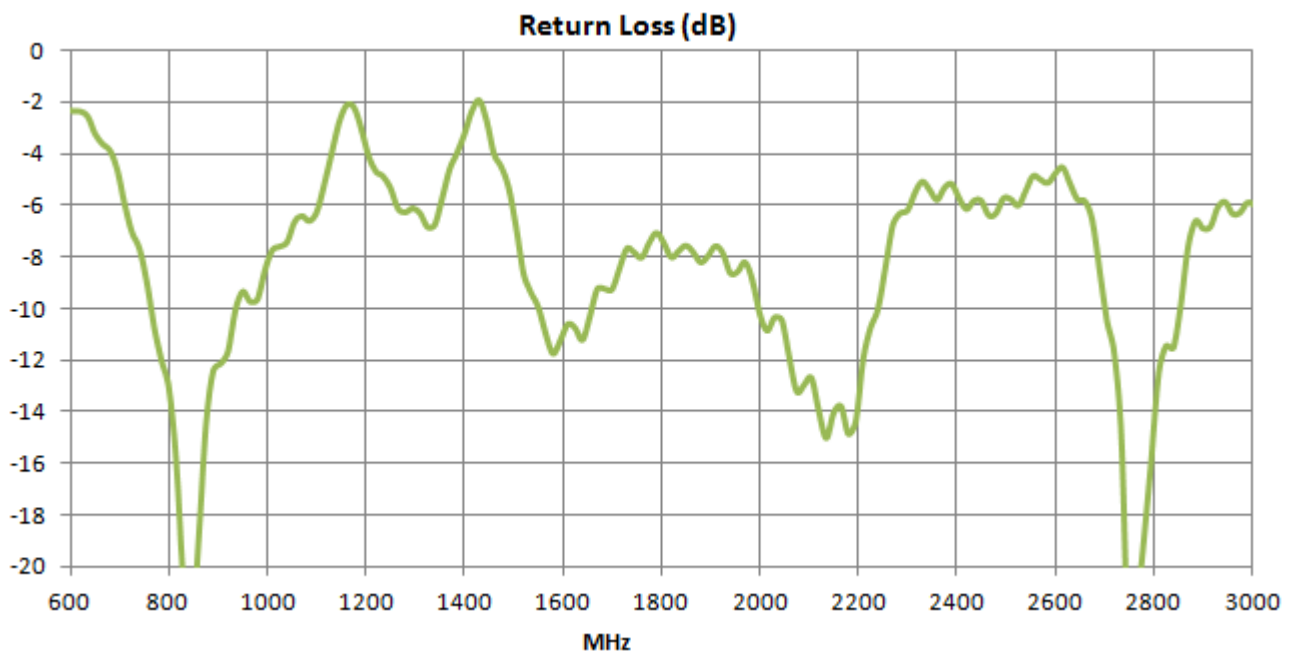

Figure 2. Return loss of FXUB70 Port 2.

3.2. VSWR

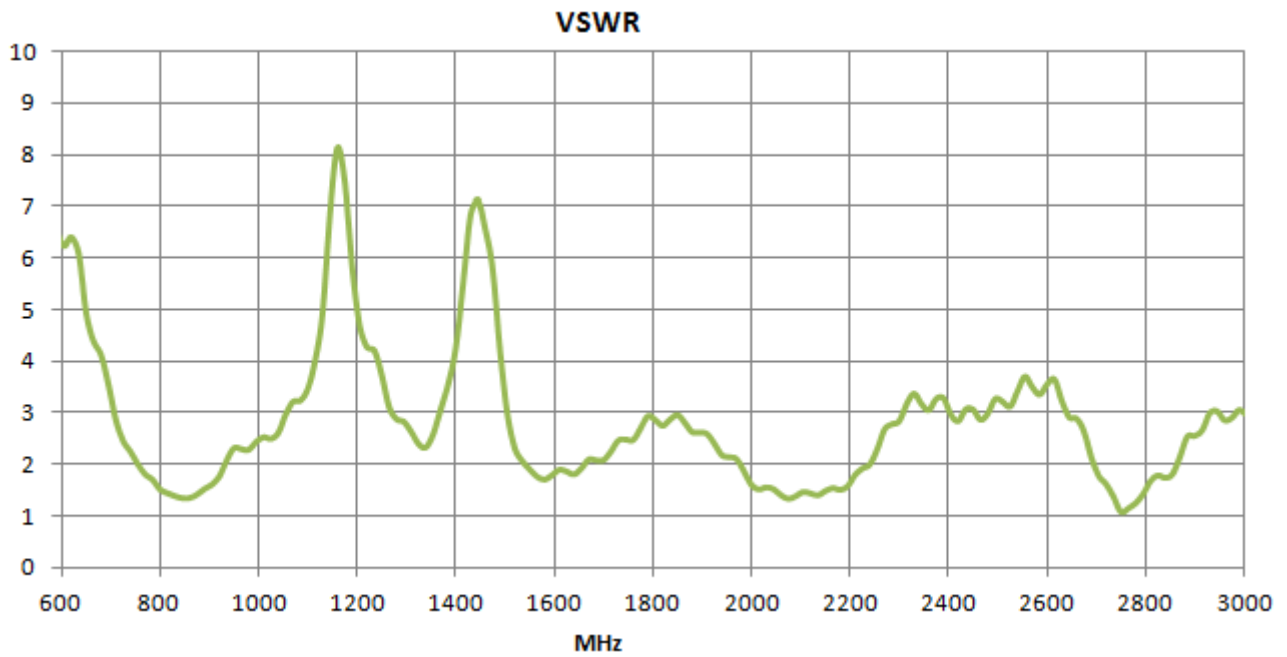

Figure 3. VSWR of FXUB70 Port 1.

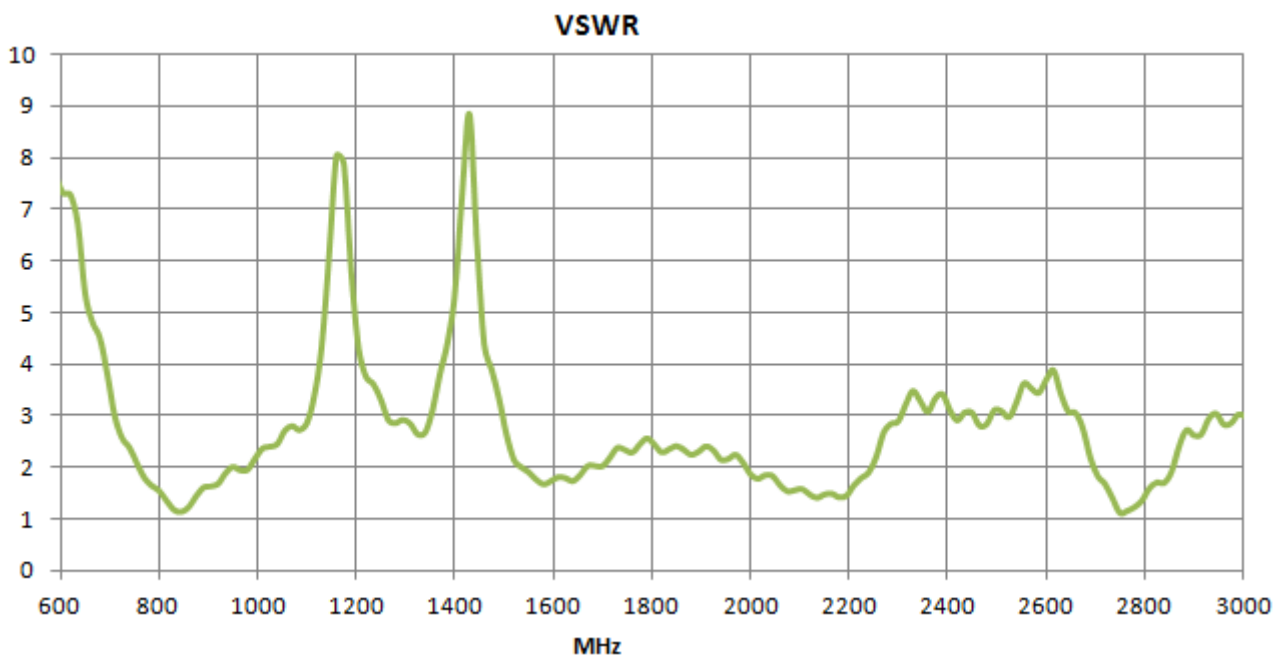

Figure 4. VSWR of FXUB70 Port 1.

3.3. Isolation

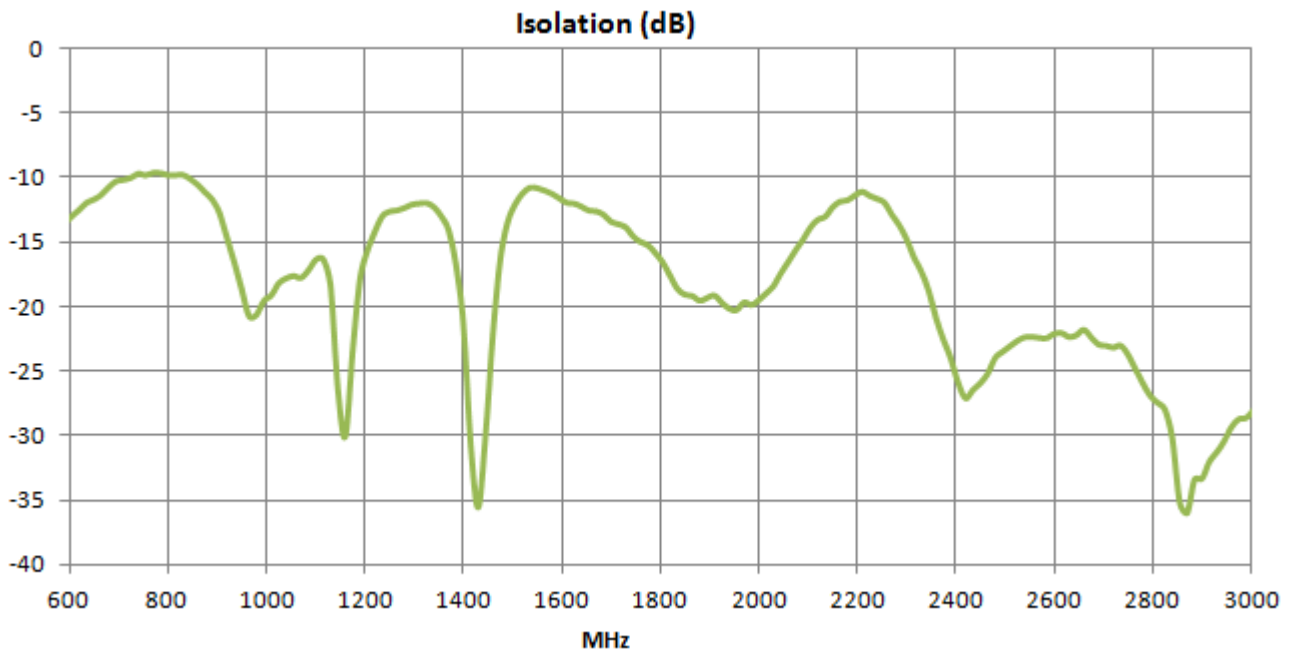

Figure 5. Isolation of FXUB70 in between Port 1 and Port 2.

3.4. Envelope Correlation Coefficient

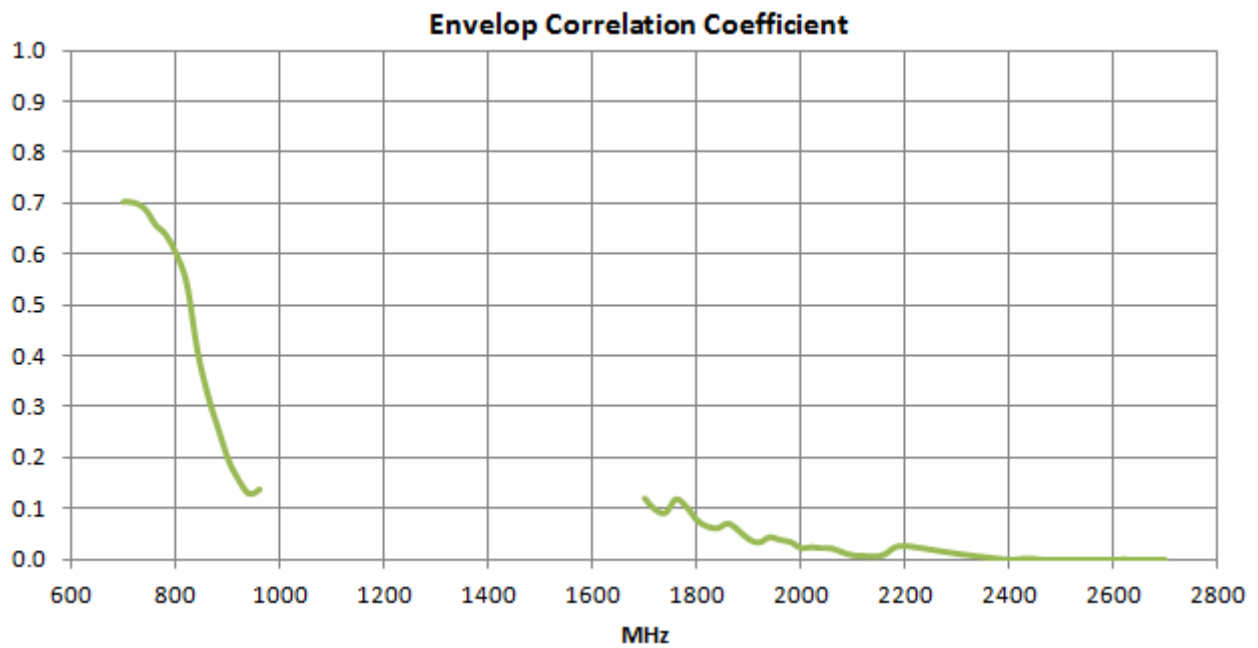

Figure 6. ECC of FXUB70 in between Port 1 and Port 2.

3.5. Peak Gain

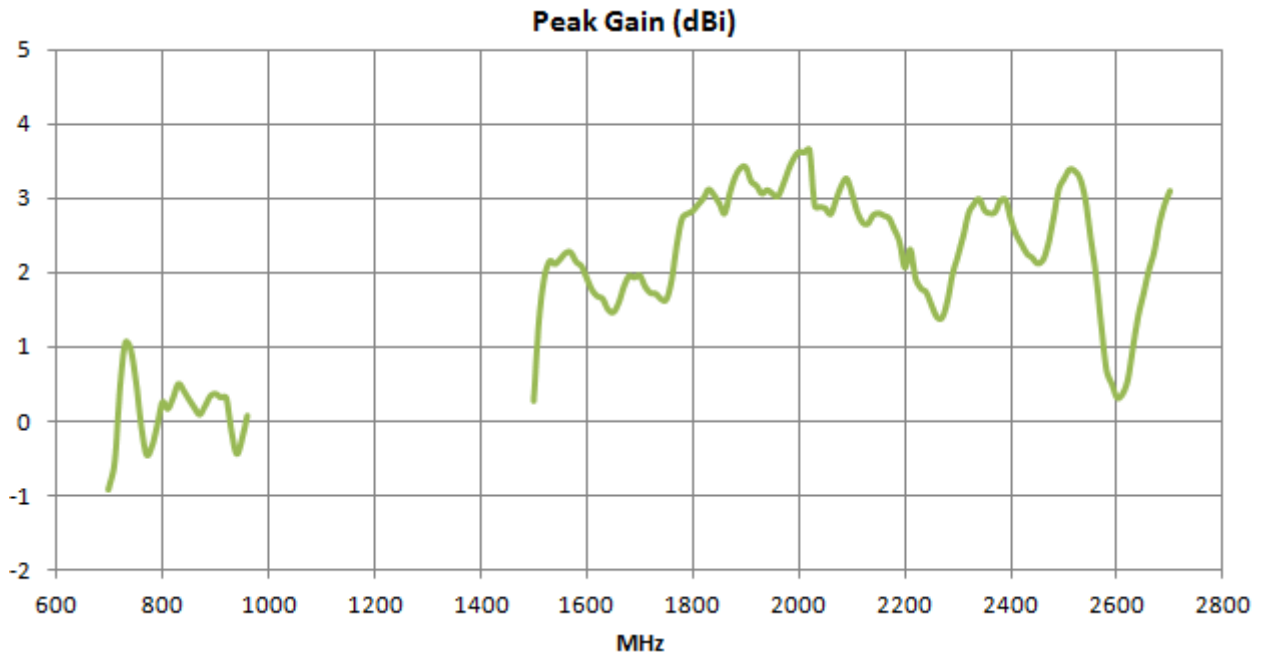

Figure 7. Peak Gain of FXUB70 Port 1.

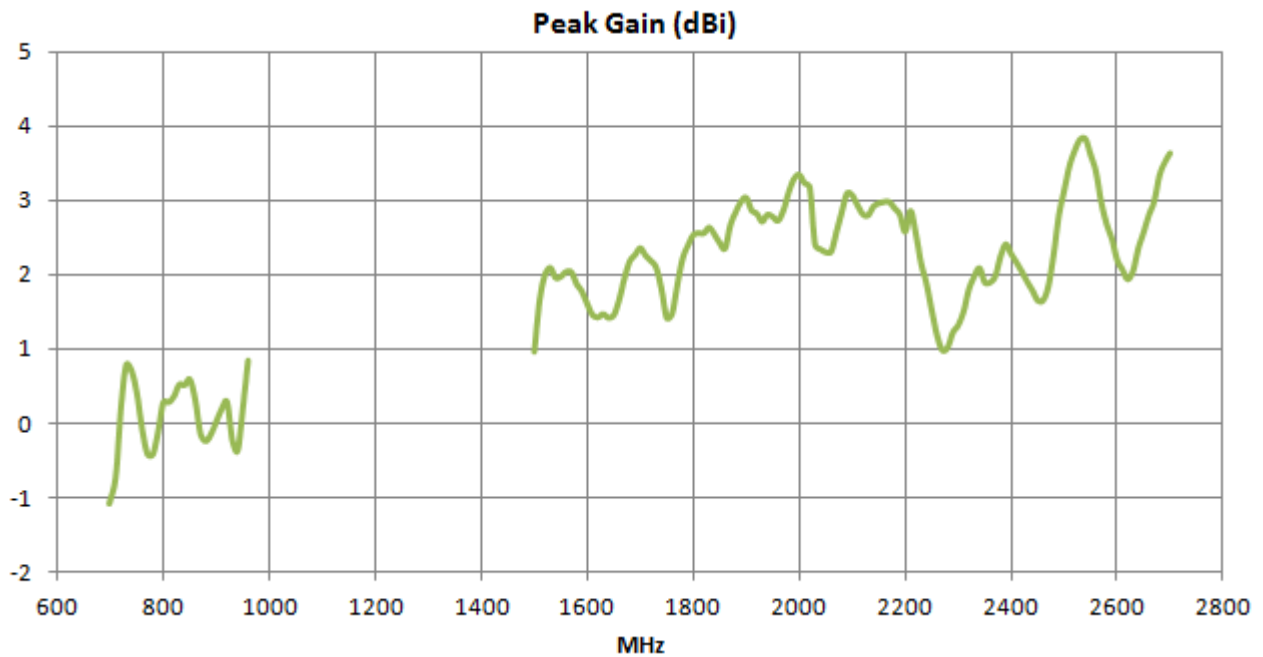

Figure 8. Peak Gain of FXUB70 Port 2.

3.6. Efficiency

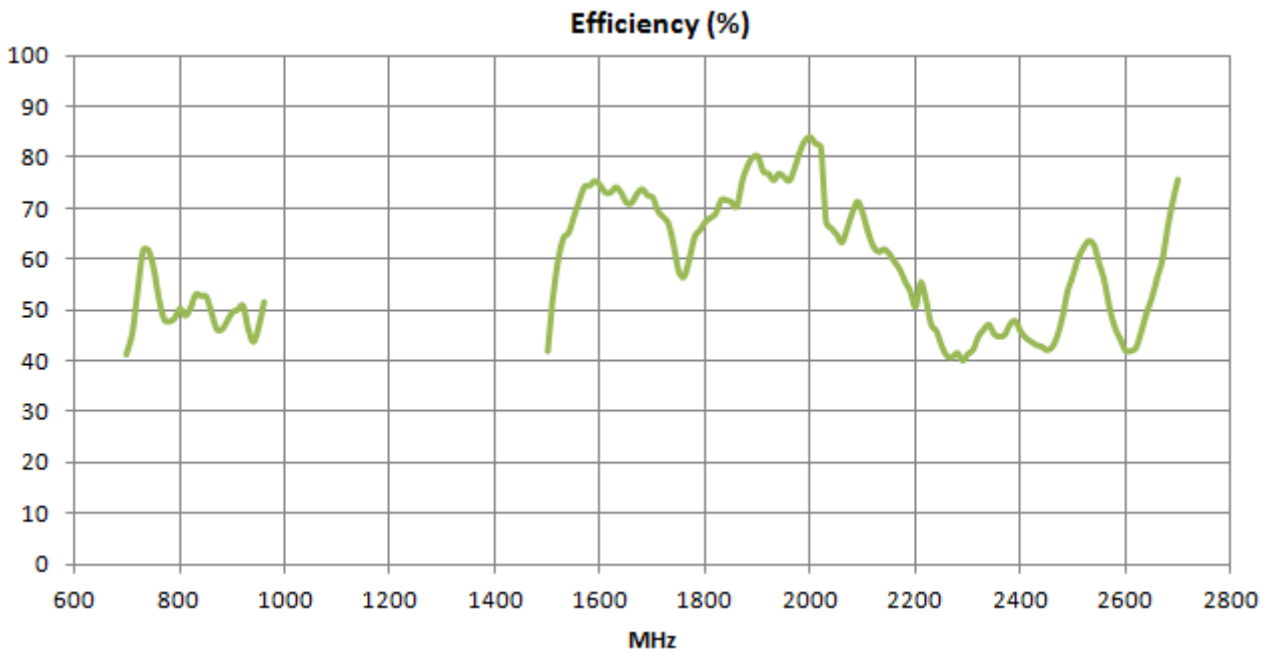

Figure 9. Efficiency of FXUB70 Port 1.

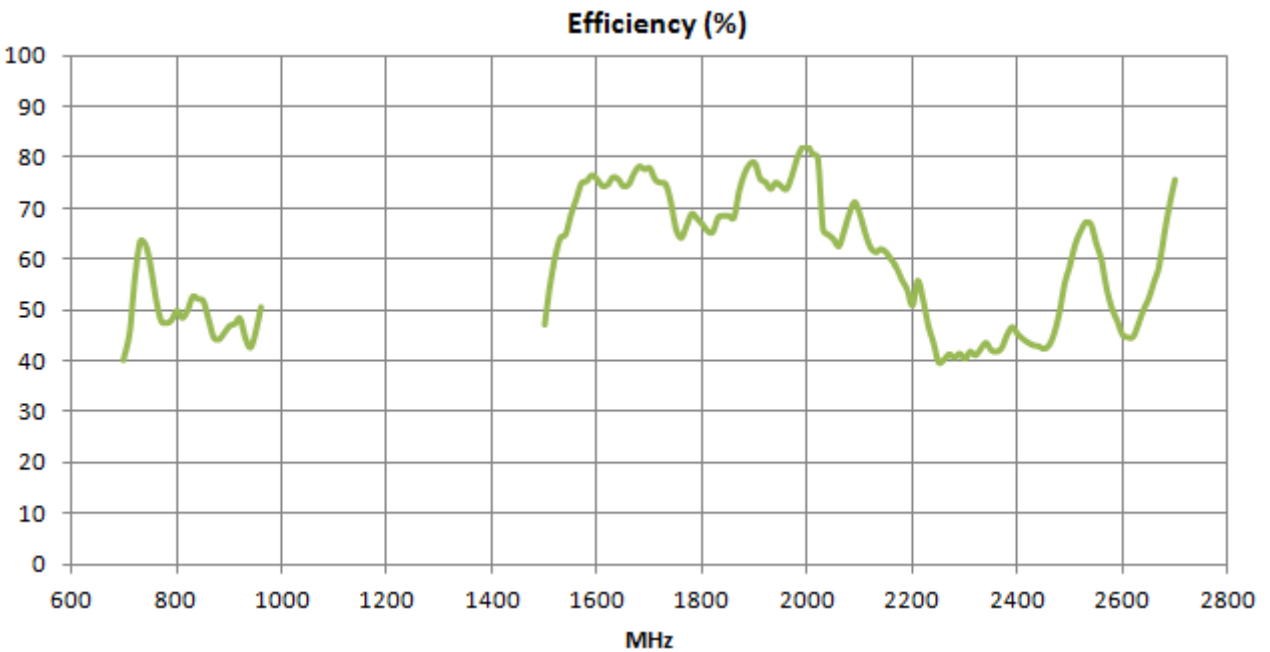

Figure 10. Efficiency of FXUB70 Port 2.

3.7. Average Gain

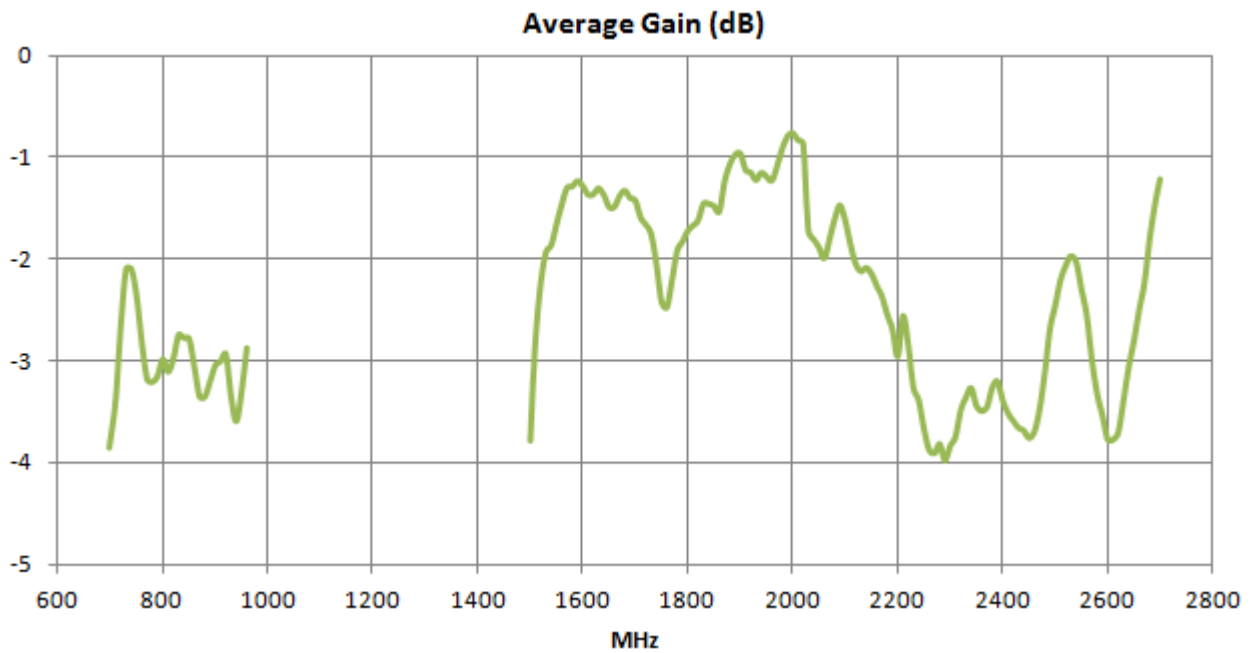

Figure 11. Average Gain of FXUB70 Port 1.

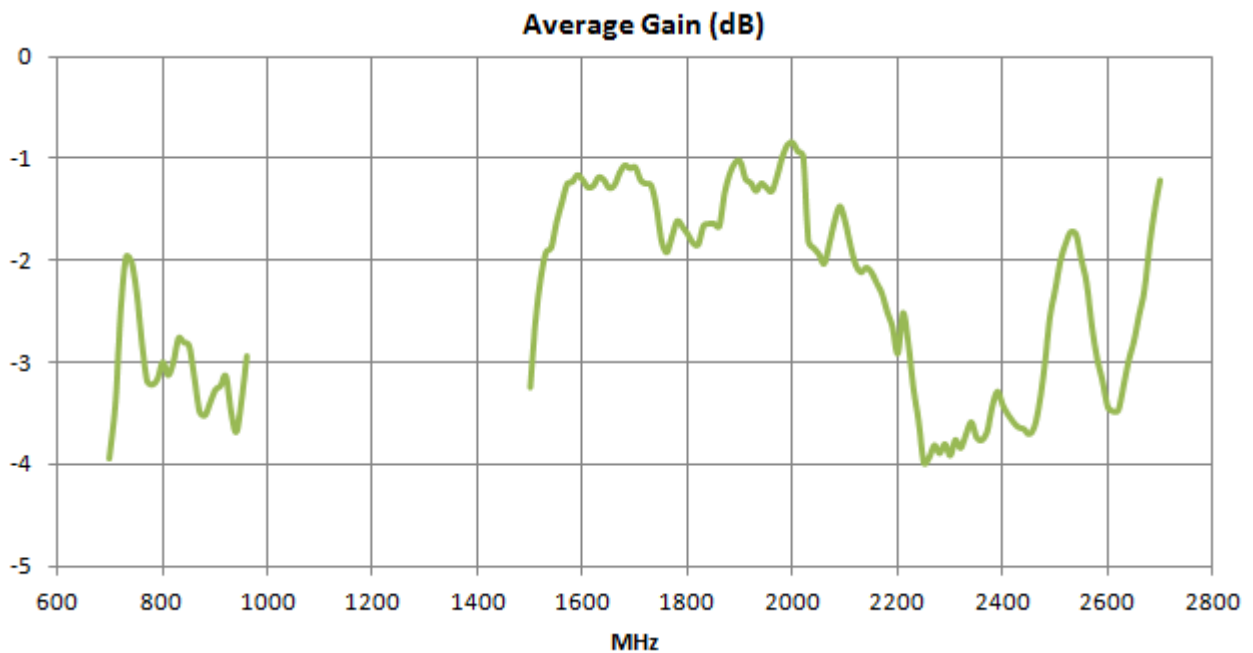

Figure 12. Average Gain of FXUB70 Port 2.

3.8. Radiation Pattern

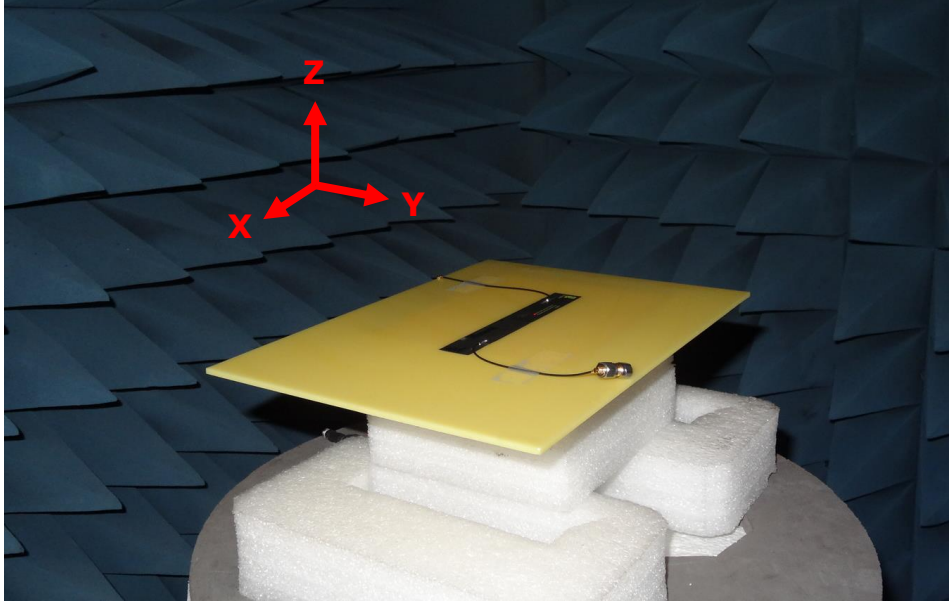

Figure 13. Radiation Pattern Reference of FXUB70.

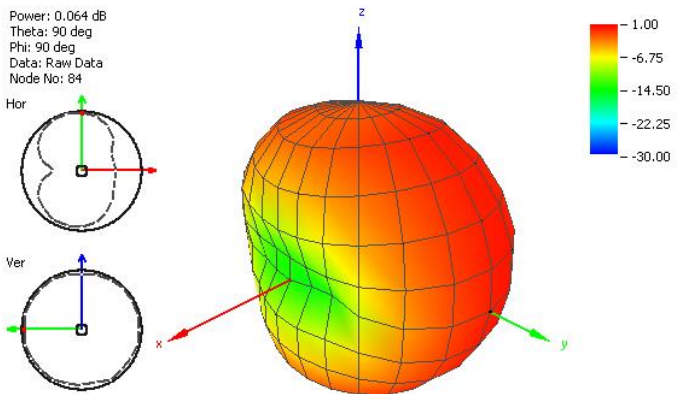

Figure 14. Radiation Pattern at 750 MHz of FXUB70 Port 1.

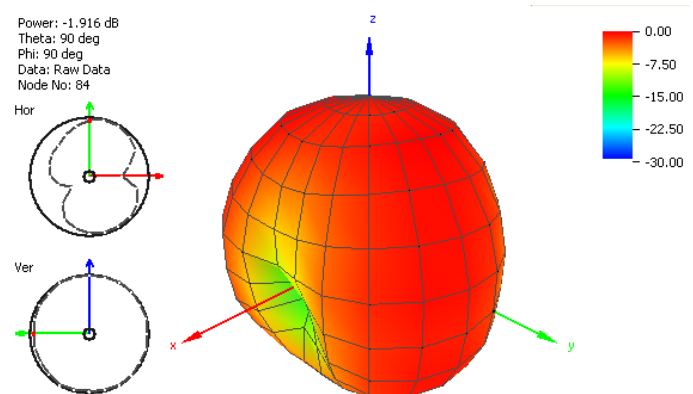

Figure 15. Radiation Pattern at 750 MHz of FXUB70 Port 2.

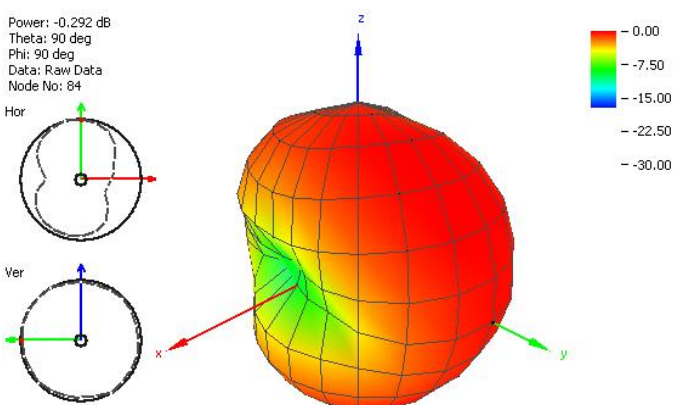

Figure 16. Radiation Pattern at 850 MHz of FXUB70 Port 1.

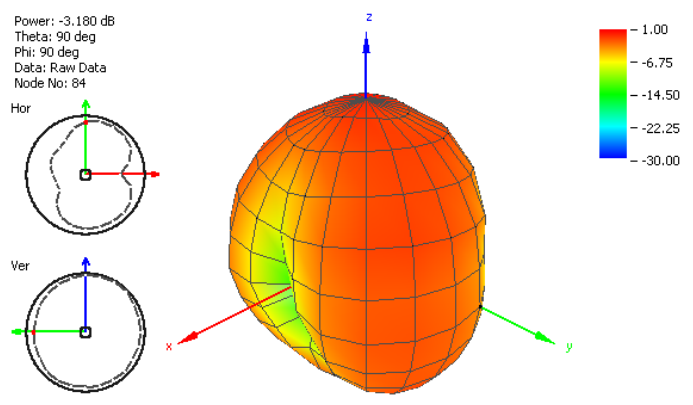

Figure 17. Radiation Pattern at 850 MHz of FXUB70 Port 2.

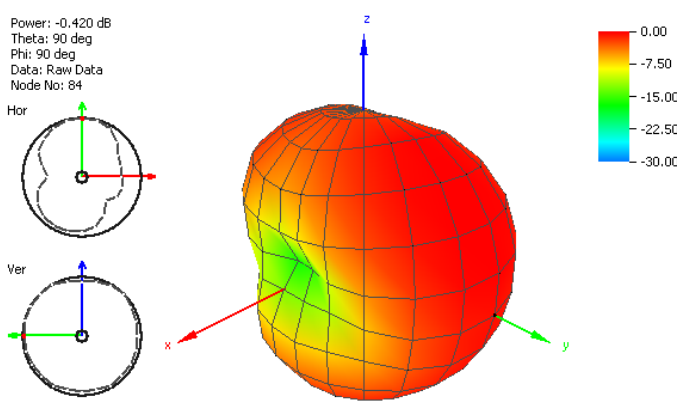

Figure 18. Radiation Pattern at 925 MHz of FXUB70 Port 1.

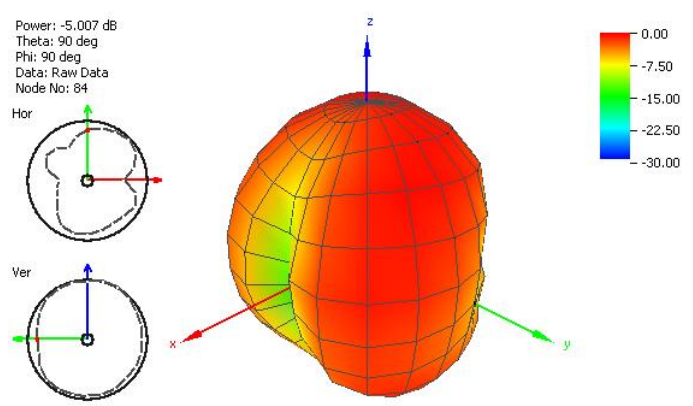

Figure 19. Radiation Pattern at 925 MHz of FXUB70 Port 2.

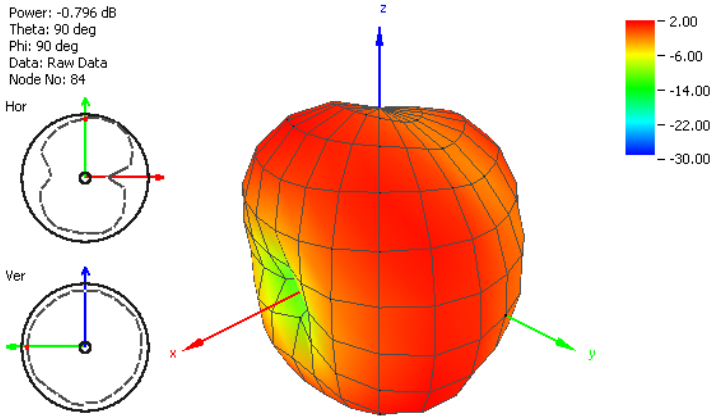

Figure 20. Radiation Pattern at 1575 MHz of FXUB70 Port1

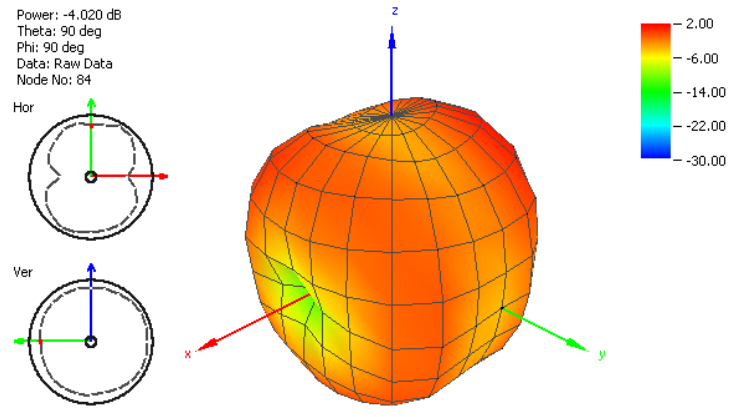

Figure 21. Radiation Pattern at 1575 MHz of FXUB70 Port 2.

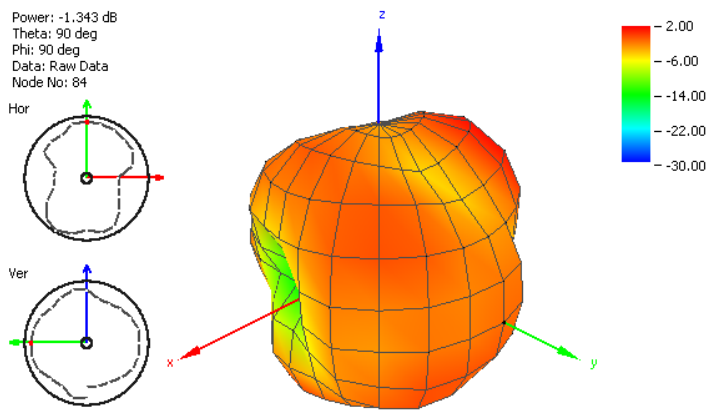

Figure 22. Radiation Pattern at 1750 MHz of FXUB70 Port 1.

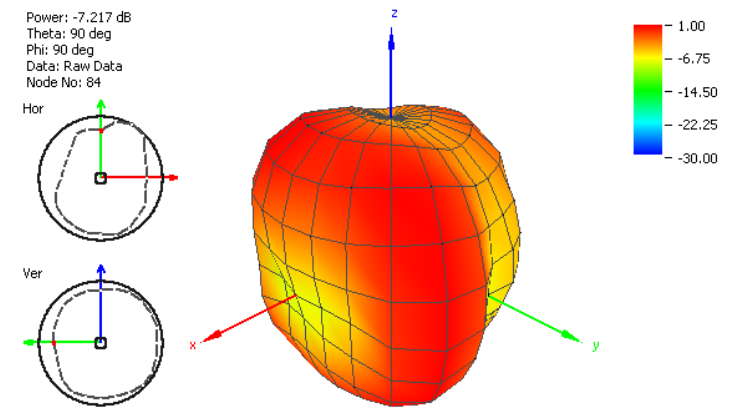

Figure 23. Radiation Pattern at 1750 MHz of FXUB70 Port 2.

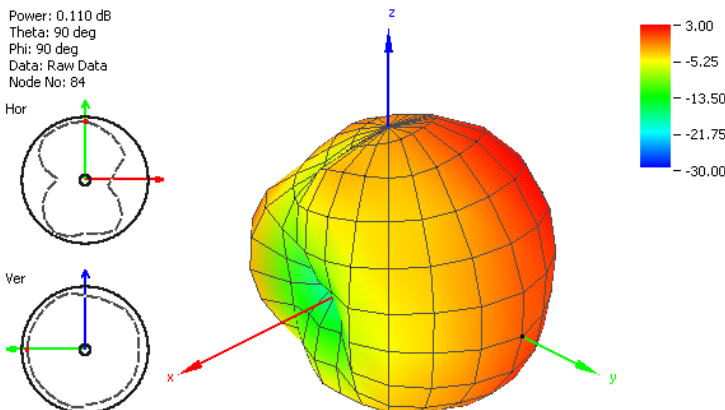

Figure 24. Radiation Pattern at 1850 MHz of FXUB70 Port 1.

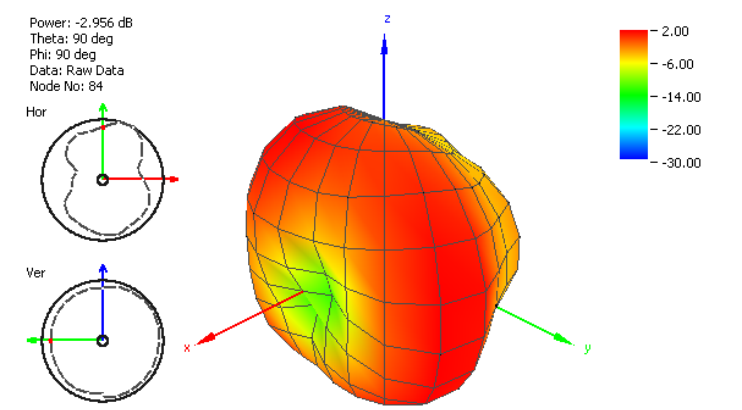

Figure 25. Radiation Pattern at 1850 MHz of FXUB70 Port 2.

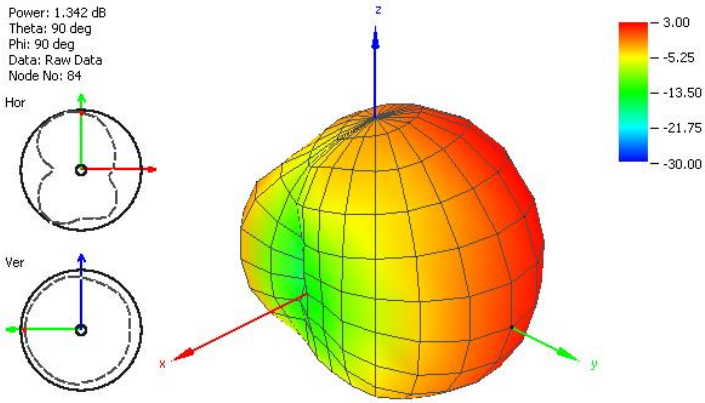

Figure 26. Radiation Pattern at 1950 MHz of FXUB70 Port 1.

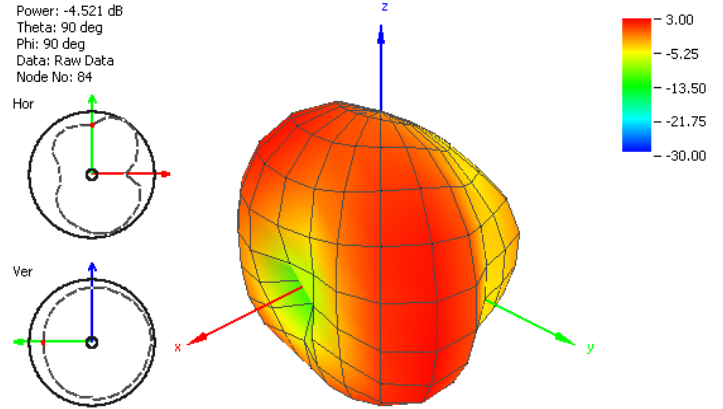

Figure 27. Radiation Pattern at 1950 MHz of FXUB70 Port 2.

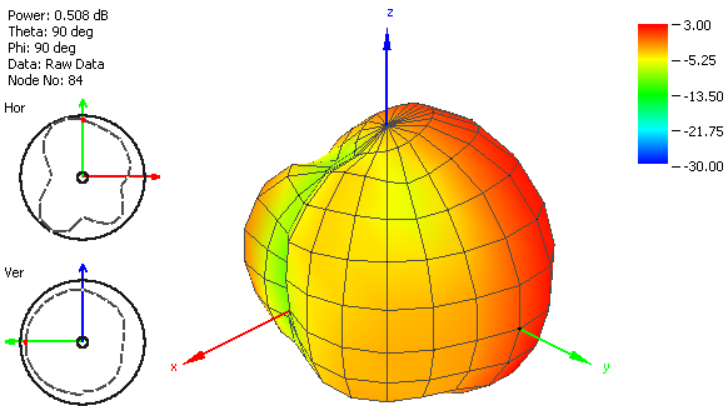

Figure 28. Radiation Pattern at 2100 MHz of FXUB70 Port 1.

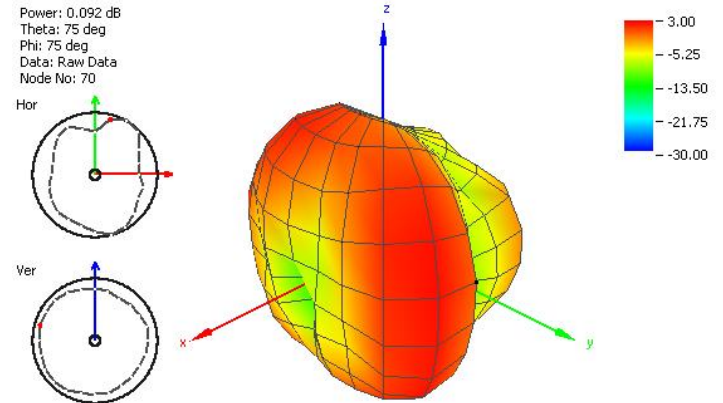

Figure 29. Radiation Pattern at 2100 MHz of FXUB70 Port 2.

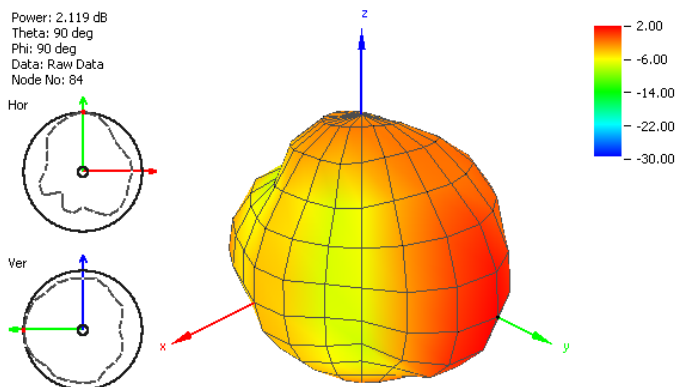

Figure 30. Radiation Pattern at 2450 MHz of FXUB70 Port 1.

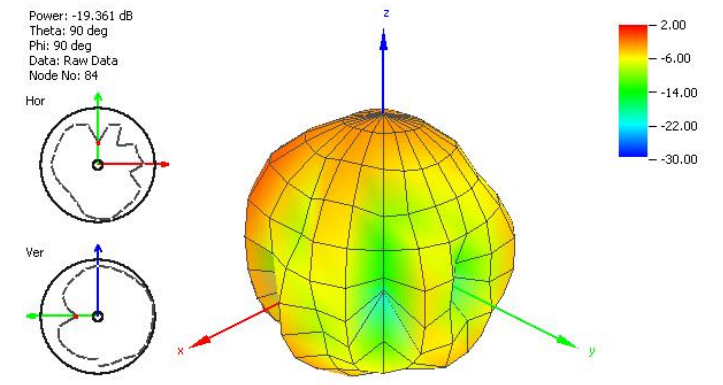

Figure 31. Radiation Pattern at 2450 MHz of FXUB70 Port 2.

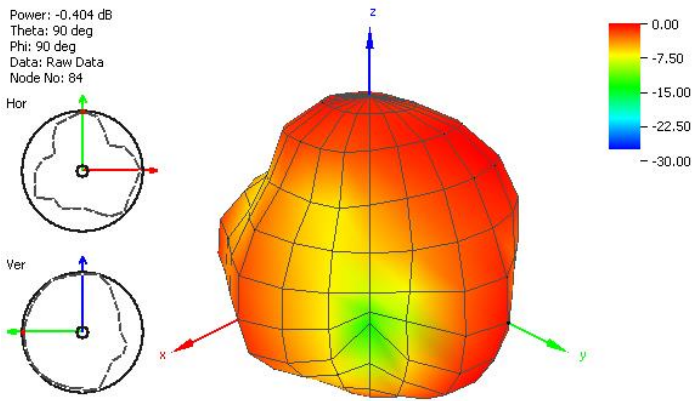

Figure 32. Radiation Pattern at 2600 MHz of FXUB70 Port 1.

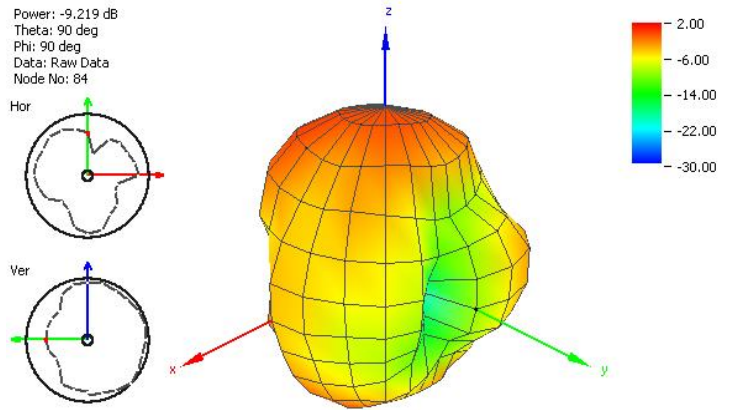

Figure 33. Radiation Pattern at 2600 MHz of FXUB70 Port 2.

4. Mechanical Drawings

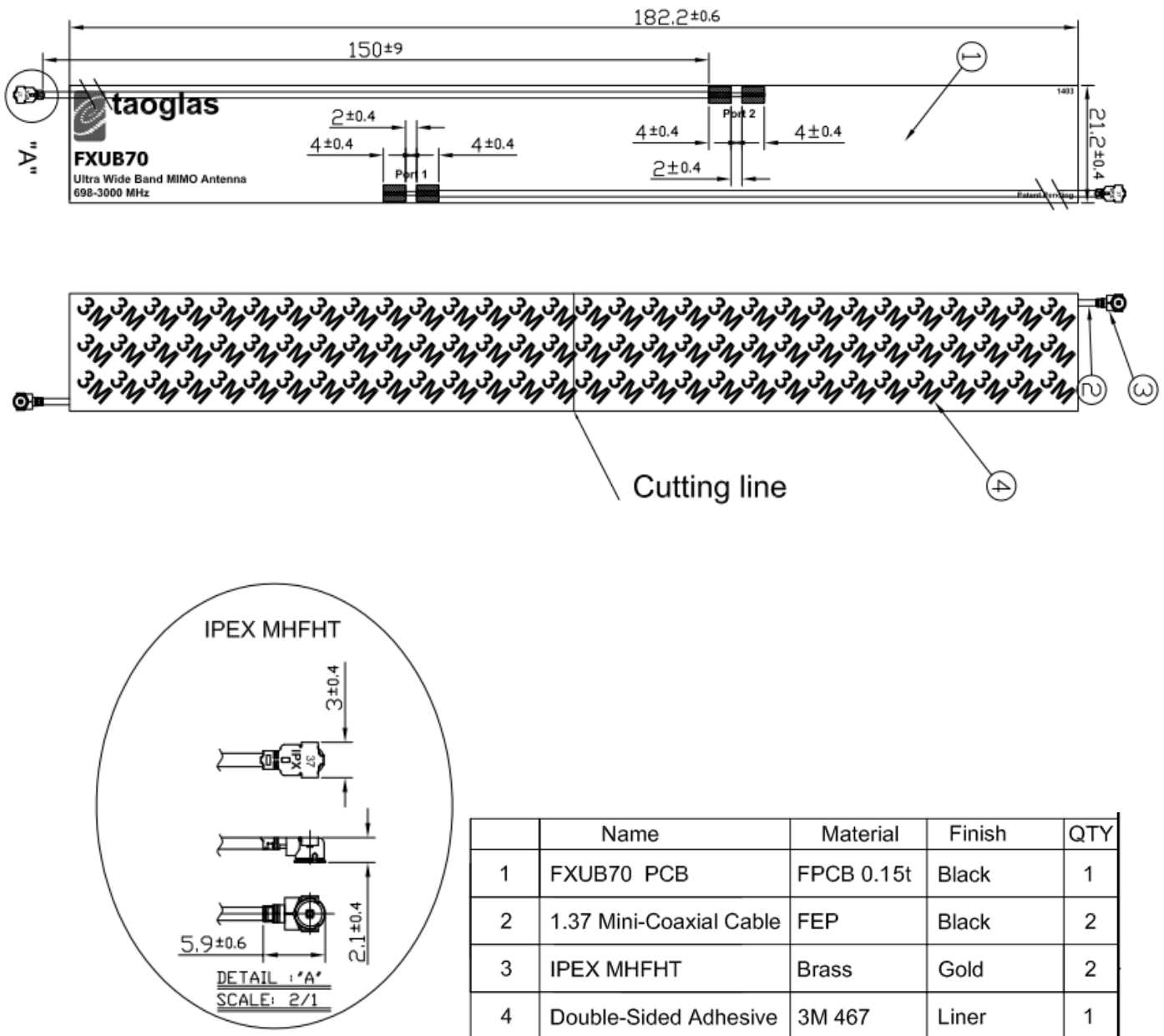
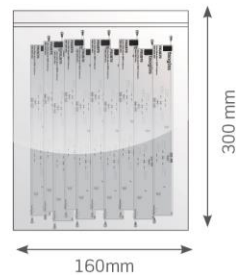

Figure 34. Mechanical drawing of FXUB70 UWB Antenna.

4. Packaging

100pcs FXUB70.A.07.C.001 per PE Bag
 Bag Dimensions - 300 x 160mm
 Weight - 340g



200pcs FXUB70.A.07.C.001 per Large PE Bag
 Bag Dimensions - 450 x 280mm
 Weight - 696g

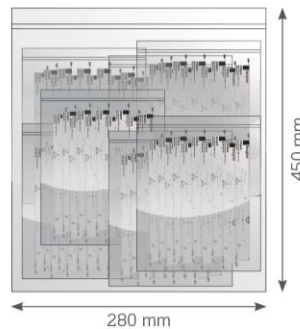

2,000 pcs FXUB70.A.07.C.001 per carton
 Carton - 330 x 250 x 230mm
 Weight - 7Kg

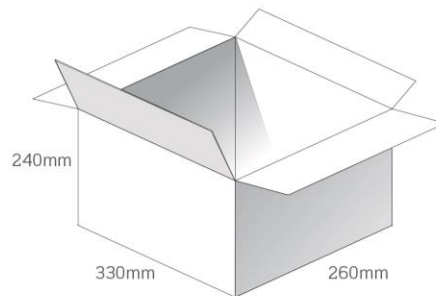

Pallet Dimensions 1200x 1000 x 1350mm
 60 Cartons per Pallet
 12 Cartons per layer
 5 Layers

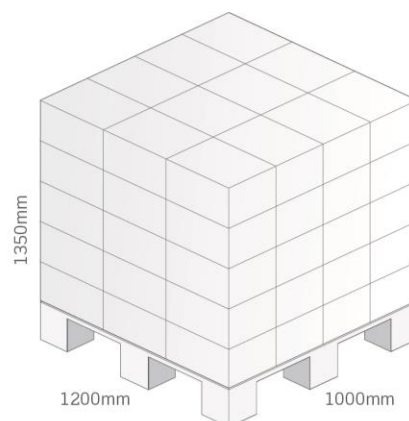

Taoglas makes no warranties based on the accuracy or completeness of the contents of this document and reserves the right to make changes to specifications and product descriptions at any time without notice. Taoglas reserves all rights to this document and the information contained herein.

Reproduction, use or disclosure to third parties without express permission is strictly prohibited.

Copyright © Taoglas Ltd.

X-ON Electronics

Largest Supplier of Electrical and Electronic Components

Click to view similar products for [Antennas](#) category:

Click to view products by [Taoglas](#) manufacturer:

Other Similar products are found below :

[GAN30084EU](#) [930-033-R](#) [GW17.07.0250E](#) [1513563-1](#) [EXE902SM](#) [APAMPG-117](#) [MAF94383](#) [W3908B0100](#) [W6102B0100](#) [YE572113-30RSMM](#) [108-00014-50](#) [66089-2406](#) [A09-F8NF-M](#) [A09-F5NF-M](#) [RGFRA1903041A1T](#) [W3593B0100](#) [W3921B0100](#) [SIMNA-868](#) [SIMNA-915](#) [SIMNA-433](#) [W1044](#) [W1049B090](#) [A75-001](#) [WTL2449CQ1-FRSMM](#) [CPL9C](#) [EXB148BN](#) [0600-00060](#) [TRA9020S3PBN-001](#) [GD5W-28P-NF](#) [MA9-7N](#) [GD53-25](#) [GD5W-21P-NF](#) [C37](#) [MAF94051](#) [MA9-5N](#) [EXD420PL](#) [B1322NR](#) [QWFTB120](#) [MAF94271](#) [MAF94300](#) [GPSMB301](#) [FG4403](#) [AO-AGSM-OM54](#) [5200232](#) [MIKROE-2349](#) [WCM.01.0111](#) [MIKROE-2393](#) [MIKROE-2352](#) [MIKROE-2350](#) [MAF94153](#)