

SPECIFICATION

- Part No. : **GA.110.101111**
- Product Name : 4G/3G/2G High Gain
Magnetic Mount Ultra-Wideband Antenna
- Feature : LTE / GSM / CDMA /DCS /PCS / WCDMA /
UMTS / HSDPA / GPRS / EDGE / GPS / Wi-Fi
698MHz to 960MHz, 1575.42MHz,
1710MHz to 2700MHz, 3500MHz
1m RG174 Cable, SMA(M) Connector
Typical 40% Efficiency and 3dBi Peak Gain
Robust High Strength Super Magnet Mount
Custom cables and connectors available
RoHS Compliant

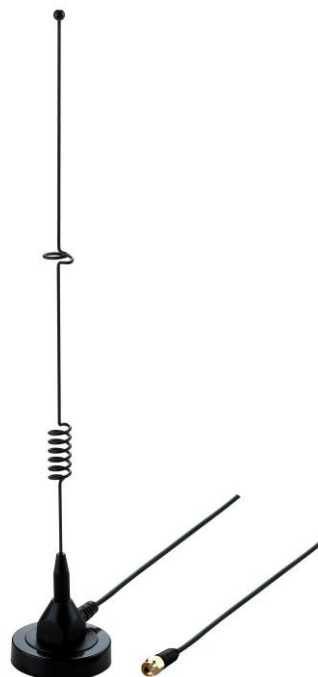

1. Introduction

The GA.110 magnetic ultra-wideband cellular antenna delivers stable high omnidirectional gain and efficiencies across all common 4G, 3G and 2G global cellular bands from 700 MHz to 3.5 GHz.

This high performing antenna can be used for all cellular devices and will not require changing antennas when deploying from country to country or technology to technology like CDMA to GSM or 4G to 3G. Being magnetic mount it is designed to be mounted on a ground plane for optimal performance. A reliable return loss of <10dB when mounted on a metal plate ensures it complies with the industry standards set by module makers and networks worldwide. Taoglas recommends using the antenna with 1m cable length or less and can provide customized connectors and cable lengths upon customer requirements.

The strong magnet base is extremely stable and robust, using only high quality neodymium magnets for a secure magnetic mount to ensure a high pull force to disengage.

2. Specification

ELECTRICAL								
Frequency (MHz)	698~800	824~960	1575.42	1710~1880	1850~1990	1710~2170	2400~2700	3500
Peak Gain (dBi)								
30x30cm GP (1m RG174)	1.8	2.6	1.3	2.5	2.3	3.9	2.9	0.6
30x30cm GP (2m RG174)	-1.0	0.9	0.9	3.9	2.8	2.5	2.2	-0.6
30x30cm GP (3m RG174)	-2.5	-0.1	-1.3	1.2	0.1	1.2	-0.5	-1.6
Average Gain (dBi)								
30x30cm GP (1m RG174)	-4.9	-2.4	-3.4	-2.7	-3.8	-3.3	-4.4	-7.2
30x30cm GP (2m RG174)	-6.3	-3.1	-4.4	-3.9	-4.3	-4.1	-5.4	-5.5
30x30cm GP (3m RG174)	-7.2	-4.4	-6.2	-5.5	-6.3	-6.1	-7.4	-8.9
Efficiency (%)								
30x30cm GP (1m RG174)	33.6	57.1	46.2	55.0	41.8	47.8	36.9	19.0
30x30cm GP (2m RG174)	23.9	48.7	36.5	41.3	37.3	39.5	29.0	28.0
30x30cm GP (3m RG174)	19.7	36.2	24.0	28.5	21.8	25.0	19.0	13.0
Impedance	50Ω							
Polarization	Linear							
Radiation Pattern	Omni							
Input Power	50 W							

MECHANICAL	
Base Diameter	50mm
Whip Diameter	298mm
Whip Material	Coated Brass
Connector	SMA Male
ENVIRONMENTAL	
Temperature Range	-40°C to 85°C
Humidity	Non-condensing 65°C 95% RH

LTE BANDS			
Band Number	LTE / LTE-Advanced / WCDMA / HSPA / HSPA+ / TD-SCDMA		
	Uplink	Downlink	Covered
1	UL: 1920 to 1980	DL: 2110 to 2170	✓
2	UL: 1850 to 1910	DL: 1930 to 1990	✓
3	UL: 1710 to 1785	DL: 1805 to 1880	✓
4	UL: 1710 to 1755	DL: 2110 to 2155	✓
5	UL: 824 to 849	DL: 869 to 894	✓
7	UL: 2500 to 2570	DL: 2620 to 2690	✓
8	UL: 880 to 915	DL: 925 to 960	✓
9	UL: 1749.9 to 1784.9	DL: 1844.9 to 1879.9	✓
11	UL: 1427.9 to 1447.9	DL: 1475.9 to 1495.9	✗
12	UL: 699 to 716	DL: 729 to 746	✓
13	UL: 777 to 787	DL: 746 to 756	✓
14	UL: 788 to 798	DL: 758 to 768	✓
17	UL: 704 to 716	DL: 734 to 746 (LTE only)	✓
18	UL: 815 to 830	DL: 860 to 875 (LET only)	✓
19	UL: 830 to 845	DL: 875 to 890	✓
20	UL: 832 to 862	DL: 791 to 821	✓
21	UL: 1447.9 to 1462.9	DL: 1495.9 to 1510.9	✗
22	UL: 3410 to 3490	DL: 3510 to 3590	✗
23	UL: 2000 to 2020	DL: 2180 to 2200 (LTE only)	✓
24	UL: 1625.5 to 1660.5	DL: 1525 to 1559 (LTE only)	✓
25	UL: 1850 to 1915	DL: 1930 to 1995	✓
26	UL: 814 to 849	DL: 859 to 894	✓
27	UL: 807 to 824	DL: 852 to 869 (LTE only)	✓
28	UL: 703 to 748	DL: 758 to 803 (LTE only)	✓
29	UL: -	DL: 717 to 728 (LTE only)	✓
30	UL: 2305 to 2315	DL: 2350 to 2360 (LTE only)	✓
31	UL: 452.5 to 457.5	DL: 462.5 to 467.5 (LTE only)	✗
32	UL: -	DL: 1452 - 1496	✗
35		1850 to 1910	✓
38		2570 to 2620	✓
39		1880 to 1920	✓
40		2300 to 2400	✓
41		2496 to 2690	✓
42		3400 to 3600	✗
43		3600 to 3800	✗

3. Antenna Characteristics

3.1. Return Loss

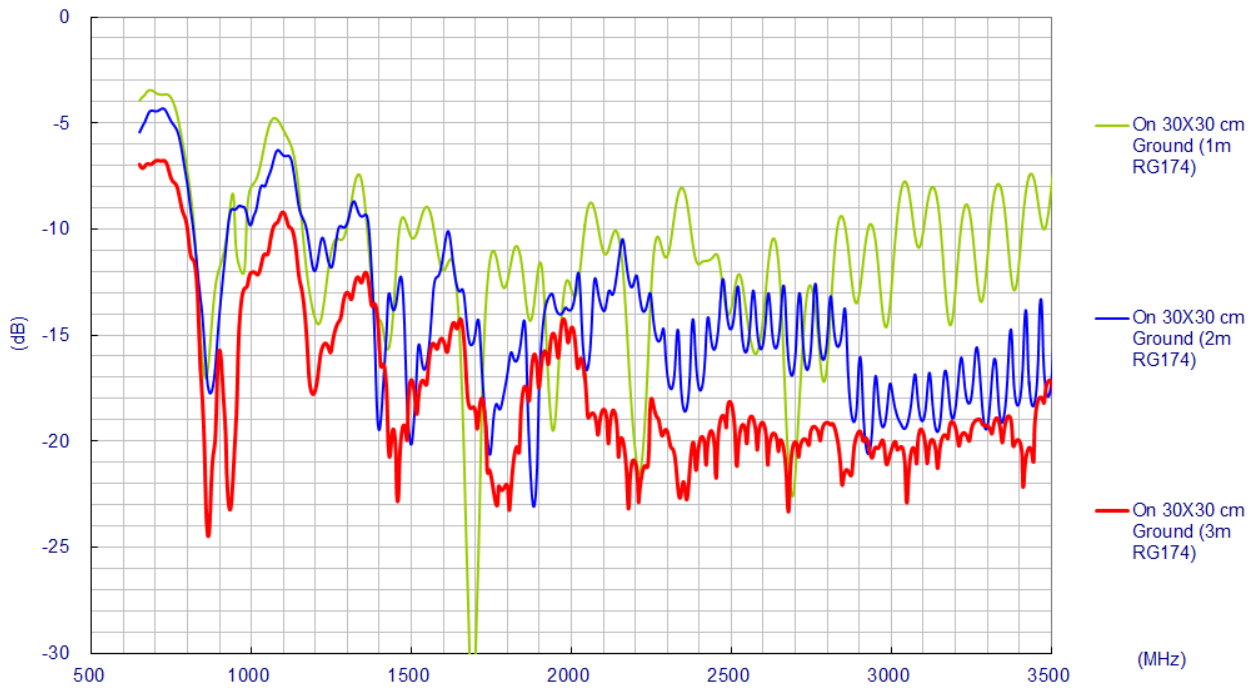

3.2. Maximum Gain

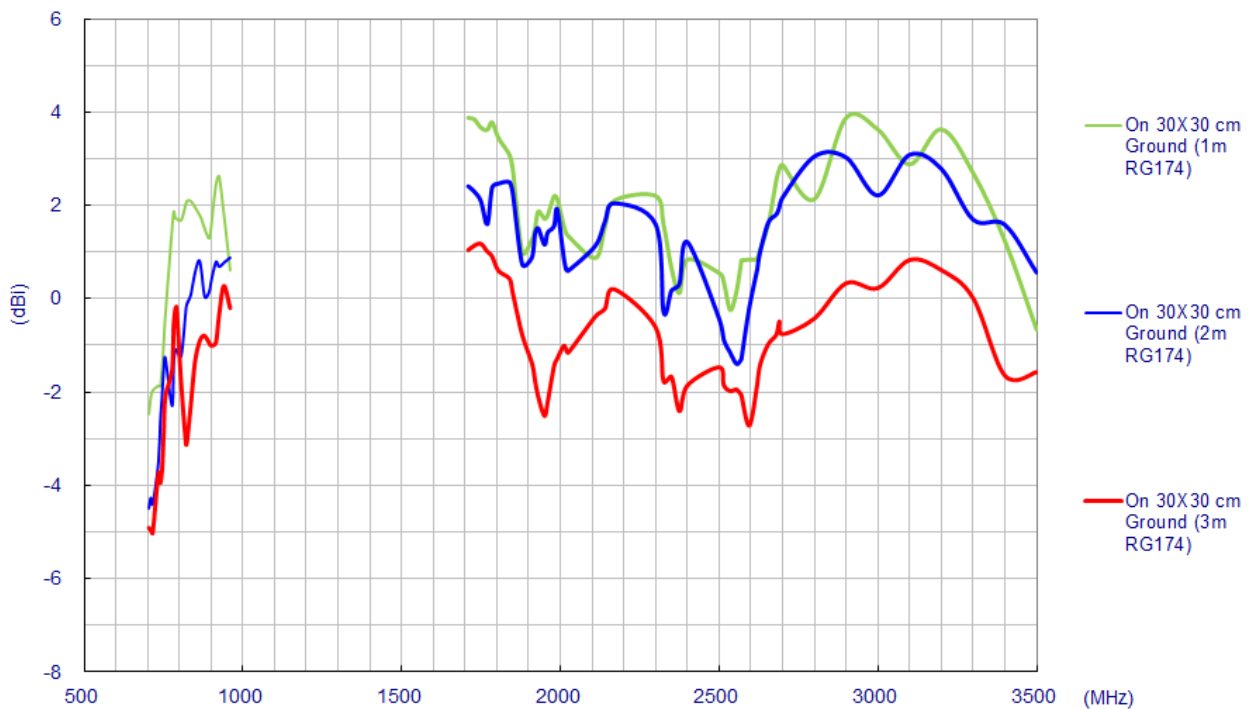

3.3. Average Gain

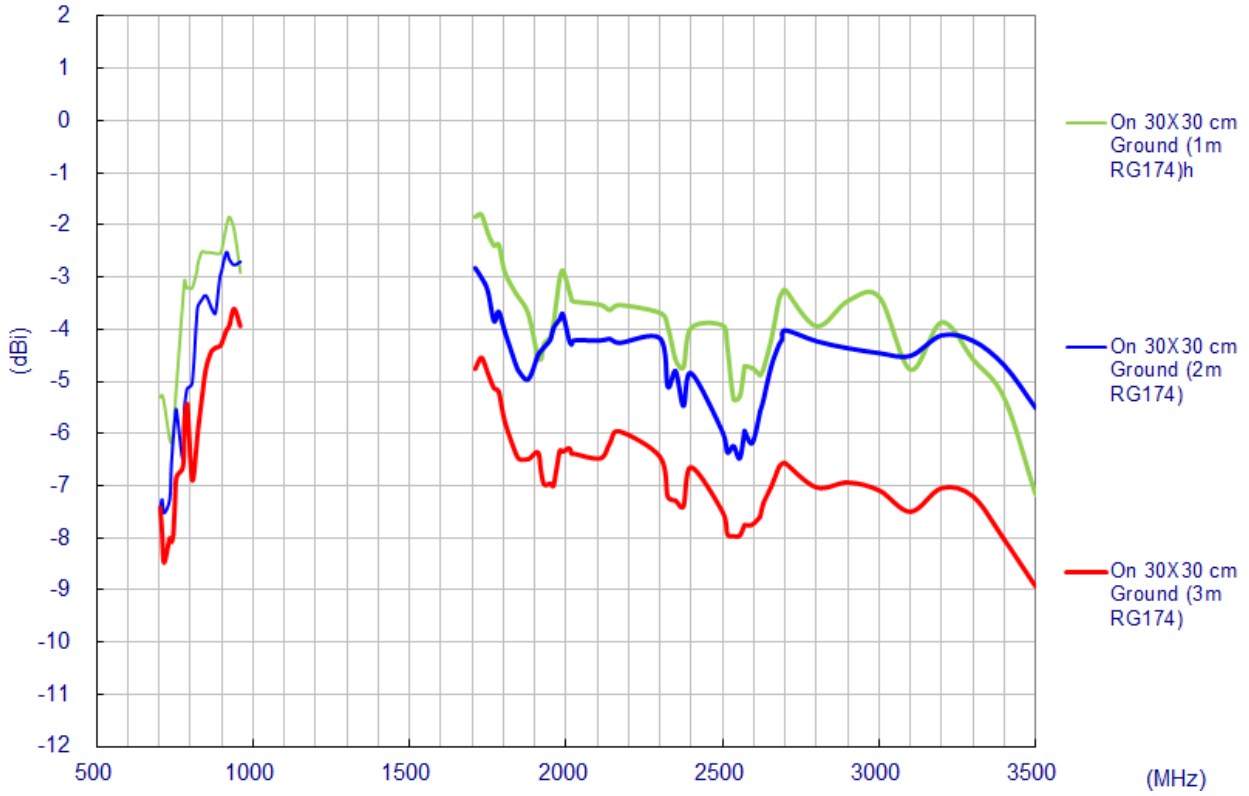

3.4. Efficiency

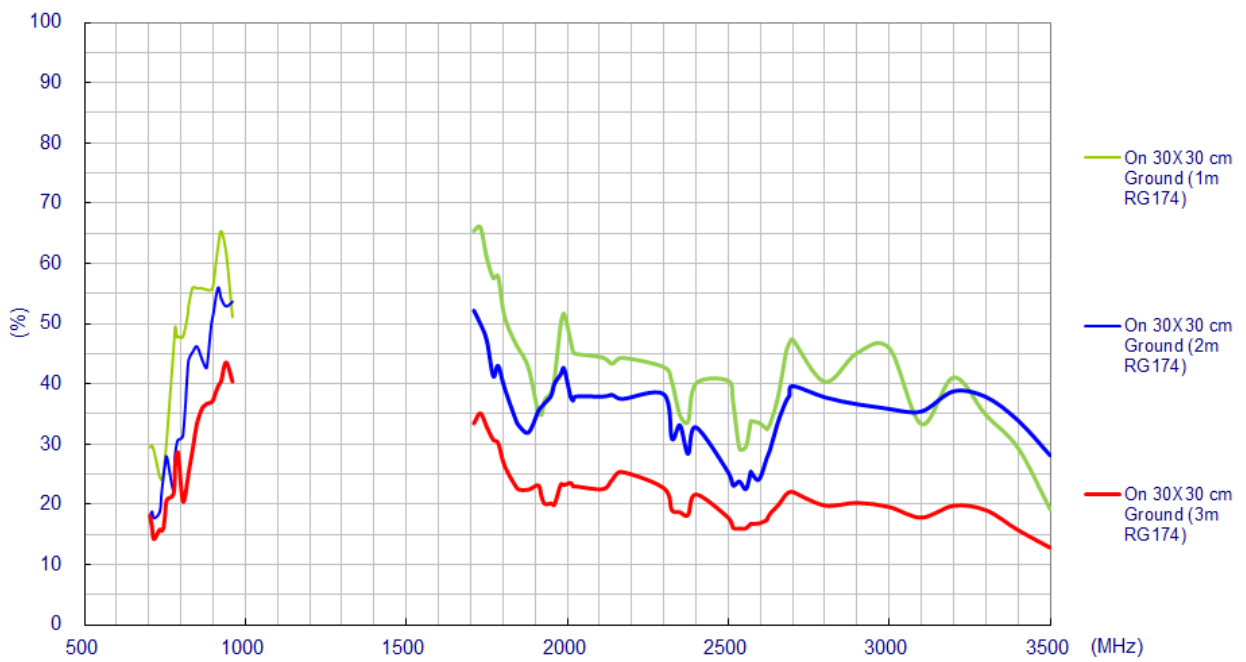

4. Antenna Radiation Patterns

4.1. Antenna setup (On 300x300mm ground plane with 1m RG174 cable)

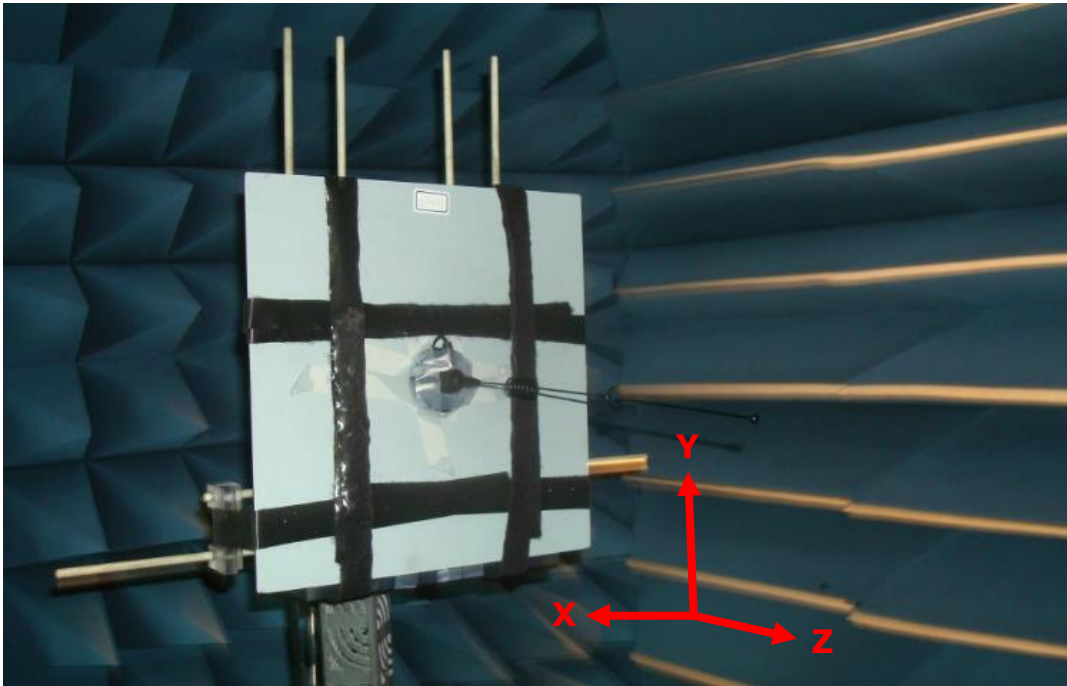

4.2. Radiation Patterns

XY Plane

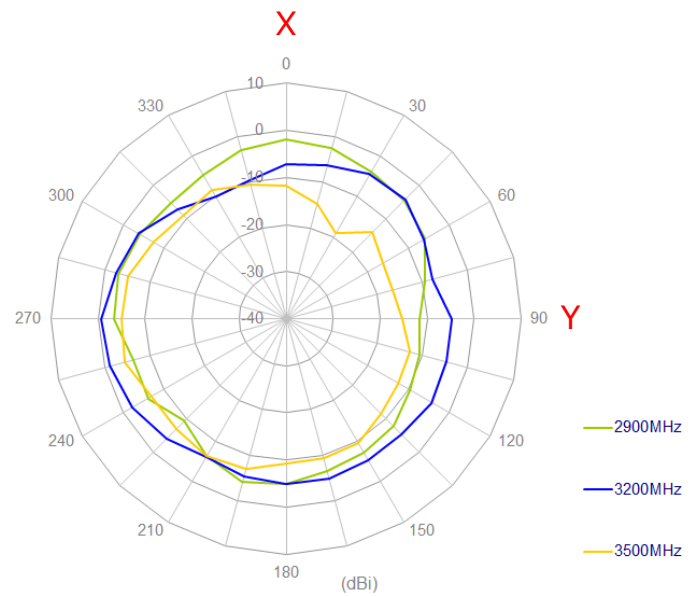
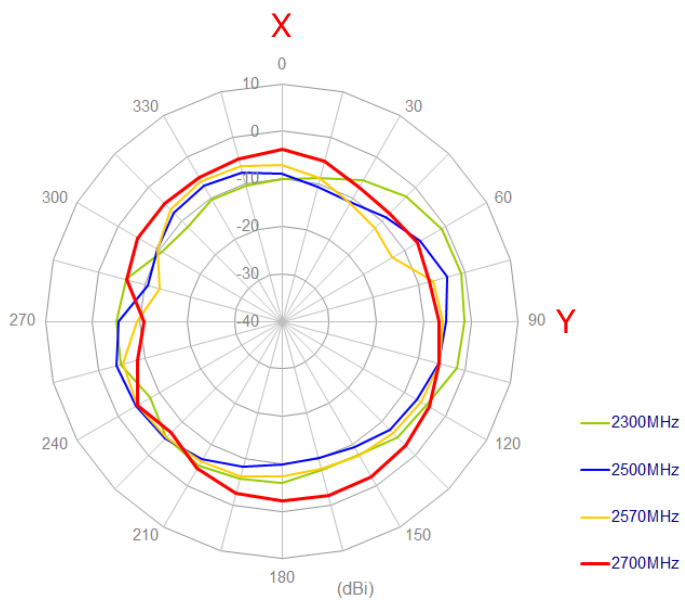
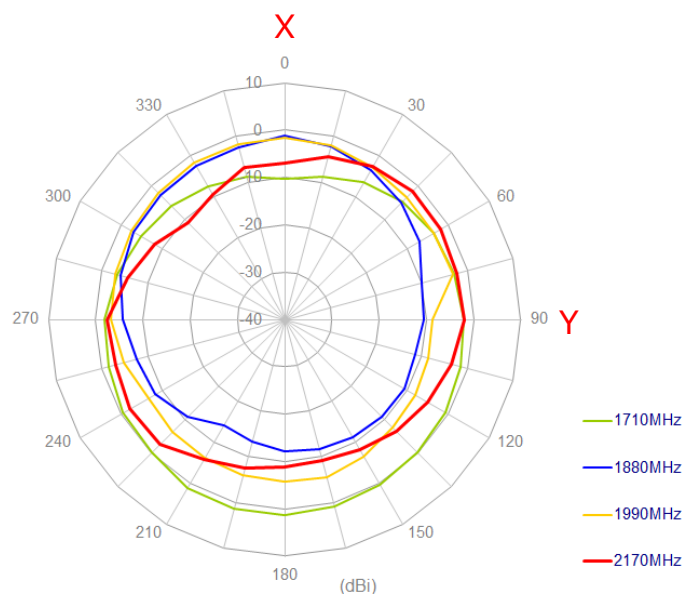
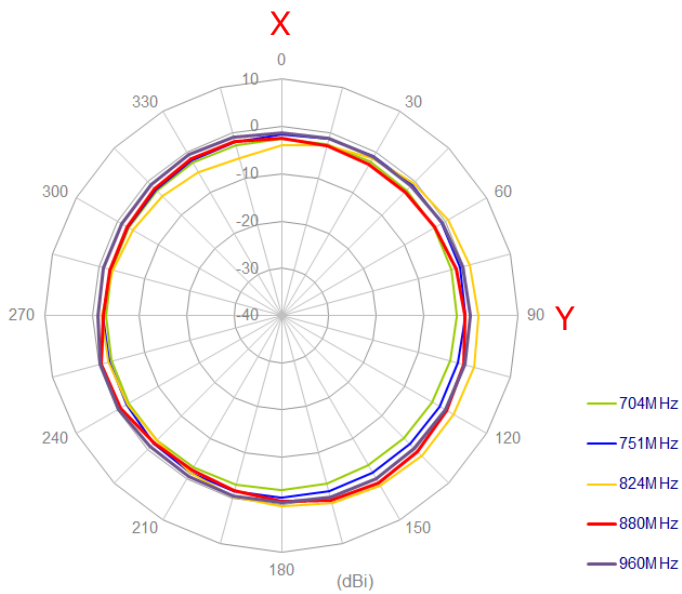

XZ Plane

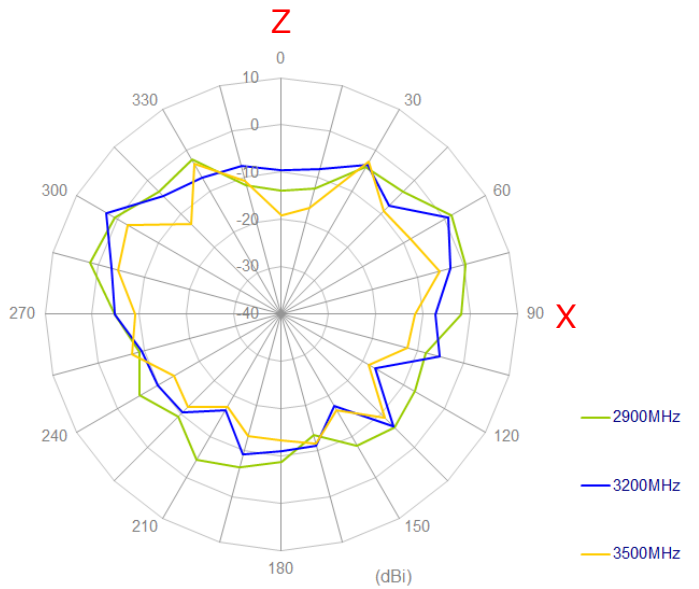
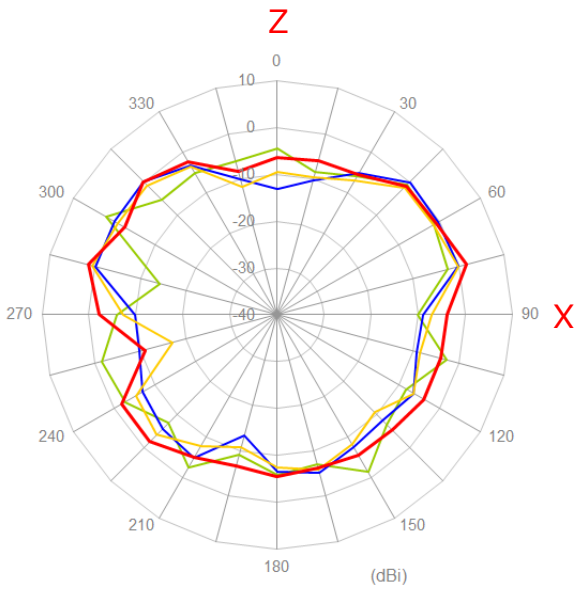
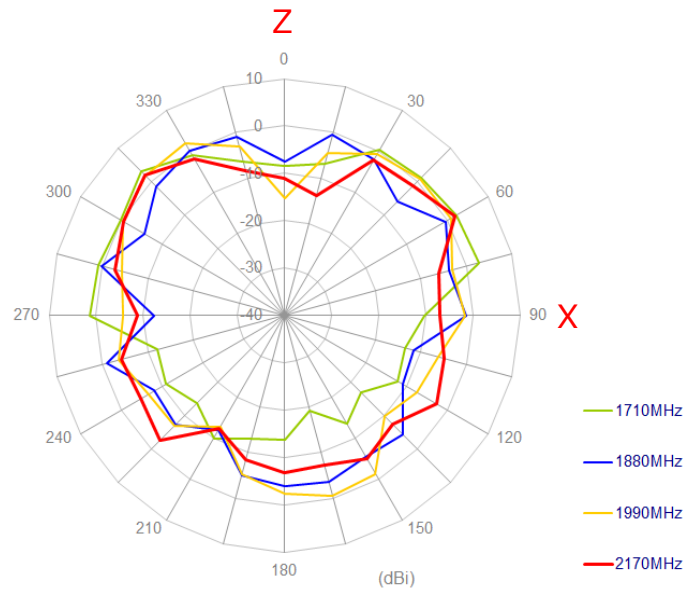
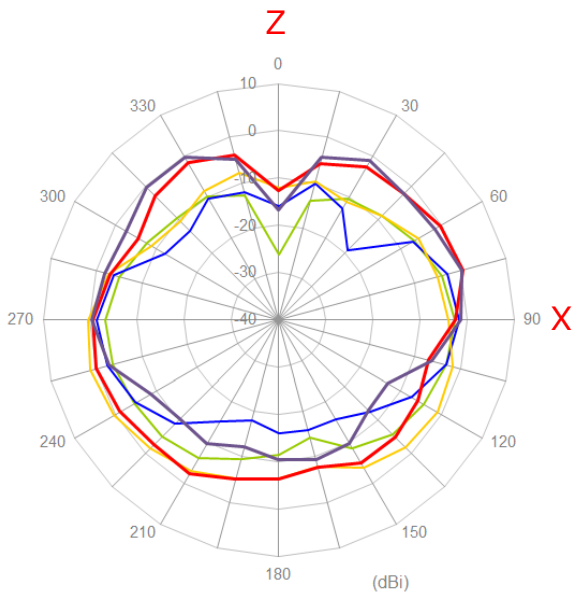

5. Mechanical Drawing

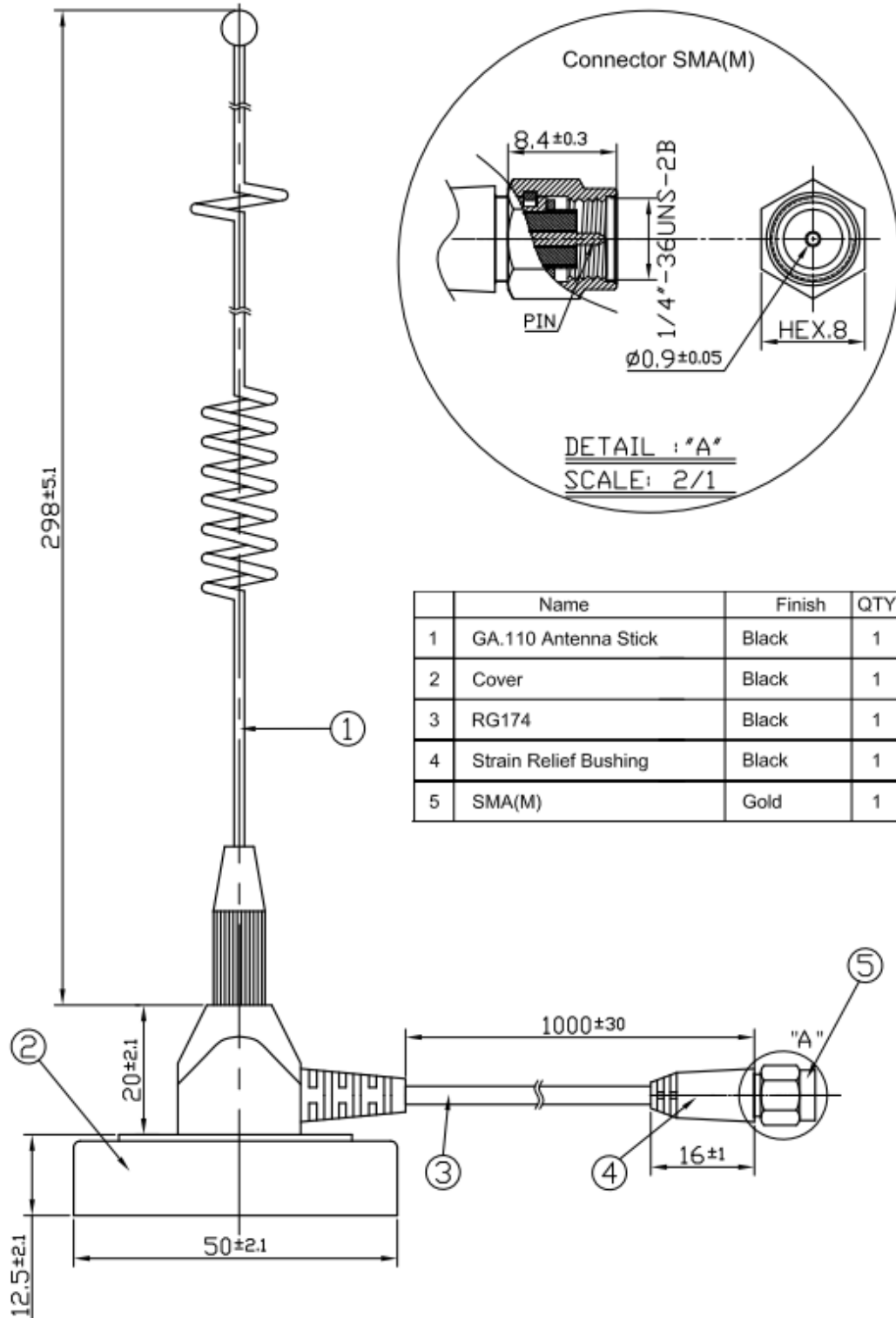



Taoglas makes no warranties based on the accuracy or completeness of the contents of this document and reserves the right to make changes to specifications and product descriptions at any time without notice. Taoglas reserves all rights to this document and the information contained herein.

Reproduction, use or disclosure to third parties without express permission is strictly prohibited.

Copyright © Taoglas Ltd.

X-ON Electronics

Largest Supplier of Electrical and Electronic Components

Click to view similar products for [Antennas](#) category:

Click to view products by [Taoglas](#) manufacturer:

Other Similar products are found below :

[GAN30084EU](#) [930-033-R](#) [GW17.07.0250E](#) [1513563-1](#) [EXE902SM](#) [APAMPG-117](#) [MAF94383](#) [W3908B0100](#) [W6102B0100](#) [YE572113-30RSMM](#) [108-00014-50](#) [66089-2406](#) [SPDA17RP918](#) [A09-F8NF-M](#) [A09-F5NF-M](#) [RGFRA1903041A1T](#) [W3593B0100](#) [W3921B0100](#) [SIMNA-868](#) [SIMNA-915](#) [SIMNA-433](#) [W1044](#) [W1049B090](#) [A75-001](#) [WTL2449CQ1-FRSMM](#) [CPL9C](#) [EXB148BN](#) [0600-00060](#) [TRA9020S3PBN-001](#) [Y4503](#) [GD5W-28P-NF](#) [MA9-7N](#) [GD53-25](#) [GD5W-21P-NF](#) [C37](#) [MAF94051](#) [MA9-5N](#) [EXD420PL](#) [B1322NR](#) [QWFTB120](#) [MAF94271](#) [MAF94300](#) [GPSMB301](#) [FG4403](#) [AO-AGSM-OM54](#) [5200232](#) [MIKROE-2349](#) [WCM.01.0111](#) [MIKROE-2393](#) [MIKROE-2352](#)