

Specification

Part No.	:	GLA.01
Model	:	2.5dBi 1575.42MHz GPS/GALILEO Loop Antenna
Description	:	1575.42MHz
Features	:	L=5mm*W=3mm*H=0.5mm Low profile SMT antenna High performance Loop antenna RoHS Compliant



1. Introduction

Taoglas has developed a unique ceramic miniature loop antenna series for GPS/GALILEO applications. At 5.0*3.0*0.5mm, the GLA.01 GPS/GALILEO Loop antenna is a miniature edge mounted antenna designed for small space requirements. The radiation pattern is more omni-directional than traditional patch antennas. The GLA loop antenna series show at least three times the efficiency of traditional linear polarized 1575.42MHz MHz antennas. Efficiencies of 40% to 90% are achievable. A peak gain of 2.5dBi places this antenna's gain performance within the range of a much larger 15mm to 18mm patch antenna.

Mechanically, the GLA.01 at only 0.5mm in height has a very low profile, and with a footprint of 6.0 x 5.5mm needs less space on the board. It does require clearance of 6.0 x 5.5mm. Based on the loop effect, this antenna works best when placed on the center of the edge of the board, but can still work better than traditional linear polarized chip antennas even when placed at corners as a substitute.

The GLA.01 is delivered on tape and reel and now allows M2M customers to use an omni-directional antenna in devices where orientation of the product is unknown.

1.1. Applications

*Navigation or position tracking systems

*Hand-held devices when GPS/GALILEO function is needed, e.g., smart phone. PDA

2. Key Performance Indicators

The antenna performance was measured with the GLA.01 mounted on an evaluation board (80*40mm ground plane with SMA female connector)

No	Parameter	Specification*
1	Center Frequency	1575.42MHz**
2	Dimensions	5.0*3.0*0.5mm
3	VSWR	2 max
4	Polarization	Linear
5	Bandwidth	50MHz Min.
6	Gain	Peak 2.5dBi typ.
7	Efficiency	84% typ.
8	Impedance	50 Ω
Mechanical		
9	Dimensions	5*3*0.5mm
10	Material	Ceramic
Environmental		
11	Operating Temperature	-40°C~+85°C
12	Storage Temperature	-40°C~+105°C
13	Temperature Coefficient (τf)	0 ± 20 ppm @-20°C to +80°C
14	Recommended Reel Storage	5°C to 40°C
	Condition	Relative Humidity 20% to 70%

* The data was measured by A CTIA Authorized Test Lab.

** Working frequency will be offset to another frequency according to the conditions of user's ground plane and radome.



3. Electrical Characteristics (80*40mm ground plane)

3.1. Return Loss (S11)

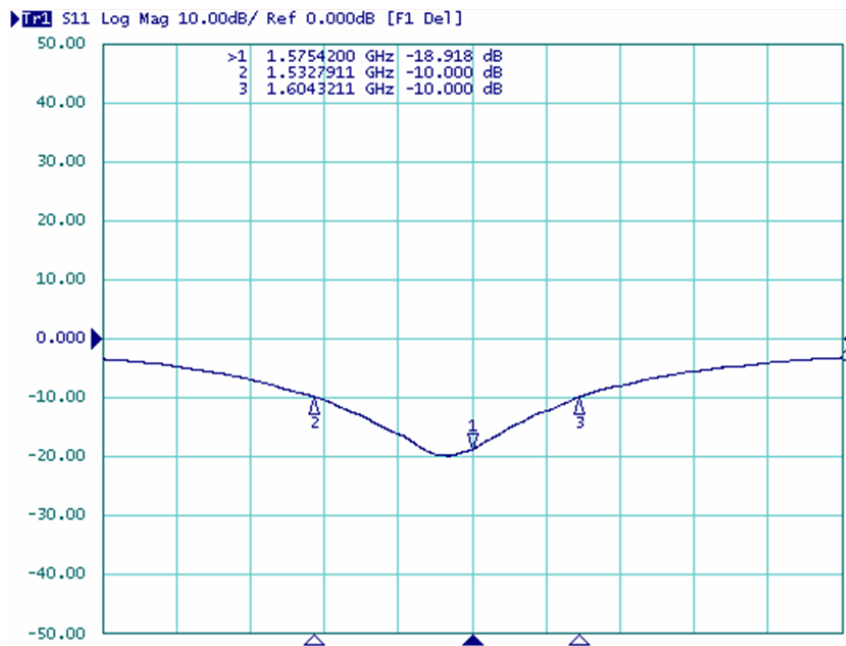

3.2. Impedance (Smith Chart)

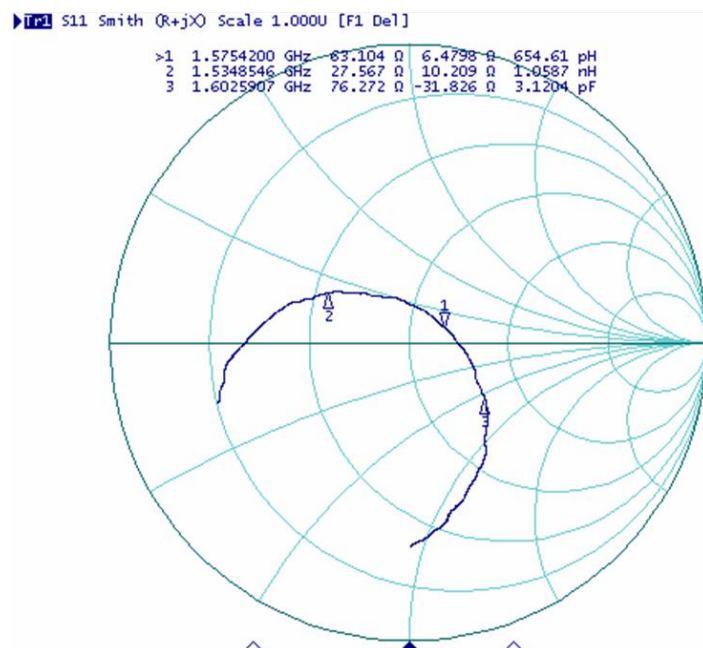

4. Radiation Pattern (Customize Design)

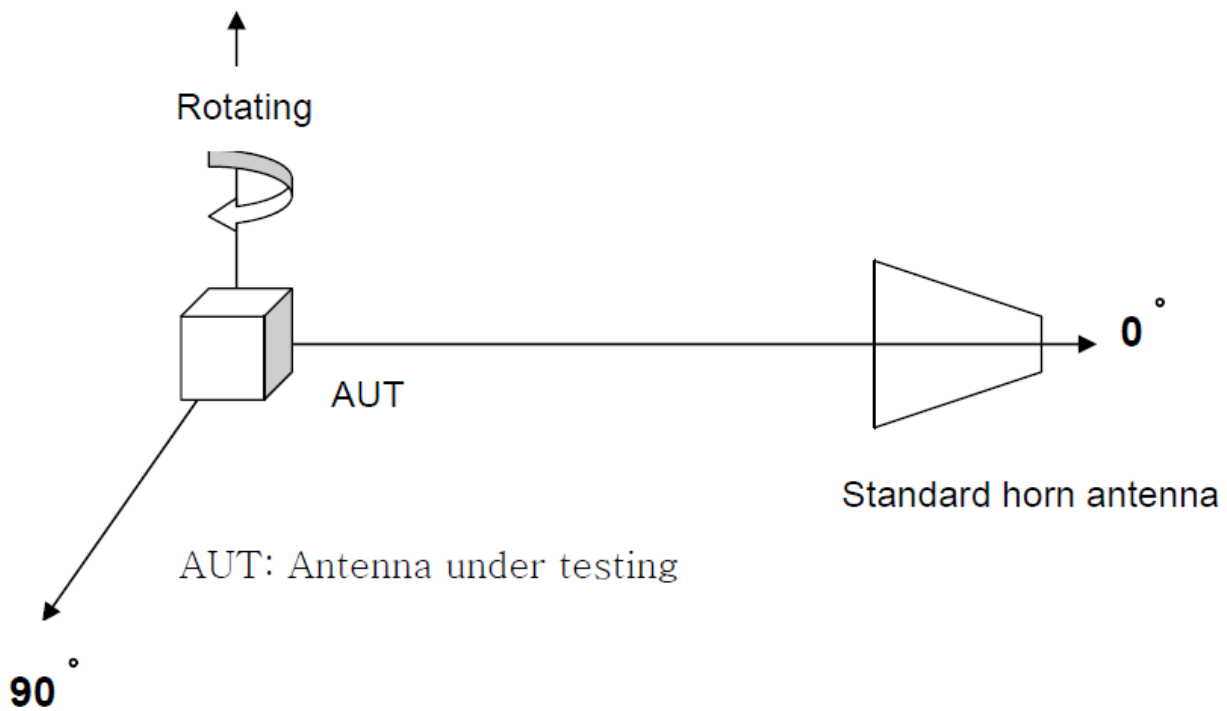

4.1. Radiation Pattern (80X40(mm)ground plane)

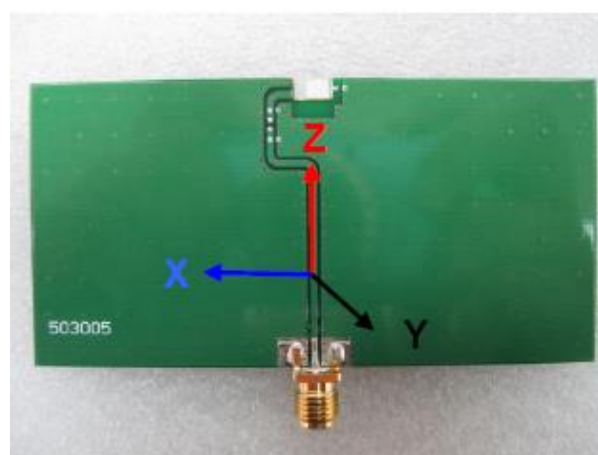



4.2. 3D Gain Pattern @1575 MHz

Azimuth = 180.0
Elevation = 0.0
Roll = -180.0

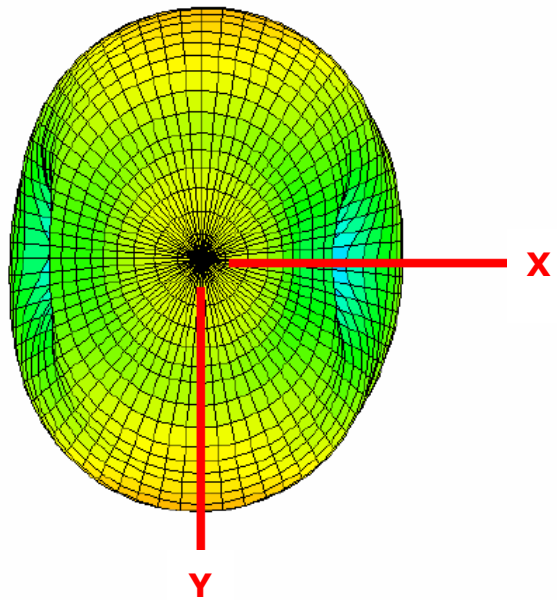

Azimuth = 180.0
Elevation = 0.0
Roll = -180.0

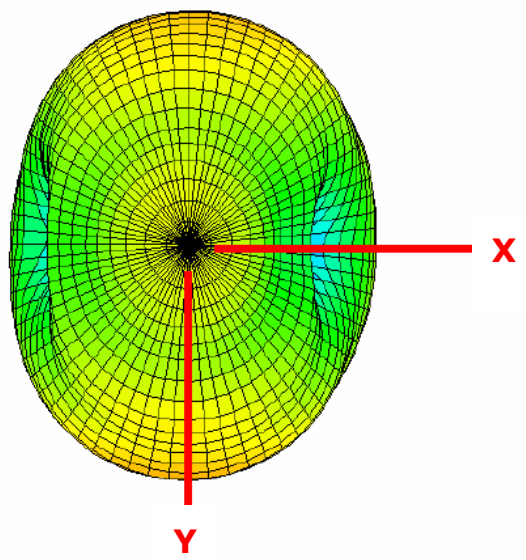



Azimuth = 90.0
Elevation = 0.0
Roll = 180.0

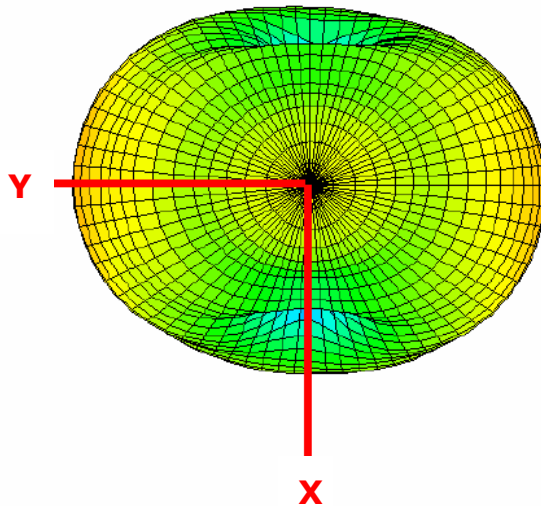

Azimuth = 90.0
Elevation = 0.0
Roll = -90.0

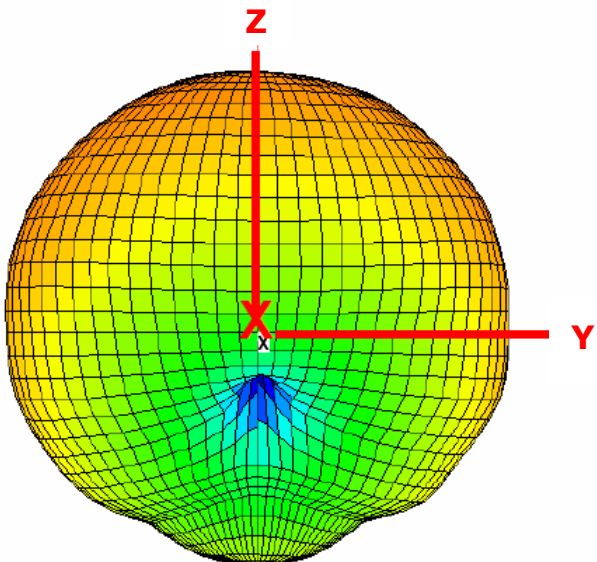

4.3. Efficiency Table

Frequency(MHz)	1570	1571	1572	1573	1574	1575	1576	1577	1578	1579	1580
Efficiency (dB)	-0.86	-0.86	-0.85	-0.83	-0.82	-0.80	-0.78	-0.76	-0.76	-0.75	-0.74
Efficiency (%)	82.00	82.03	82.21	82.61	82.70	83.15	83.60	83.95	84.03	84.18	84.28
Gain (dBi)	2.41	2.41	2.42	2.44	2.44	2.48	2.51	2.51	2.52	2.53	2.55

4.4. Efficiency vs. Frequency

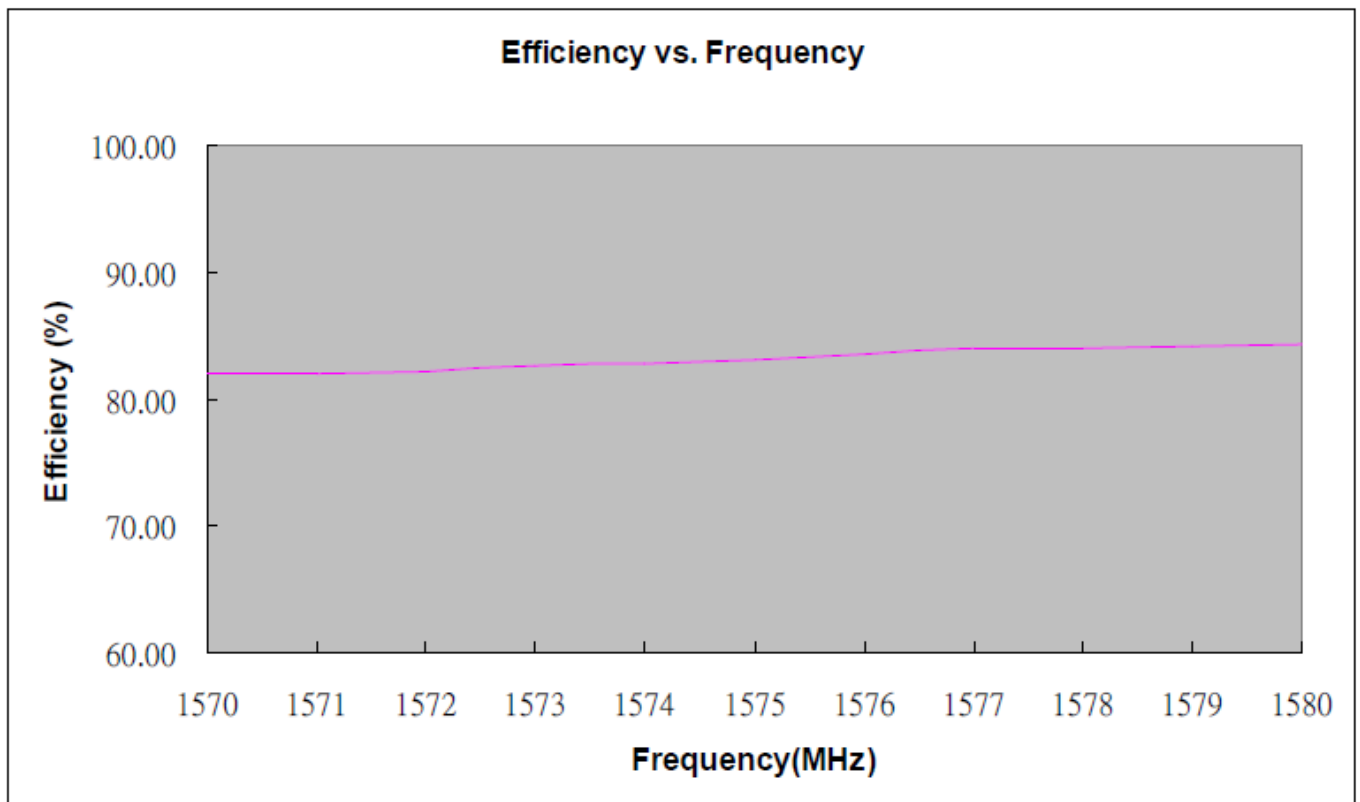



5. Layout Guide

5.1. Solder Land pattern

The land pattern for soldering (grey marked areas) is as shown below. A matching circuit similar to the one shown in Section 5.3 is also required.

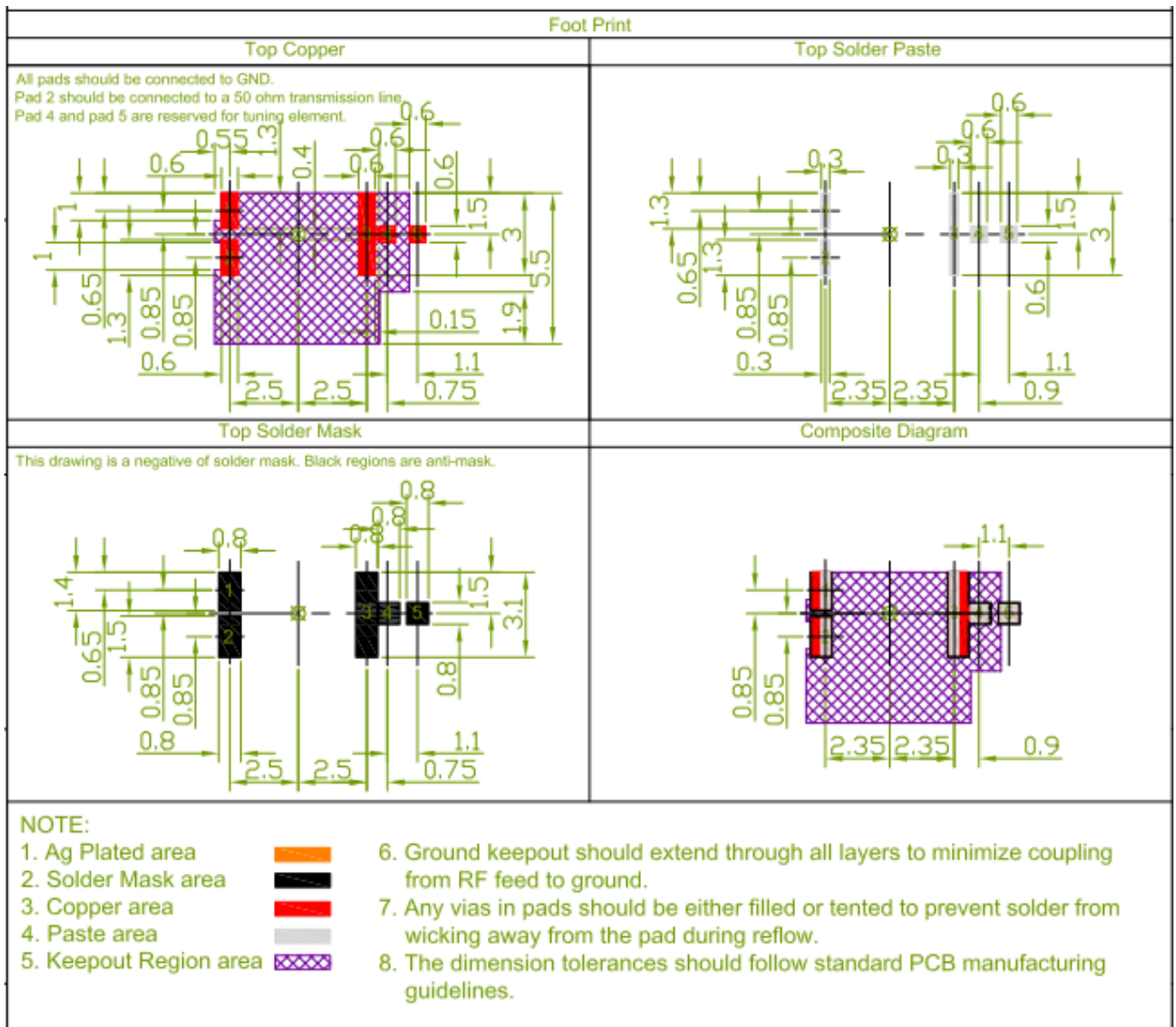

5.2. Fine Tuning Element vs. Centre Frequency

This antenna includes a fine tuning element (as shown in the land patterns above) that can be used to slightly shift antenna resonance.

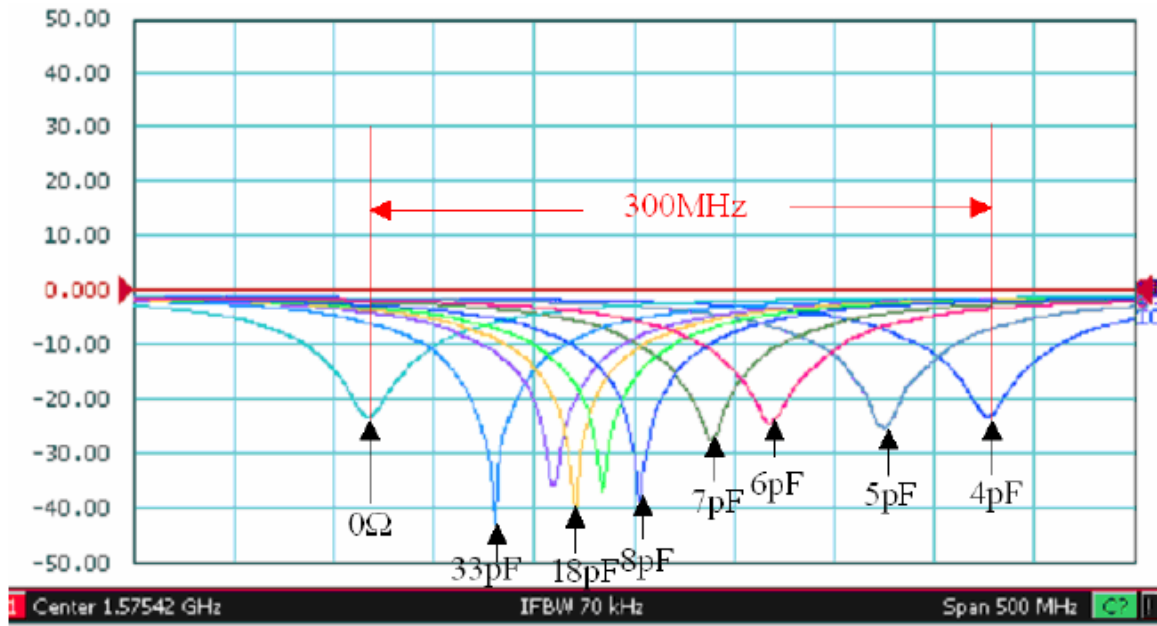

5.3. Matching Circuit

Like all antennas, surrounding components, enclosures, and changes to the GND plane dimensions can alter performance. A pi-matching network like the one shown below is required in case adjustments need to be made. The antenna EVB has a similar matching network. The components on the EVB are a good starting point for a new design, but will need to be adjusted upon integration for best performance. The zero ohm resistor is needed for the ability to solder down a coax pigtail to make measurements with a vector network analyzer.

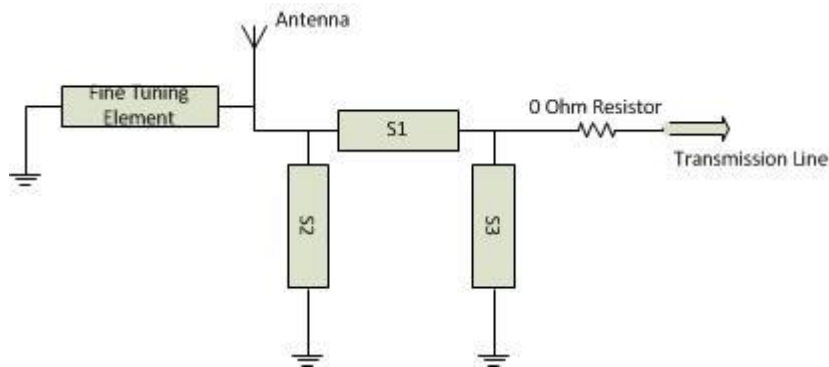

6. Antenna Drawings

6.1. Antenna Main Body

Top View



Side View

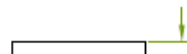

Bottom View



NOTE:

1. Ag Plated area





6.2. Antenna with EVB

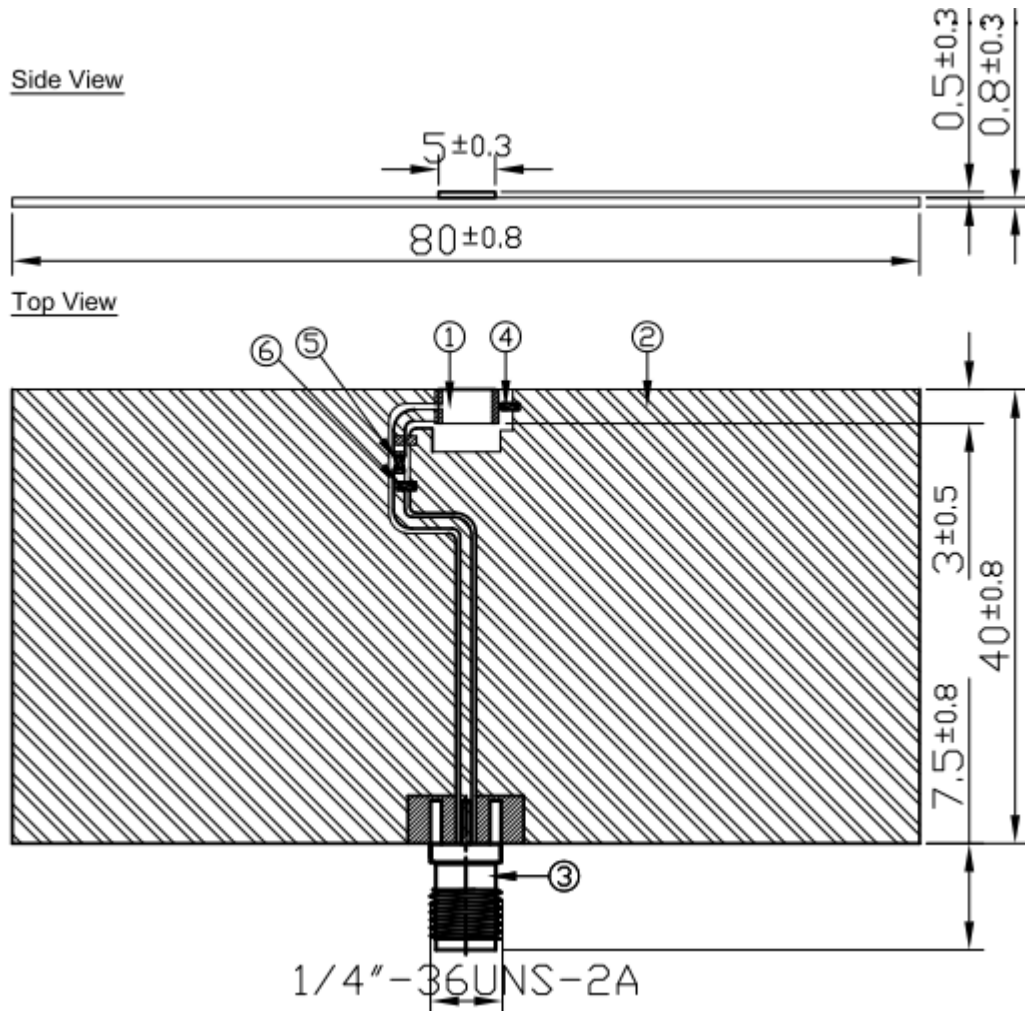

	Name	Material	Finish	QTY
1	GLA.01 Antenna	Ceramlc	N/A	1
2	GLAD.01 EVB Board	FR4 0,8t	Green	1
3	SMA(F) ST	Brass	Gold	1
4	Capacltor 8pF (0402)	Ceramlc	N/A	1
5	Reslstor 0Ω (0402)	Ceramlc	N/A	1
6	Capacltor 2.2pF (0402)	Ceramlc	N/A	1

- NOTES:
1. Solder Area
 2. Logo & Text Ink Printing : Black
 3. Copper
 4. Matching Component
 5. Component 6 is the tuning element of this antenna.



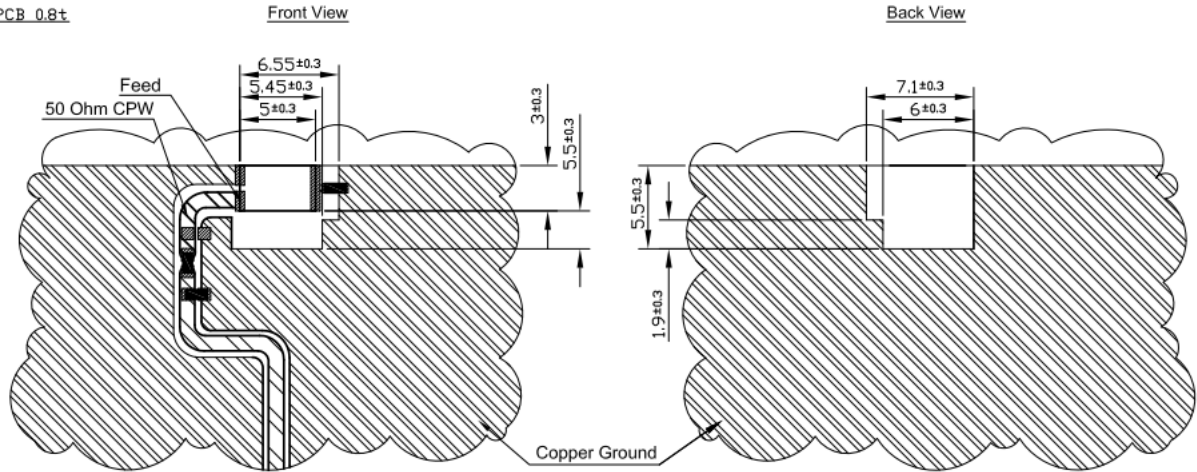

6.3. Footprint on EVB

FR4 PCB 0.8±



NOTES:

- 1. Solder Area 
- 2. Logo & Text Ink Printing : Black
- 3.  Copper
- 4.  Matching Component
- 5. Component 6 is the tuning element of this antenna.



7. Packaging

(1) Quantity/Reel: 6000pcs/Reel

(2) Plastic Tape

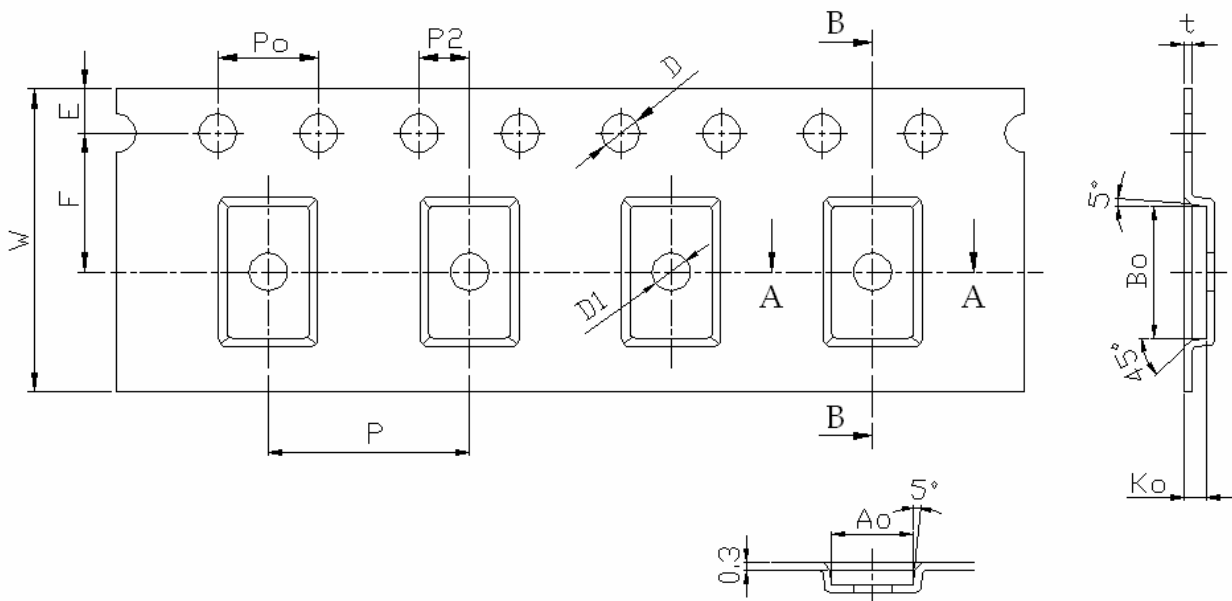

1. Cumulative tolerance of 10 sprocket hole pitch: $\pm 0.20\text{mm}$
2. Carrier camber not to exceed 1mm in 250mm
3. A_0 and B_0 measured on a plane above the inside bottom of the pocket.
4. K_0 measured from a plane on the inside bottom of the pocket to the top surface of the carrier.
5. All dimensions meet EIA-481-B requirements.
6. Material: Clear Non Anti-Static Polystyrene.
 Black Conductive Polystyrene.

7.1. Tape Dimensions (unit: mm)

Feature	Specifications	Tolerances
W	12.00	±0.30
P	8.00	±0.10
E	1.75	±0.10
F	5.50	±0.10
P2	2.00	±0.10
		+0.10
D	1.20	-0.00
Po	4.00	±0.10
10Po	40.00	±0.20
10Po	40.00	±0.20

7.2. Pocket Dimensions (unit: mm)

Feature	Specifications	Tolerances
Ao	3.25	±0.20
Bo	5.25	±0.10
Ko	0.90	±0.10
t	0.30	±0.05

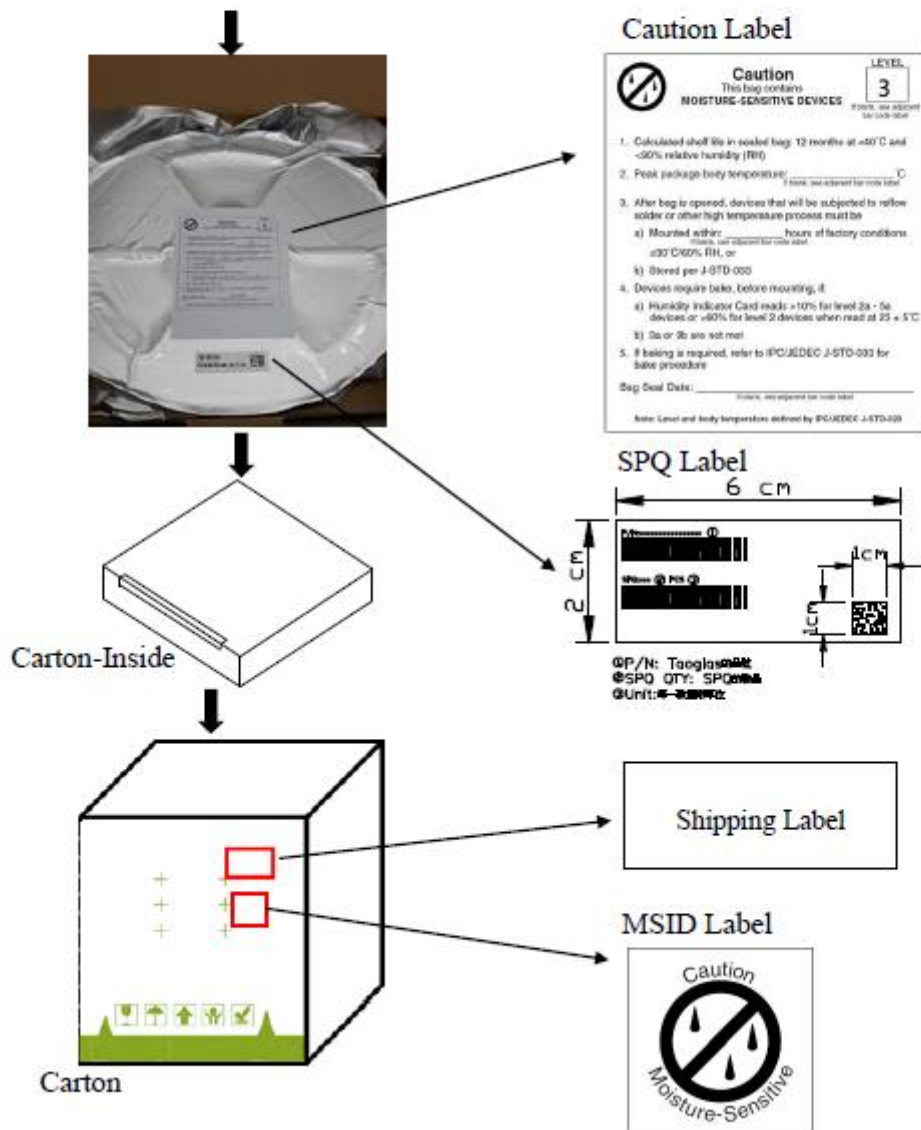
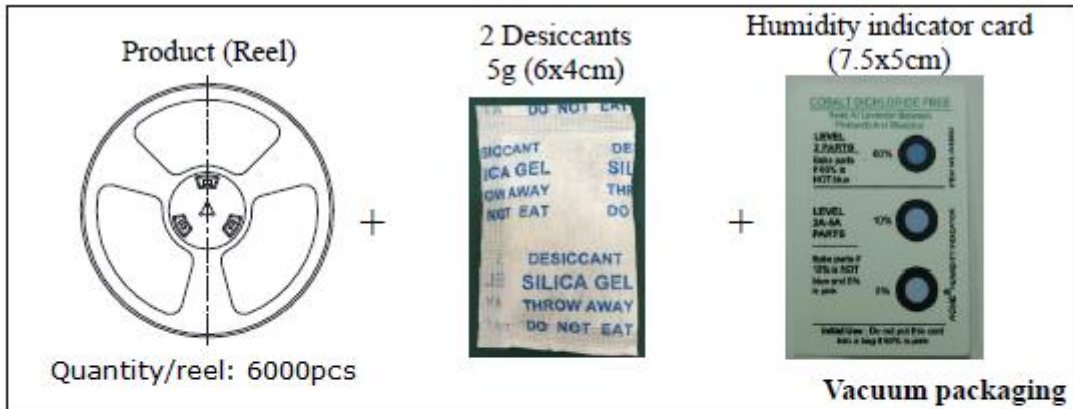



8. Recommended Reflow Profile

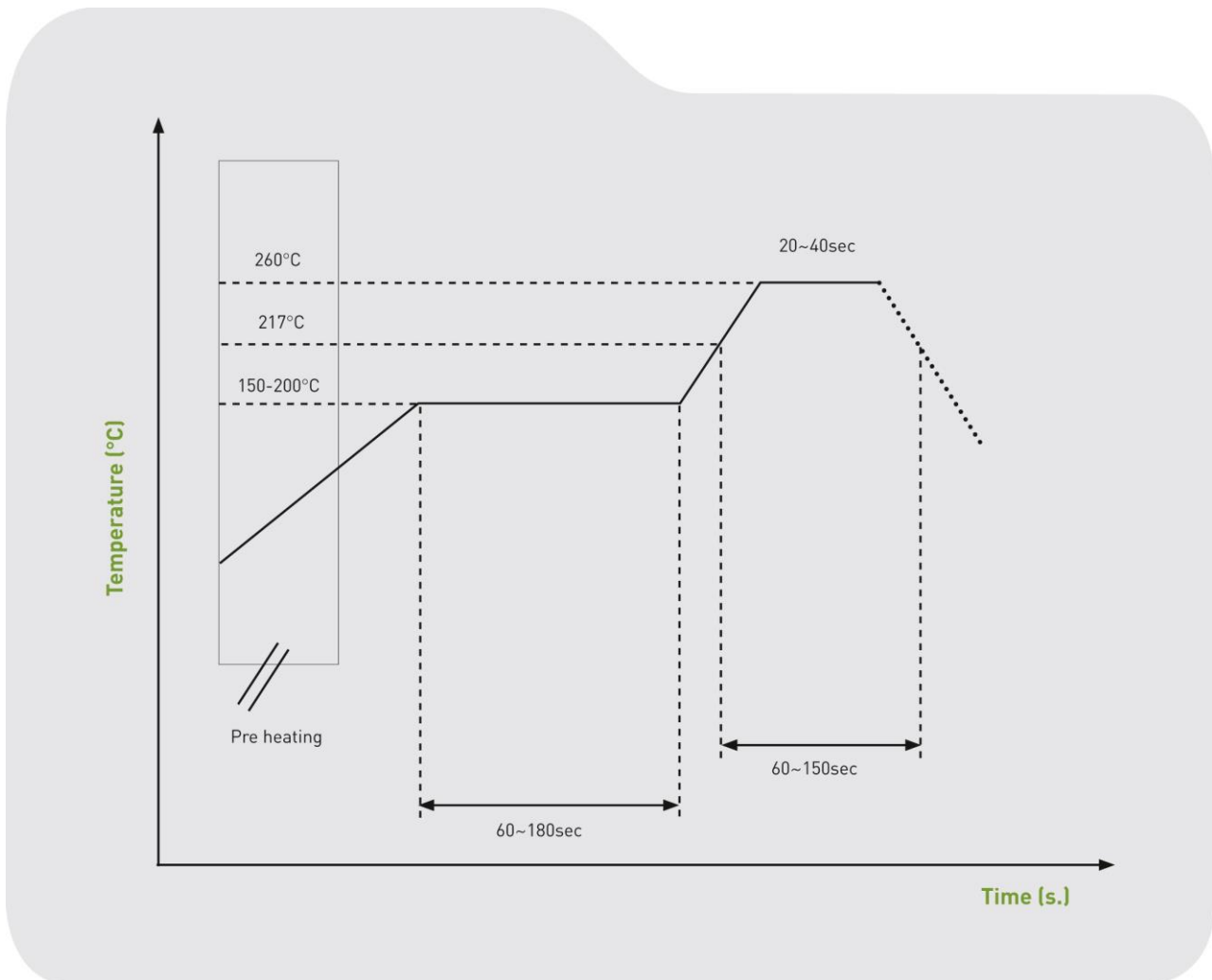

Taoglas makes no warranties based on the accuracy or completeness of the contents of this document and reserves the right to make changes to specifications and product descriptions at any time without notice. Taoglas reserves all rights to this document and the information contained herein.

Reproduction, use or disclosure to third parties without express permission is strictly prohibited.

Copyright © Taoglas Ltd.

X-ON Electronics

Largest Supplier of Electrical and Electronic Components

Click to view similar products for [Antenna Development Tools](#) category:

Click to view products by [Taoglas](#) manufacturer:

Other Similar products are found below :

[0868AT43A0020-EB1SMA](#) [EVALBGSA141MN10TOBO1](#) [A10393-U1](#) [PCSD.06.A](#) [B5771-U1](#) [KIT-LTE-GNSS-01](#) [KIT-WIFI-ISM-01](#)
[A10472-U1](#) [REFLECTOR-EVB-1](#) [A10340-U1](#) [ACAG0201-2450-EVB](#) [ACAG0301-15752450-EVB](#) [ACAG0301-1575-EVB](#) [ACAG0301-24505500-EVB](#) [ACAG0301-5500-EVB](#) [ACAG0801-2450-EVB](#) [ACAG1204-433-EVB](#) [ACAG1204-868-EVB](#) [ACAG1204-915-EVB](#)
[ACAR0301-SW2-EVB](#) [ACAR3005-C2WB-EVB](#) [ACAR3005-S824-EVB](#) [ACAR3705-S698-EVB](#) [ACAR4008-S698-EVB](#) [A10137-D](#)
[A10194-U1](#) [A10204-U1](#) [A5645H-EVB-1](#) [A5645-U1](#) [A5887H-EVB-1](#) [A6111-U1](#) [M20057-EVB-1](#) [SR42W001-U1](#) [SR42W009-U1](#)
[SR4G008-U1](#) [SR4G013-U1](#) [SR4G053-EVB-1](#) [SR4L049-EVB-1](#) [SRC5G027-U1](#) [SRCW004-U1](#) [1001312-01](#) [M310220-01](#) [M620720-01](#)
[M830120-01](#) [M830520-01](#) [EB_NN01-105A](#) [EB_NN02-201-5G](#) [CCKLTE450-NA](#) [AEK-GNCP-TH258L15](#) [MPA-104- KIT](#)