

SPECIFICATION

- Part No. : **GW.17.07.0250E**
- Product Name : 2.4GHz 2dBi Click-in Terminal Dipole Antenna
250mm RG-178 cable IPEX MHFI
- Feature : High radiation performance
Stable efficiency, gain and radiation patterns on
different mounting environments and ground-planes
Hinged 90 degrees
RoHS Compliant



I. Introduction

The GW.17 Click –in Terminal Antenna is a high performance robust 2.4GHz dipole antenna designed for quick assembly onto finished products. The specially designed click in plastic head greatly reduces the assembly time and cost compared with most terminal antennas with connector. The standard product comes with 250mm low loss RG-178 cable and IPEX MHFI (U.FL) connector. Having the cable and IPEX connector coming out directly from the housing eliminates the need for a separate costly cable assembly and bulky mating connector on the device.

The GW.17 has excellent stable radiation properties in all mounting conditions, mounted with and without a ground-plane, in bent 90 degrees or straight position.

Cable length and connector type

II. Specification

ELECTRICAL	
Frequency	2.4 ~ 2.5GHz,
Peak Gain (straight)	2.7dBi
Peak Gain (bend)	1.6dBi
Average Gain (straight)	-1.3dBi
Average Gain (bend)	-1.3dBi
Efficiency (straight)	74%
Efficiency (bend)	74%
Polarization	Linear
Impedance	50 Ohms
Radiation Pattern	Omni
Input Power	2W max.
MECHANICAL	
Antenna Length	112.6mm
Antenna Diameter	9.3mm
Antenna Body Material	TPU
ENVIRONMENTAL	
Temperature Range	-40°C to 85°C
Humidity	Non-condensing 65°C 95% RH

III. Antenna S11 Property

III.1. Return Loss

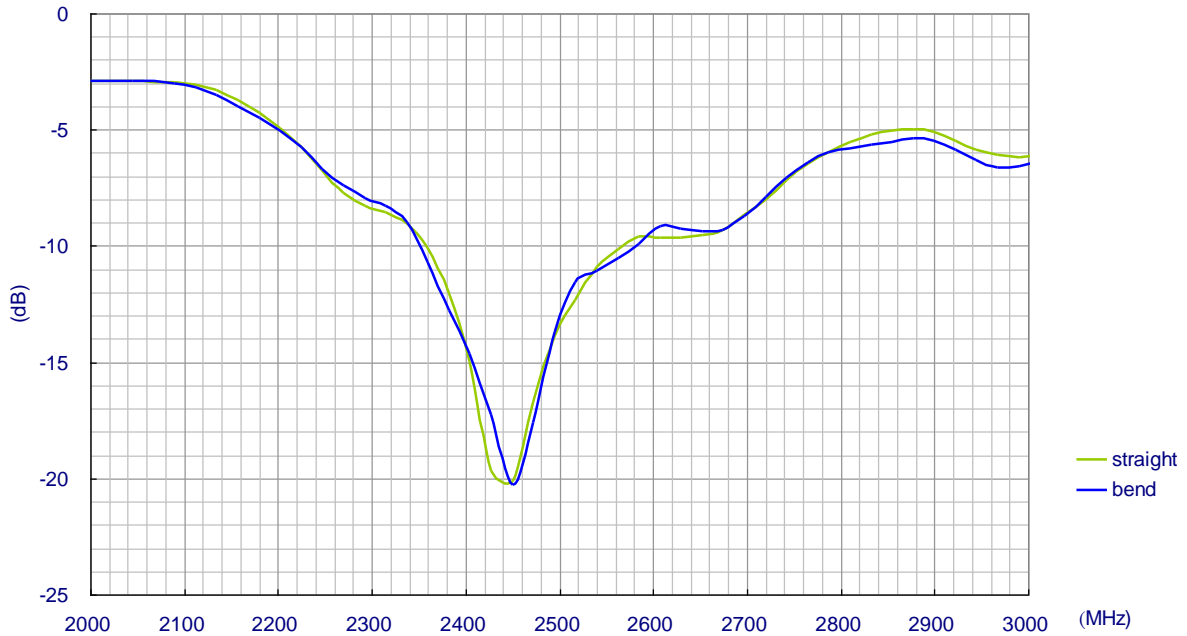

III.2. VSWR

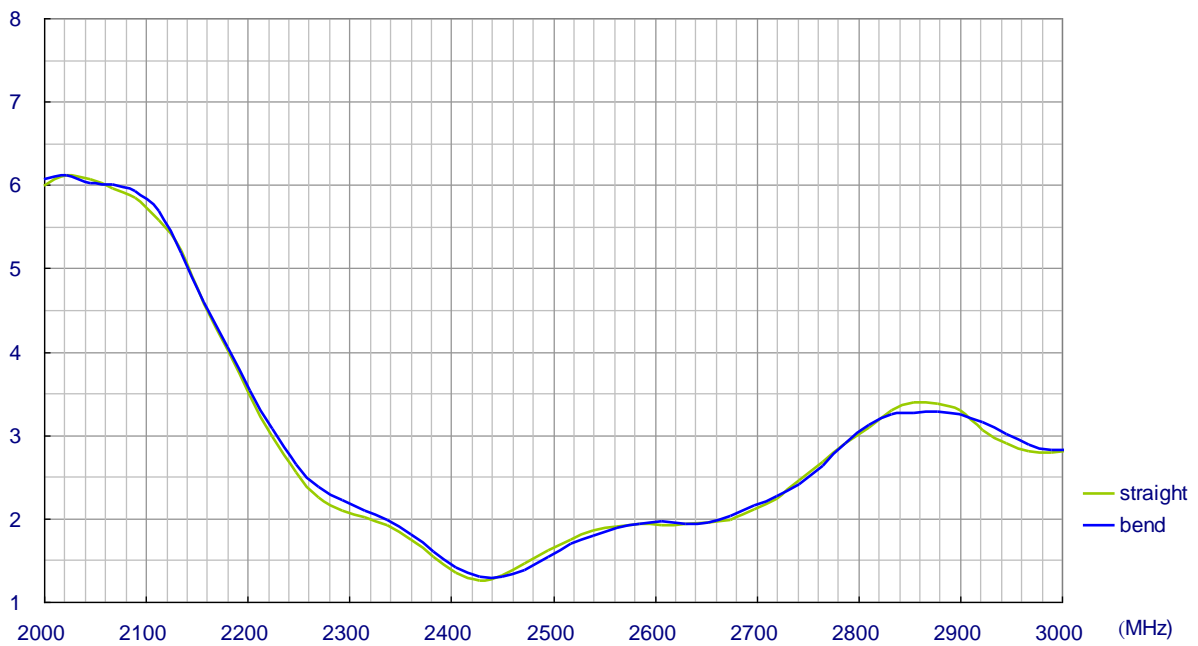

IV. 3D Radiation Property

IV.1. Radiation Efficiency

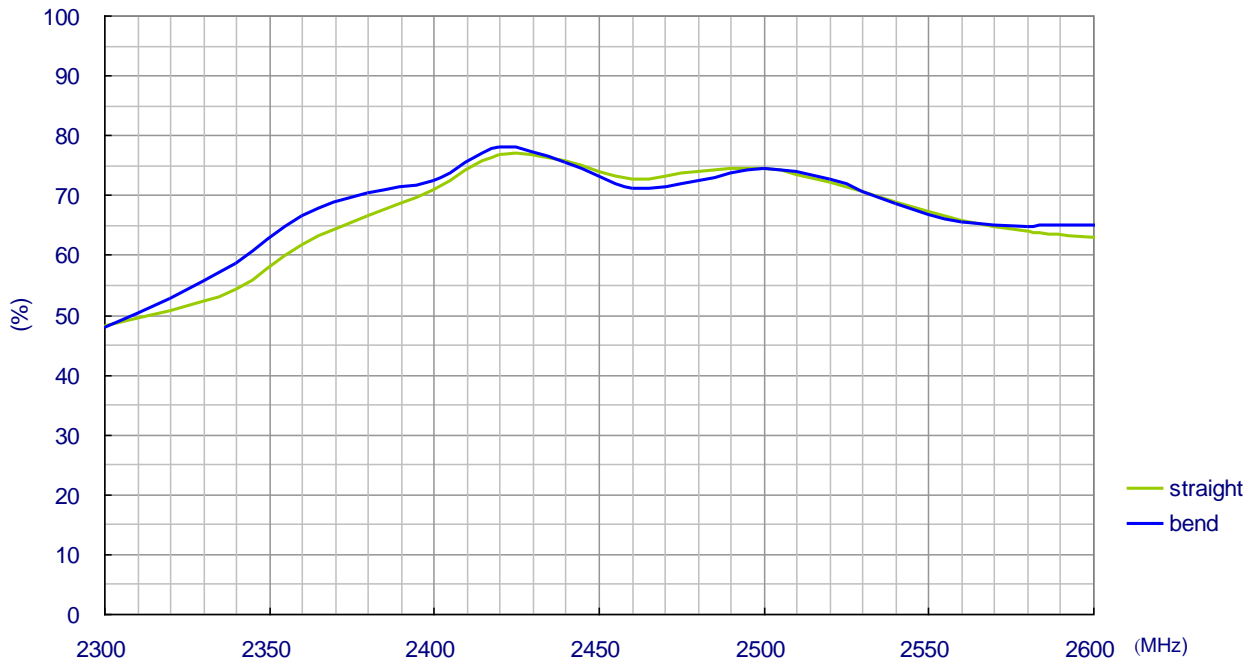

IV.2. Peak Gain

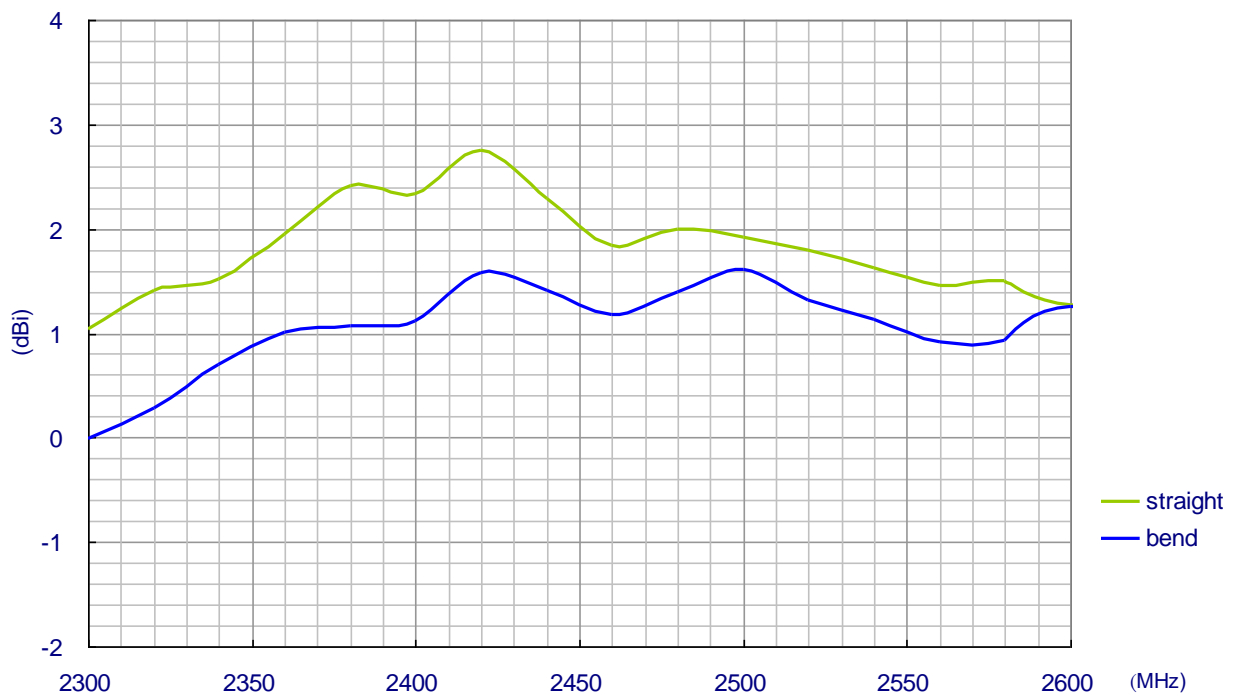

IV.3. Average Gain

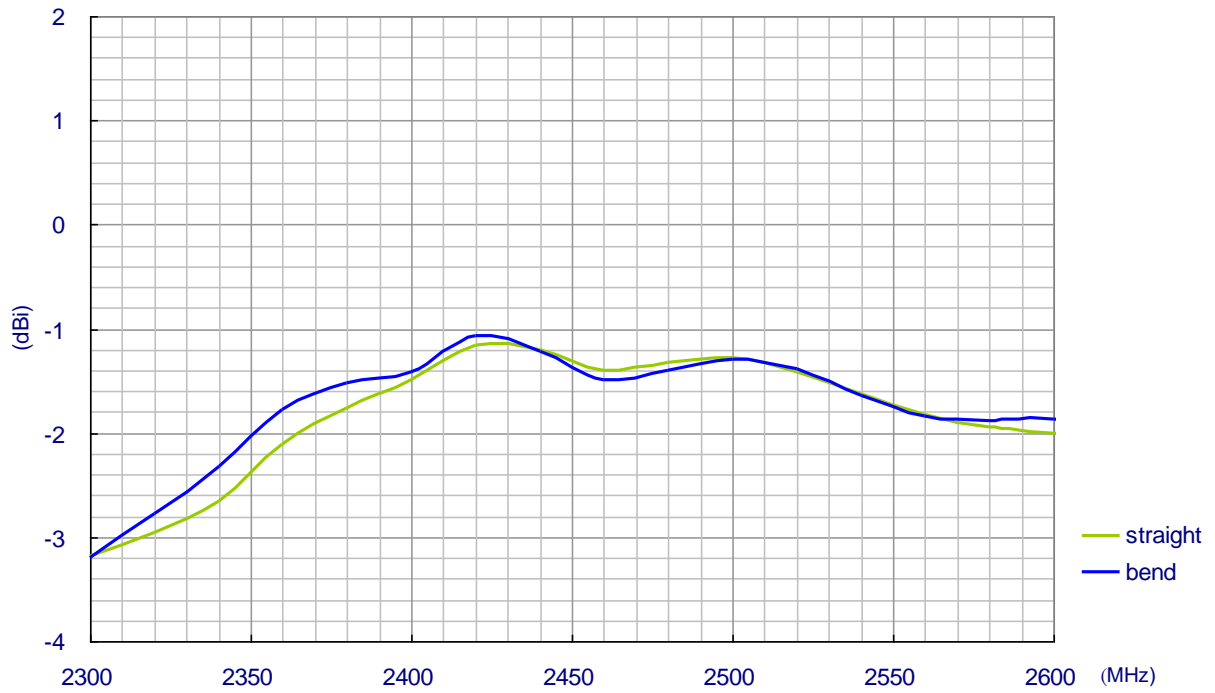

IV.4. Radiation Pattern

E-Plane Radiation of Straight Position

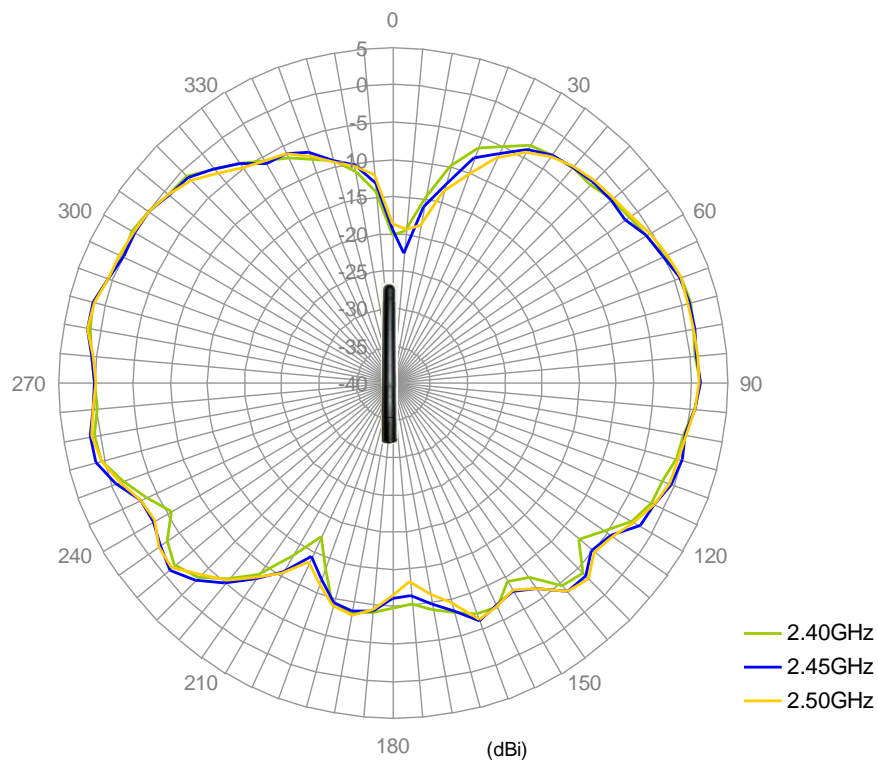

H-Plane Radiation of Straight Position

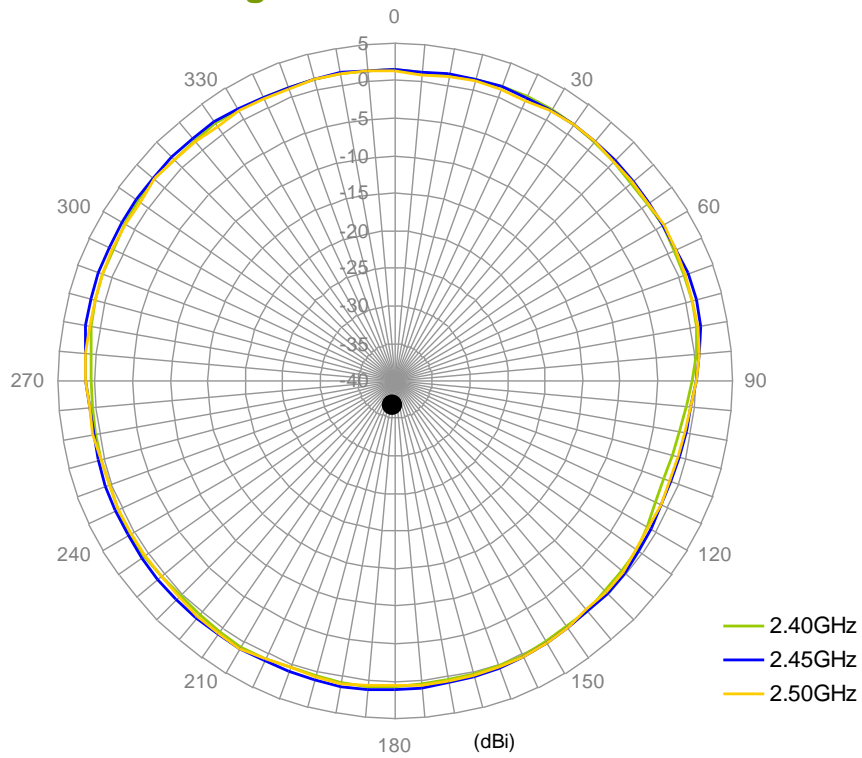

E-Plane Radiation of Bend Position

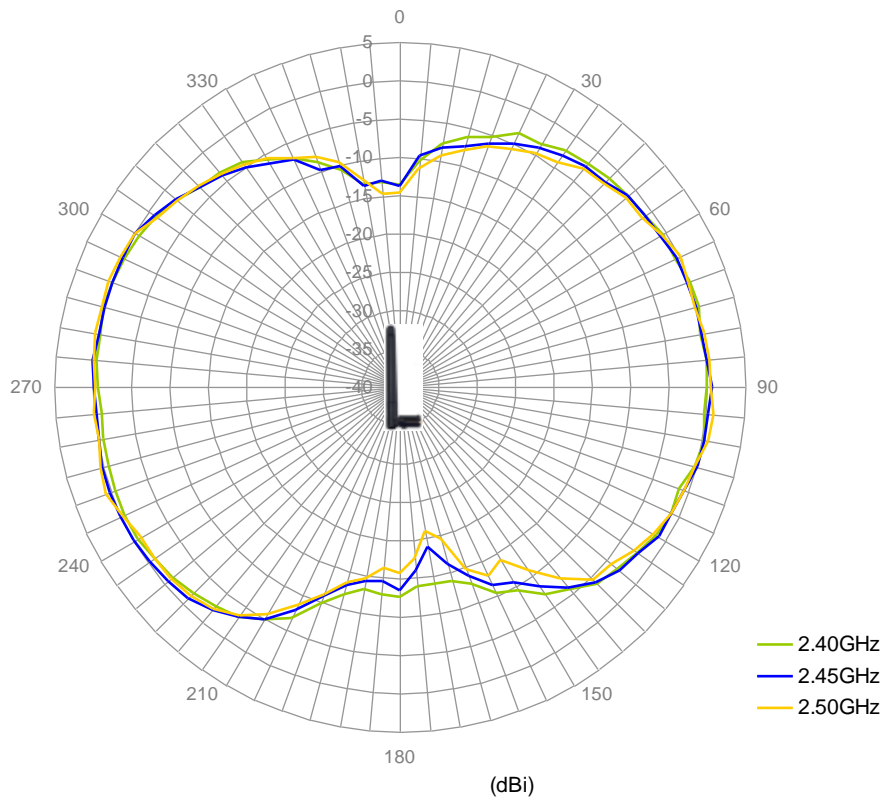

H-Plane Radiation of Bend Position

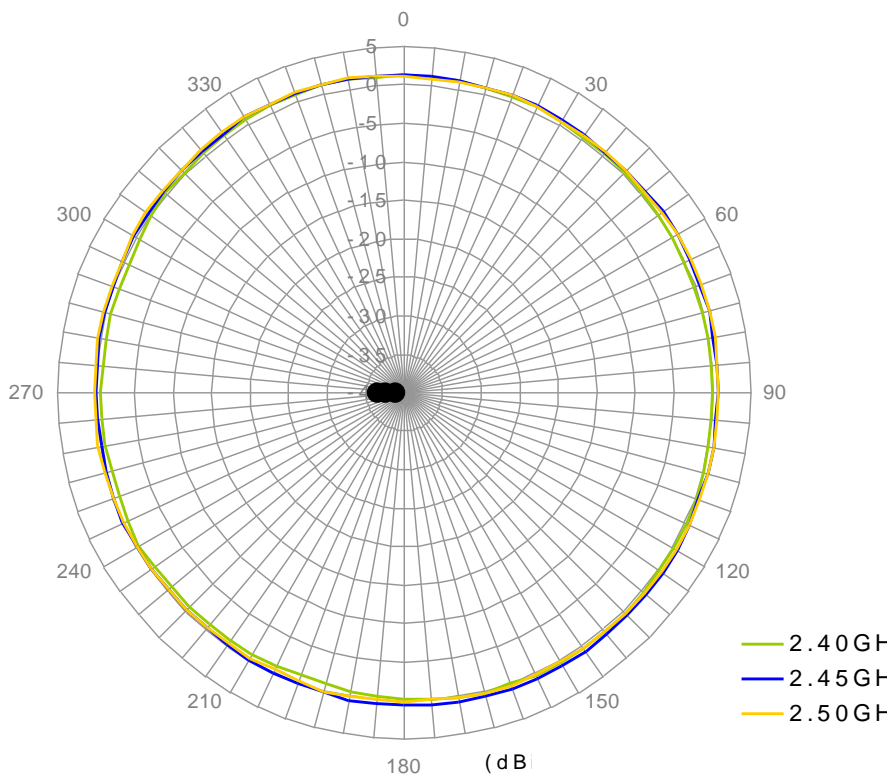

V. Ground Plane Effect

Three ground setups are used to see the affect of positioning GW.17 close to ground -

1. Small Ground (15 x 9cm) – common size of CPE devices. GW.17 is mounted at the longer edge for testing.
2. Big Ground Edge (45 x 30cm) – simulate the effect of mounting antenna on a base station device. GW.17 is mounted at the centre of the longer edge.
3. Big Ground Centre (45 x 30cm) – simulate the effect of mounting antenna in a centre of a big ground plane, such as vehicle top.

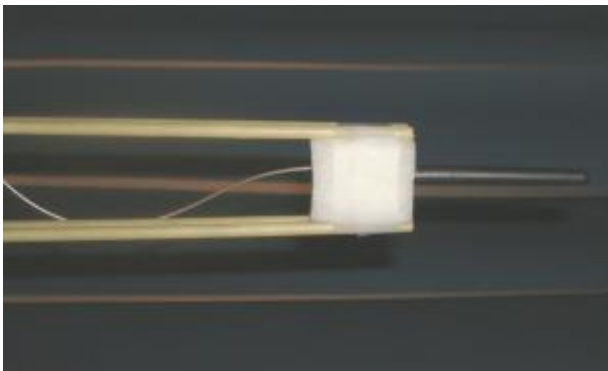

Free space

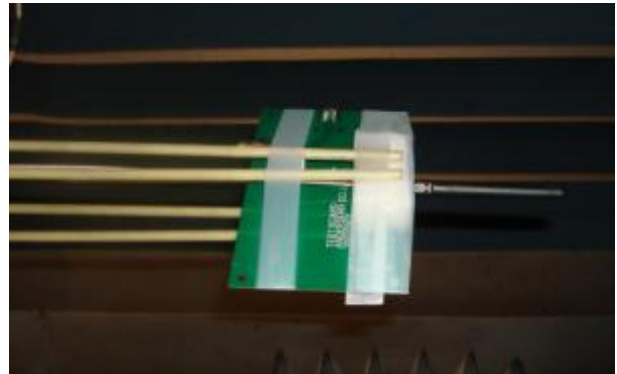

Small ground edge

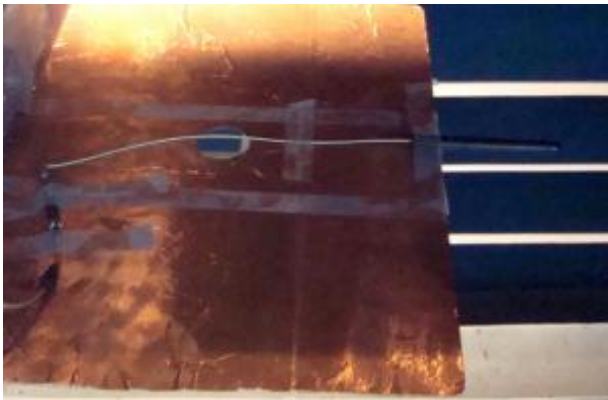

Big ground edge



Big ground center

VI. Radiation Property of GW.17 with Different Ground

VI.1. Radiation Efficiency of Straight GW.17

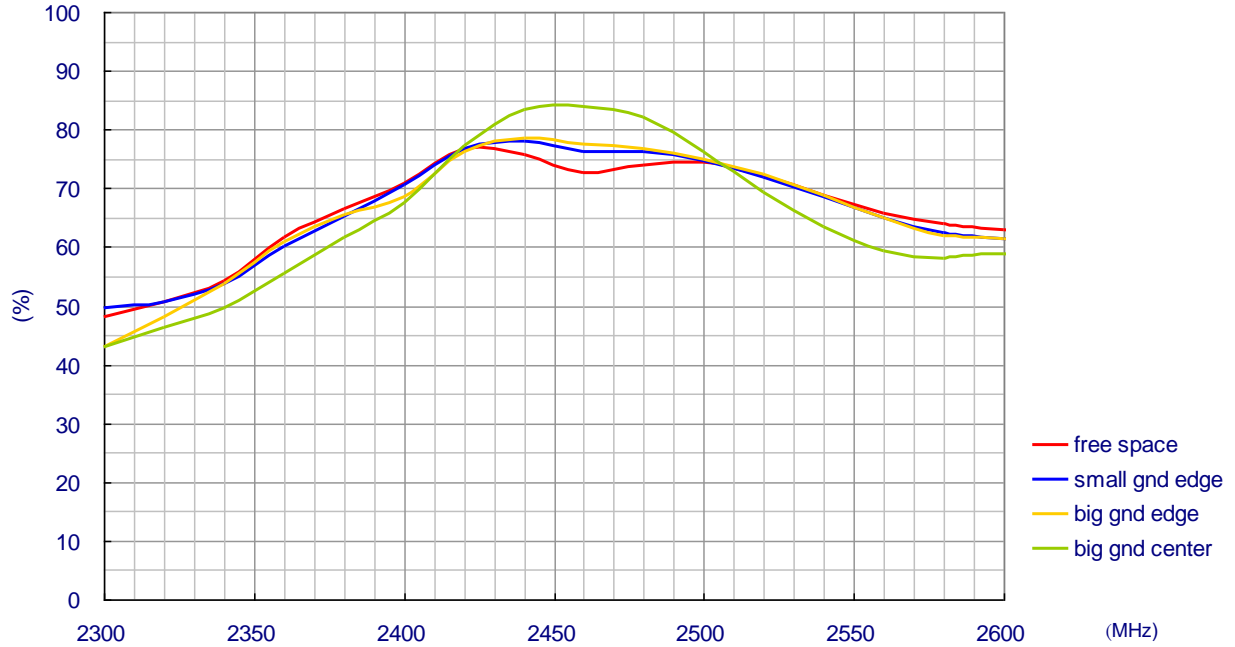

VI.2. Radiation Efficiency of Bend GW.17

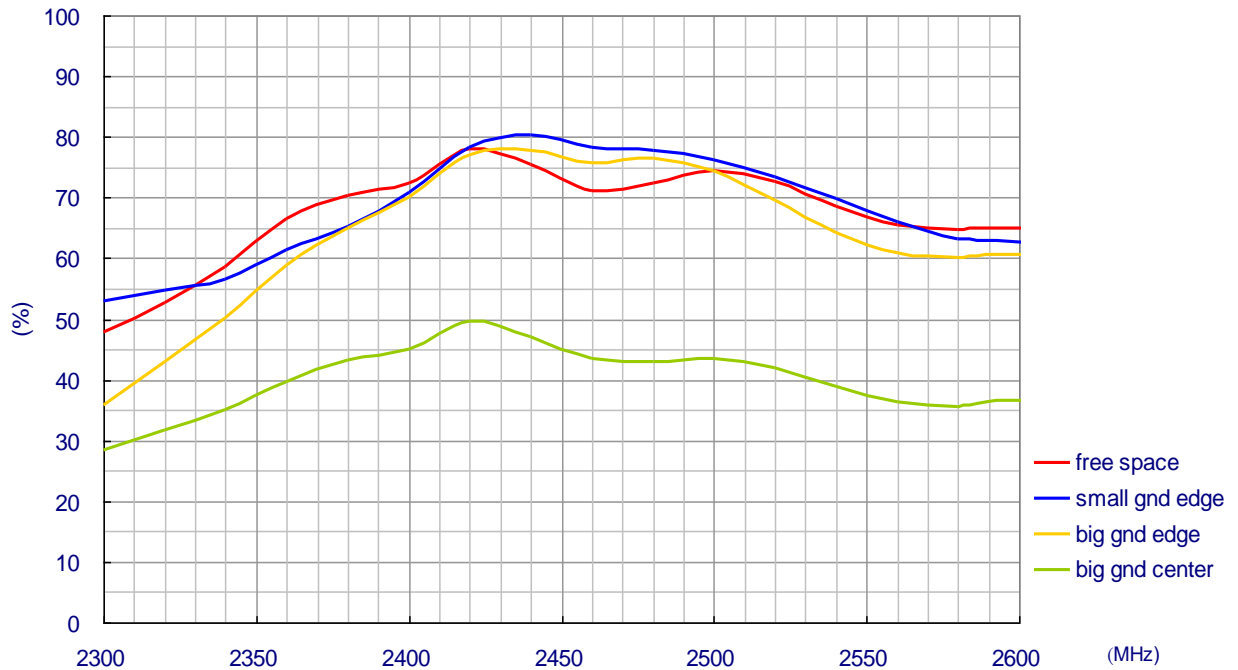

VI.3. Peak Gain of Straight GW.17

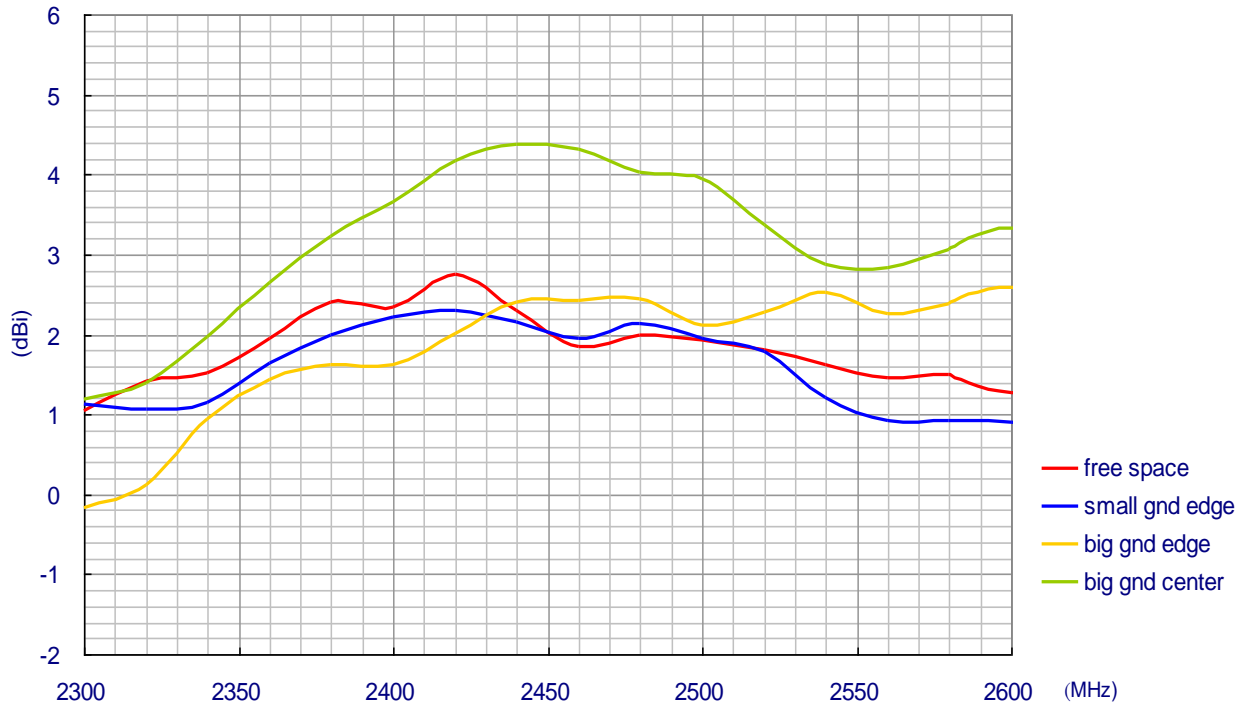

VI.4. Peak Gain of Bend GW.17

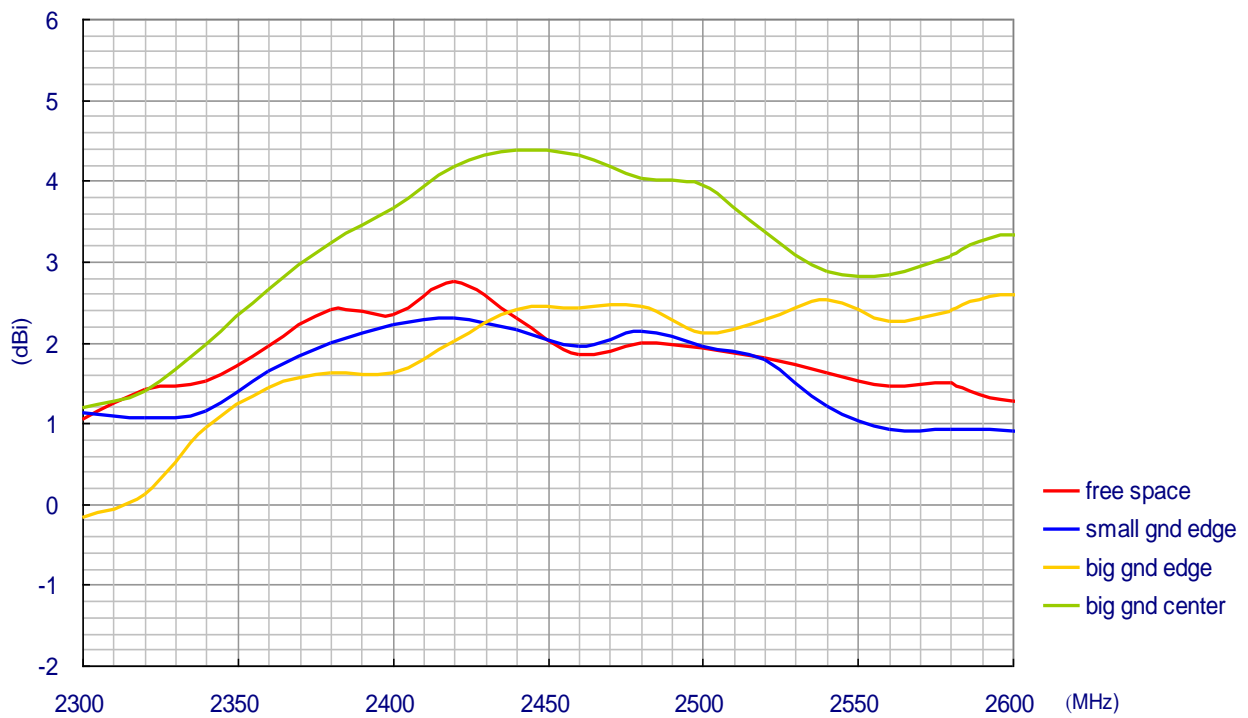

VI.5. Average Gain of Straight GW.17

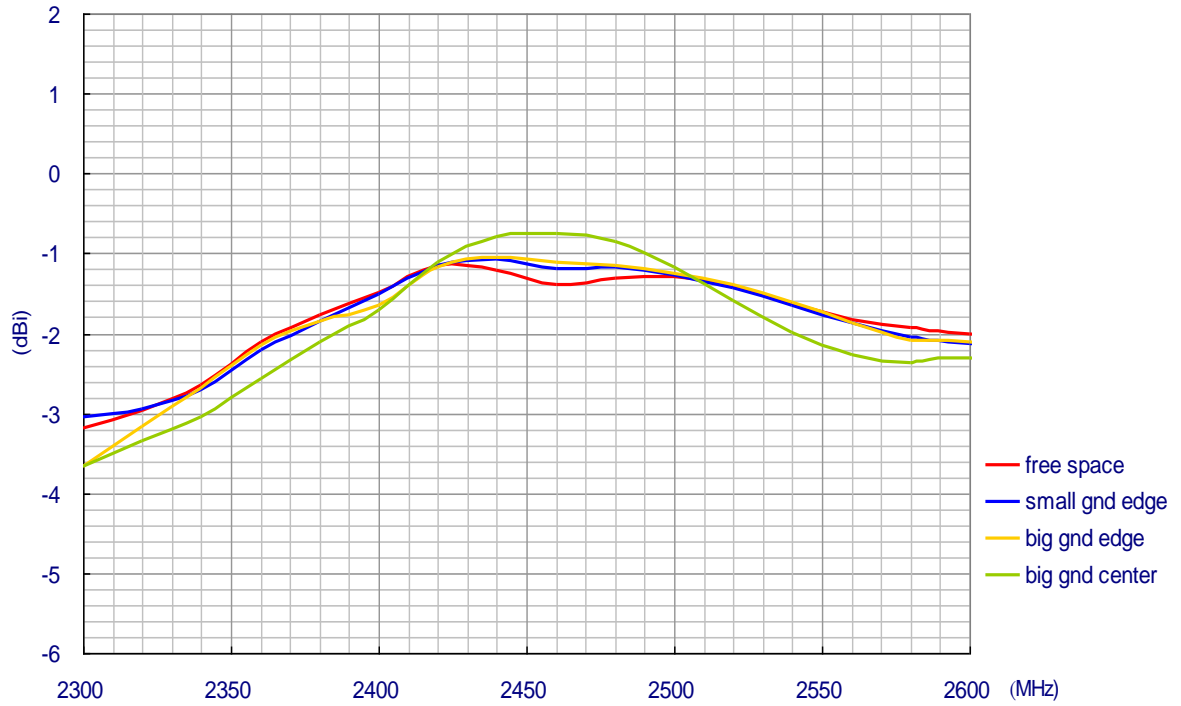

VI.6. Average Gain of Bend GW.17

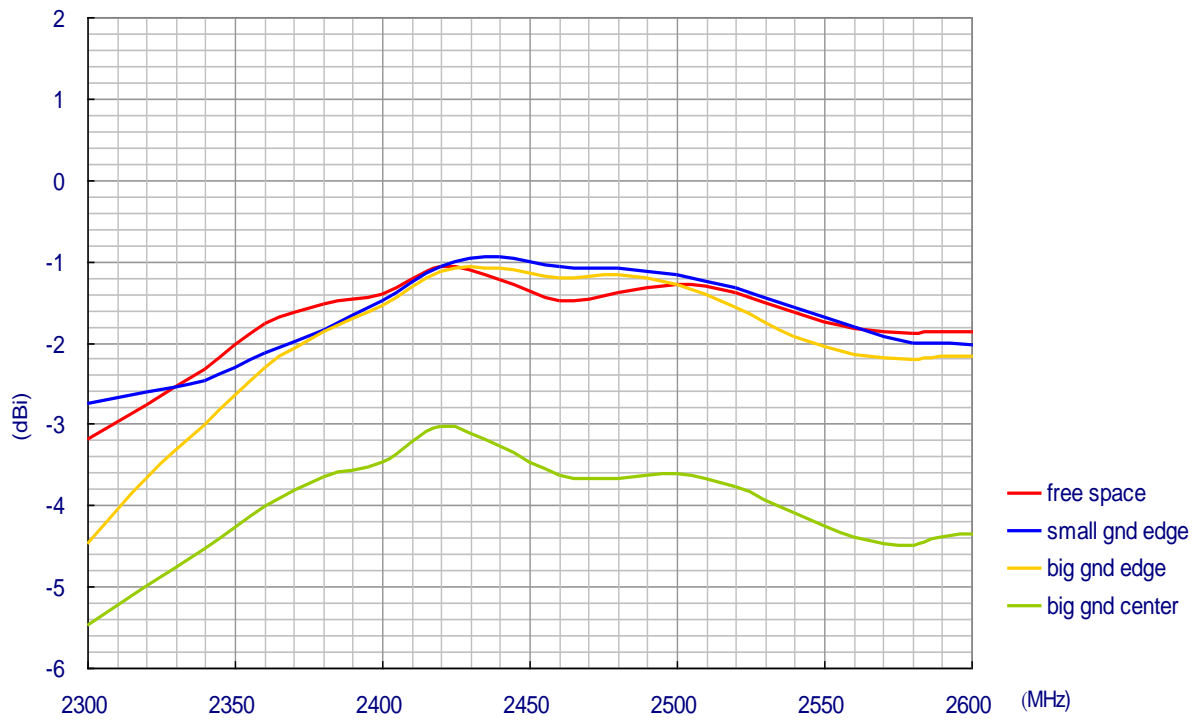

VI.7. Radiation Pattern of Straight GW.17 at 2.40GHz

E-Plane Radiation

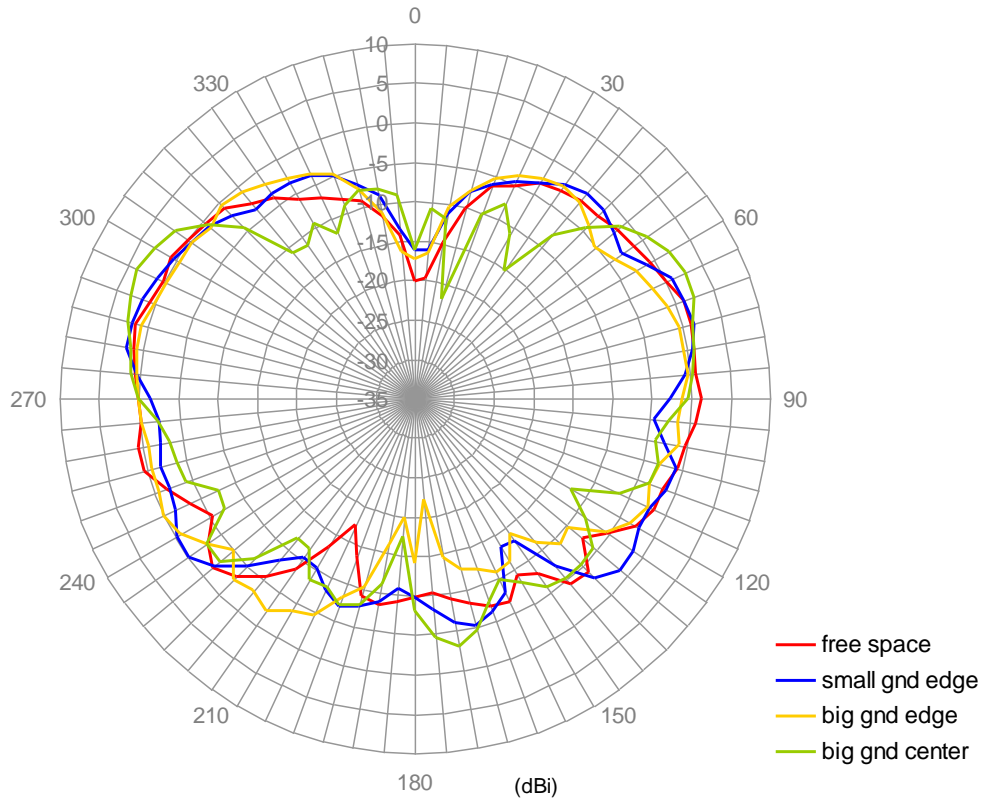

H-Plane Radiation

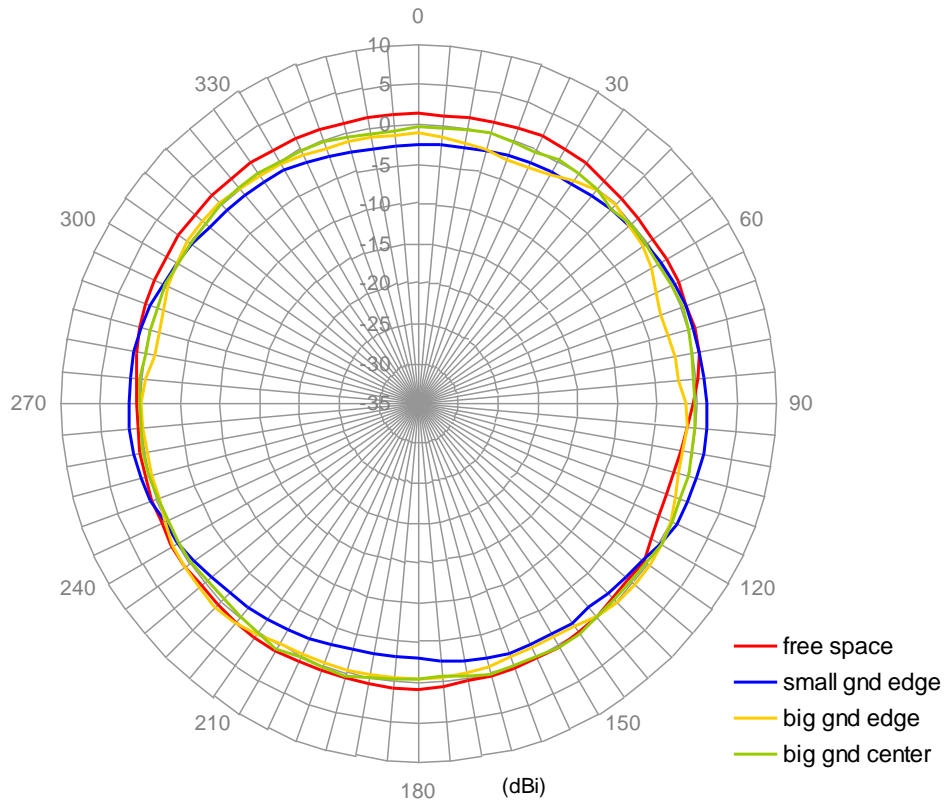

VI.8. Radiation Pattern of Bend GW.17 at 2.40GHz

E-Plane Radiation

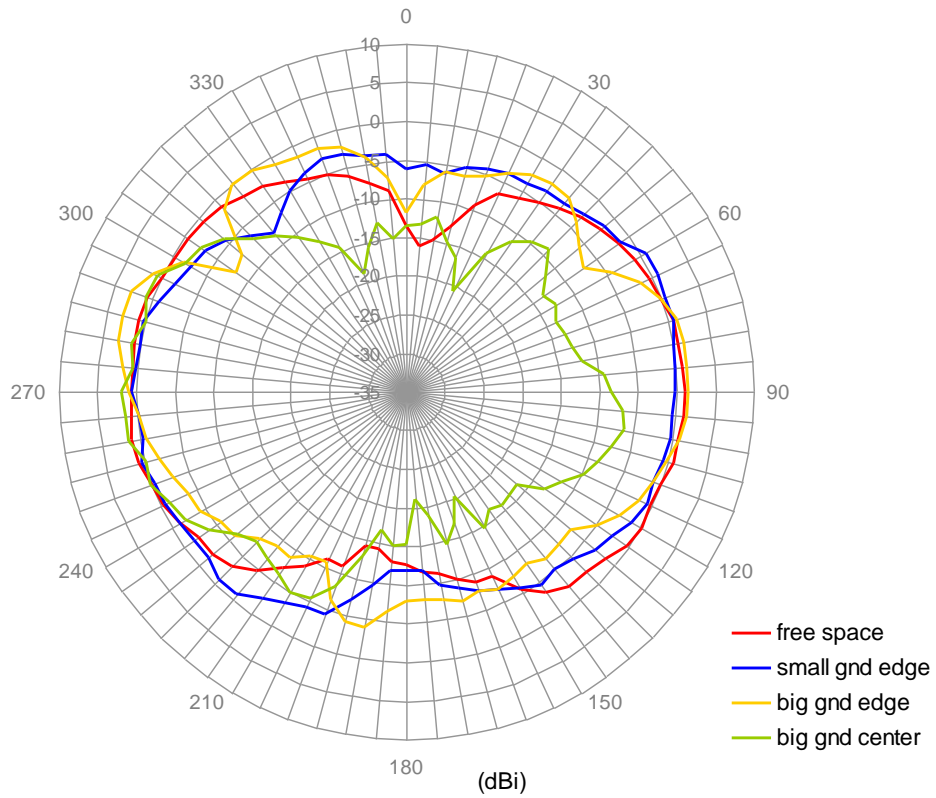

H-Plane Radiation

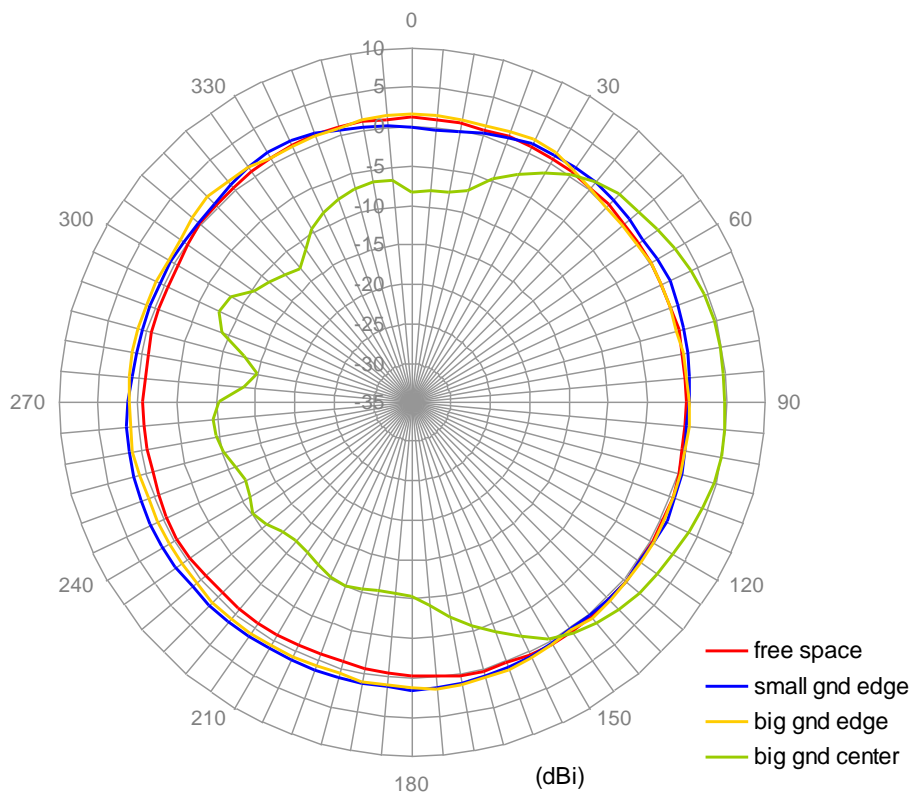

VI.9. Radiation Pattern of Straight GW.17 at 2.45GHz

E-Plane Radiation

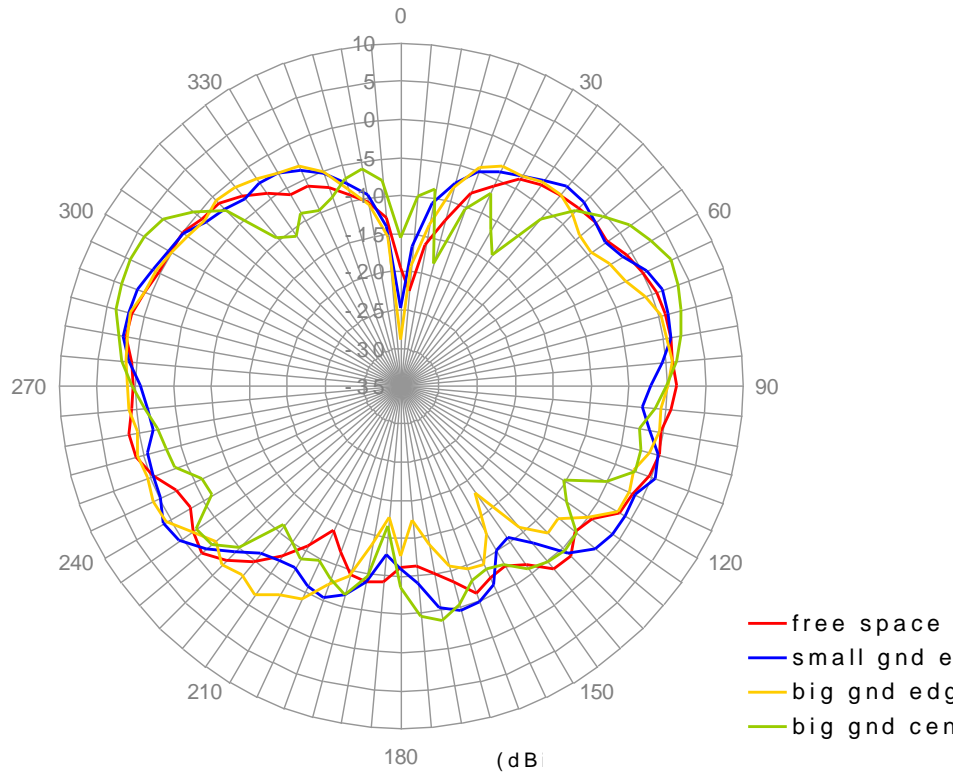

H-Plane Radiation

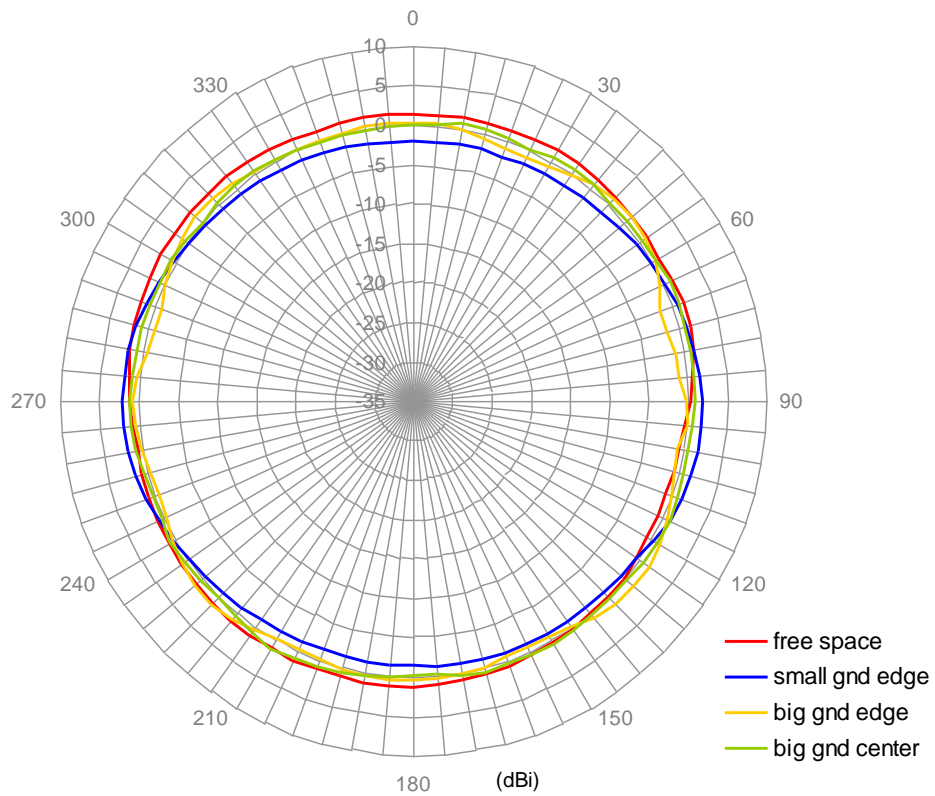

VI.10. Radiation Pattern of Bend GW.17 at 2.45GHz

E-Plane Radiation

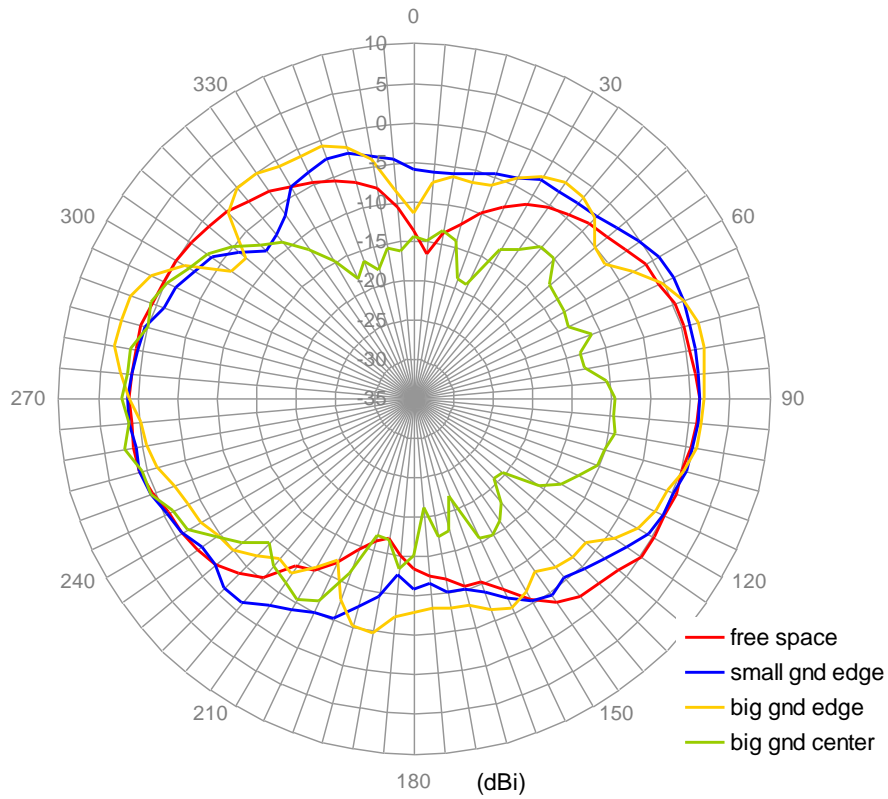

H-Plane Radiation

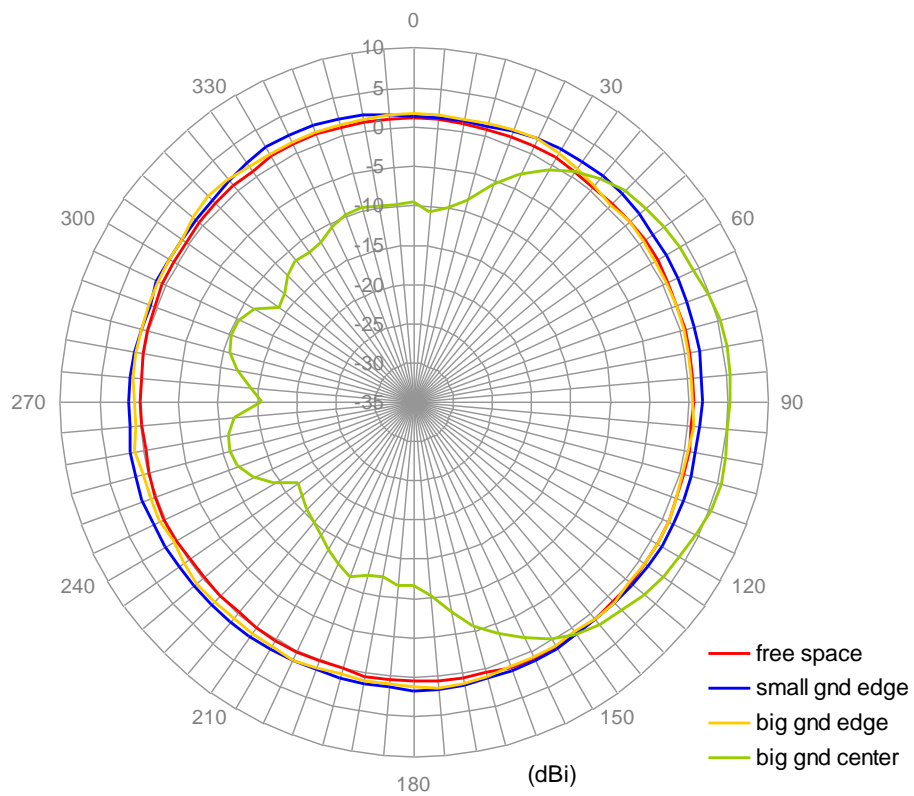

VI.11. Radiation Pattern of Straight GW.17 at 2.50GHz

E-Plane Radiation

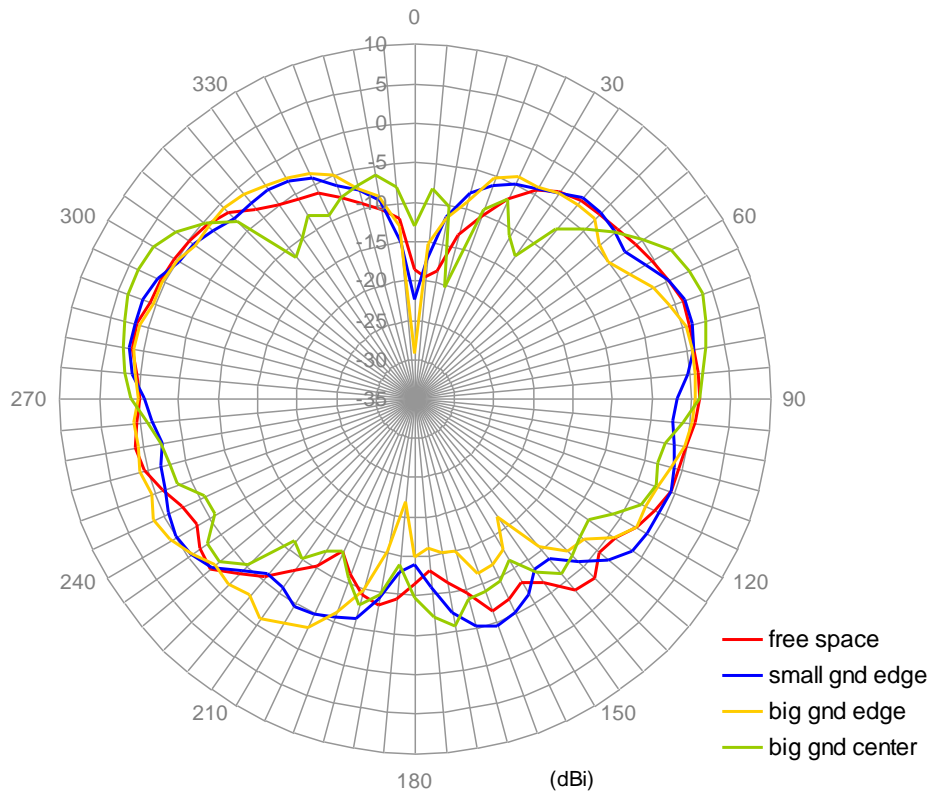

H-Plane Radiation

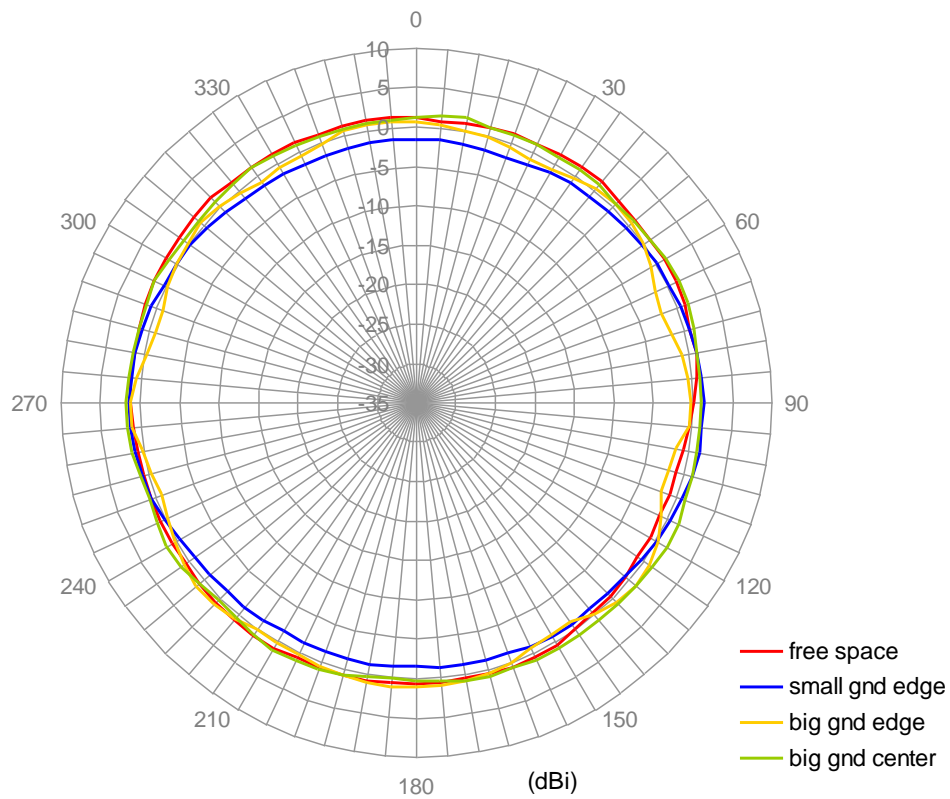

VI.12. Radiation Pattern of Bend GW.17 at 2.50GHz

E-Plane Radiation

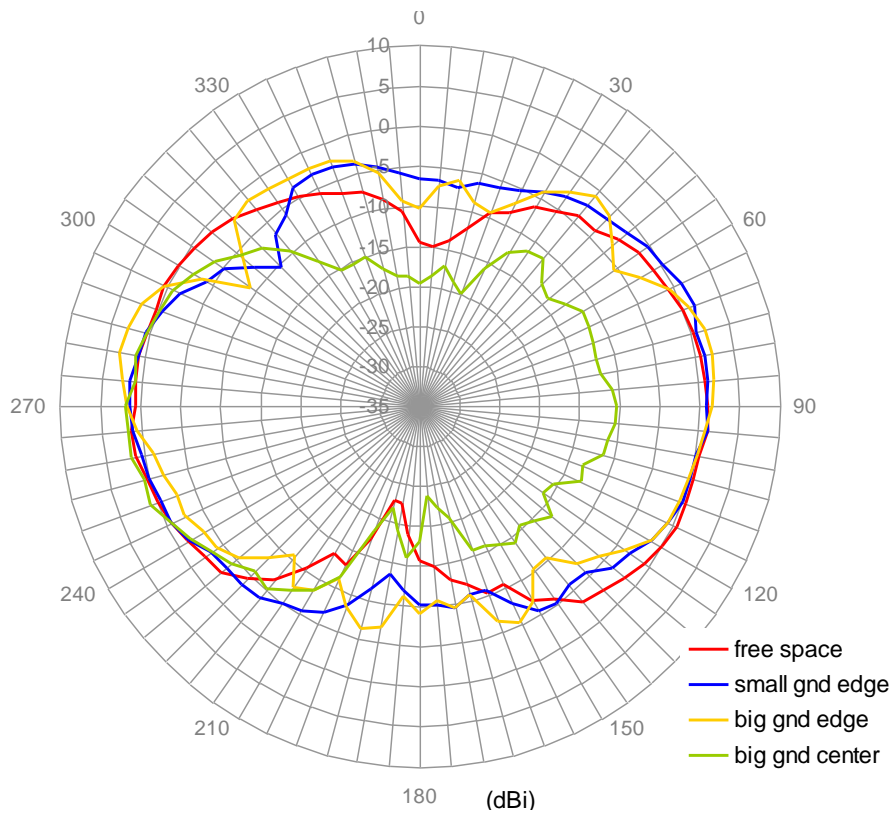

H-Plane Radiation

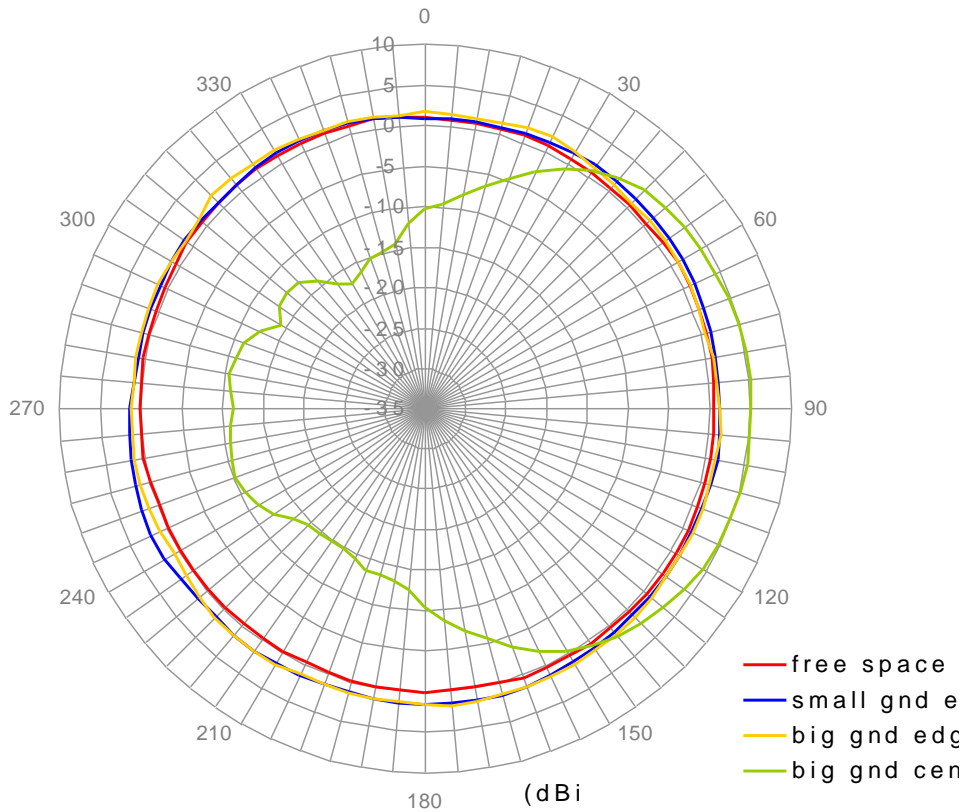

VII. Antenna Drawing

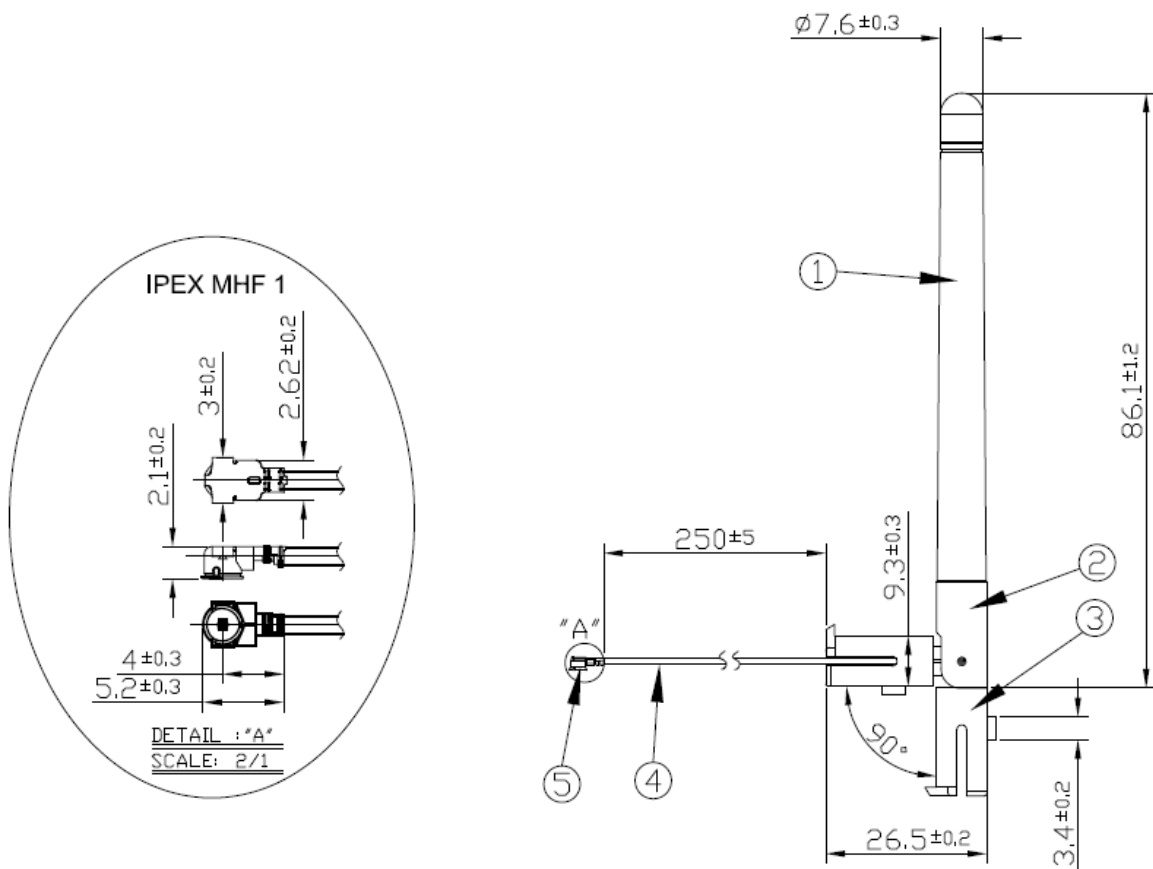

	Name	P/N	Material	Finish	QTY
①	GW.17 Housing	000111J030002A	TPU	Black	1
②	GW.17 Base 1	000111J040002A	Nylon	Black	1
③	GW.17 Base 2	000111J050002A	Nylon	Black	1
④	RG178	301111K000002A	FEP	Brown	1
⑤	IPEX MHF1	IPEX.MHFHT.137	Brass	Gold	1

VIII. Antenna Socket Design

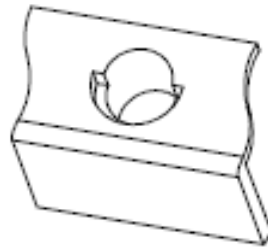

3D View

Top View

Front View

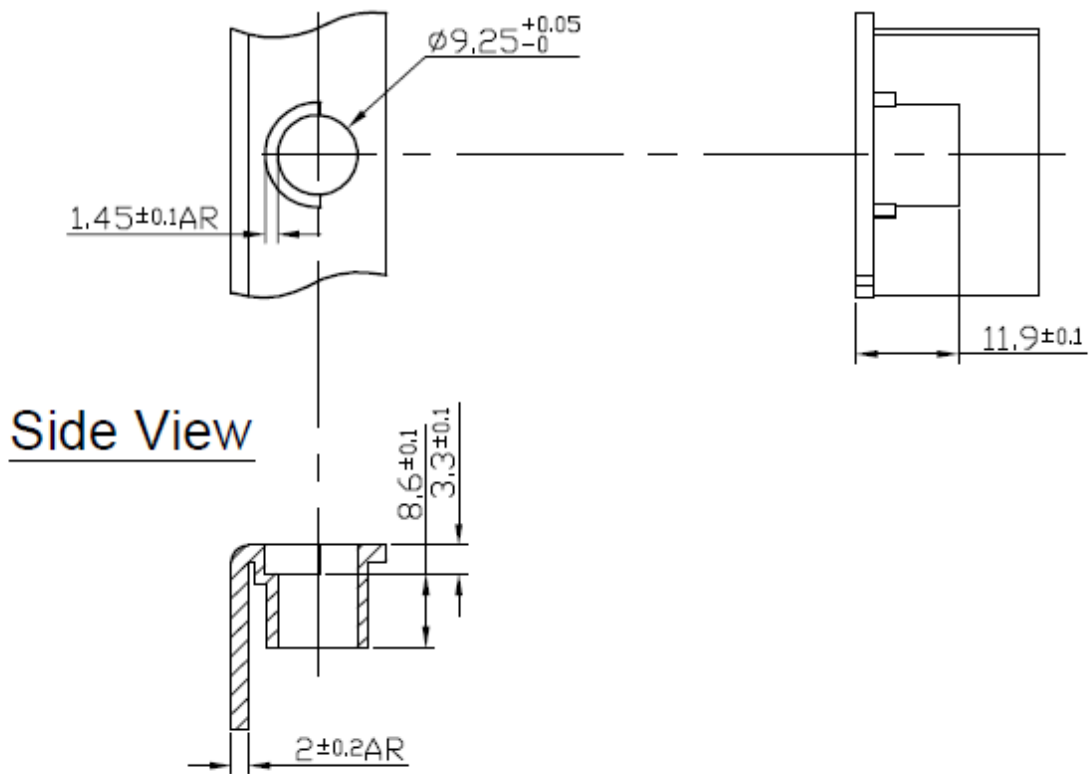

IX. Antenna Insertion Mechanism

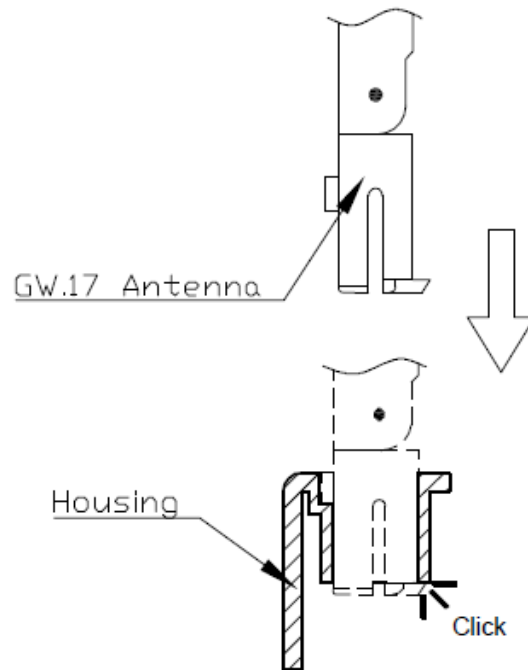

X-ON Electronics

Largest Supplier of Electrical and Electronic Components

Click to view similar products for [Antennas](#) category:

Click to view products by [Taoglas](#) manufacturer:

Other Similar products are found below :

[GAN30084EU](#) [930-033-R](#) [GW17.07.0250E](#) [1513563-1](#) [EXE902SM](#) [APAMPG-117](#) [MAF94383](#) [W3908B0100](#) [W6102B0100](#) [YE572113-30RSMM](#) [108-00014-50](#) [66089-2406](#) [A09-F8NF-M](#) [A09-F5NF-M](#) [RGFRA1903041A1T](#) [W3593B0100](#) [W3921B0100](#) [SIMNA-868](#) [SIMNA-915](#) [SIMNA-433](#) [W1044](#) [W1049B090](#) [A75-001](#) [WTL2449CQ1-FRSMM](#) [CPL9C](#) [EXB148BN](#) [0600-00060](#) [TRA9020S3PBN-001](#) [GD5W-28P-NF](#) [MA9-7N](#) [GD53-25](#) [GD5W-21P-NF](#) [EXB144SM](#) [C37](#) [MAF94051](#) [P1744](#) [MA9-5N](#) [EXD420PL](#) [B1322NR](#) [QWFTB120](#) [MAF94271](#) [MAF94300](#) [GPSMB301](#) [FG4403](#) [AO-AGSM-OM54](#) [5200232](#) [MIKROE-2349](#) [WCM.01.0111](#) [MIKROE-2393](#) [MIKROE-2352](#)