

Specification

Part No	:	GWSFTP.50.3.A.08
Product Name	:	Low Profile GPS & Wi-Fi Terrablast Combination Patch Antenna
Feature	:	GPS with Wi-Fi 2.4GHz Band Single Feed Patch Assembly Ultra-Impact Resistant Right-Hand Circularly Polarized Patent Pending Design Dimensions: 50*50*3mm RoHS Compliant



1. Introduction

The Taoglas GWSFTP.50.3.A.08 is a 50*50mm Terrablast GPS & Wi-Fi embedded stacked passive patch antenna with 3mm thickness. This low profile patch is made from a revolutionary new material developed to meet the unique needs of the UAV and automotive industries. It uses a patent pending antenna technology which results in lighter weight patches, up to 35%, with much greater impact resistance.

Typical applicable industries are:

:: Transportation :: Defense :: Marine
:: Agriculture :: UAV Navigation

The antenna has been tuned and tested on a 70*70mm ground plane and works at GPS (1575.42MHz) and Wi-Fi (2.4Ghz) bands. The GWSFTP.50 is mounted via a pin and double sided adhesive. This antenna works well without modifications in most environment but can be tuned and further optimized to different ground planes and enclosures if this is required. Custom antenna modifications are subject to possible NRE and minimum order quantity.

Terrablast antennas are not suitable for SMD reflow. The correct method is manual soldering at a soldering temperature of 380°C +/- 20°C for a duration of 3 to 5 seconds. All Terrablast antennas undergo rigorous temperature, vibration and impact tests and exceed the highest ISO16750 standards.

For further information, or support to test and integrate Taoglas Terrablast technology please contact your regional Taoglas facility.

2. Specification

Electrical		
	GPS	Wi-Fi
Frequency	1575.42±1.023 MHz	2450±50 MHz
Return Loss	≤-10dB	≤-7dB
Efficiency	40.1 %	24.5 %
Average Gain	-3.9 dB	-6.1dB
Peak Gain	1.6 dBi typ.	0.1 dBi typ.
Polarization	RHCP	RHCP
Impedance	50 Ω	50 Ω
Mechanical		
Dimensions	50 x 50 x 3 mm	
Material	Terrablast	
Pin Diameter	0.9 mm	
Pin Length	2.0 mm	
Weight	15.8g	
Environmental		
Operation Temperature	-30°C to 85°C	
Storage Temperature	-40°C to 95°C	
Humidity	Non-condensing 65°C 95% RH	

* Antenna properties were measured with the antenna mounted on 70*70mm Ground Plane.



3. Antenna Characteristics

3.1 Return Loss

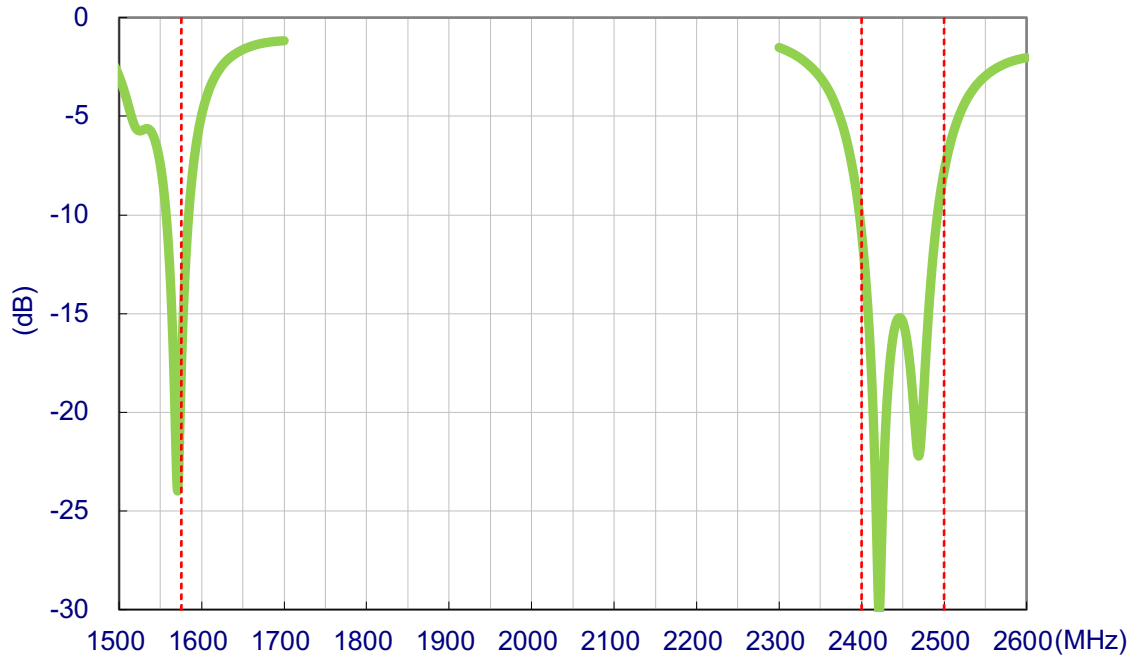

3.2 Efficiency

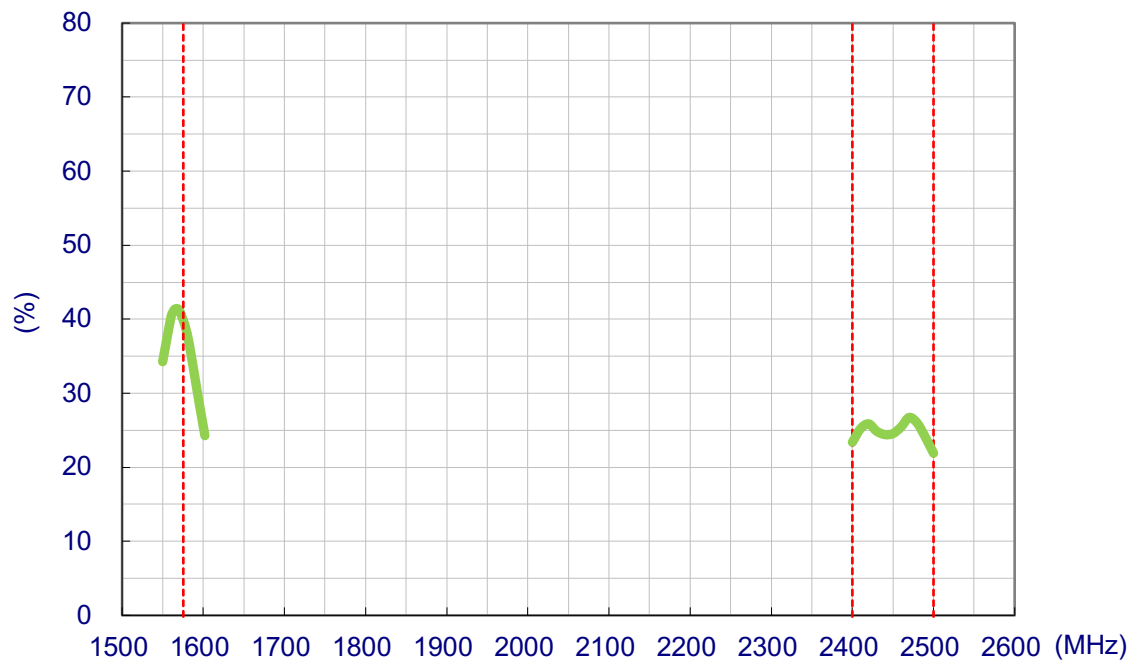

3.4 Peak Gain

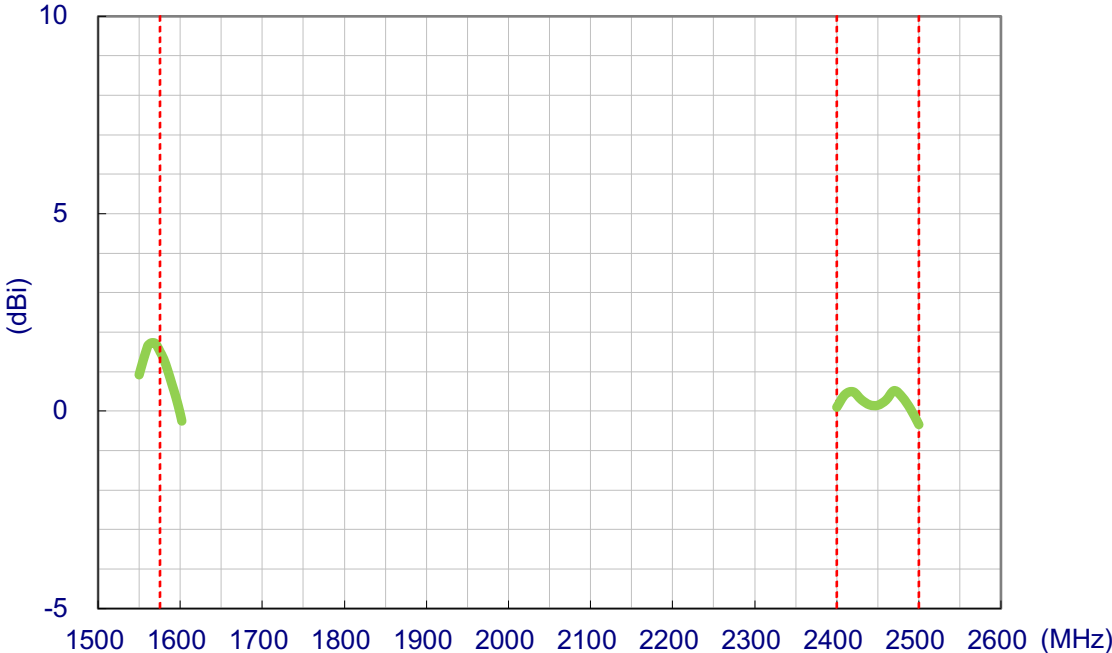

3.5 Average Gain

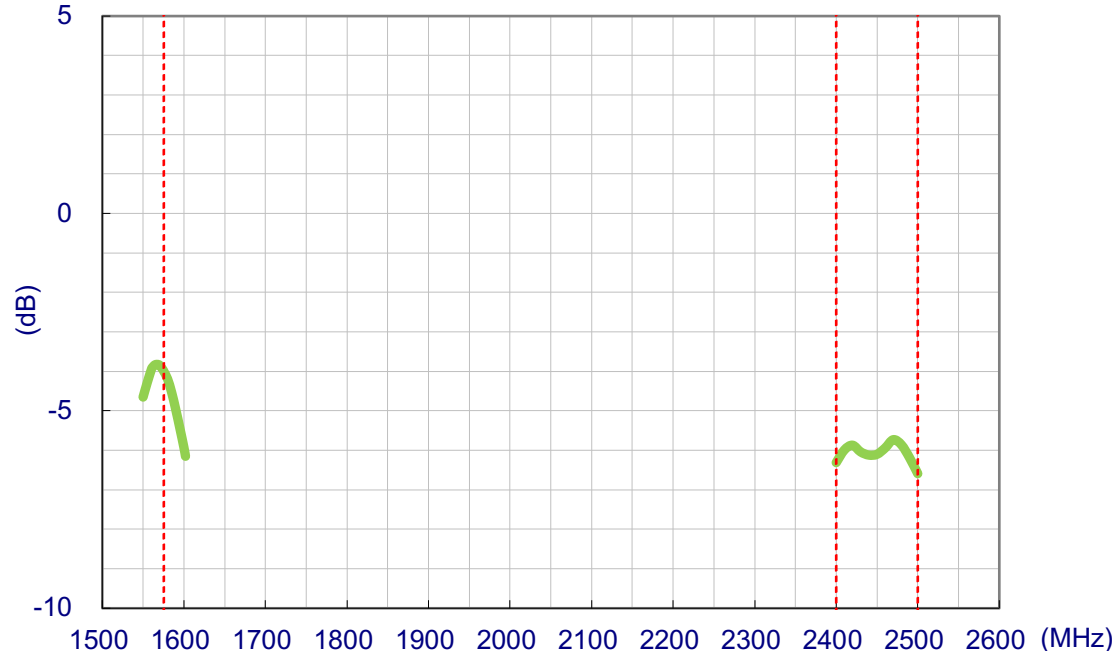

3.6 Axial Ratio

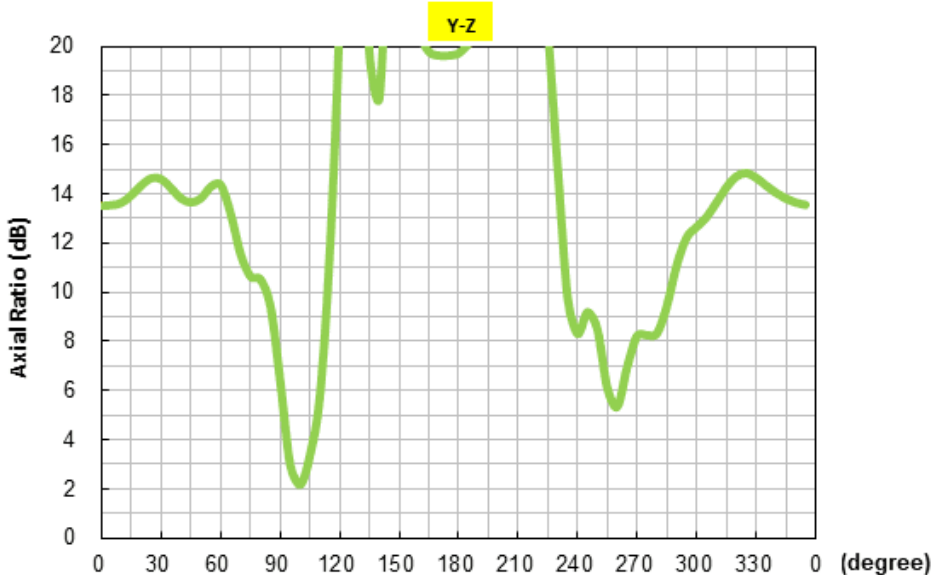
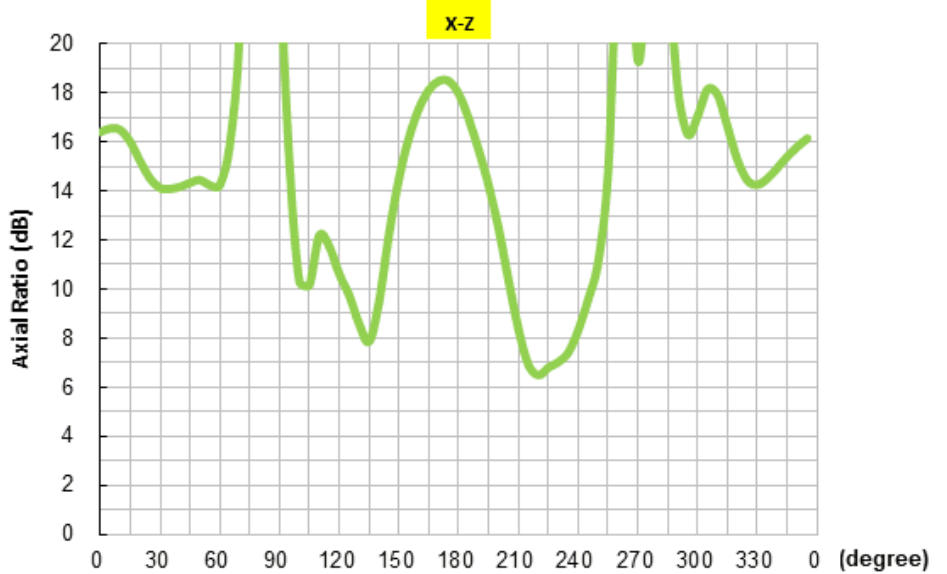

4 2D Antenna Radiation

4.5 Test Setup

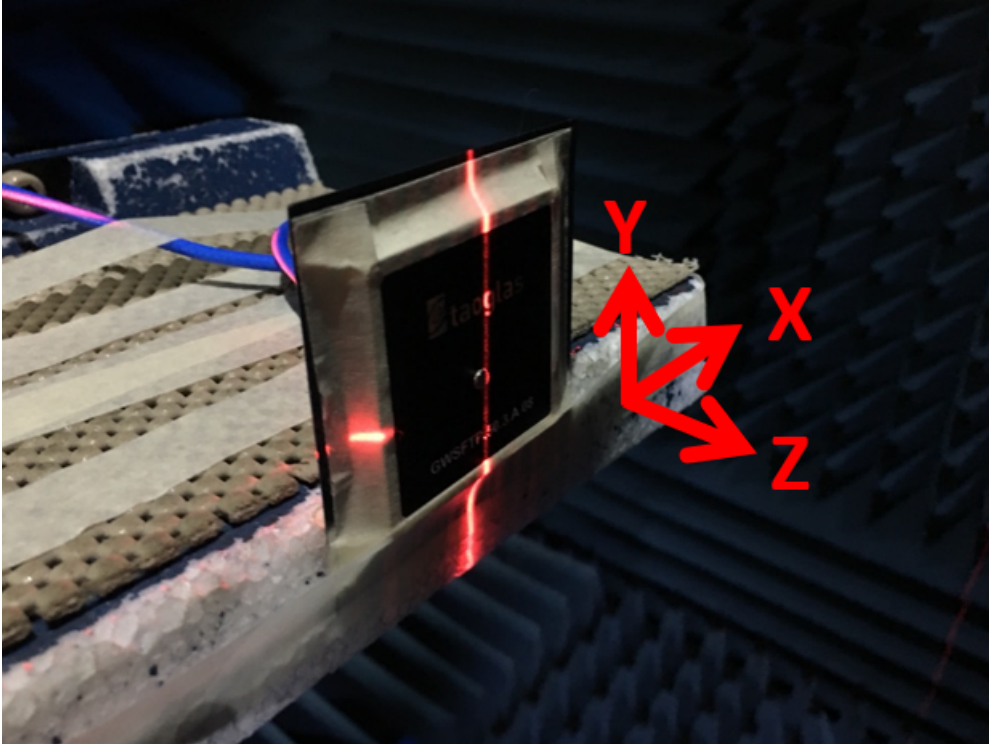

4.6 X-Y Plane

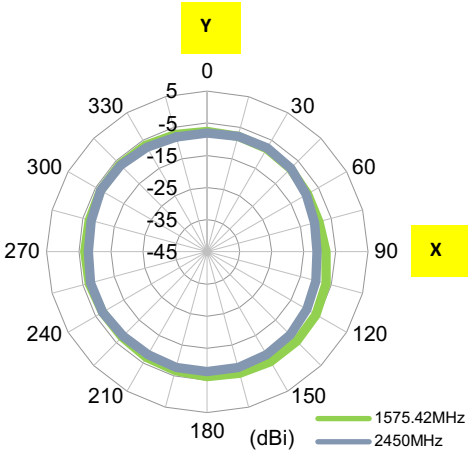

X-Z Plane

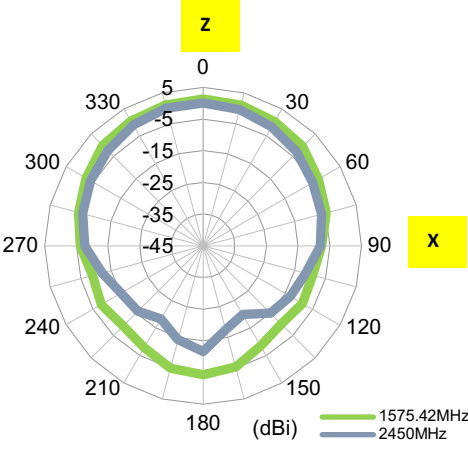

Y-Z Plane

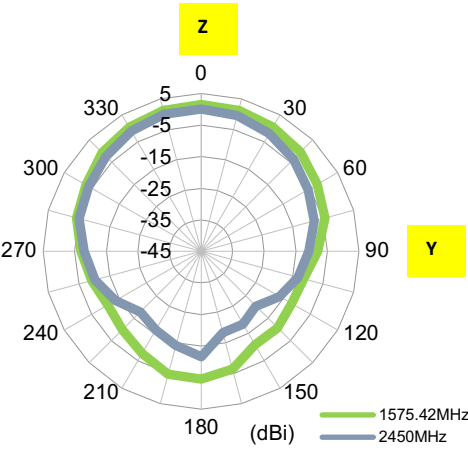

5 3D radiation pattern

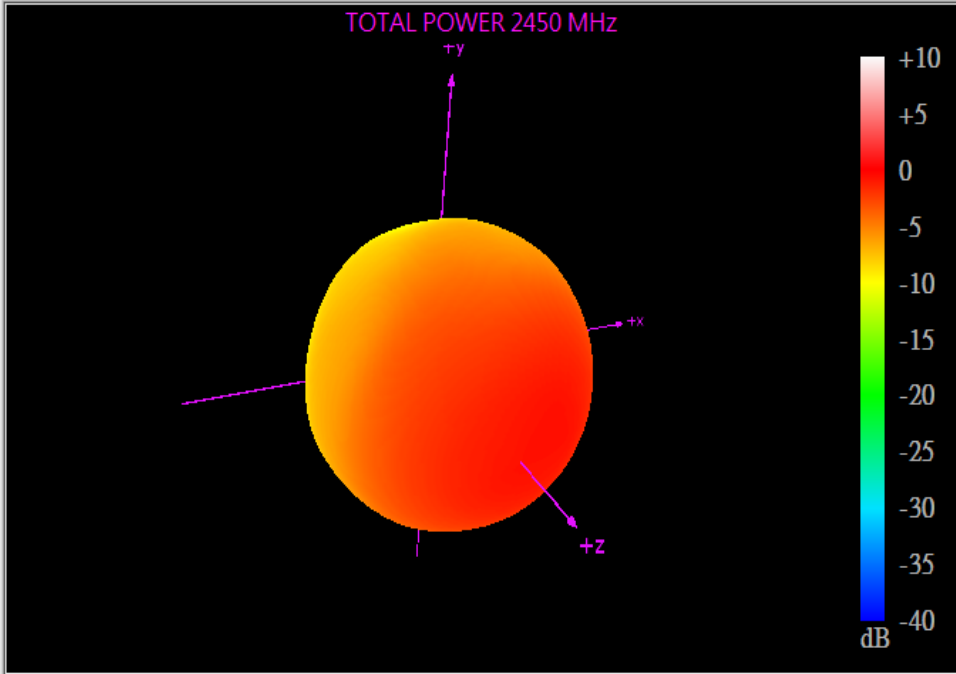
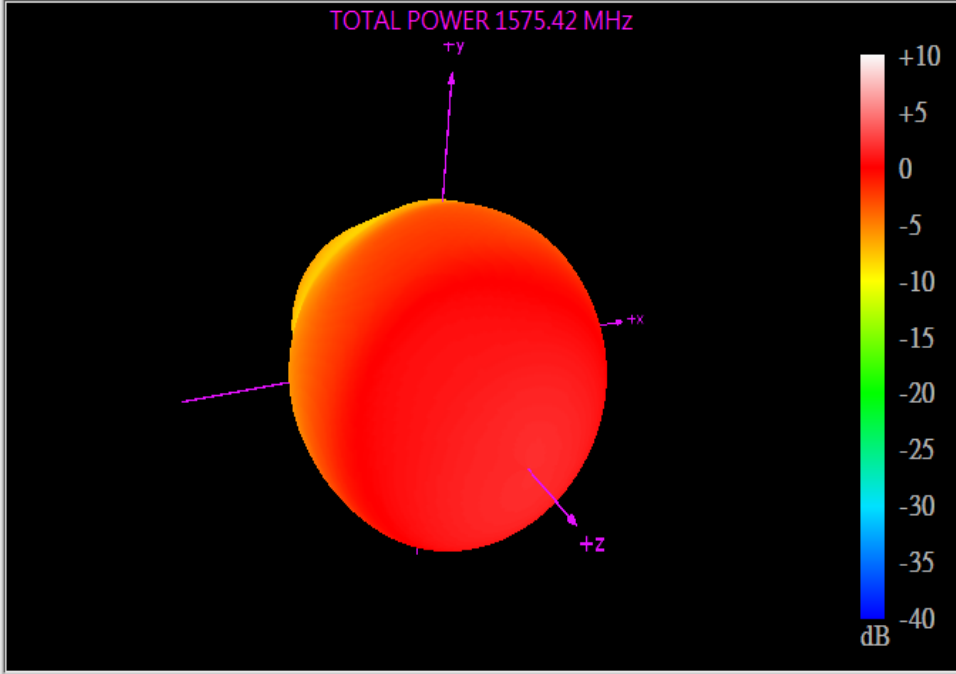

6 Mechanical Drawing-Patch

Front View

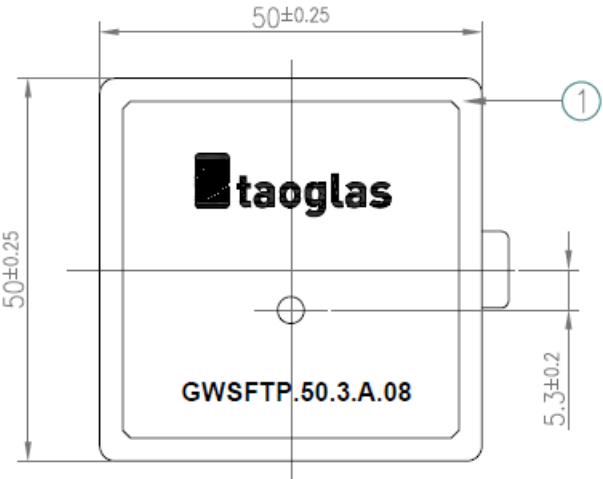

Side View

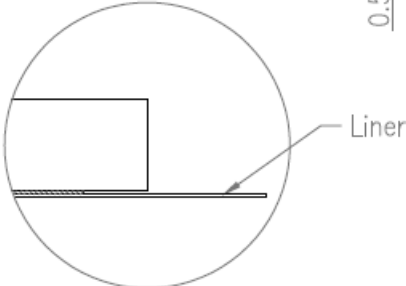
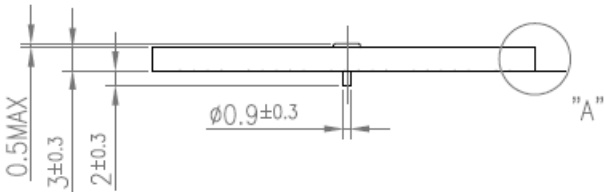

Detail:A
Scale:4:1

Back View

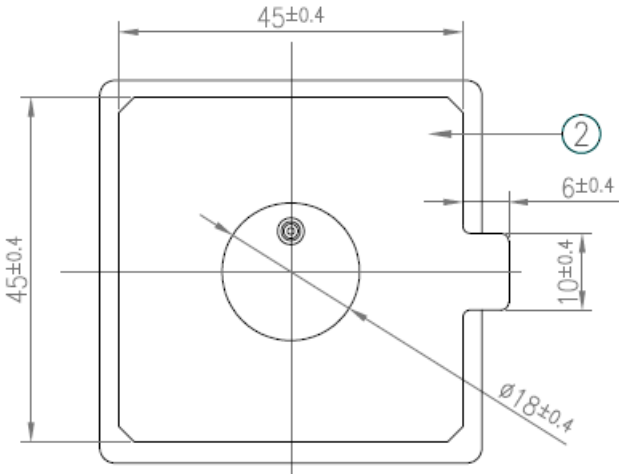

NOTES:
1. Double Sided Adhesive Area. 

	Name	P/N	Material	Finish	QTY
1	Patch	001518H130000A	Terrablast	Clear	1
2	Double Sided Adhesive	001518H130000A	NITTO 5015	White Liner	1

6.1 Adhesive Thickness

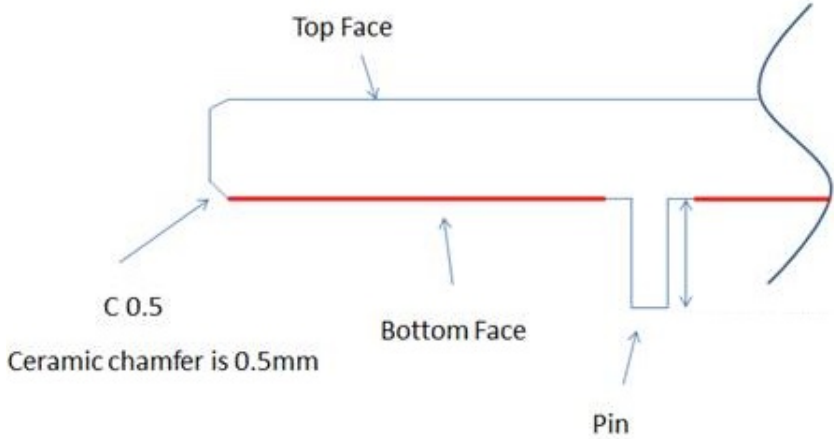

Red Line shows the adhesive without Liner – thickness 0.08~0.1mm

7 PCB Footprint Recommendation

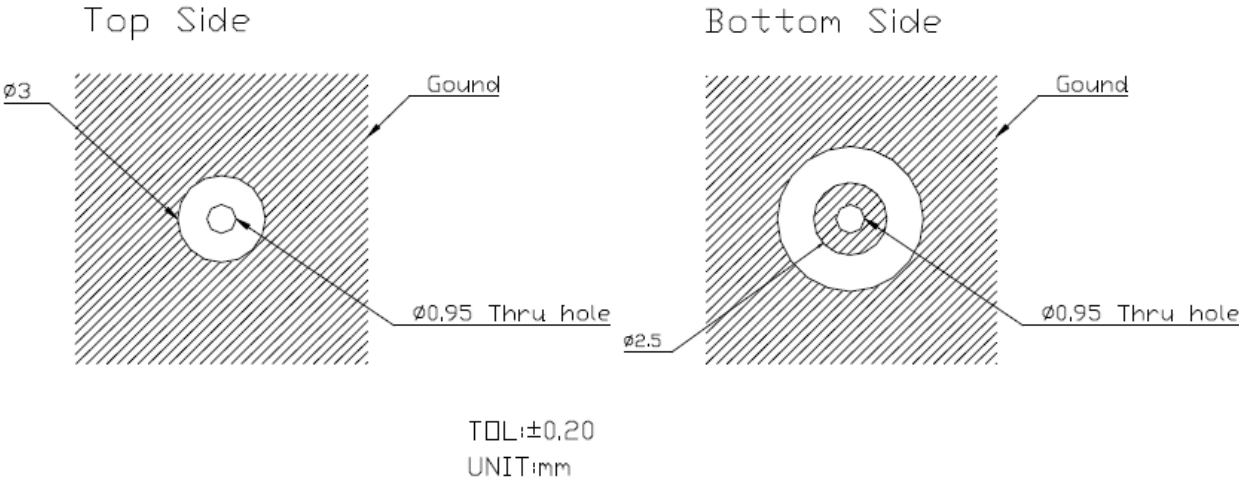

8 Packaging

8 pcs GWSFTP.50.3.A.08 per Tray
 Tray Dimensions - 255*144*8mm
 Weight - 128g

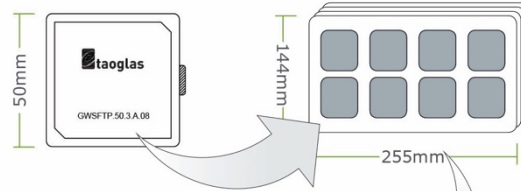

40 pcs GWSFTP.50.3.A.08 per Small Carton
 Carton Dimensions - 263*154*96mm
 Weight - 0.7kg

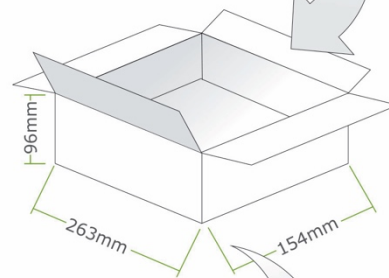

160 pcs GWSFTP.50.3.A.08 per Large Carton
 Large Carton Dimensions - 327*280*218mm
 Weight - 3kg

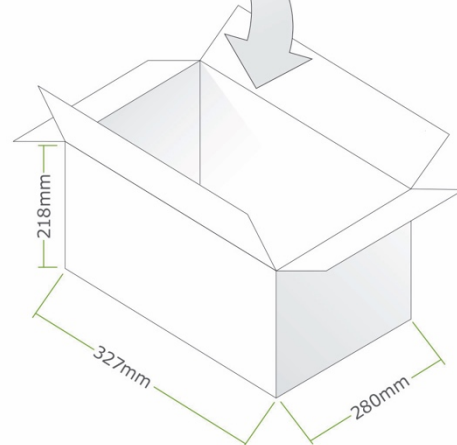

Pallet Dimensions:
 1200mm*1000mm*1280mm
 36 Cartons per Pallet
 9 Cartons per Layer, 4 Layers

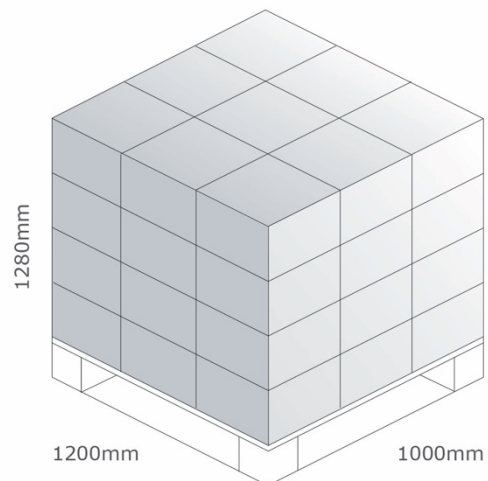

Taoglas makes no warranties based on the accuracy or completeness of the contents of this document and reserves the right to make changes to specifications and product descriptions at any time without notice. Taoglas reserves all rights to this document and the information contained herein.

Reproduction, use or disclosure to third parties without express permission is strictly prohibited.

Copyright © Taoglas Ltd.

X-ON Electronics

Largest Supplier of Electrical and Electronic Components

Click to view similar products for [Antennas](#) category:

Click to view products by [Taoglas](#) manufacturer:

Other Similar products are found below :

[GAN30084EU](#) [930-033-R](#) [GW17.07.0250E](#) [1513563-1](#) [EXE902SM](#) [APAMPG-117](#) [MAF94383](#) [W3908B0100](#) [W6102B0100](#) [YE572113-30RSMM](#) [108-00014-50](#) [66089-2406](#) [SPDA17RP918](#) [A09-F8NF-M](#) [A09-F5NF-M](#) [RGFRA1903041A1T](#) [W3593B0100](#) [W3921B0100](#) [SIMNA-868](#) [SIMNA-915](#) [SIMNA-433](#) [W1044](#) [W1049B090](#) [A75-001](#) [WTL2449CQ1-FRSMM](#) [CPL9C](#) [EXB148BN](#) [0600-00060](#) [TRA9020S3PBN-001](#) [Y4503](#) [GD5W-28P-NF](#) [MA9-7N](#) [GD53-25](#) [GD5W-21P-NF](#) [C37](#) [MAF94051](#) [MA9-5N](#) [EXD420PL](#) [B1322NR](#) [QWFTB120](#) [MAF94271](#) [MAF94300](#) [GPSMB301](#) [FG4403](#) [AO-AGSM-OM54](#) [5200232](#) [MIKROE-2349](#) [WCM.01.0111](#) [MIKROE-2393](#) [MIKROE-2352](#)