

SPECIFICATION

IS.04 868MHz Hercules ISM Band Antenna

Part No.	IS.04.B.301111
Product Name	868MHz Hercules ISM Band Antenna Screw-mount (Permanent mount)
Features	Low profile-Height 29mm and diameter 49mm Heavy duty screw mount UV and Vandal resistant PC housing Standard cable is 3m RG174 with SMA(M)- connector fully customizable IP65 Rated ROHS & REACH Compliant



1. INTRODUCTION

The 868MHz Hercules ISM antenna is a high-performance steel thread-mount ISM antenna for external use on vehicles and outdoor assets worldwide. Omni-directional high gain across all bands ensures constant reception and transmission. Durable UV resistant PC housing is resistant to vandalism and direct attack. At only 29 mm height it complies with the latest EU height restrictions directives for roof-mounted objects, with a diameter of 52 mm. Designed to not catch on tree-branches. The antenna can be mounted on metal structures.

2. SPECIFICATION

ELECTRICAL					
Standard	ISM				
Band (MHz)	868				
Frequency (MHz)	868-870				
Cable Length (m)	0.3	1.0	2.0	3.0	5.0
Return Loss (dB)	-13.95	-14.09	-13.84	-13.07	-21.93
Efficiency (%)	26.88	43.12	38.52	33.75	20.45
Gain (dBi)	1.17	2.09	1.98	1.98	1.03
Polarization	Linear				
Impedance	50 ohms				
Max Input Power	10 watts				
VSWR	<2.5:1				

***Note:** The return loss, efficiency and gain in the above table, were measured on 30x30 cm metal plate with RG174 cable. For a specific case performance refers to the below plots.

MECHANICAL	
Dimensions	Height = 29 mm and Diameter = 49 mm
Cable length	3m RG174 – Fully Customable
Connector	SMA-Male – Fully Customable
Casing	UV Resistant PC
Base and Thread	Nickel plated steel
Thread Diameter	18 mm
Weather proof gasket	Rubber
Sealant	Rubber Stopper
Waterproof	IP65 Rated
ENVIRONMENTAL	
Corrosion	5% NaCl for 48hrs - Nickel plated steel base and thread
Temperature Range	-40°C to +85°C
Thermal Shock	100 cycles -40°C to +85°C
Humidity	Non-condensing 65°C 95% RH
Shock (Drop Test)	1m drop on concrete 6 axes
Cable Pull	8 Kgf
Weight	152g

***Note:** Specifications may be subject to change

3. TEST SET UP

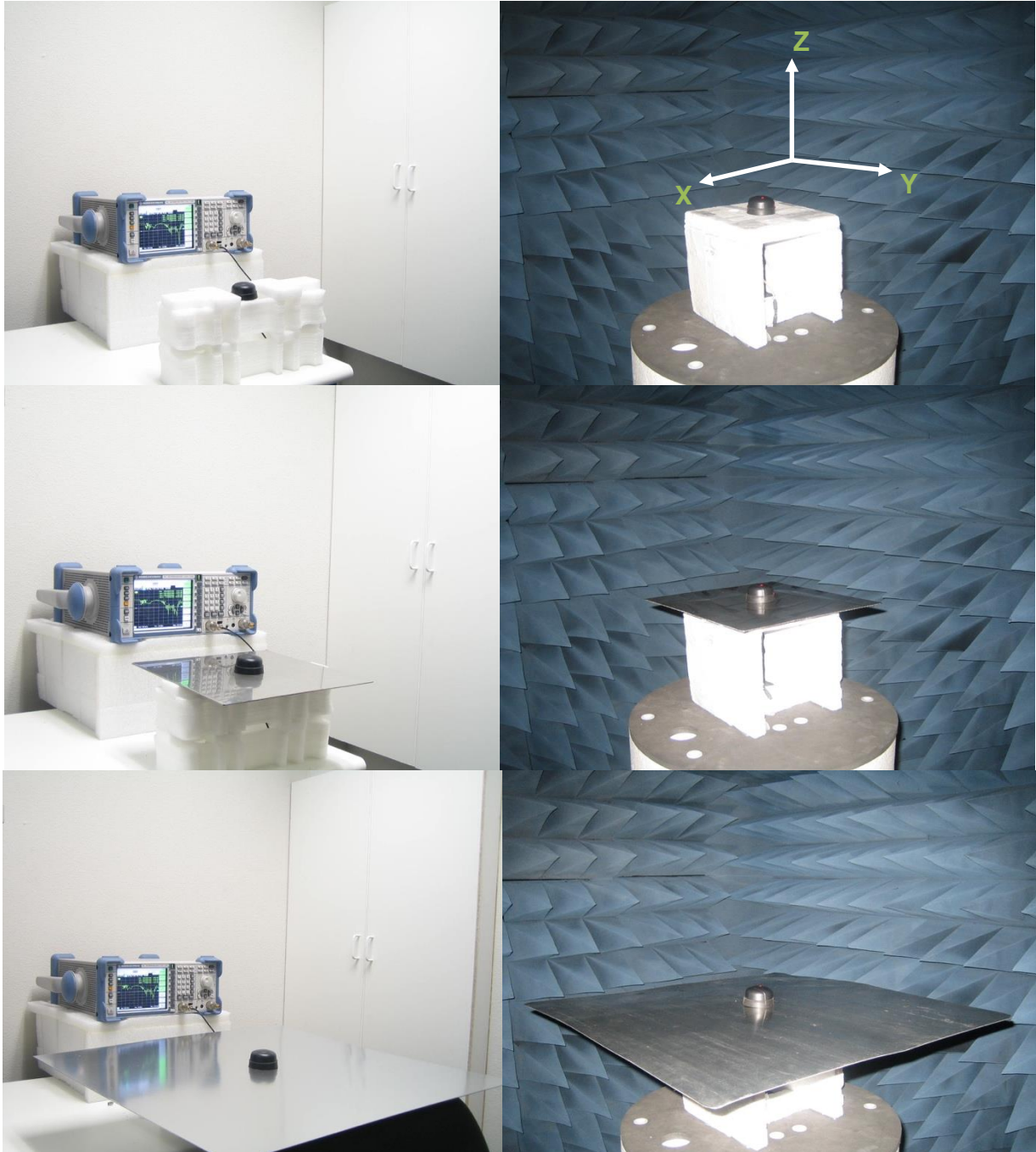

Figure 1. IS.04 Antenna test set up in free space, 30x30 cm metal plate and 60x60 cm metal plate, R&SZVL6 VNA (left) and R&S4100 CTIA 3D Chamber (Right).

4. ANTENNA PARAMETERS

4.1 Return Loss

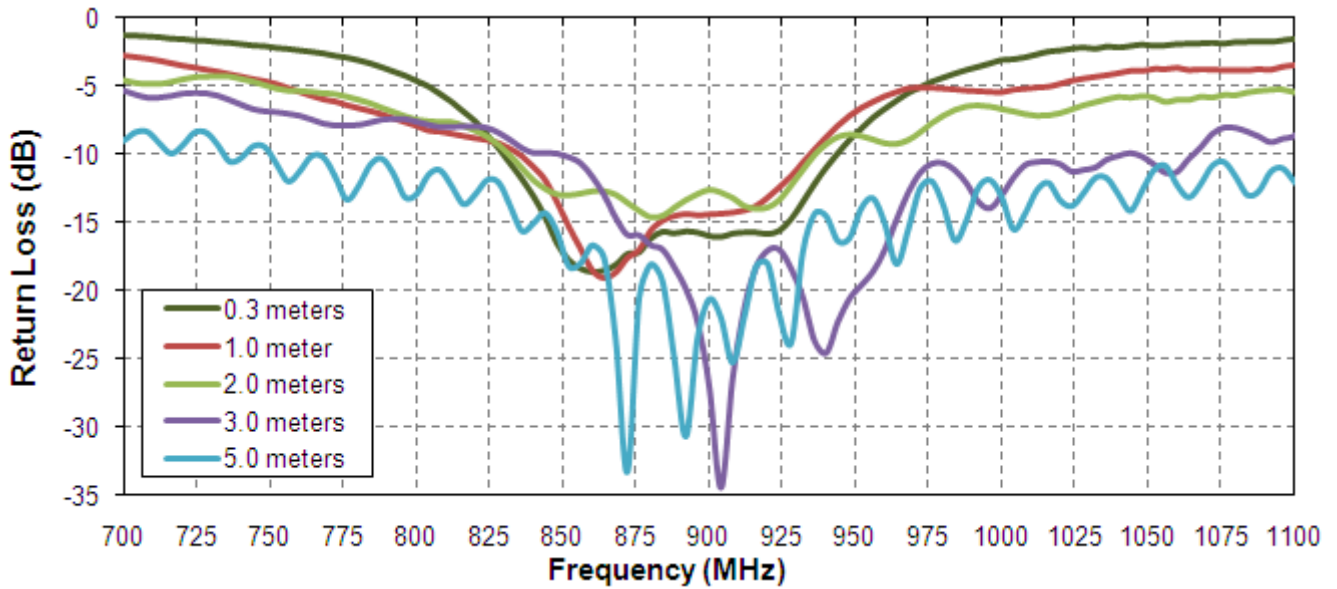

Figure 2. Return Loss of the 868MHz Hercules ISM antenna in free space

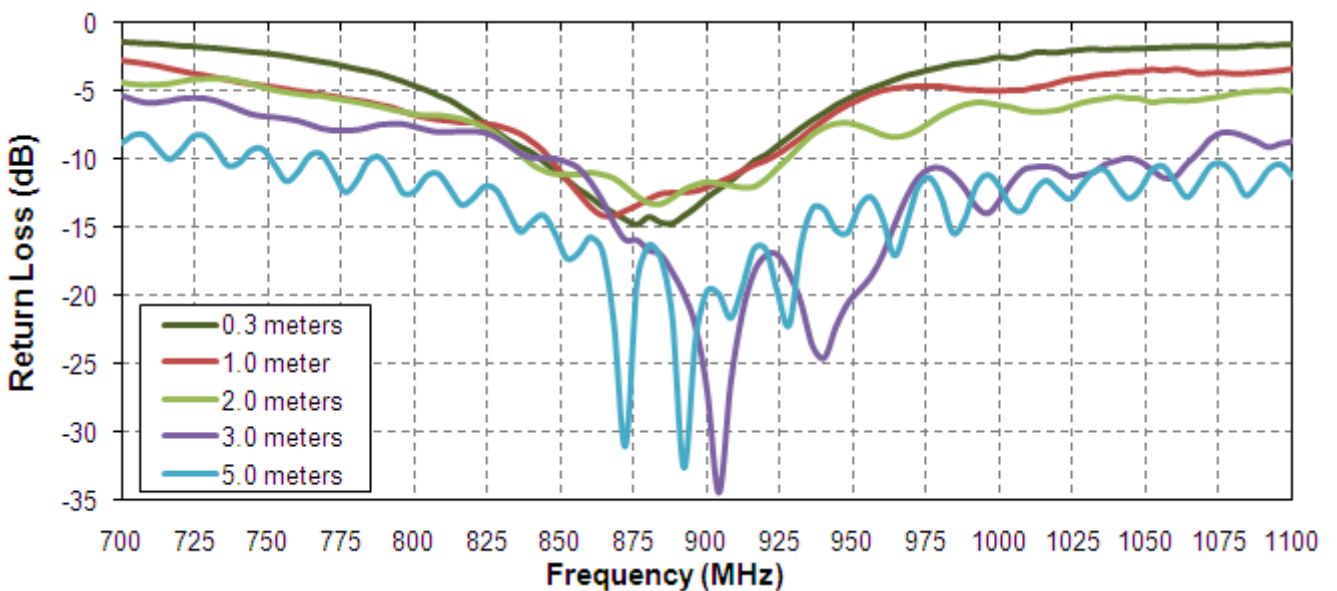

Figure 3. Return loss of the 868MHz Hercules ISM antenna on 30x30 cm metal plate.

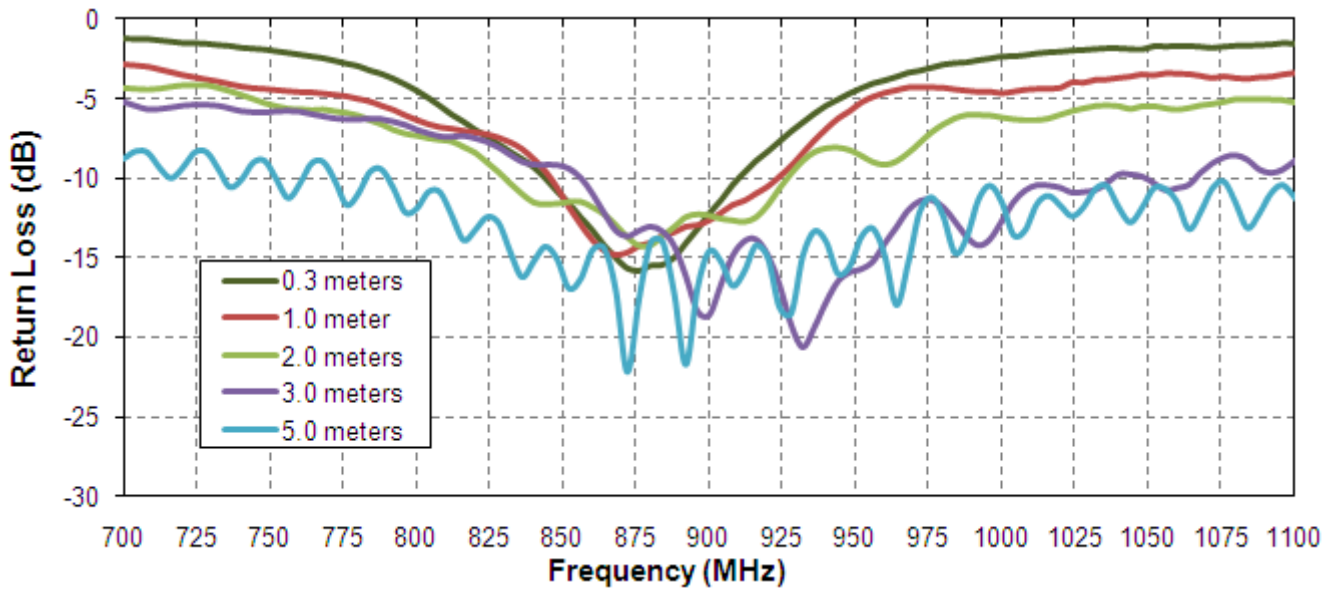

Figure 4. Return loss of the 868MHz Hercules ISM antenna on 60x60 cm metal plate.

4.2 Efficiency

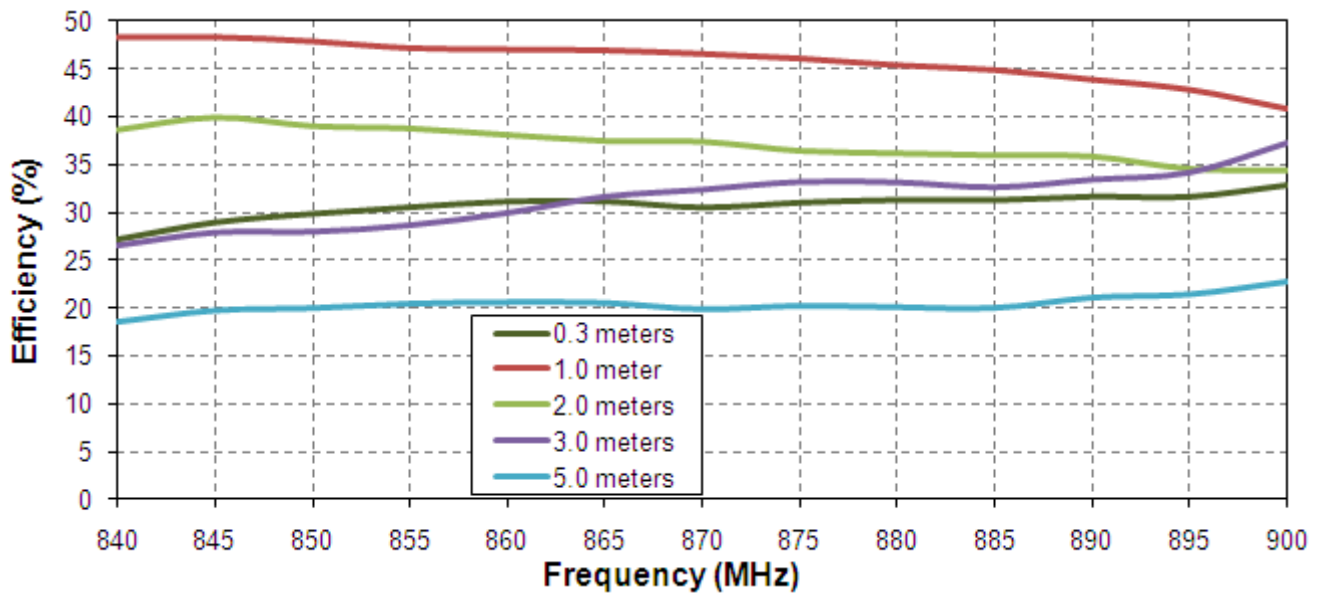

Figure 5. Efficiency of the 868MHz Hercules ISM antenna in free space.

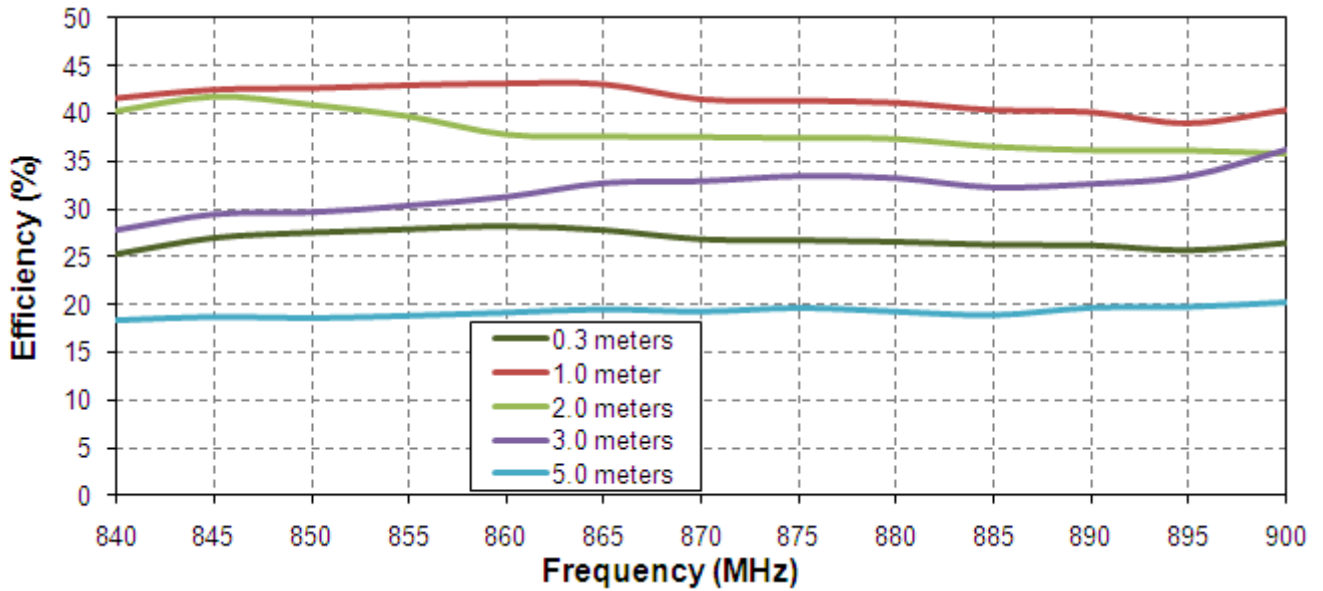

Figure 6. Efficiency of the 868MHz Hercules ISM antenna on 30x30 cm metal plate.

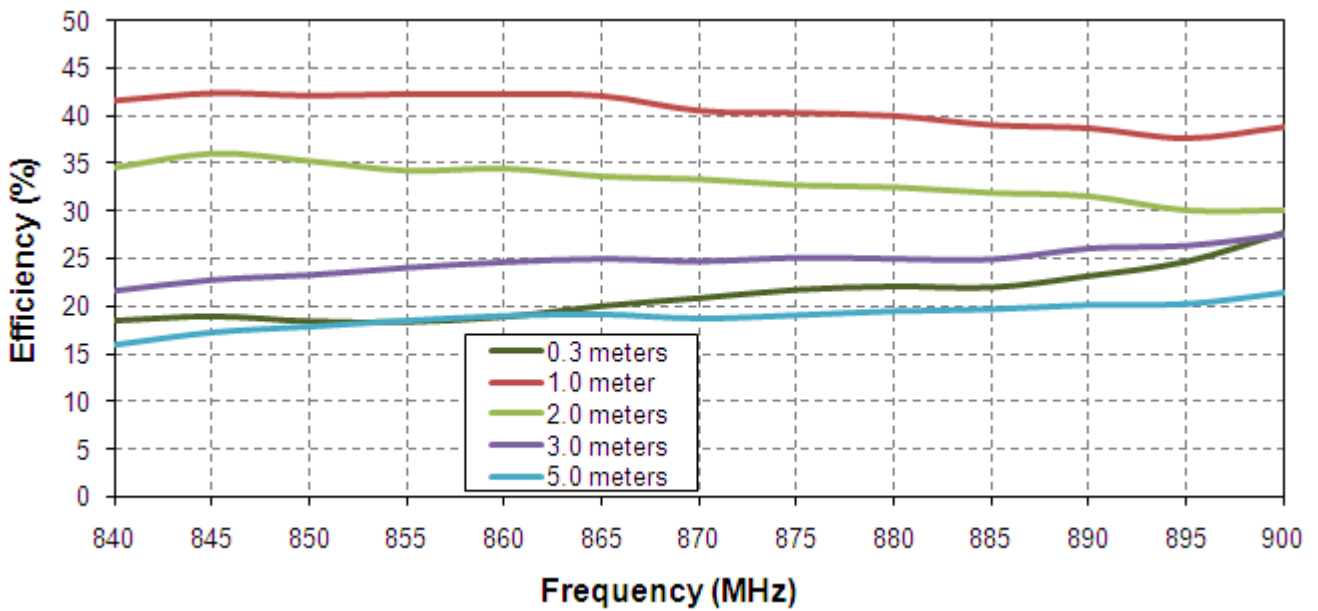

Figure 7. Efficiency of the 868MHz Hercules ISM antenna on 60x60 cm metal plate.

4.3 Gain

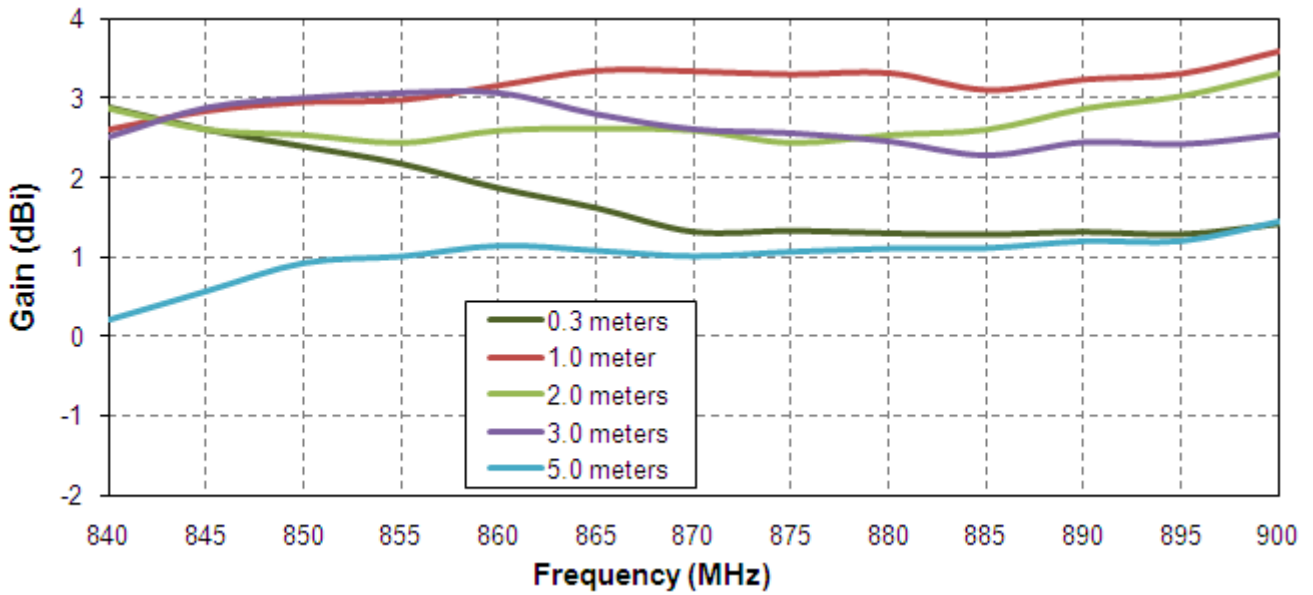

Figure 8. Gain of the 868MHz Hercules ISM antenna in free space.

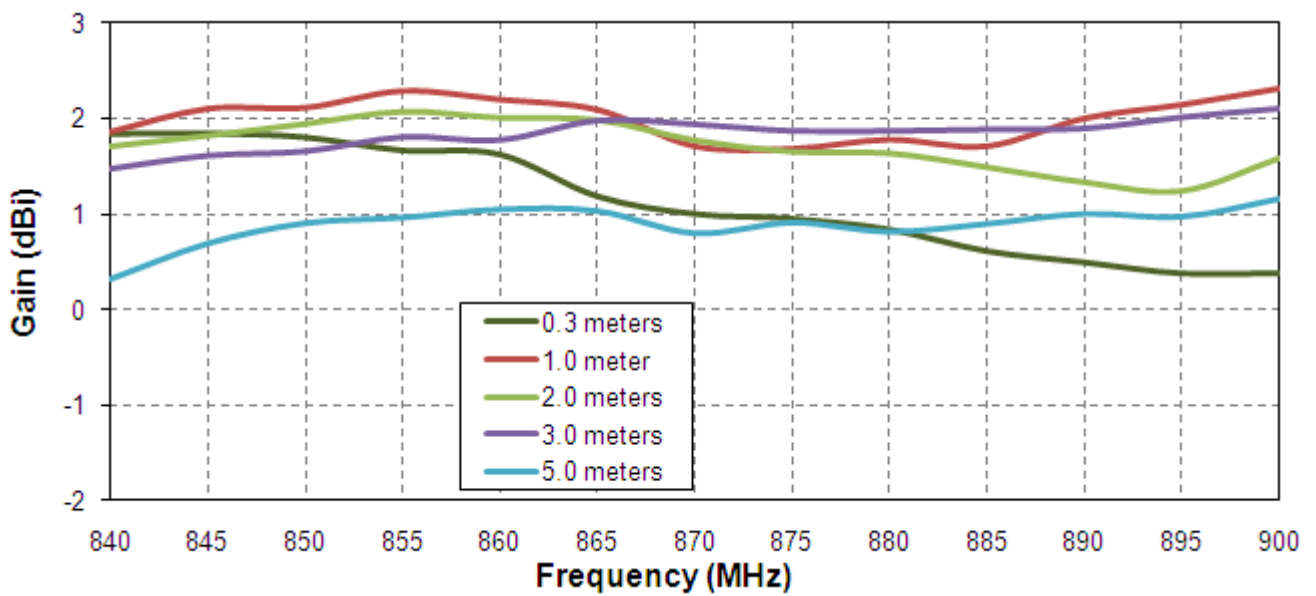

Figure 9. Gain of the 868MHz Hercules ISM antenna on 30x30 cm metal plate.

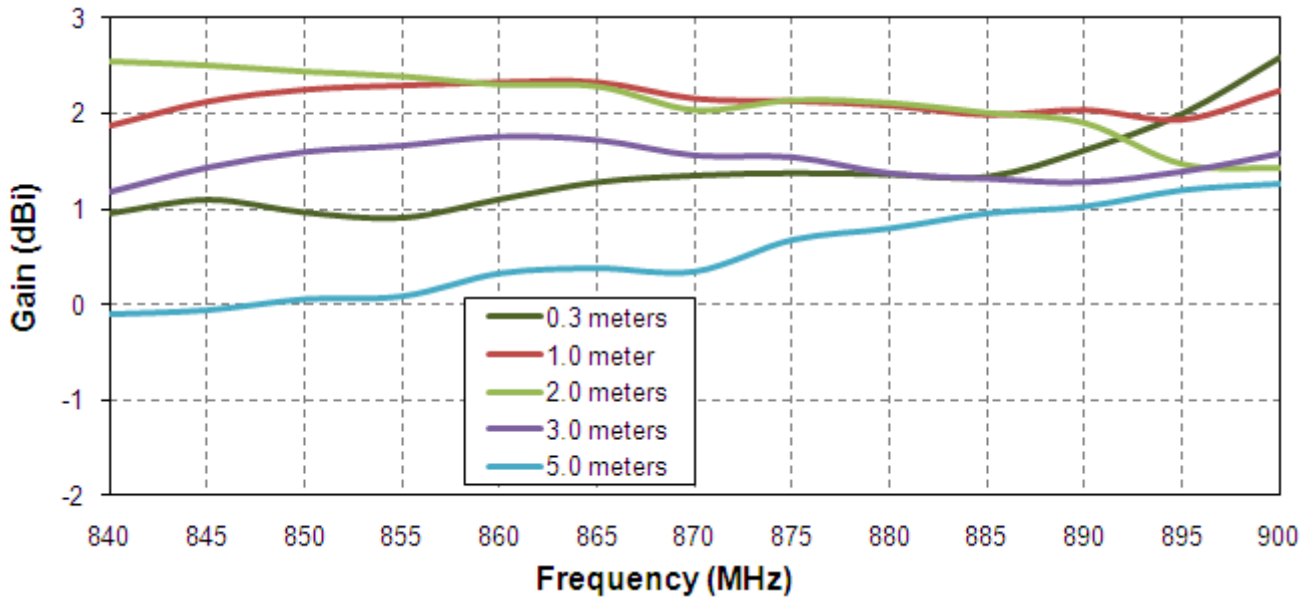

Figure 10. Gain of the 868MHz Hercules ISM antenna on 60x60 cm metal plate.

4.4. Radiation Pattern

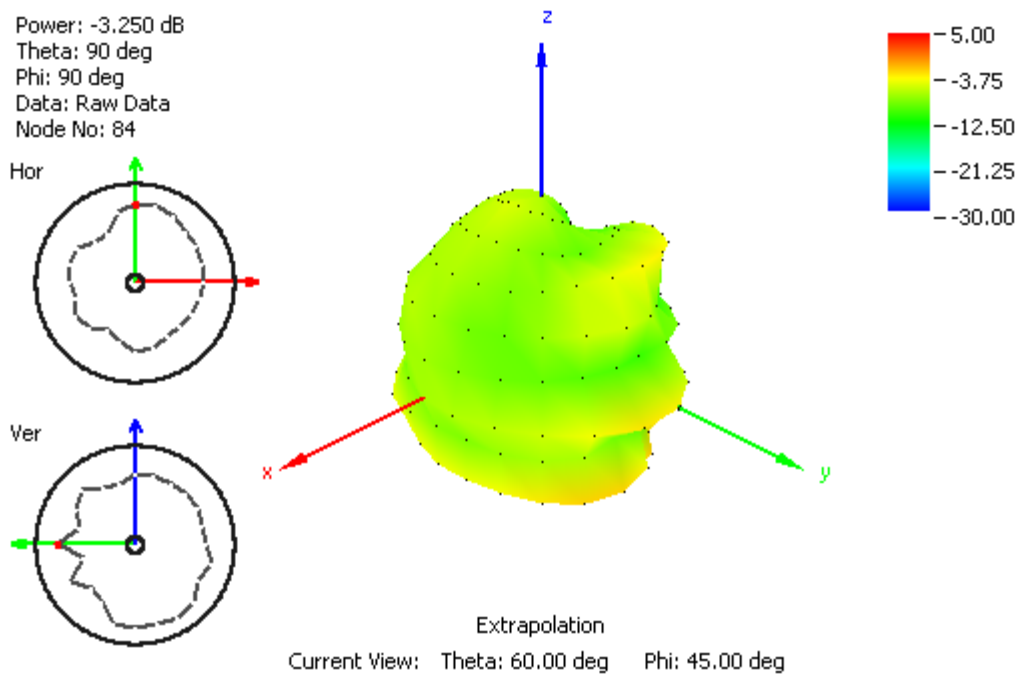

Figure 11. Radiation pattern at 865 MHz, Figure 1 as reference (dB), with 2m RG174 cable and free space.

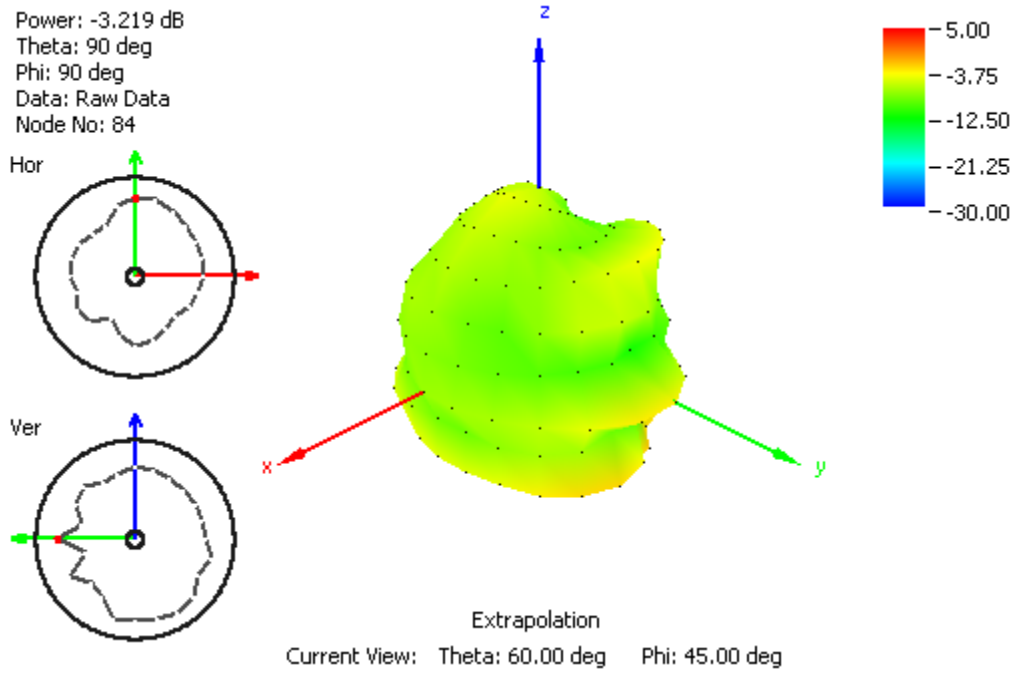

Figure 12. Radiation pattern at 868 MHz, Figure 1 as reference (dB), with 2m RG174 cable and free space.

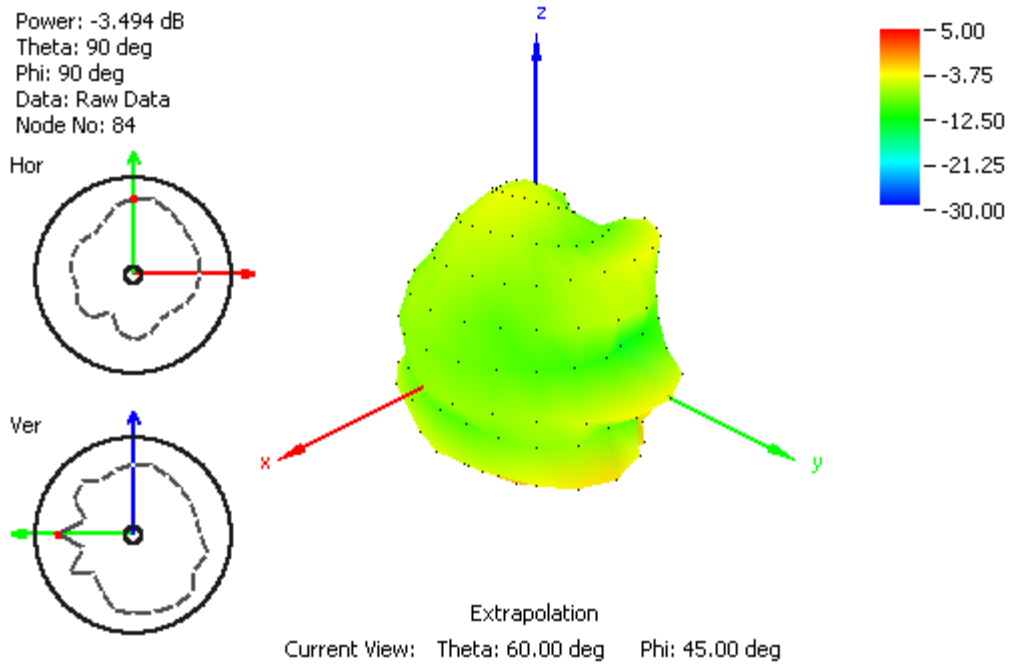

Figure 13. Radiation pattern at 870 MHz, Figure 1 as reference (dB), with 2m RG174 cable free space.

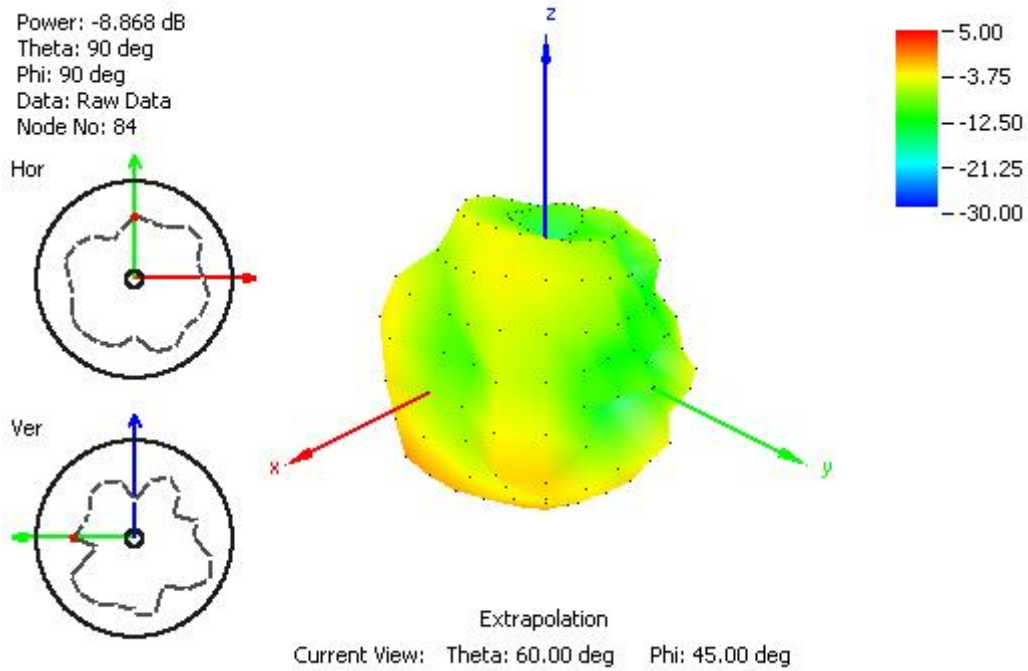

Figure 14. Radiation pattern at 865 MHz,
 Figure 1 as reference (dB), with 2m RG174 cable and 30x30 cm metal plate.

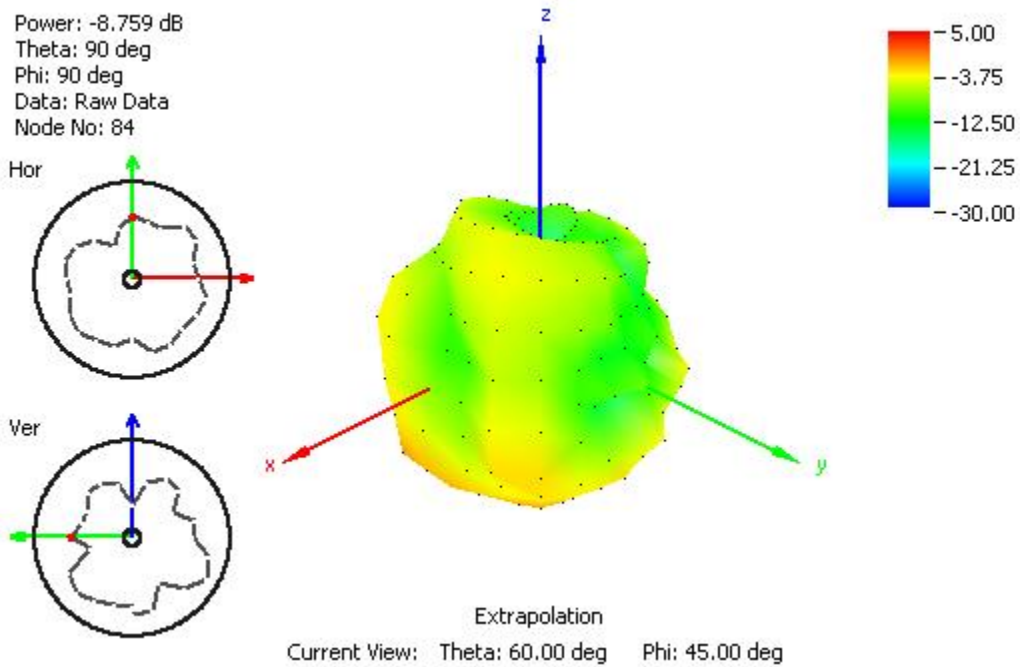

Figure 15. Radiation pattern at 868 MHz,
 Figure 1 as reference (dB), with 2m RG174 cable and 30x30 cm metal plate.

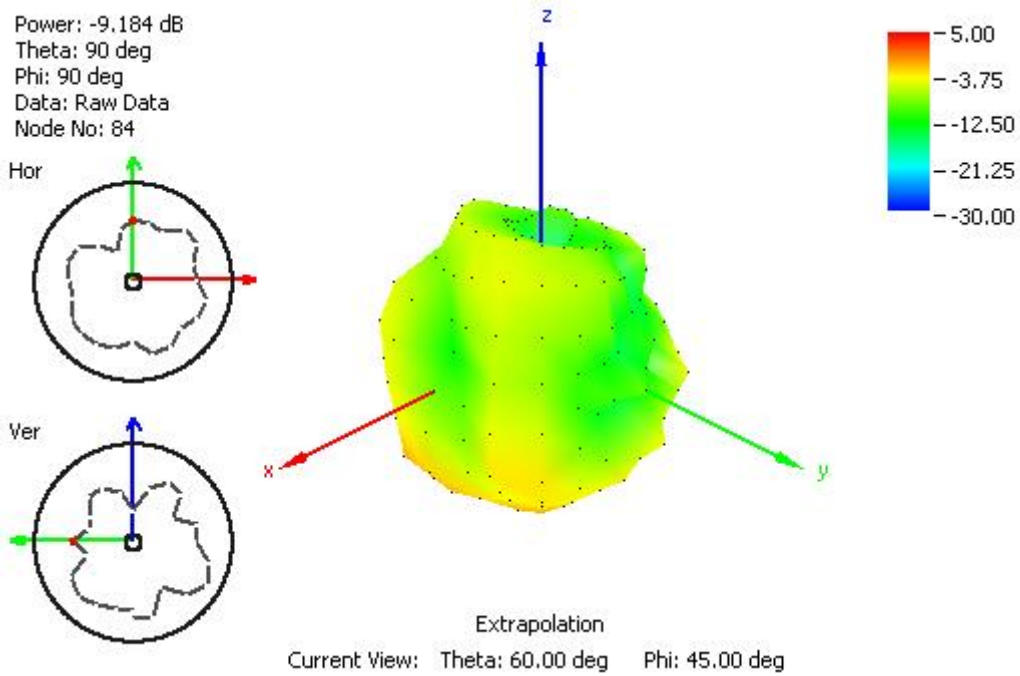

Figure 16. Radiation pattern at 870 MHz, Figure 1 as reference (dB), with 2m RG174 cable 30x30 cm metal plate.

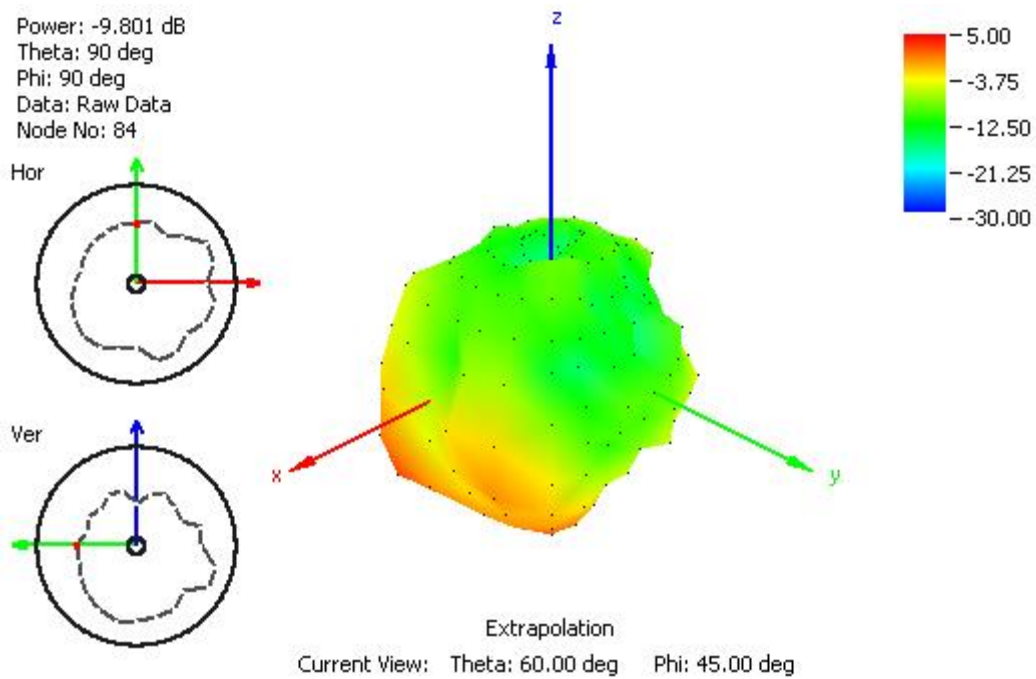

Figure 17. Radiation pattern at 865 MHz, Figure 1 as reference (dB), with 2m RG174 cable and 60x60 cm metal plate.

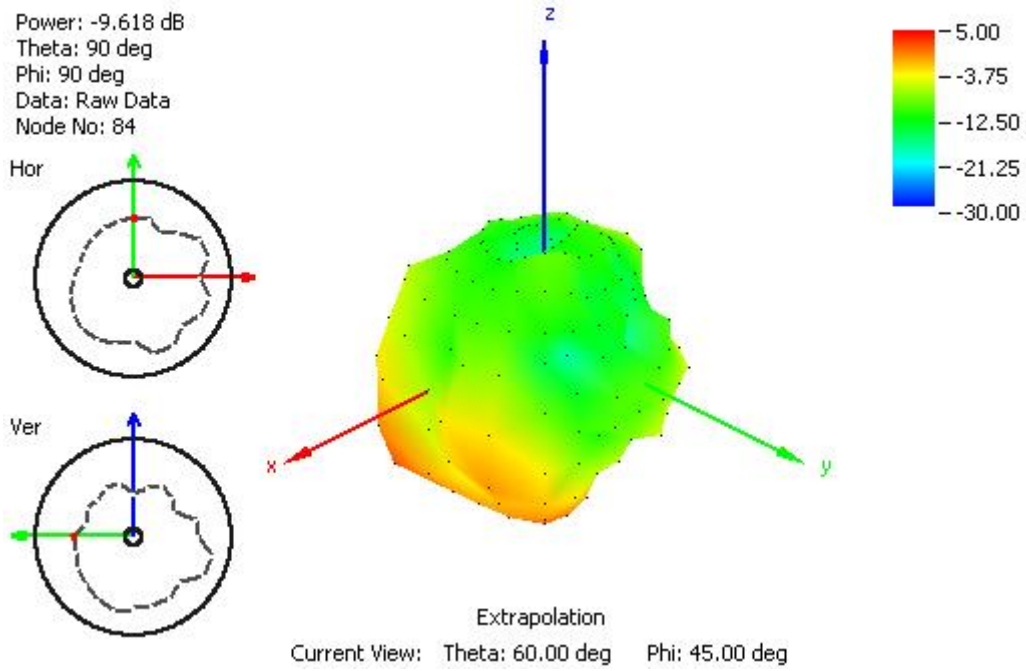

Figure 18. Radiation pattern at 868 MHz, Figure 1 as reference (dB), with 2m RG174 cable and 60x60 cm metal plate.

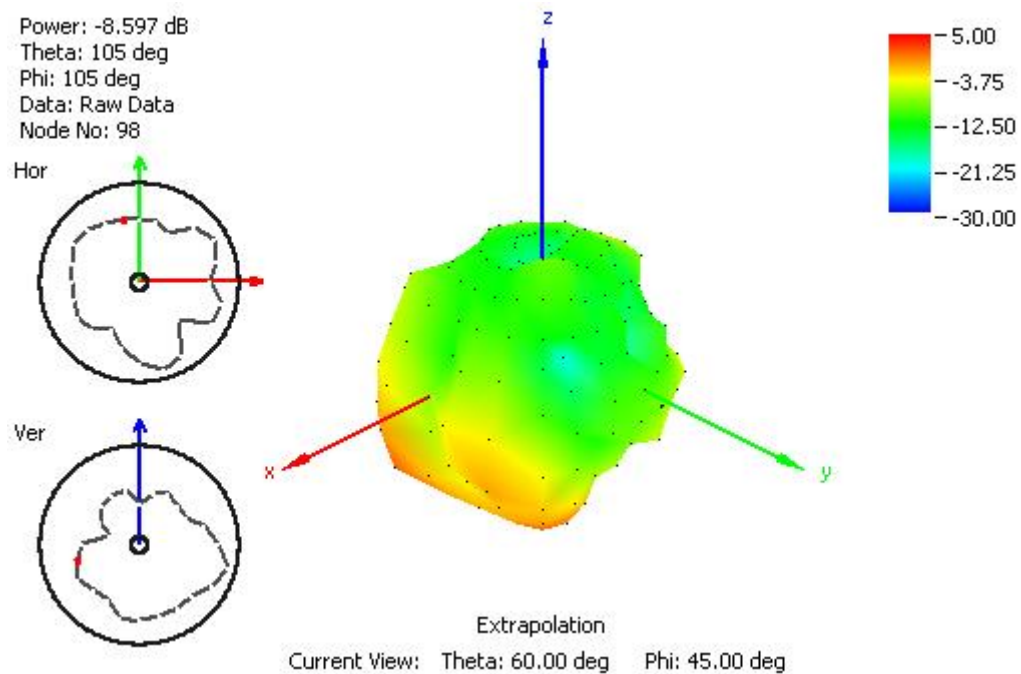
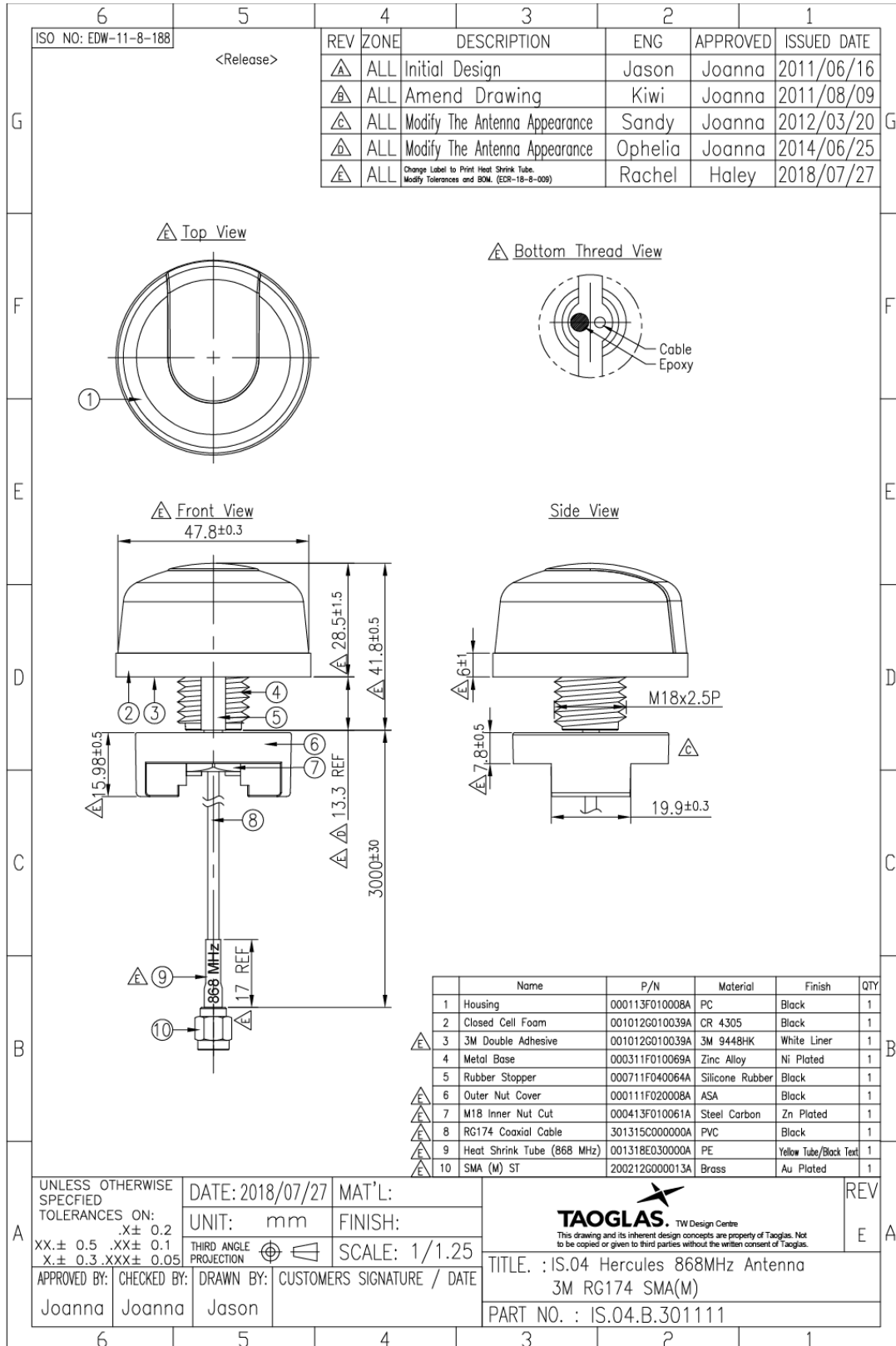
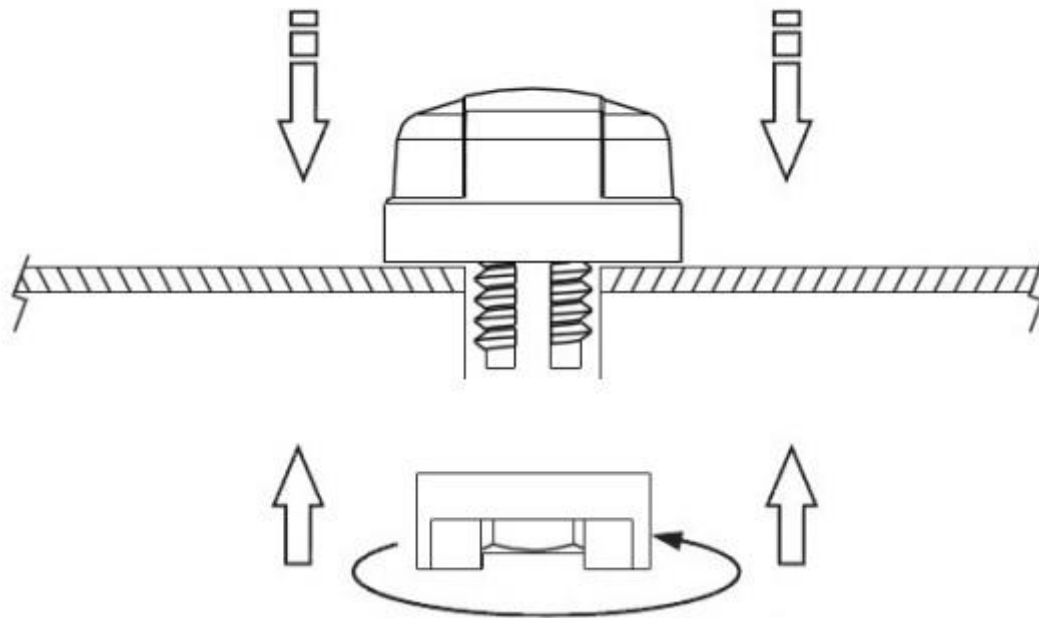

Figure 19. Radiation pattern at 870 MHz, Figure 1 as reference (dB), with 2m RG174 cable 60x60 cm metal plate.

5. MECHANICAL DRAWINGS



6. INSTALLATION



7. PACKAGING

1pc IS.04.B.301111 per Small PE Bag
Dimensions: 100*300mm
Weight: 158g

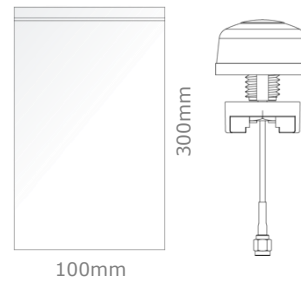

10pcs per Large PE Bag
Dimensions: 360*520mm
Weight: 1.58Kg



60pcs IS.04.B.301111 per Carton
Carton Dimensions: 430*380*280mm
Weight: 9.5Kg

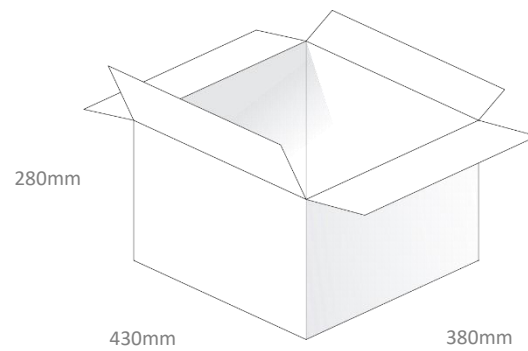

Taoglas makes no warranties based on the accuracy or completeness of the contents of this document and reserves the right to make changes to specifications and product descriptions at any time without notice. Taoglas reserves all rights to this document and the information contained herein.

Reproduction, use or disclosure to third parties without express permission is strictly prohibited.

© Taoglas

X-ON Electronics

Largest Supplier of Electrical and Electronic Components

Click to view similar products for [Antennas](#) category:

Click to view products by [Taoglas](#) manufacturer:

Other Similar products are found below :

[GAN30084EU](#) [930-033-R](#) [GW17.07.0250E](#) [1513563-1](#) [EXE902SM](#) [APAMPG-117](#) [MAF94383](#) [W3908B0100](#) [W6102B0100](#) [YE572113-30RSMM](#) [108-00014-50](#) [66089-2406](#) [SPDA17RP918](#) [A09-F8NF-M](#) [A09-F5NF-M](#) [RGFRA1903041A1T](#) [W3593B0100](#) [W3921B0100](#) [SIMNA-868](#) [SIMNA-915](#) [SIMNA-433](#) [W1044](#) [W1049B090](#) [A75-001](#) [WTL2449CQ1-FRSMM](#) [CPL9C](#) [EXB148BN](#) [0600-00060](#) [TRA9020S3PBN-001](#) [Y4503](#) [GD5W-28P-NF](#) [MA9-7N](#) [GD53-25](#) [GD5W-21P-NF](#) [C37](#) [MAF94051](#) [MA9-5N](#) [EXD420PL](#) [B1322NR](#) [QWFTB120](#) [MAF94271](#) [MAF94300](#) [GPSMB301](#) [FG4403](#) [AO-AGSM-OM54](#) [5200232](#) [MIKROE-2349](#) [WCM.01.0111](#) [MIKROE-2393](#) [MIKROE-2352](#)