

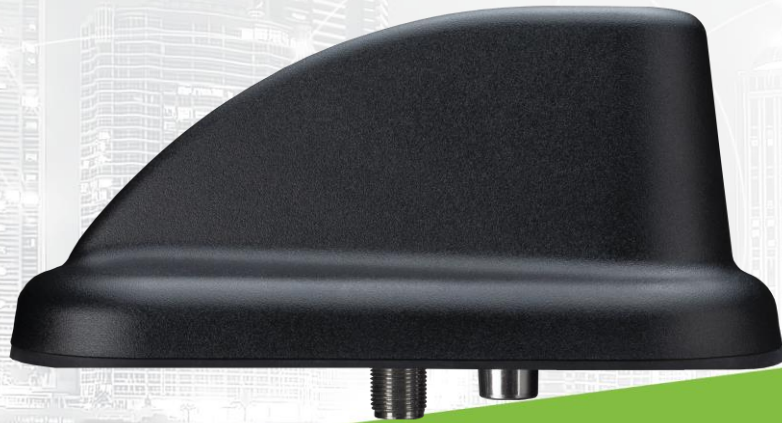

TAOGLAS®



Datasheet

4 in 1 Sharkfin Antenna

Part No:
MA1044.A.ACTX.002

Description:

MA1044 - 4in1 Sharkfin Antenna GNSS, Wi-Fi, AM/FM & SDARS

Features:

Combination Sharkfin Style Antenna

Permanent Mount

1* GNSS: 300mm RG-316 with FAKRA Code C Blue

1* Wi-Fi: 300mm RG-316 with FAKRA Code I Beige

1* SDARS: 300mm RG-316 with FAKRA Code K Curry

1* AM/FM: 300mm RG-316 with FAKRA Code A Black

Cable and Connectors Customizable

IP65 Rated Waterproof

Manufactured in TS16949 Automotive Approved Facilities

RoHS & Reach Compliant

1. Introduction	3
2. Specifications	4
3. Antenna Characteristics	6
4. Radiation Patterns	15
5. Mechanical Drawing	28
6. Packaging	29
<hr/>	
Changelog	30

Taoglas makes no warranties based on the accuracy or completeness of the contents of this document and reserves the right to make changes to specifications and product descriptions at any time without notice. Taoglas reserves all rights to this document and the information contained herein.

Reproduction, use or disclosure to third parties without express permission is strictly prohibited.



1. Introduction



The Taoglas MA1044.A Sharkfin is a next generation 4in1, vehicle roof permanent mount combination antenna solution. It is a fully IP67 rated waterproof antenna manufactured with a robust ABS/PC enclosure. The antenna is approved for use on heavy-duty trucks and meets the strictest OEM heavy-duty truck standards. It supports multiple GNSS constellations, GPS, GLONASS, GALILEO & BeiDou), Dual Band Wi-Fi (2.4/5.8GHz), SDARS, and AM/FM/WB.

The antenna is first tier TS16949 heavy-duty truck approved and is an ideal choice for OEM automotive, trucking and heavy equipment applications.

The antenna comes with low-loss RG-174 coaxial pigtail cables as standard, terminating in FAKRA SMB code C for GNSS, FAKRA SMB code A for AM/FM/WB, FAKRA SMB code K for SDARS, and with FAKRA SMB code I for Wi-Fi. The SDARS antenna meets the latest (Gen 3) specifications. The AM/FM/WB antenna has an in-built amplifier to increase receive signal sensitivity.

The antenna works in conjunction with a 12v DC wire that powers the AM/FM/WB circuits. The internal antennas can be completely customized according to specific requirements, to work on other applications, such as ISM bands or C-V2X / DSRC. The antenna is manufactured in TS16949 automotive approved facilities.

Cables and connectors are customizable, contact your local Taoglas customer service team for more information or installation guidelines.

2. Specifications

GNSS Antenna	
Frequency	GPS: 1575.42 ± 1.023MHz GLONASS: 1602 ± 5MHz
Return loss (GPS L1 GLONASS L1)	<-15 dB
Efficiency	60%
Passive Gain at Zenith (GPS L1 and GLONASS L1)	+3 dBi.
Average Gain at (GPS L1 and GLONASS L1)	-2dB
Polarization	RHCP
Impedance	50 Ω

SDARS Antenna	
Frequency	2320~2345MHz
Return loss	<-5 dB
Efficiency	48%+
Peak Gain	+4dBi.
Average Gain	> -3dB
Polarization	LHCP
Impedance	50 Ω

Wi-Fi Antenna		
Frequency	2400-2500MHz	5000-5830MHz
Return loss	-15 dB	-10 dB
Efficiency	70%+	50%+
Peak Gain	4.5dBi	6dBi typ
Average Gain	-1.3dB	> -3dB
Impedance	50 Ω	

AM/FM Antenna	
AM Radio Bands	FM Radio Bands
535~1605KHz	88~108MHz

Mechanical	
Dimensions	183.64*80.91*77.27 mm
Cable	GNSS: 300mm RG-316 Wi-Fi: 300mm RG-316 SDARS: 300mm RG-316 AM/FM: 300mm RG-316
Connector	GNSS: FAKRA Code C Blue Wi-Fi: FAKRA Code I Beige SDARS: FAKRA Code K Curry AM/FM: FAKRA Code A Black
Casing	ASA+PC w/UV Stabilizer
Weight	0.44kg
Environmental	
IP Rating	IP65
Temperature Range	-40°C to 85°C
Thermal Shock	IEC 60068-2-14
Humidity	Non-condensing 65°C 95% RH
Cable Pull	35.59N
Recommended Mounting Torque	10.17Nm +/- 20%
Maximum Mounting Torque	13.56Nm

3. Antenna Characteristics

3.1 AM/FM

Return Loss

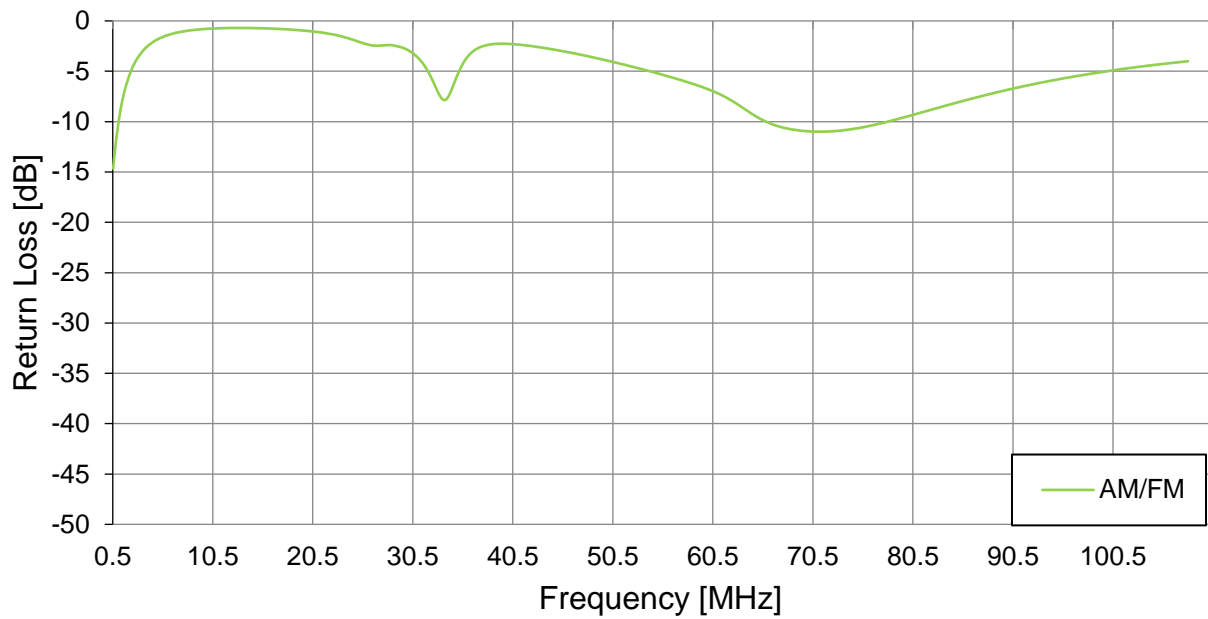

3.2 GNSS

Return Loss

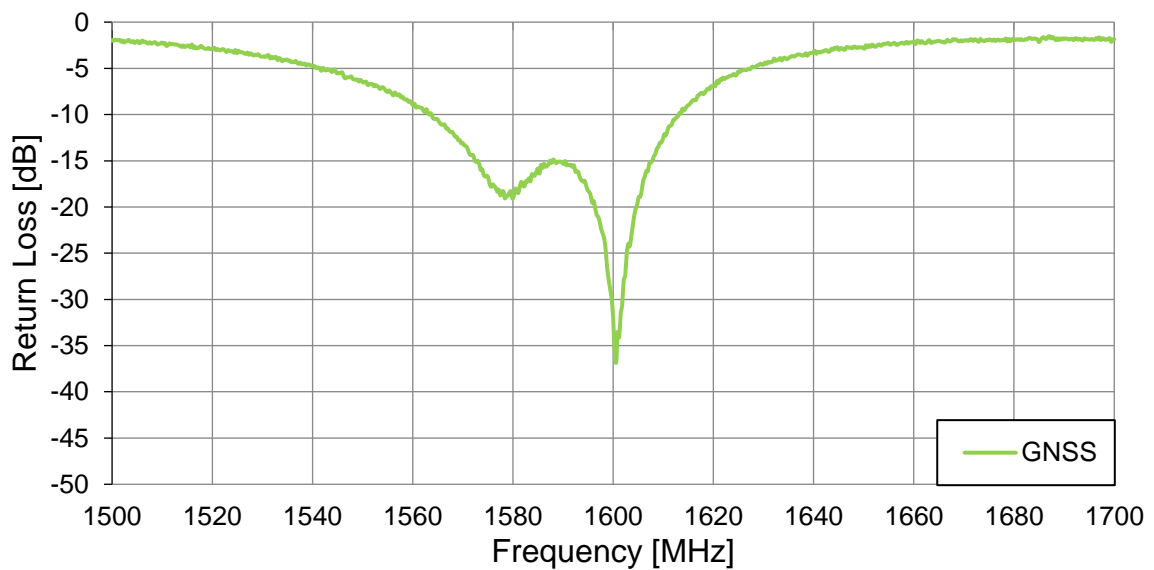

Efficiency

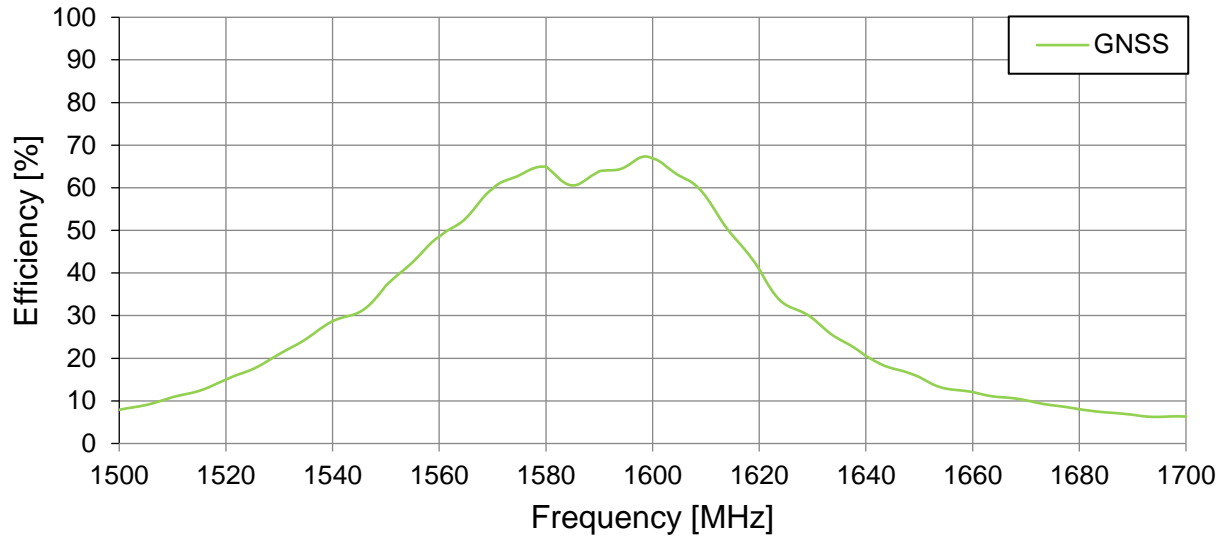

Average Gain

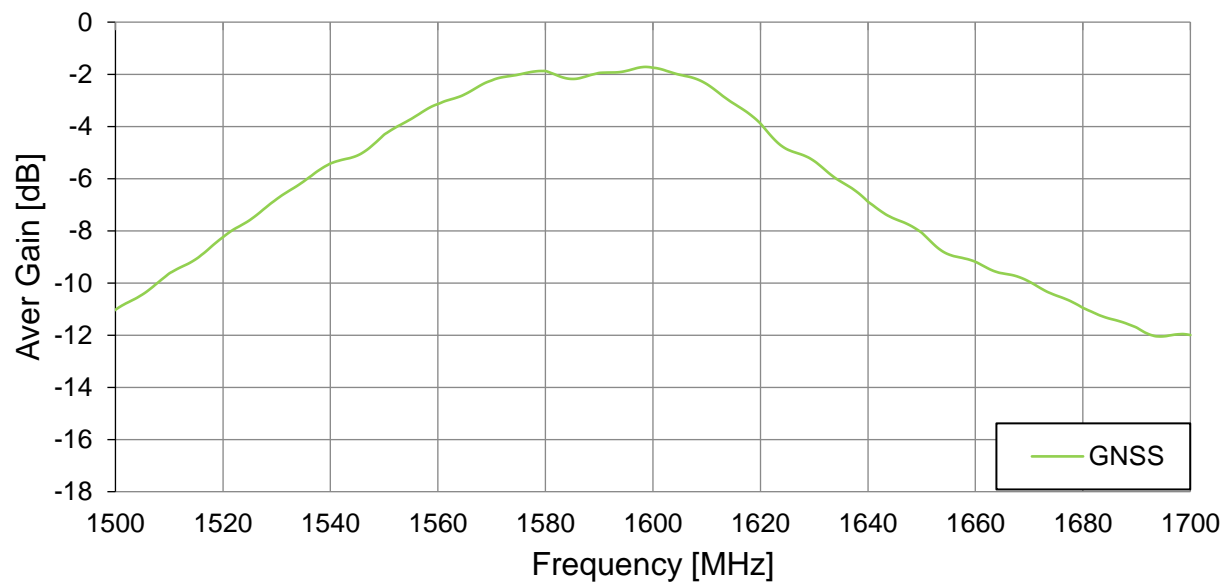

Peak Gain

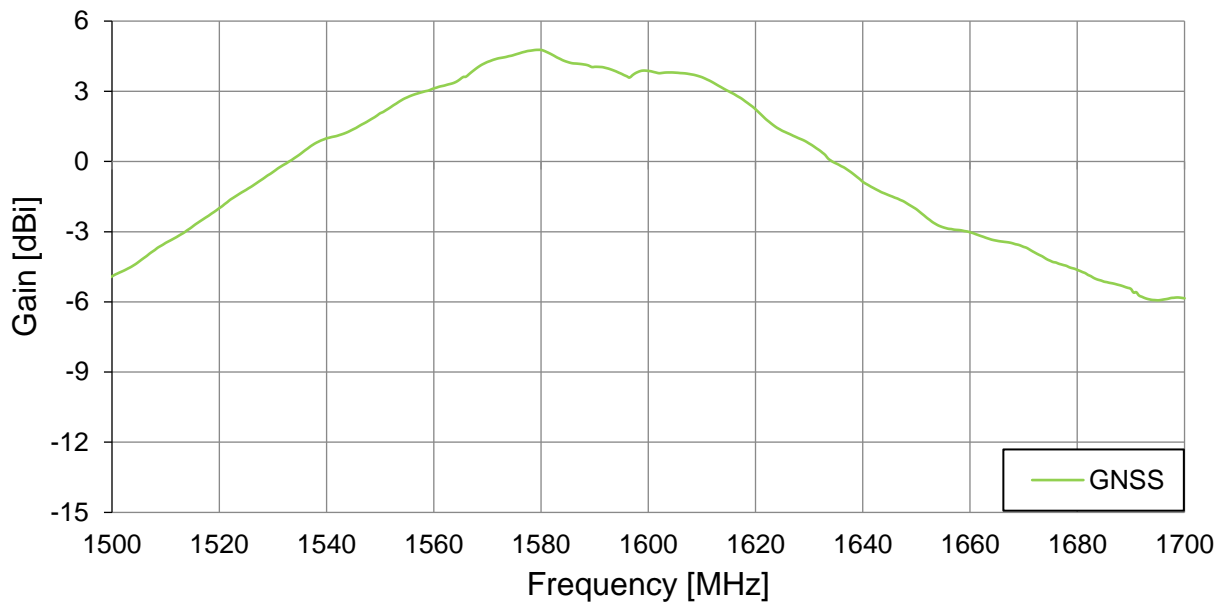

Axial Ratio XZ Plane @ 1575.5MHz

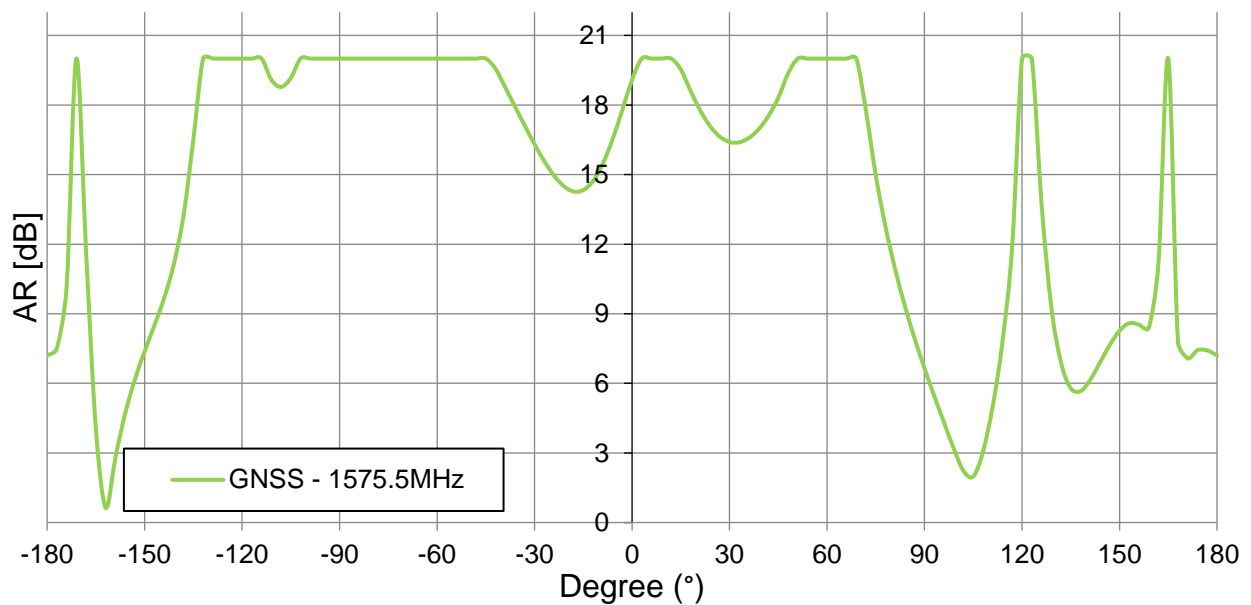

Axial Ratio YZ Plane @ 1575.5MHz

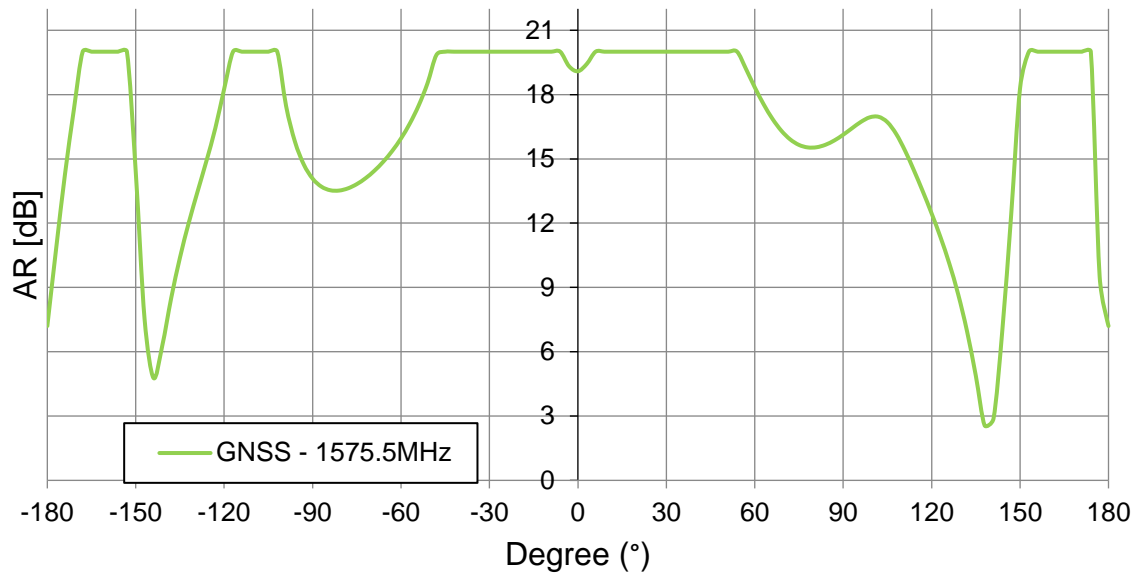

Amplifier		
LNA-10	Frequency Range	1584.5±25MHz
LNA-20	Gain	31dB Typ
LNA-30	Noise Figure	1.5dB Typ
LNA-40	Output 1dB CP	10.0 dBm Typ
LNA-50	Out Band Rejection	f_0 : 1584.5MHz
		$f_0 \pm 20$ MHz N/A
		$f_0 \pm 50$ MHz 30dB Min
		$f_0 \pm 100$ MHz 40dB Min
LNA-60	Output SWR	2:1 Max
Power		
POW-10	Input Voltage	3.5 ~ 5V
POW-20	Current	30mA Typ

3.3 SDARS Antenna

Return Loss

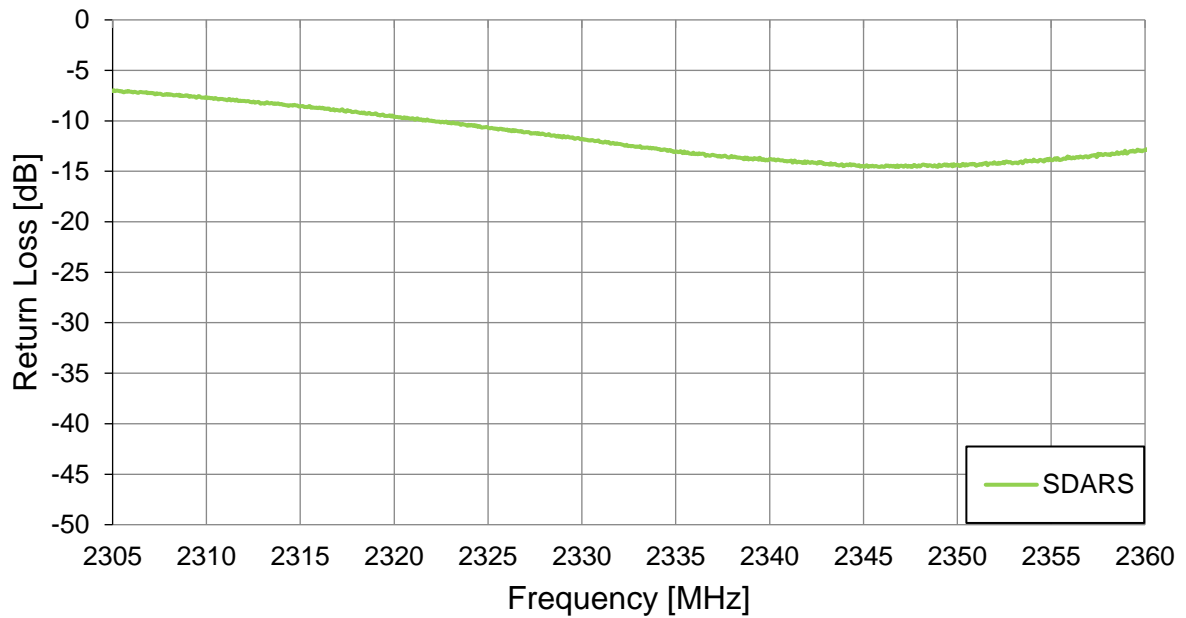

Efficiency

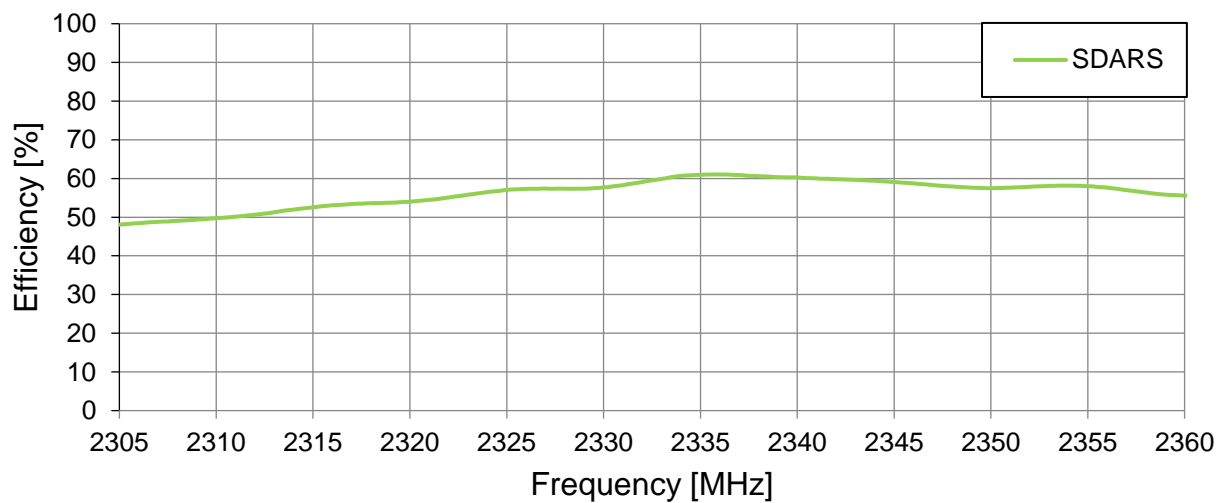

Average Gain

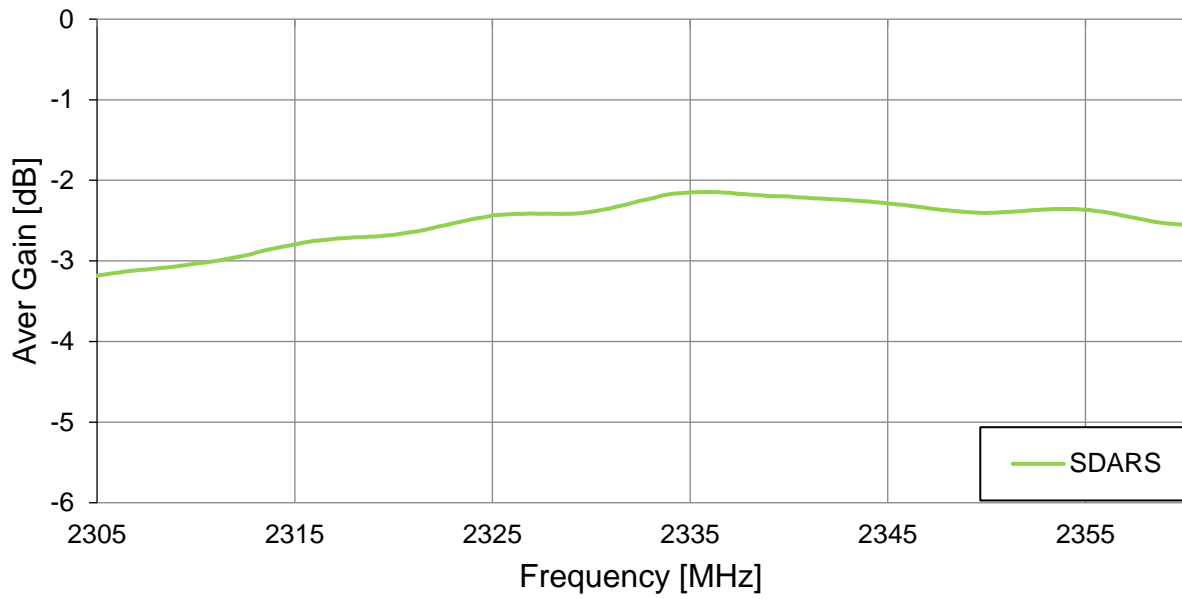

Peak Gain

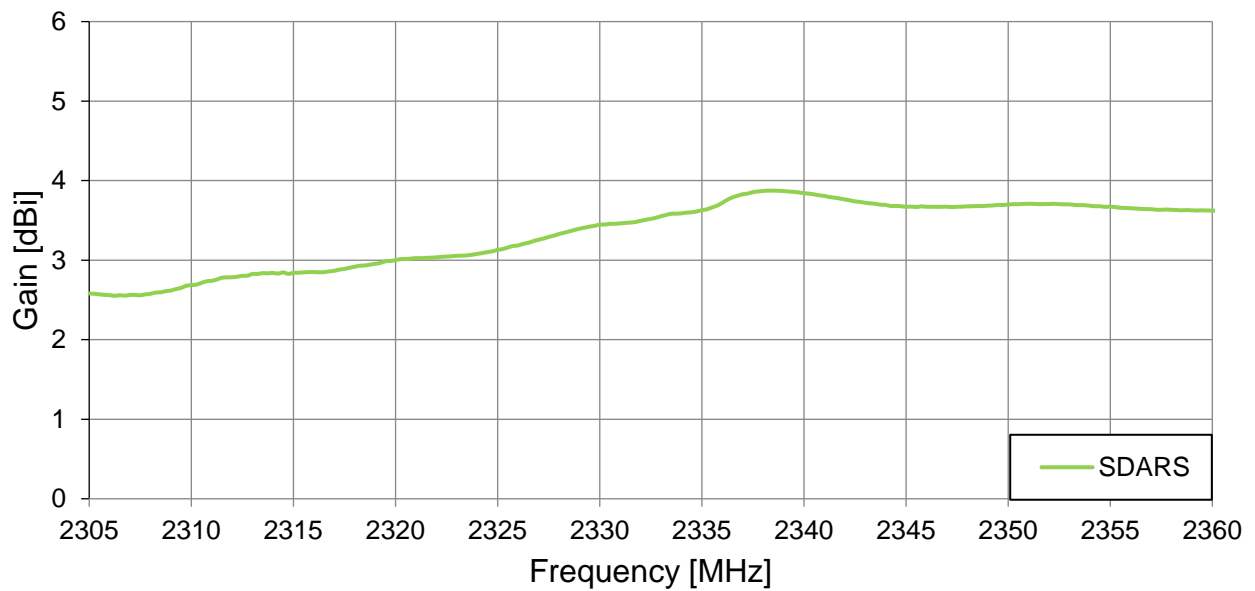

Amplifier		
LNA-10	Frequency Range	2332.5±12.5MHz
LNA-20	Gain	29dB Typ
LNA-30	Noise Figure	1.1 dB Typ
LNA-40	Output 1dB CP	18.0 dBm Typ
LNA-50	Out Band Rejection	f ₀ : 2332.5MHz
		High LTE/4G/3G Rejection
		WCS Rejection
		High Wi-Fi Rejection
LNA-60	Output SWR	2:1 Max
Power		
POW-10	Input Voltage	4.5 ~ 5.5V
POW-20	Current	110 mA Typ

Amplifier		
LNA-10	Frequency Range	520 KHz–1610 KHz, 88-108 MHz, 162.40-162.55 MHz
LNA-20	AM Gain	0.5 dB Typ @ 50 Ohm
LNA-30	FM Gain	16 dB Typ
LNA-40	WB Gain	14 dB Typ
LNA-60	FM/WB Noise Figure	3.5dB Typ
LNA-70	AM Noise Figure	N/A
LNA-80	FM/WB Output 1dB CP	12dBm
LNA-80	AM Output 1dB CP	127dBuV typ
LNA-90	AM Output SWR	N/A
LNA-100	FM/WB Output SWR	3:1 Max
Power		
POW-10	Input Voltage	10 ~ 16V
POW-20	Current	50 mA Typ

3.4 Wi-Fi Antenna

Return Loss

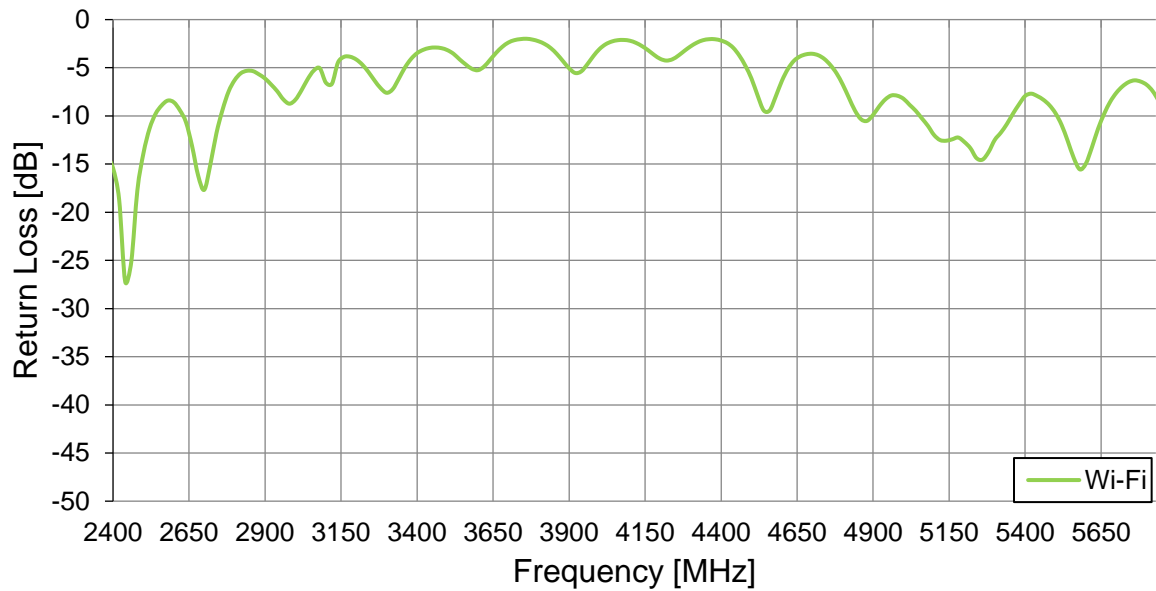

Efficiency

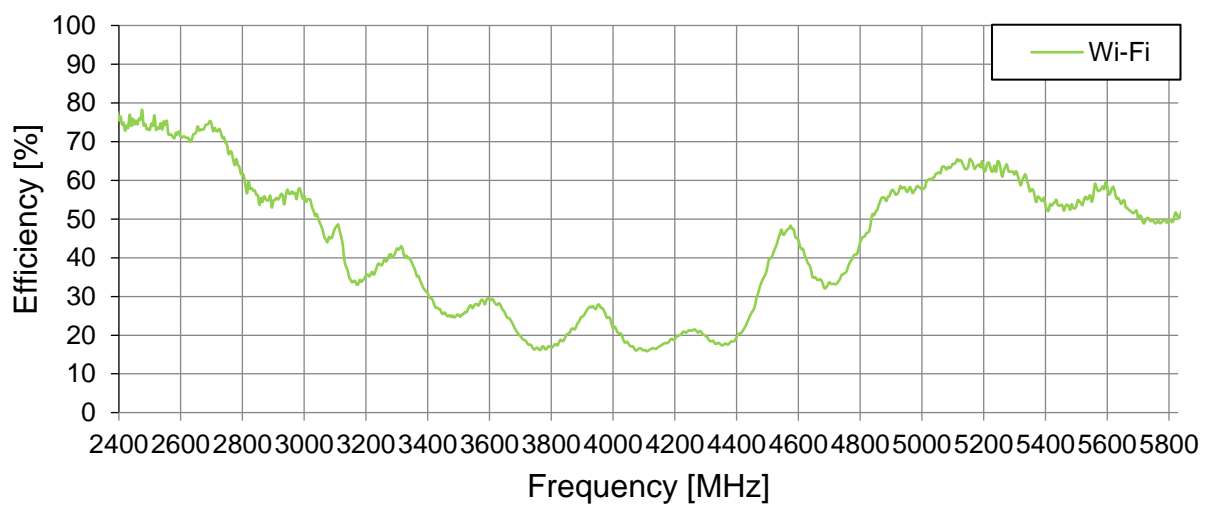

Average Gain

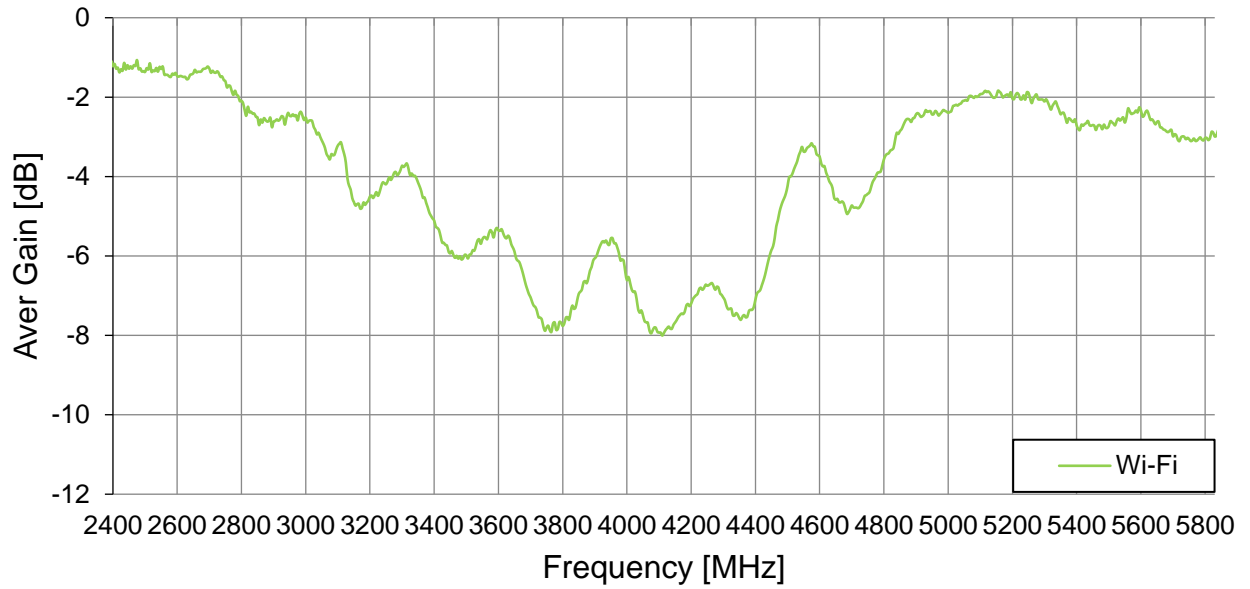

Peak Gain

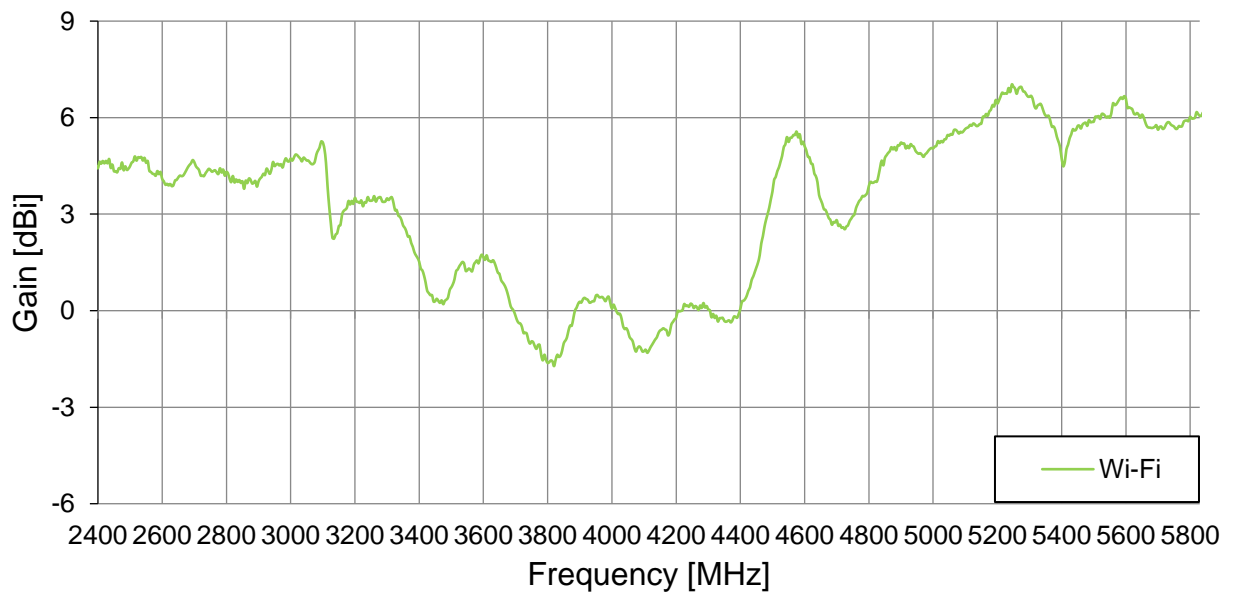

4. Radiation Patterns

4.1 Test Setup

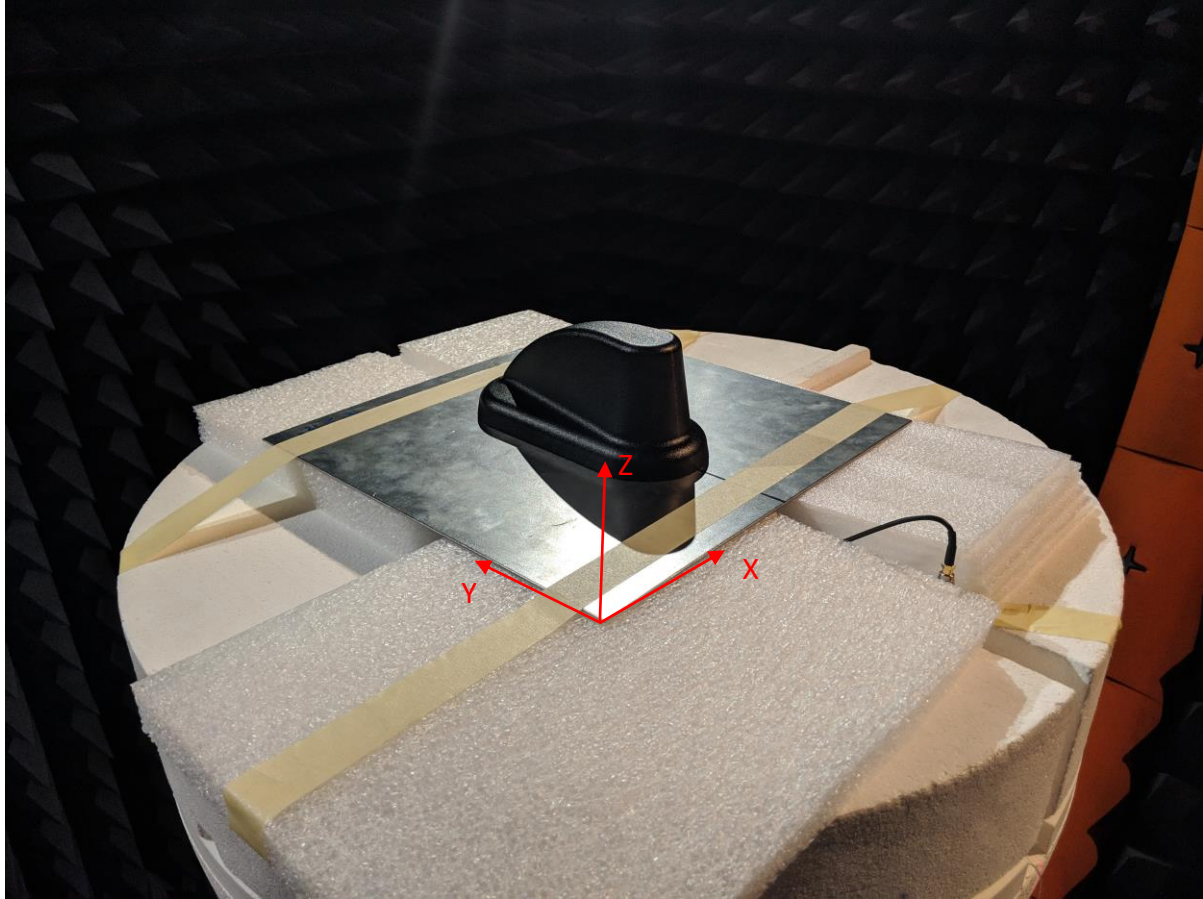

4.2 GNSS 1559MHz 3D and 2D Radiation Patterns

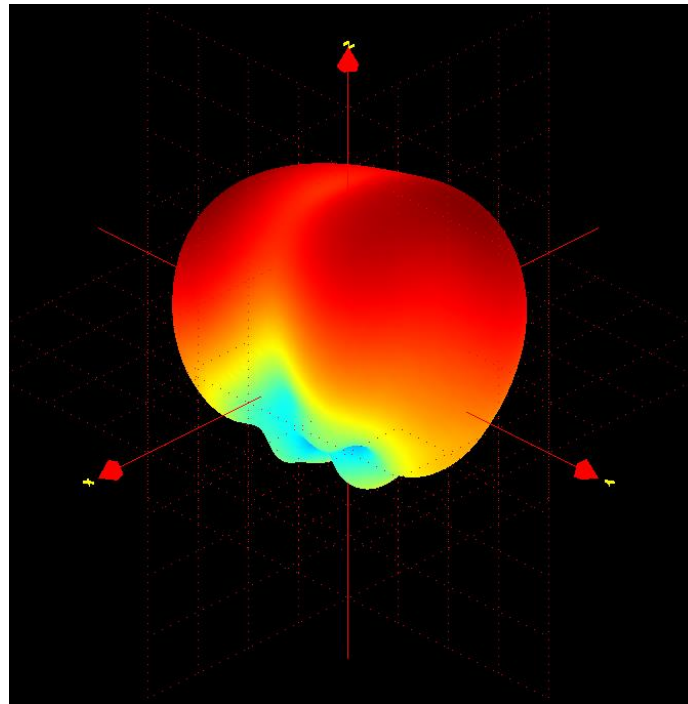

XZ Plane

YZ Plane

XY Plane

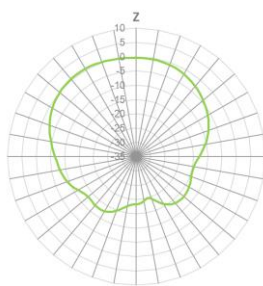

X

1559 MHz

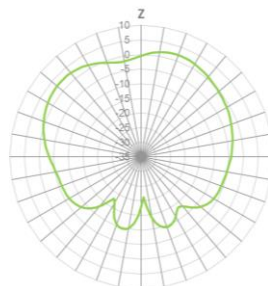

Y

1559 MHz

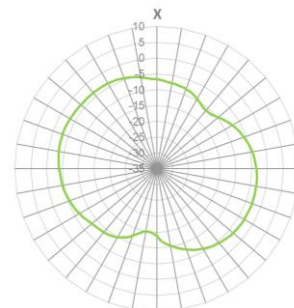

Y

1559 MHz

4.3 GNSS 1575MHz 3D and 2D Radiation Patterns

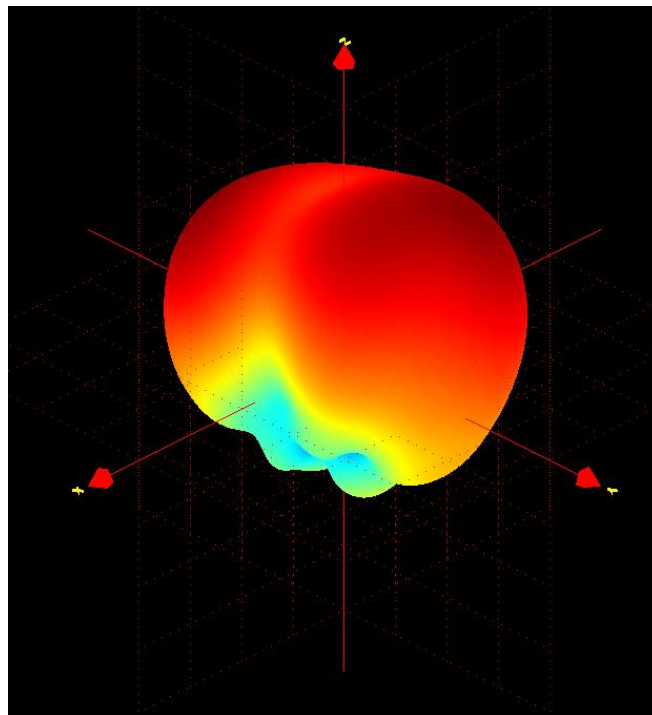

XZ Plane

YZ Plane

XY Plane

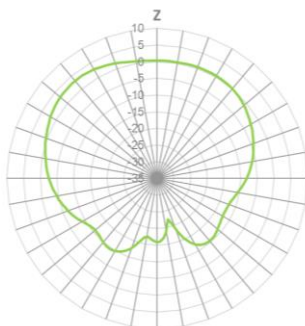

X

1575.5 MHz

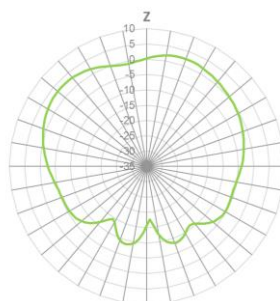

Y

1575.5 MHz

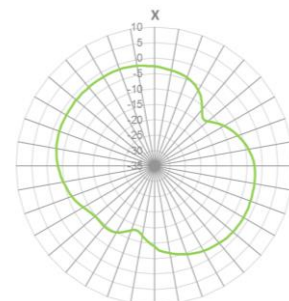

Y

1575 MHz

4.4 GNSS 1602MHz 3D and 2D Radiation Patterns

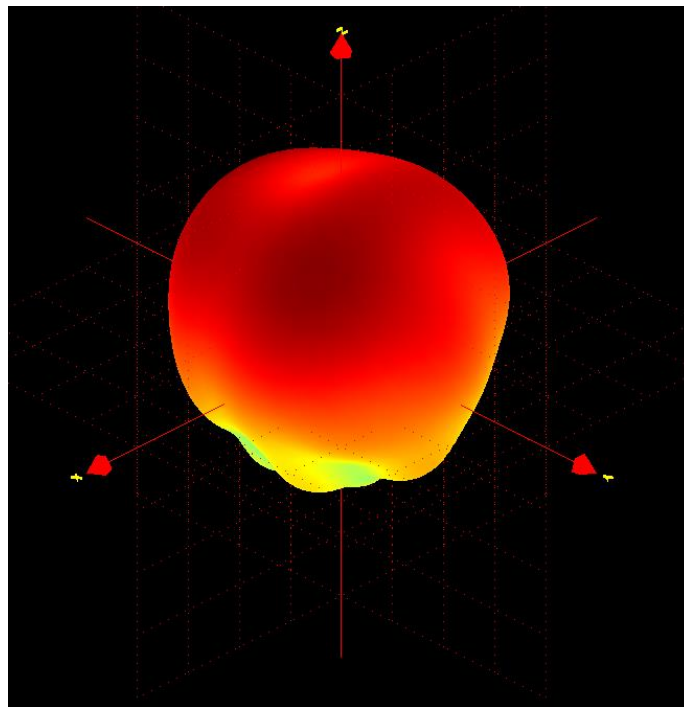

XZ Plane

YZ Plane

XY Plane

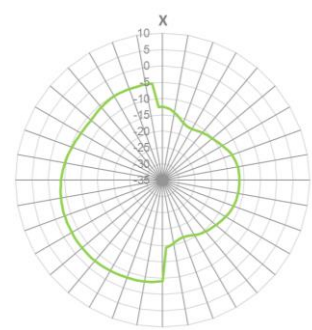
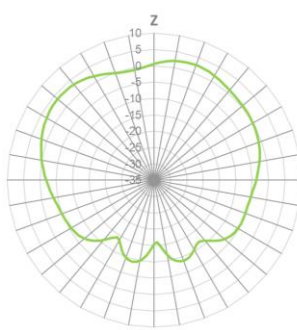
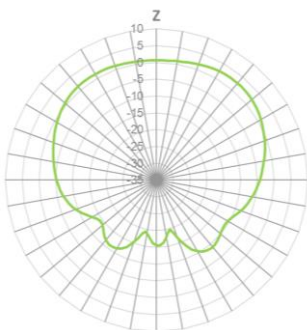

4.5 SDARS 2305MHz 3D and 2D Radiation Patterns

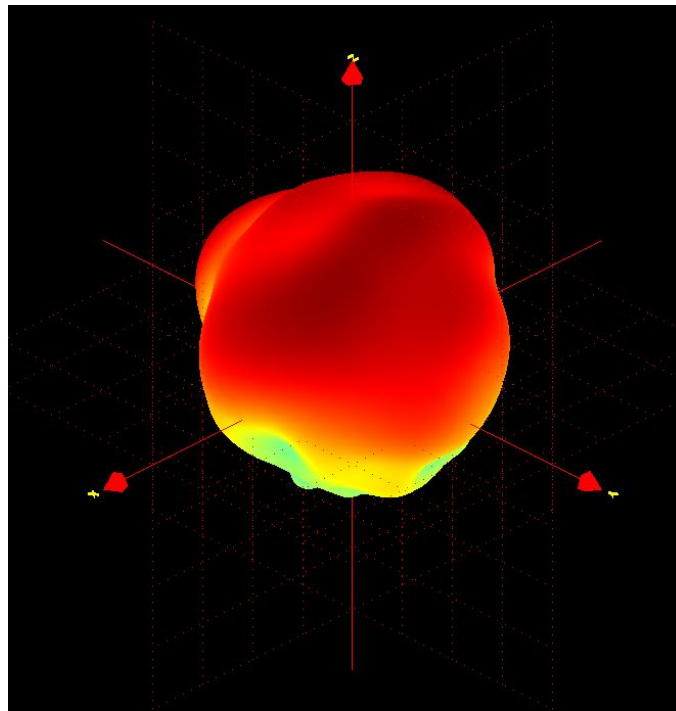

XZ Plane

YZ Plane

XY Plane

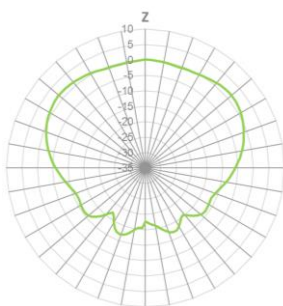

X

— 2305 MHz

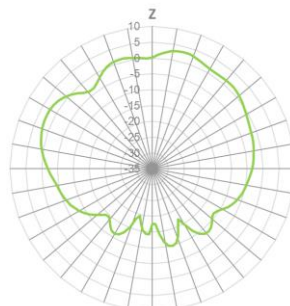

Y

— 2305 MHz

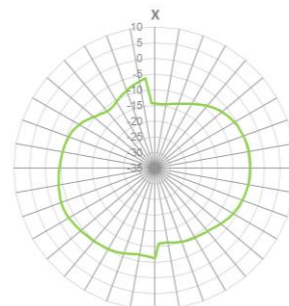

Y

— 2305 MHz

4.6 SDARS 2335MHz 3D and 2D Radiation Patterns

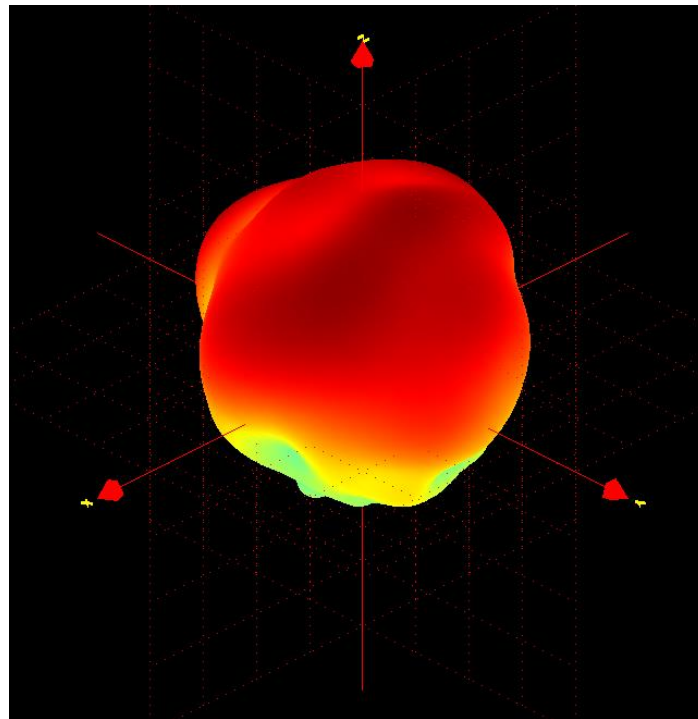

XZ Plane

YZ Plane

XY Plane

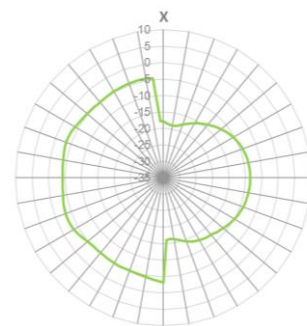
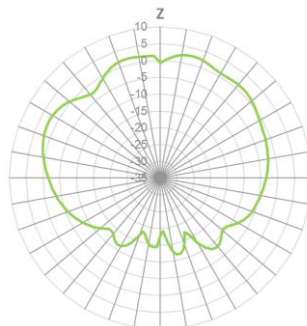
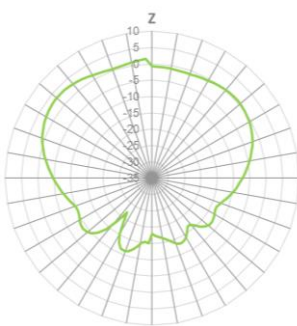

4.7 SDARS 2365MHz 3D and 2D Radiation Patterns

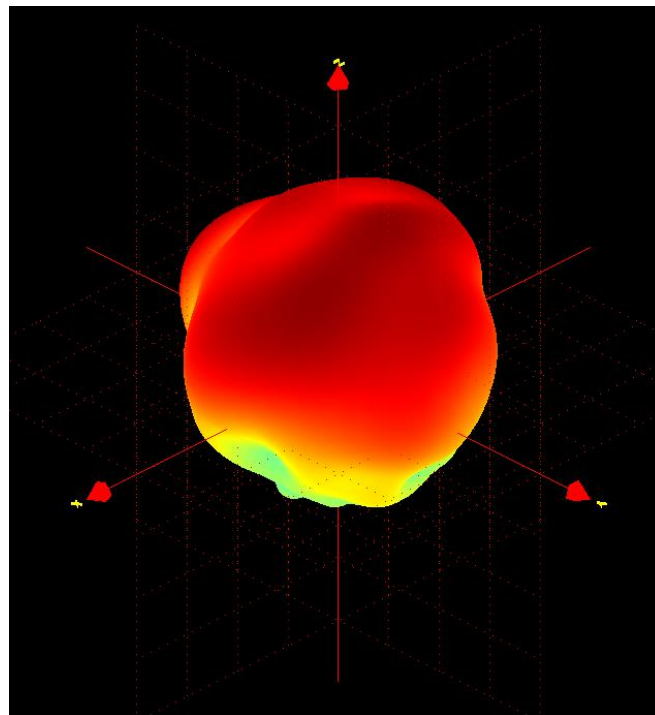

XZ Plane

YZ Plane

XY Plane

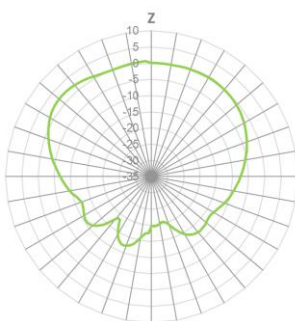

X

— 2365 MHz

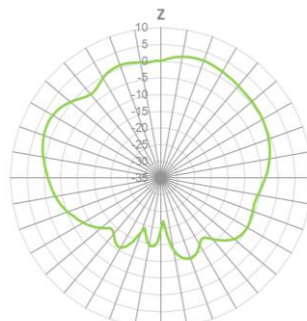

Y

— 2365 MHz

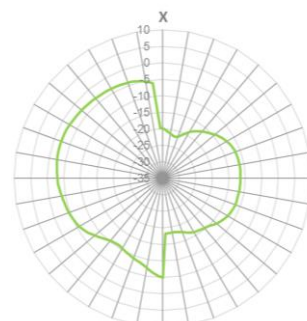

Y

— 2365 MHz

4.8 Wi-Fi 2400MHz 3D and 2D Radiation Patterns

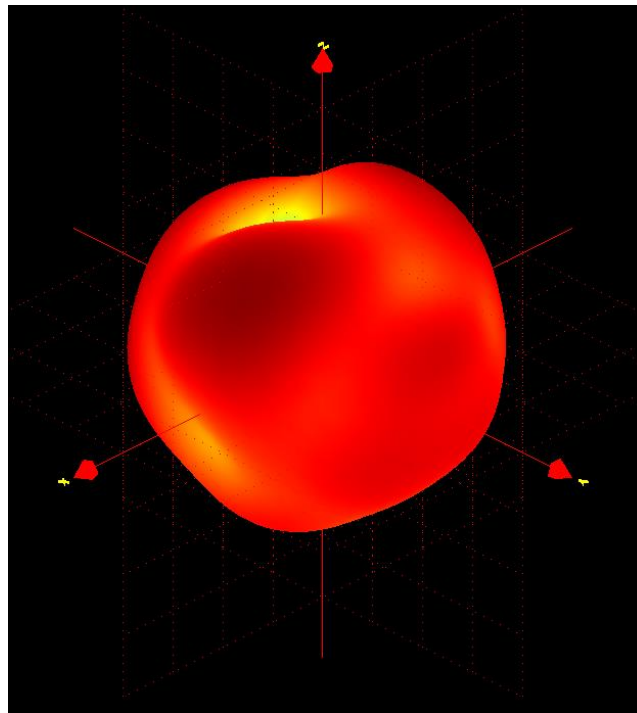

XZ Plane

YZ Plane

XY Plane

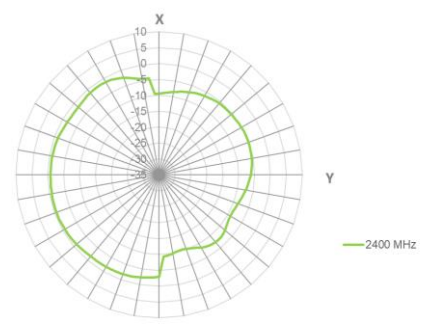
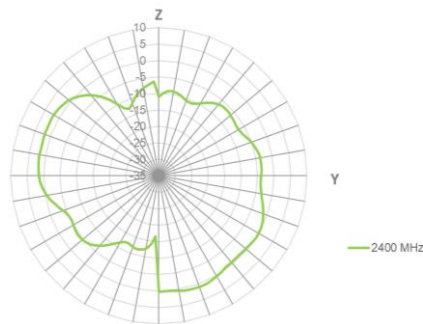
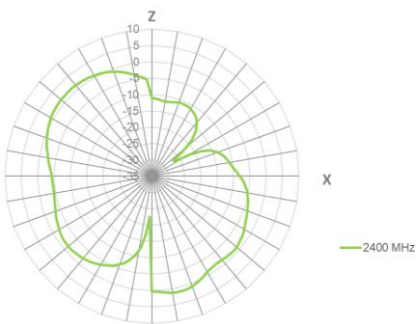

4.9 Wi-Fi 2450MHz 3D and 2D Radiation Patterns

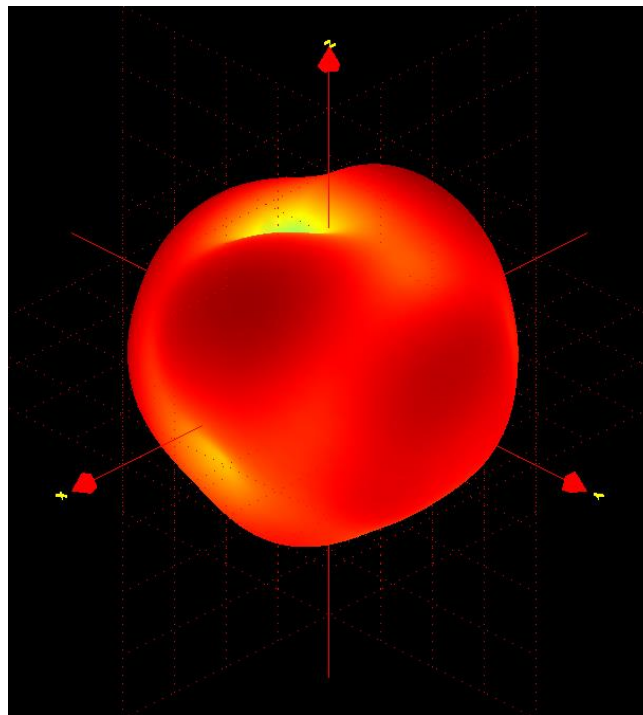

XZ Plane

YZ Plane

XY Plane

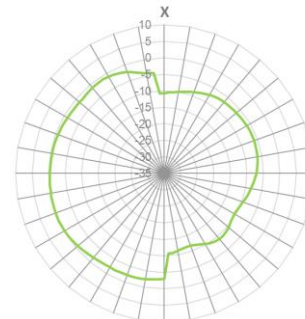
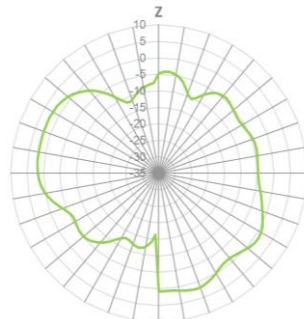
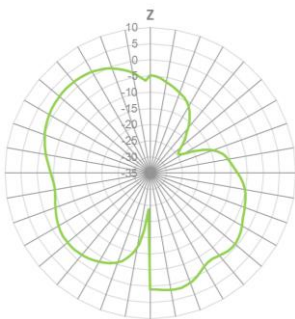

4.10 Wi-Fi 2500MHz 3D and 2D Radiation Patterns

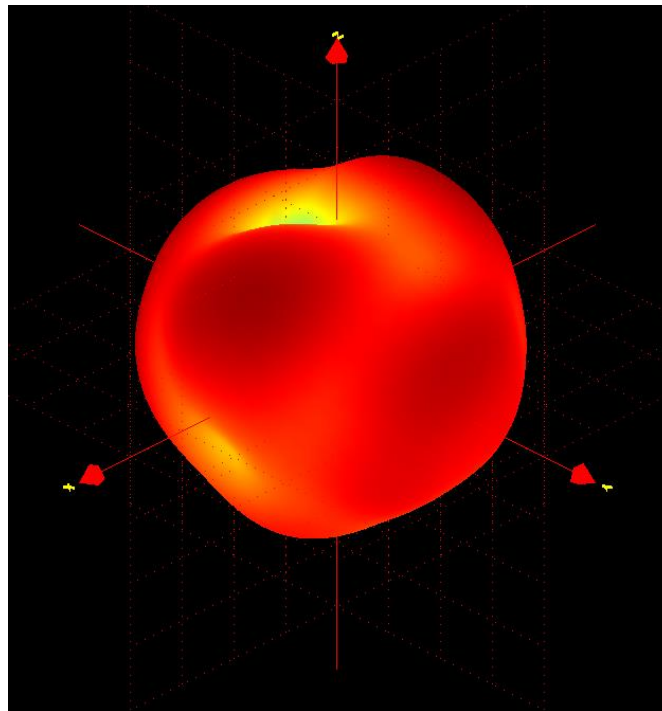

XZ Plane

YZ Plane

XY Plane

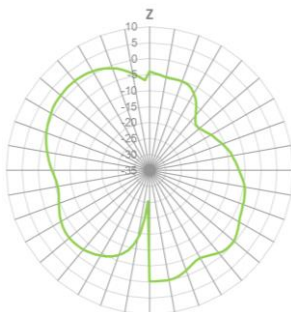

X

— 2500 MHz

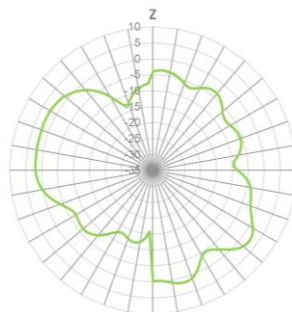

Y

— 2500 MHz

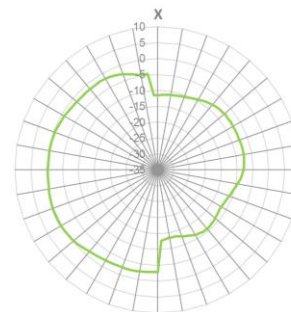

Y

— 2500 MHz

4.11 Wi-Fi 5725MHz 3D and 2D Radiation Patterns

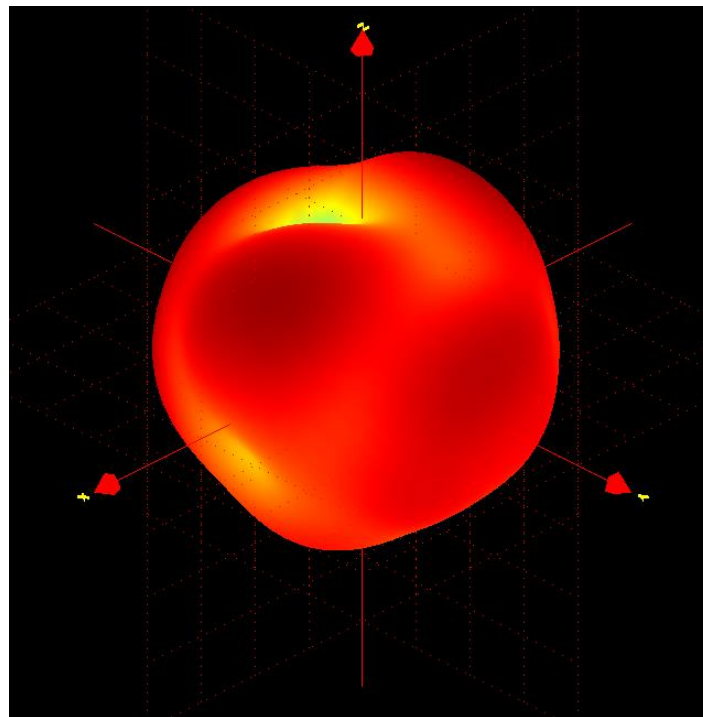

XZ Plane

YZ Plane

XY Plane

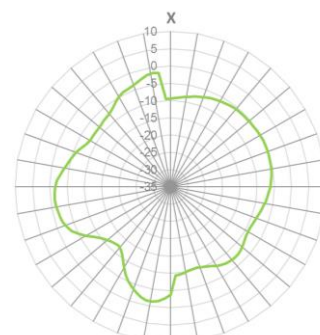
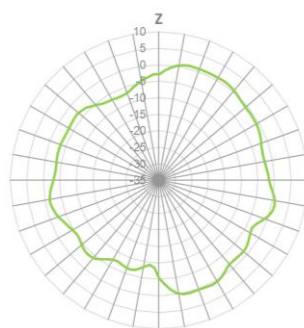
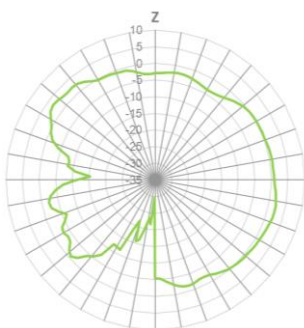

4.12 Wi-Fi 5800MHz 3D and 2D Radiation Patterns

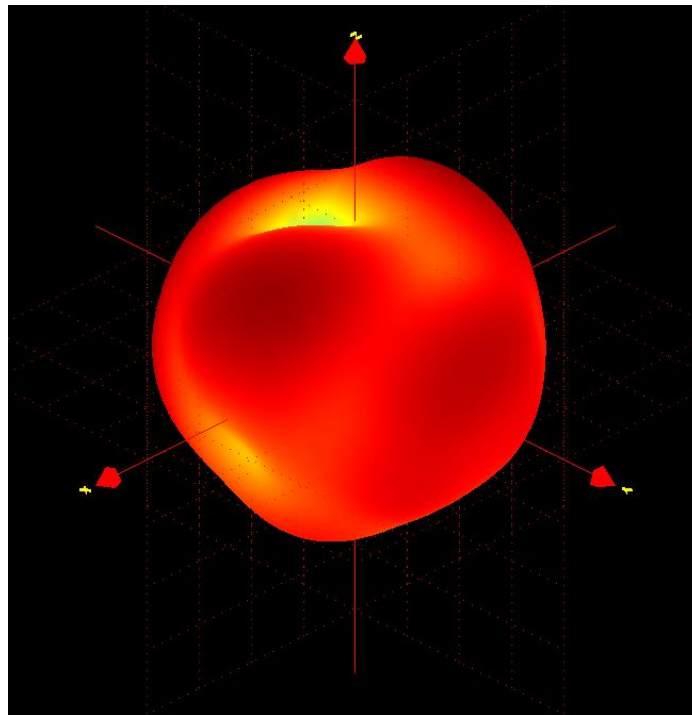

XZ Plane

YZ Plane

XY Plane

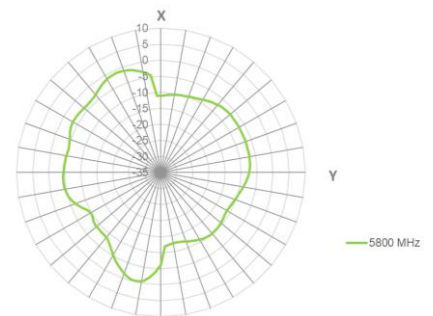
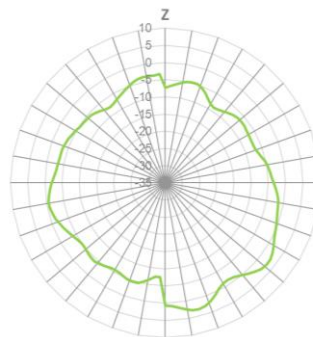
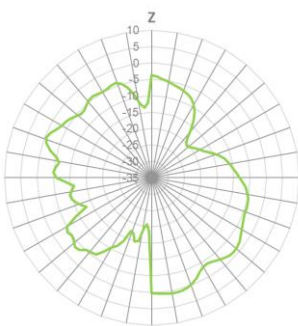

4.13 Wi-Fi 5875MHz 3D and 2D Radiation Patterns

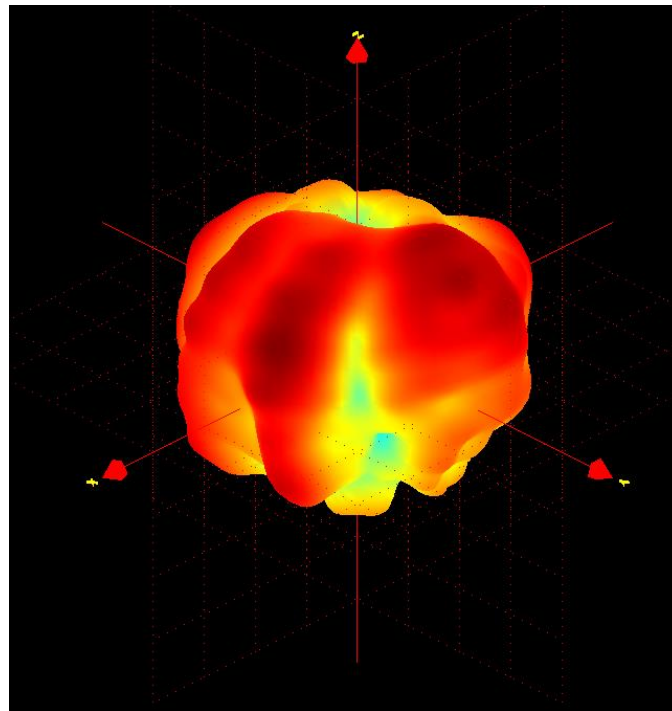

XZ Plane

YZ Plane

XY Plane

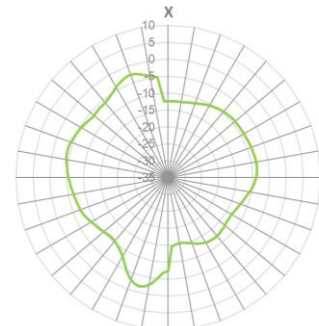
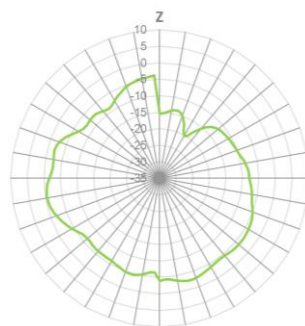
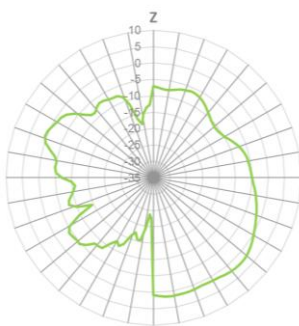

5. Mechanical Drawing (Units: mm)

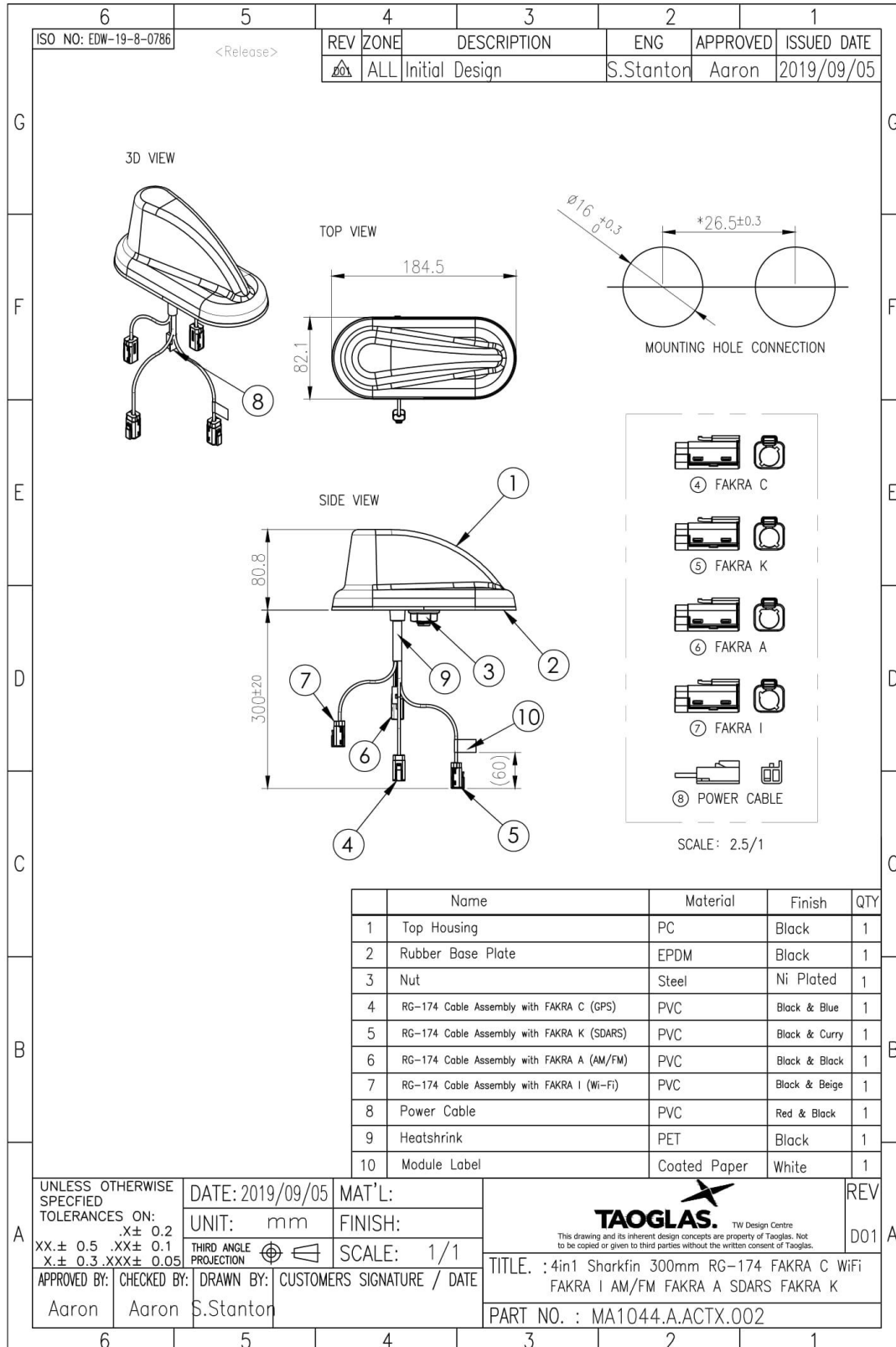

6. Packaging

1pc MA1044.A.ACTX.002 per Poly Bag
Weight: 440g

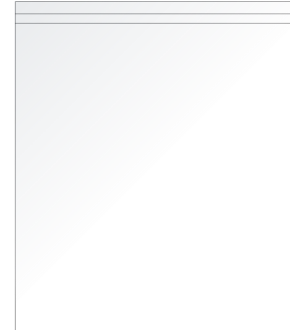

24pcs MA1044.A.ACTX.002 per Carton
Dimensions: 495*440*300mm
Weight: 13.5Kg

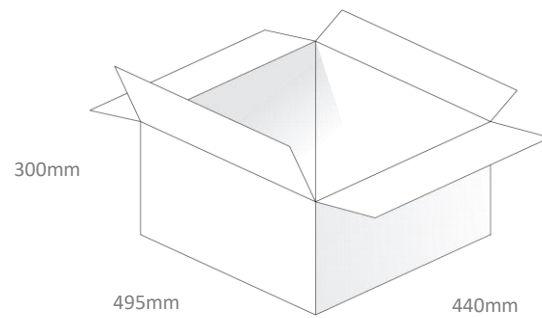

Pallet Dimensions:
1407*1000*1000mm
16 Cartons Per Pallet
4 Cartons Per Layer, 4 Layers

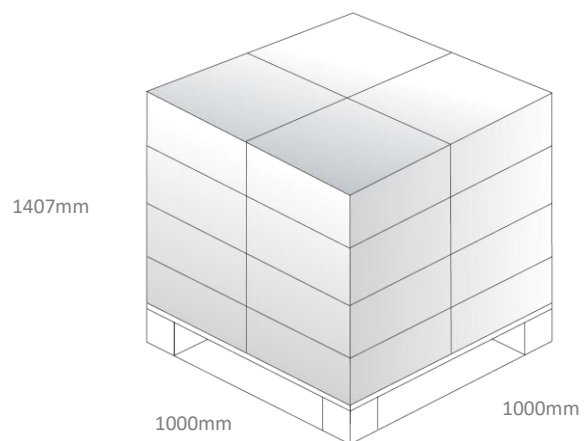

Changelog for the datasheet

SPE-19-8-118 – MA1044.A.ACTX.002

Revision: A (Original First Release)

Date:	2019-08-28
Notes:	Initial Datasheet Release
Author:	Yu Kai Yeung

Previous Revisions



TAOGLAS®

www.taoglas.com



X-ON Electronics

Largest Supplier of Electrical and Electronic Components

Click to view similar products for [Antennas](#) category:

Click to view products by [Taoglas](#) manufacturer:

Other Similar products are found below :

[GAN30084EU](#) [930-033-R](#) [GW17.07.0250E](#) [1513563-1](#) [EXE902SM](#) [APAMPG-117](#) [MAF94383](#) [W3908B0100](#) [W6102B0100](#) [YE572113-30RSMM](#) [108-00014-50](#) [66089-2406](#) [SPDA17RP918](#) [A09-F8NF-M](#) [A09-F5NF-M](#) [RGFRA1903041A1T](#) [W3593B0100](#) [W3921B0100](#) [SIMNA-868](#) [SIMNA-915](#) [SIMNA-433](#) [W1044](#) [W1049B090](#) [A75-001](#) [WTL2449CQ1-FRSMM](#) [CPL9C](#) [EXB148BN](#) [0600-00060](#) [TRA9020S3PBN-001](#) [Y4503](#) [GD5W-28P-NF](#) [MA9-7N](#) [GD53-25](#) [GD5W-21P-NF](#) [C37](#) [MAF94051](#) [MA9-5N](#) [EXD420PL](#) [B1322NR](#) [QWFTB120](#) [MAF94271](#) [MAF94300](#) [GPSMB301](#) [FG4403](#) [AO-AGSM-OM54](#) [5200232](#) [MIKROE-2349](#) [WCM.01.0111](#) [MIKROE-2393](#) [MIKROE-2352](#)