



TAOGLAS®



Datasheet

Olympian II MA145 3-in-1 Antenna

Part No:
MA145.A.LBC.001

Description:

Olympian II 3-in-1 GNSS, 5G/4G & Wi-Fi Permanent Mount Antenna

Features:

- 1*Cellular Antenna
- 1*Dual-band Wi-Fi Antenna
- 1*Active GPS/Galileo and GLONASS Antenna
- No Ground Plane Required
- IP67 Rated Enclosure
- Cables: 1m of RG-174
- Connectors: GNSS and Cellular SMA(M), Wi-Fi RP-SMA(M)
- Dimensions: 50mm Diameter x 48.5mm
- Cables and Connectors Customizable
- RoHS & REACH Compliant

1. Introduction	3
2. Specifications	4
3. Active Antenna Characteristics	7
4. Antenna Characteristics	13
5. Radiation Patterns	18
6. Mechanical Drawing	41
7. Packaging	42
8. Application Note	43
Changelog	53

Taoglas makes no warranties based on the accuracy or completeness of the contents of this document and reserves the right to make changes to specifications and product descriptions at any time without notice. Taoglas reserves all rights to this document and the information contained herein.

Reproduction, use or disclosure to third parties without express permission is strictly prohibited.



1. Introduction



The Taoglas Olympian II, MA145 is a high performance 3-in-1 combination GNSS, 5G/4G & Wi-Fi permanent mount antenna in a compact housing at only 48.5mm tall and 50mm in diameter. It is ideal for external use on vehicles and outdoor assets requiring GNSS, Cellular and Wi-Fi connectivity.

The GPS/GLONASS/Galileo antenna has stable gain and radiation patterns on all bands. The 5G/4G antenna, covers all worldwide LTE bands, includes many sub 6GHz, 5G FR1 bands and also includes fallback to 3G/2G bands where required. The Wi-Fi antenna is dual band covering both 2.4 and 5.8GHz. The MA145 antenna can be mounted on metal and plastic structures but if the lower frequency bands are required, it functions best when mounted on a metal ground-plane. The antenna does work well with short cable lengths below 1m on plastic structures, however, Taoglas recommend a minimum of 1m cable lengths for stable antenna performance. When mounted on a ground-plane, the MA145 functions well at all frequencies with cables up to 3 meters in length.

The IP67 rated enclosure is made from a durable, UV resistant ABS material that makes it resistant to vandalism. An integrated rubber O-ring under the enclosure prevents water ingress under the antenna. It is mounted from the inside of the user device enclosure and the small thread allows for installation in situations where space is minimal.

Typical applications include:

- Smart Metering and Remote Monitoring
- Digital Signage
- Transportation and Telematics

Customized cable length and connectors are available, contact your regional Taoglas Customer Support Team for further information.

Note: The MA145 can be mounted on a metal enclosure but it is not suitable for mounting on a metal enclosure where the cable will be located inside the enclosure.

2. Specifications

GNSS Frequency Band							
GPS/QZSS	L1 1575.42MHz	L2 1227.6MHz	L5 1176.45MHz	L6 1278.75MHz			
	■	□	□	□			
GLONASS	L5R 1176.45MHz	L3PT 1201.5MHz	L2PT 1246MHz	L1CR 1575.42MHz	L1PT 1602MHz		
	□	□	□	■	■		
Galileo	E5a 1176.45MHz	E5b 1201.5MHz	E4 1215MHz	E3 1256MHz	E6 1278.75MHz	E2 1561MHz	L1 1575.42MHz
	□	□	□	□	□	□	■
BeiDou	B1 1561MHz	B2 1207.14MHz	B3 1268.52MHz				
	□	□	□				
Compass	E5B(B2)/ E6(B3) 1268.56MHz	E2(B1) 1561MHz					
	□	□					
SBAS	Omnistar 1542.5MHz	WAAS/EGN OS 1575.42MHz					
	□	■					

GNSS ELECTRICAL		
Frequency (MHz)	1575.42	1602
VSWR (max.)	2.0:1	2.0:1
Passive Antenna Efficiency (%)	62	67
Passive Antenna Gain at Zenith (dBi)	-1.98	-1.67
Polarization	RHCP	
Impedance	50Ω	

LNA and Filter Electrical Properties		
Frequency (MHz)	1575.42	1602
VSWR (max.)	2.0:1	2.0:1
Gain@1.8V (Typ.)	23.7 dB	25.6 dB
Gain@3.0V (Typ.)	27.5 dB	28.1 dB
Gain@5.5V (Typ.)	30.2 dB	29.7 dB
Noise@1.8V (Typ.)	3.3 dB	4.0 dB
Noise@3.0V (Typ.)	3.3 dB	4.3 dB
Noise@5.5V (Typ.)	4.0 dB	4.9 dB
Power consumption@1.8V (Typ.)	4.5 mA	
Power consumption@3.0V (Typ.)	10 mA	
Power consumption@5.5V (Typ.)	24 mA	
Total Specification (Through Antenna, SAW Filter and LNA)		
Frequency (MHz)	1575.42	1602
Gain@3V (dBi)	27 ± 3	28 ± 3
Output Impedance	50 Ω	

5G/4G Electrical									
Band	Frequency (MHz)	Ground Plane	Efficiency (%)	Average Gain (dB)	Peak Gain (dBi)	Impedance	Max Power Input	Polarization	Radiation Pattern
5G/4G Band 71	617~698	Free space	29.4	-5.5	-0.2	50Ω	10W	Linear	Directional
		30x30cm	14	-8.6	-0.7				
4G/3G Band 12,13,14,17,28,29	698~806	Free space	26.5	-5.8	-0.5				
		30x30cm	38.3	-4.2	1.3				
4G/3G Band 5,8,18,19,20,26,27	824~960	Free space	20.3	-6.9	0				
		30x30cm	30.9	-5.1	0.4				
5G/4G Band 21,32,74,75,76	1427~1518	Free space	52.8	-2.8	3.6				
		30x30cm	51.8	-2.9	2.2				
4G/3G Band 1,2,3,4,9,23,25,35,39,66	1710~2200	Free space	40.8	-4	3.8				
		30x30cm	58.2	-2.3	2.6				
4G/3G Band 7,38,41	2490~2690	Free space	43.2	-3.6	2.7				
		30x30cm	40.4	-3.9	1.8				
5G NR Band 22,42,48,77,78,79	3300~4200	Free space	36.9	-4.3	3.1				
		30x30cm	25	-6	2.7				

Wi-Fi Electrical									
Band	Frequency (MHz)	Ground Plane	Efficiency (%)	Average Gain (dB)	Peak Gain (dBi)	Impedance	Max Power Input	Polarization	Radiation Pattern
2.4GHz Wi-Fi	2400~2500	Free space	44.4	-3.5	0.7	50Ω	10W	Linear	Directional
		30x30cm	50.5	-3	3.5				
5.8GHz Wi-Fi	5150~5850	Free space	34.9	-4.6	2.7				
		30x30cm	34.5	-4.6	3.6				

Mechanical	
Height	48.5 mm
Planner Dimension	Ø50.15mm
Enclosure	UV Resistant ABS
Cable	1m RG-174 as standard
Connector	SMA(M) for GNSS and LTE / RP-SMA(M) for Wi-Fi
Base and Thread	Brass (Nickel Plated)
Thread Diameter	M12
Sealant	Rubber
Weight	100g
Environmental	
Protection	IP67
Temperature Range	-40°C to 85°C
Humidity	Non-condensing 65°C 95% RH
Thermal Shock	200 cycles -40°C to +90°C
Shock (Drop Test)	1m drop on concrete 6 axes
Cable Pull	8kgf

5G/4G Bands			
Band Number	5G NR / FR1 / LTE / LTE-Advanced / WCDMA / HSPA / HSPA+ / TD-SCDMA		
	Uplink	Downlink	Covered
1	UL: 1920 to 1980	DL: 2110 to 2170	✓
2	UL: 1850 to 1910	DL: 1930 to 1990	✓
3	UL: 1710 to 1785	DL: 1805 to 1880	✓
4	UL: 1710 to 1755	DL: 2110 to 2155	✓
5	UL: 824 to 849	DL: 869 to 894	✓
7	UL: 2500 to 2570	DL: 2620 to 2690	✓
8	UL: 880 to 915	DL: 925 to 960	✓
9	UL: 1749.9 to 1784.9	DL: 1844.9 to 1879.9	✓
11	UL: 1427.9 to 1447.9	DL: 1475.9 to 1495.9	✓
12	UL: 699 to 716	DL: 729 to 746	✓
13	UL: 777 to 787	DL: 746 to 756	✓
14	UL: 788 to 798	DL: 758 to 768	✓
17	UL: 704 to 716	DL: 734 to 746	✓
18	UL: 815 to 830	DL: 860 to 875	✓
19	UL: 830 to 845	DL: 875 to 890	✓
20	UL: 832 to 862	DL: 791 to 821	✓
21	UL: 1447.9 to 1462.9	DL: 1495.9 to 1510.9	✓
22	UL: 3410 to 3490	DL: 3510 to 3590	✓
23	UL: 2000 to 2020	DL: 2180 to 2200	✓
24	UL: 1625.5 to 1660.5	DL: 1525 to 1559	✗
25	UL: 1850 to 1915	DL: 1930 to 1995	✓
26	UL: 814 to 849	DL: 859 to 894	✓
27	UL: 807 to 824	DL: 852 to 869	✓
28	UL: 703 to 748	DL: 758 to 803	✓
29	UL: -	DL: 717 to 728	✓
30	UL: 2305 to 2315	DL: 2350 to 2360	✓
31	UL: 452.5 to 457.5	DL: 462.5 to 467.5	✗
32	UL: -	DL: 1452 - 1496	✓
35		1850 to 1910	✓
38		2570 to 2620	✓
39		1880 to 1920	✓
40		2300 to 2400	✓
41		2496 to 2690	✓
42		3400 to 3600	✓
43		3600 to 3800	✓
48		3550 to 3700	✓
66	UL: 1710-1780	DL: 2110-2200	✓
71		617 to 698	✓
74/75/76		1427 to 1518	✓
78		3300 to 3800	✓
79		4400 to 5000	✗

3. Active Antenna Characteristics

3.1 Block Diagram (Active antenna)

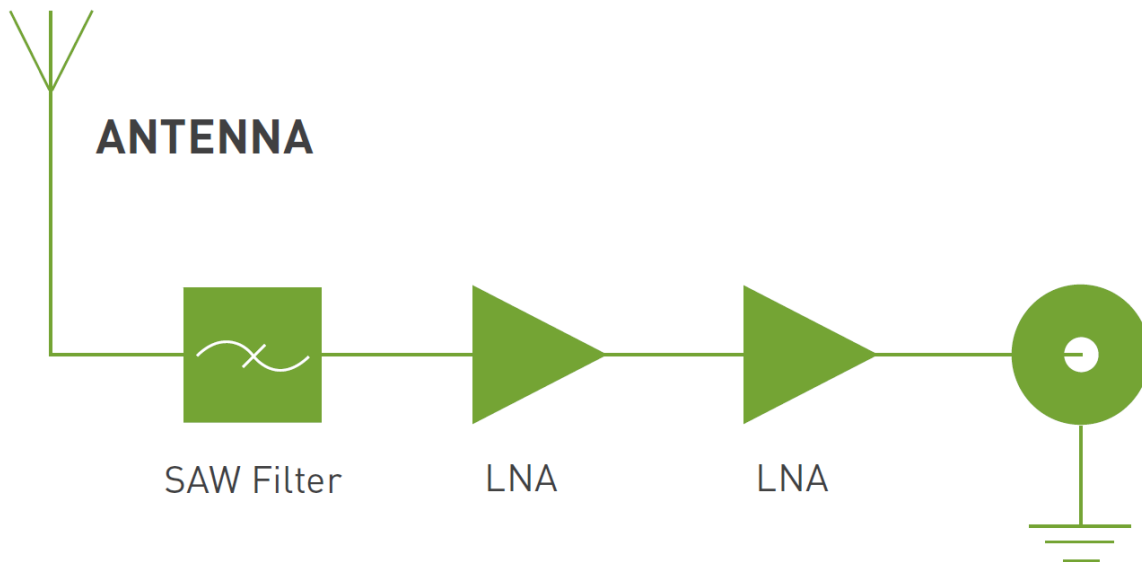

3.2 Return Loss

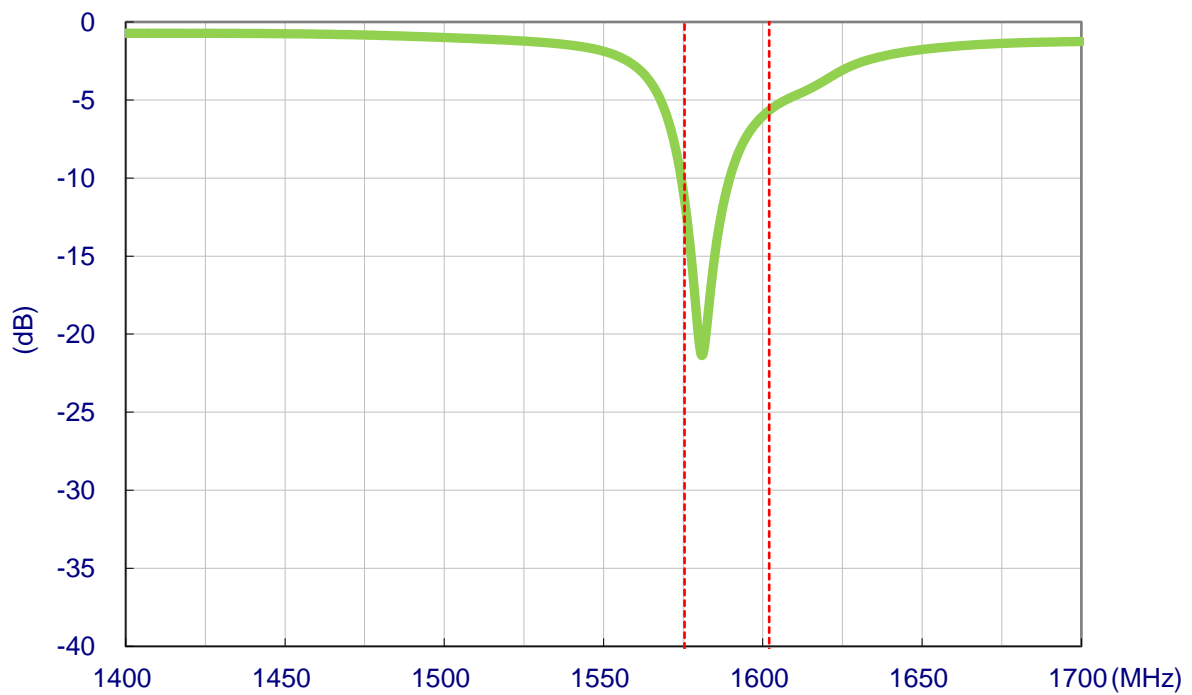

3.3 Efficiency

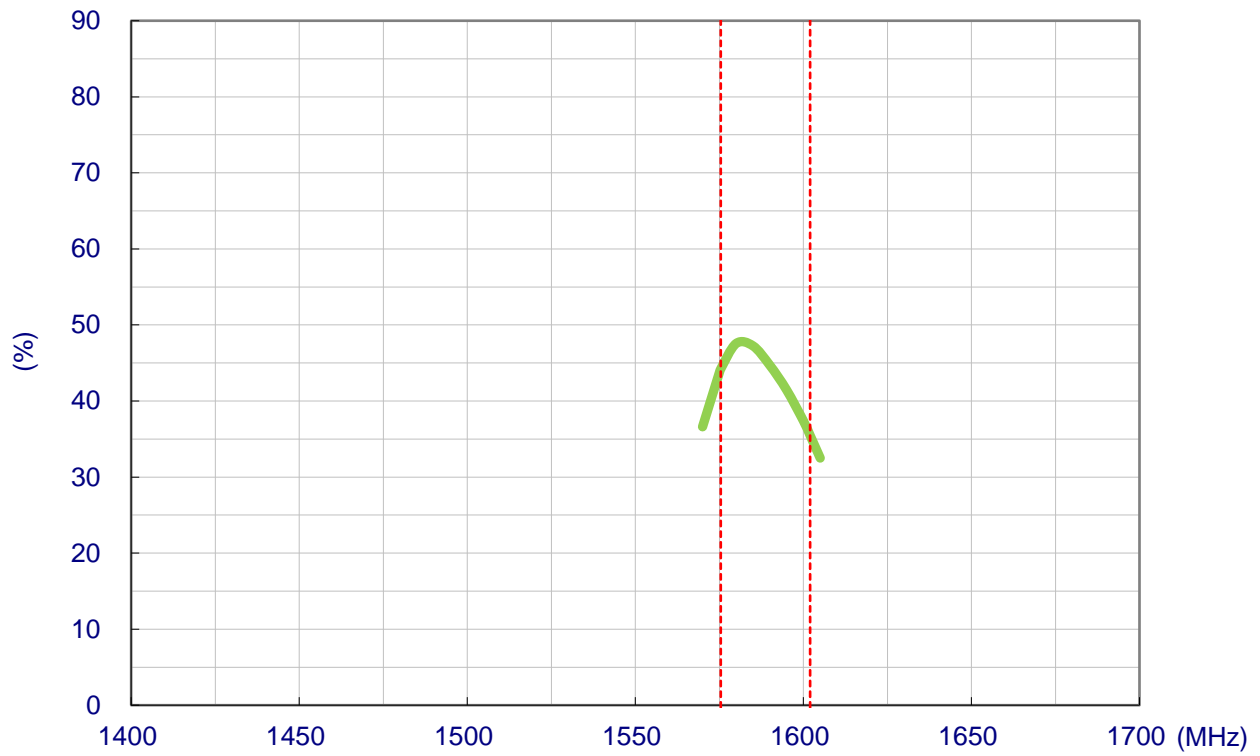

3.4 Average Gain



3.5 Peak Gain

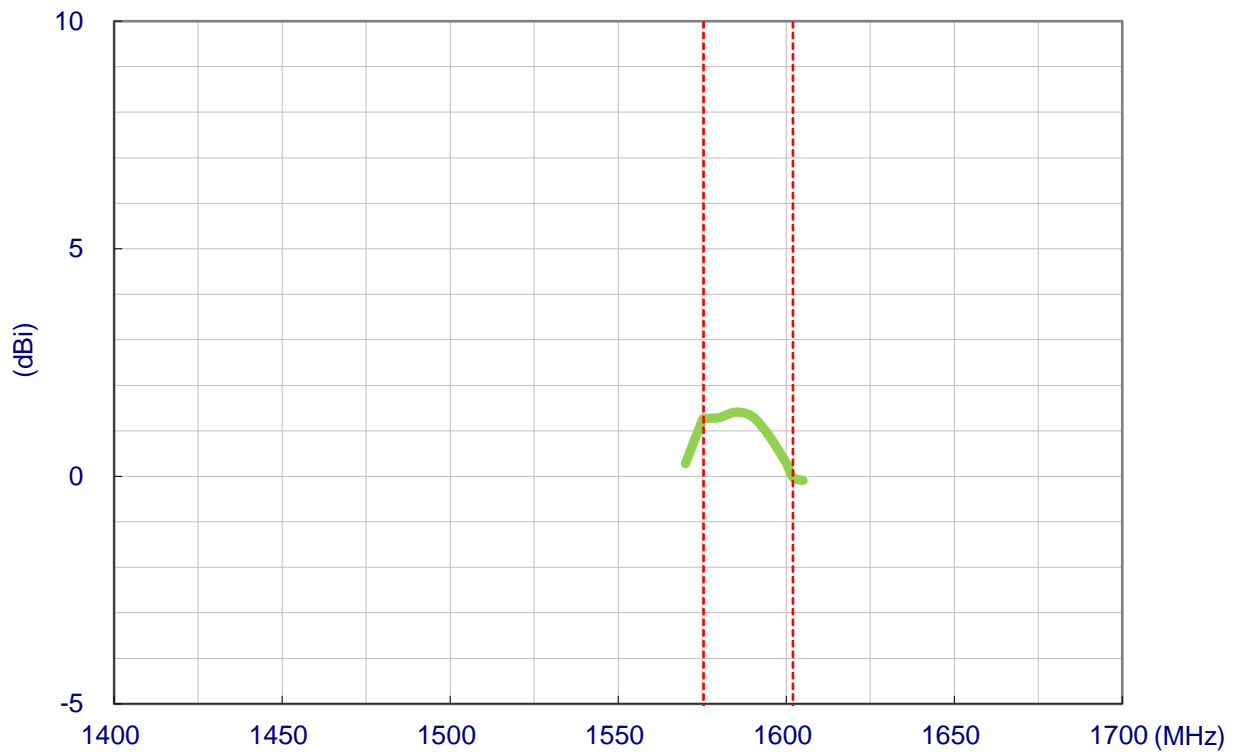

3.6 Active measurements

LNA Gain

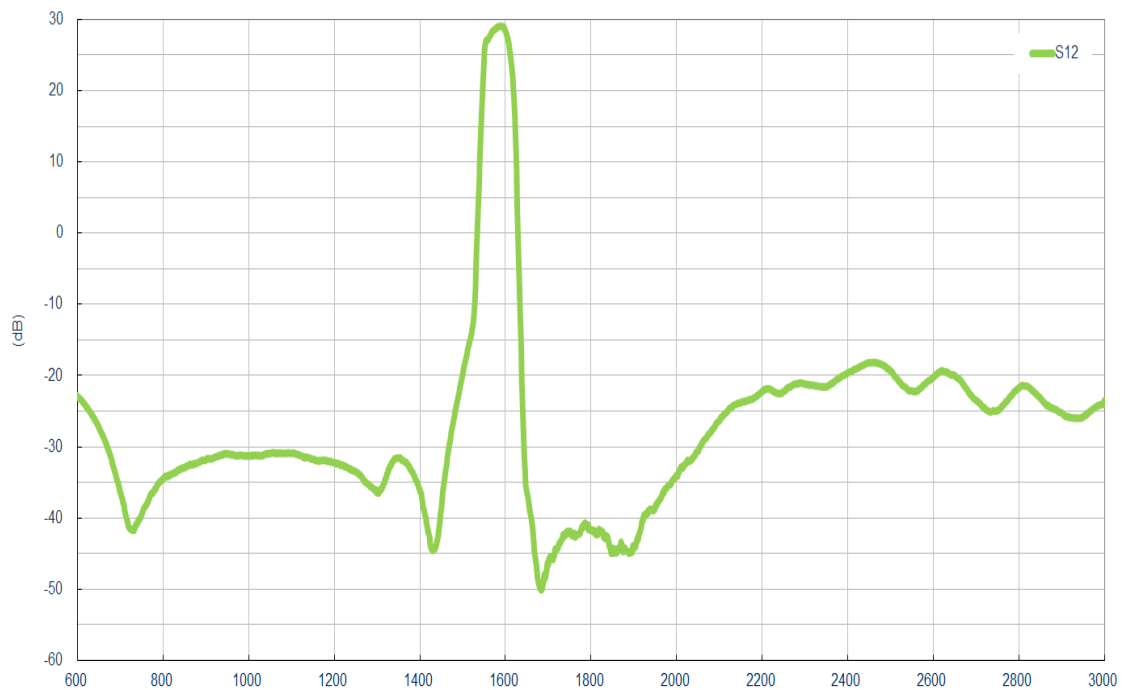

Noise Figure @ 3.0V

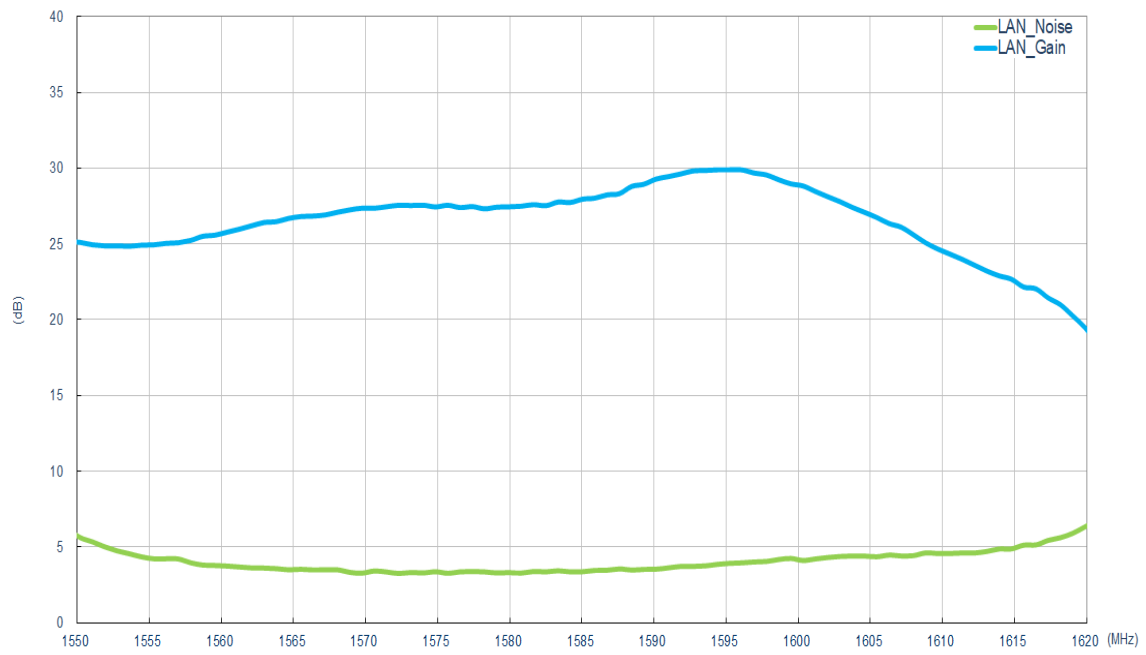

3.7 Radiation Patterns

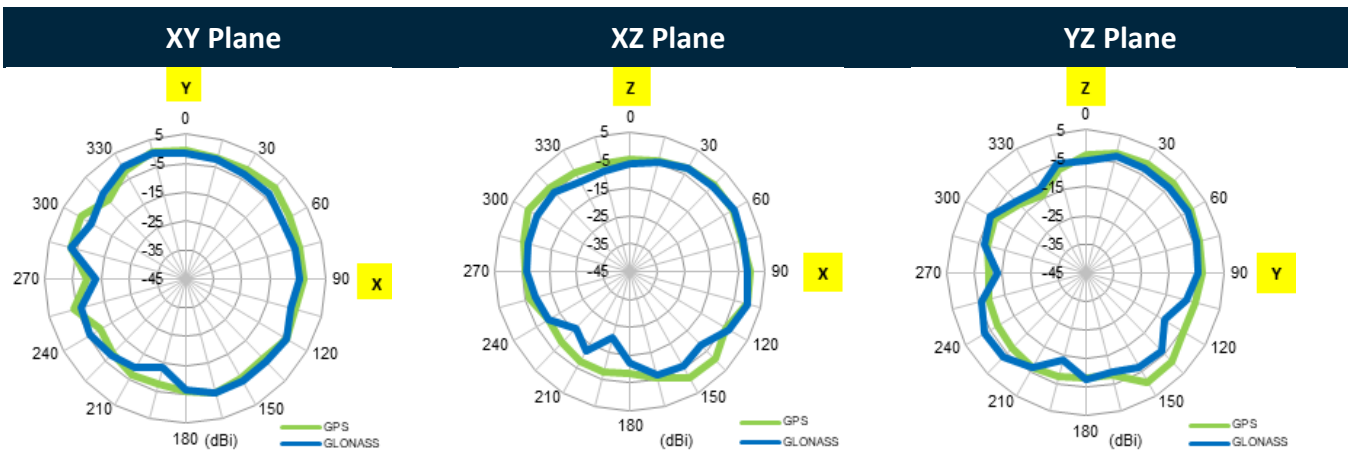
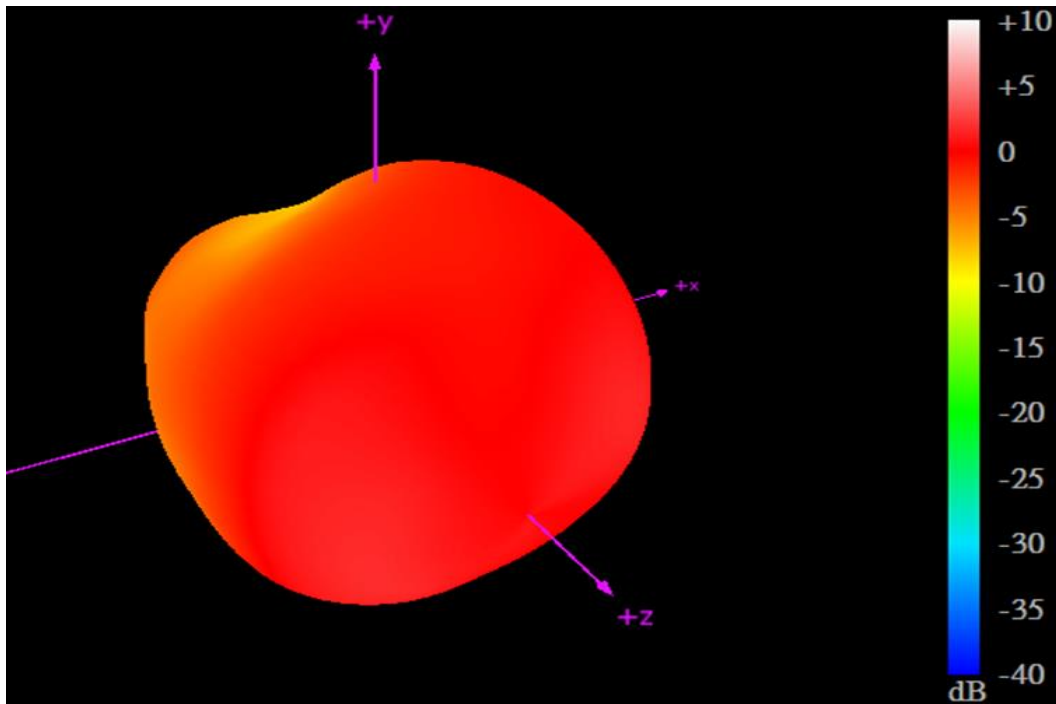

4. Antenna Characteristics

4.1 Test Setup

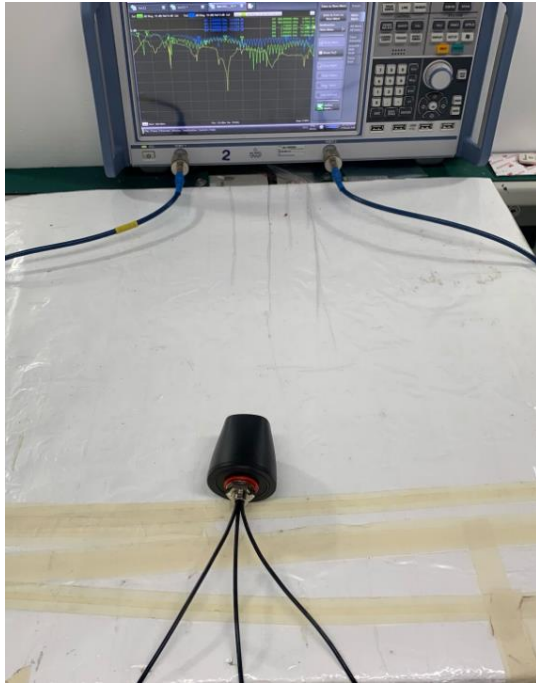

Free space

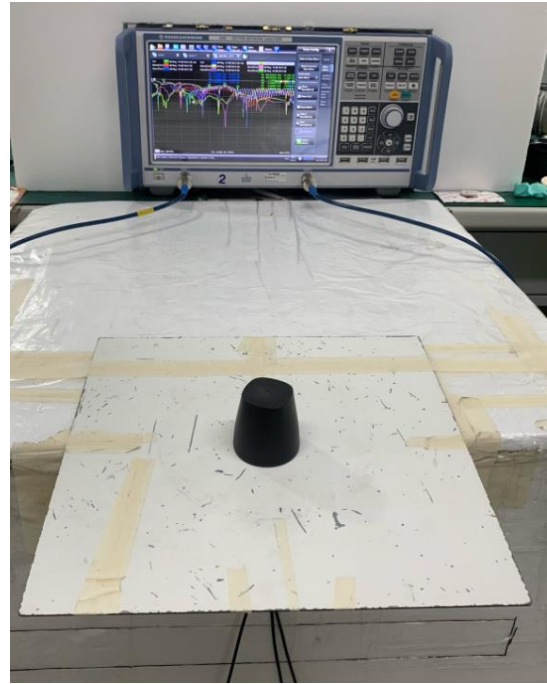

on 30x30 Ground Plane

4.2 Return Loss

LTE

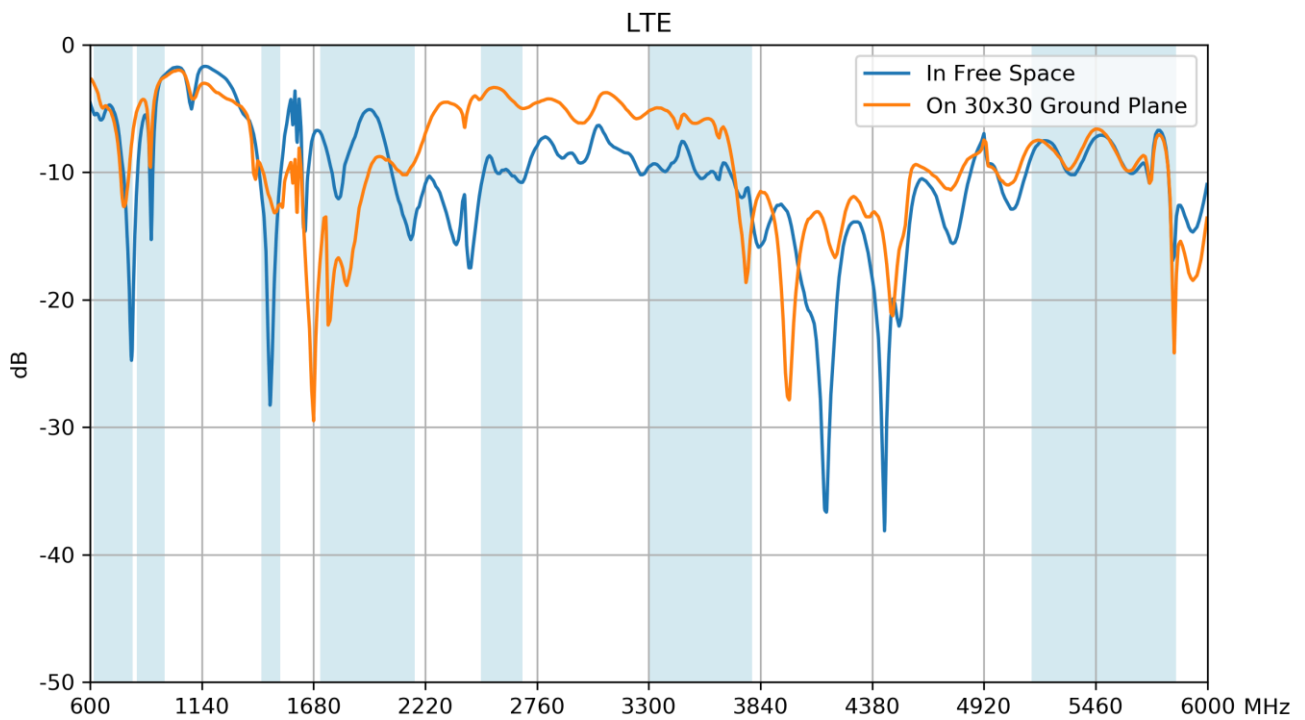

4.3 Efficiency

LTE

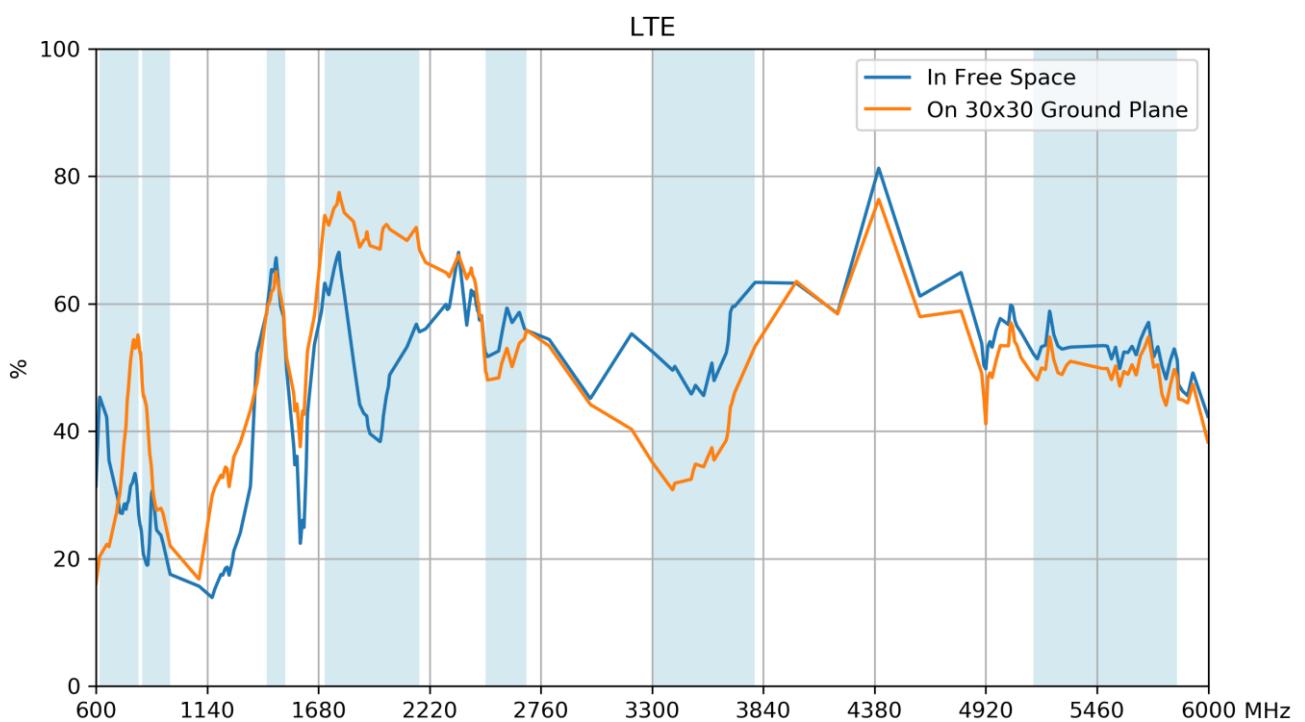

4.4 Average gain

LTE

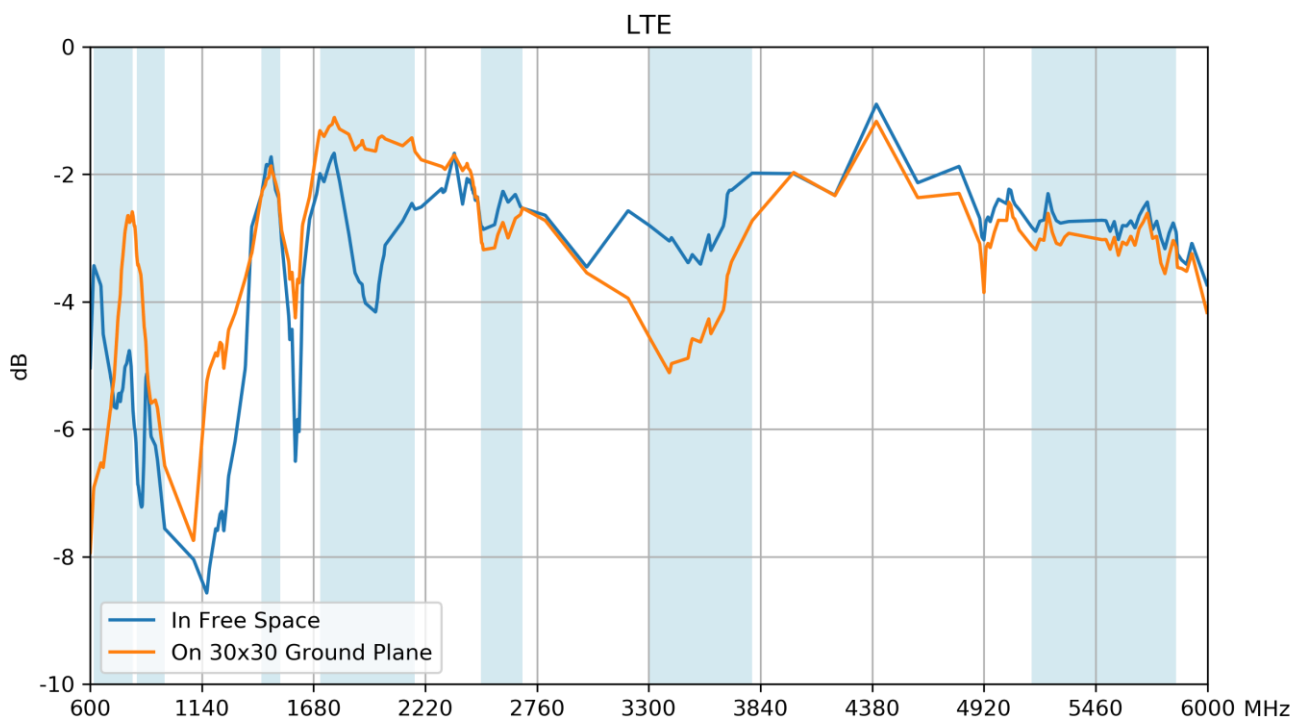

4.5 Peak gain

LTE

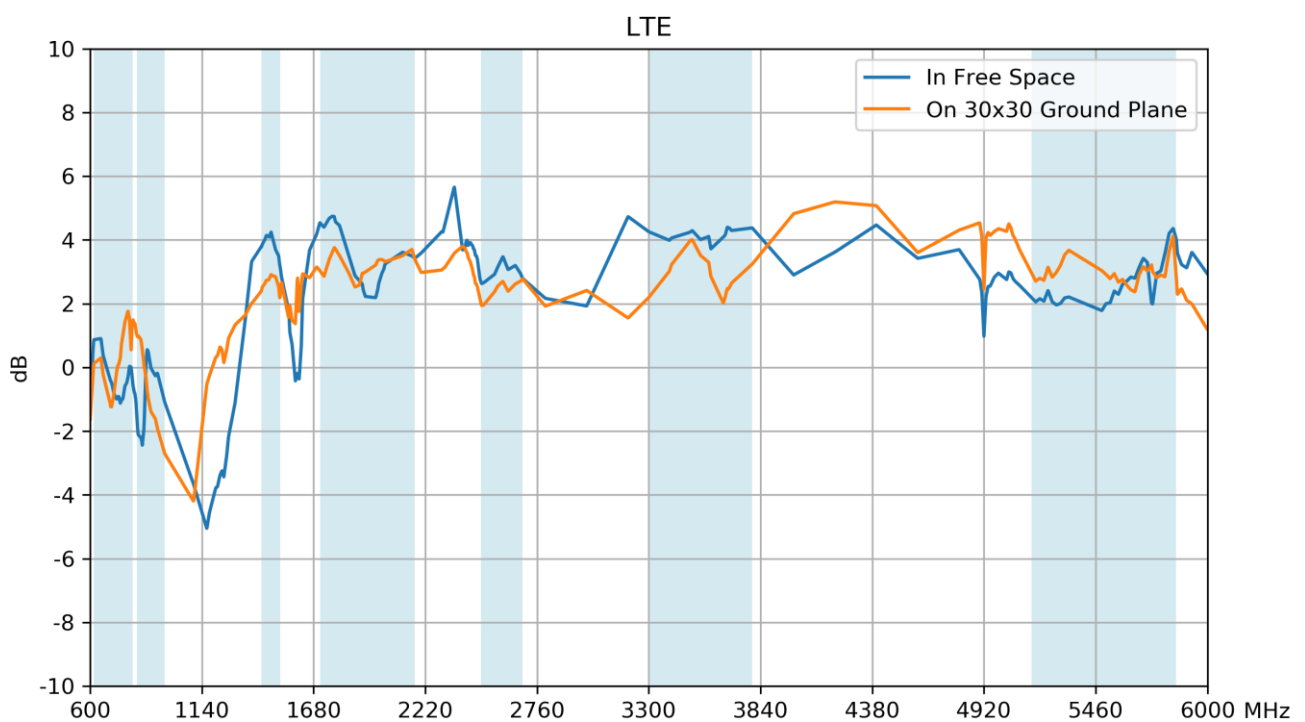

4.6 Return Loss

Wi-Fi

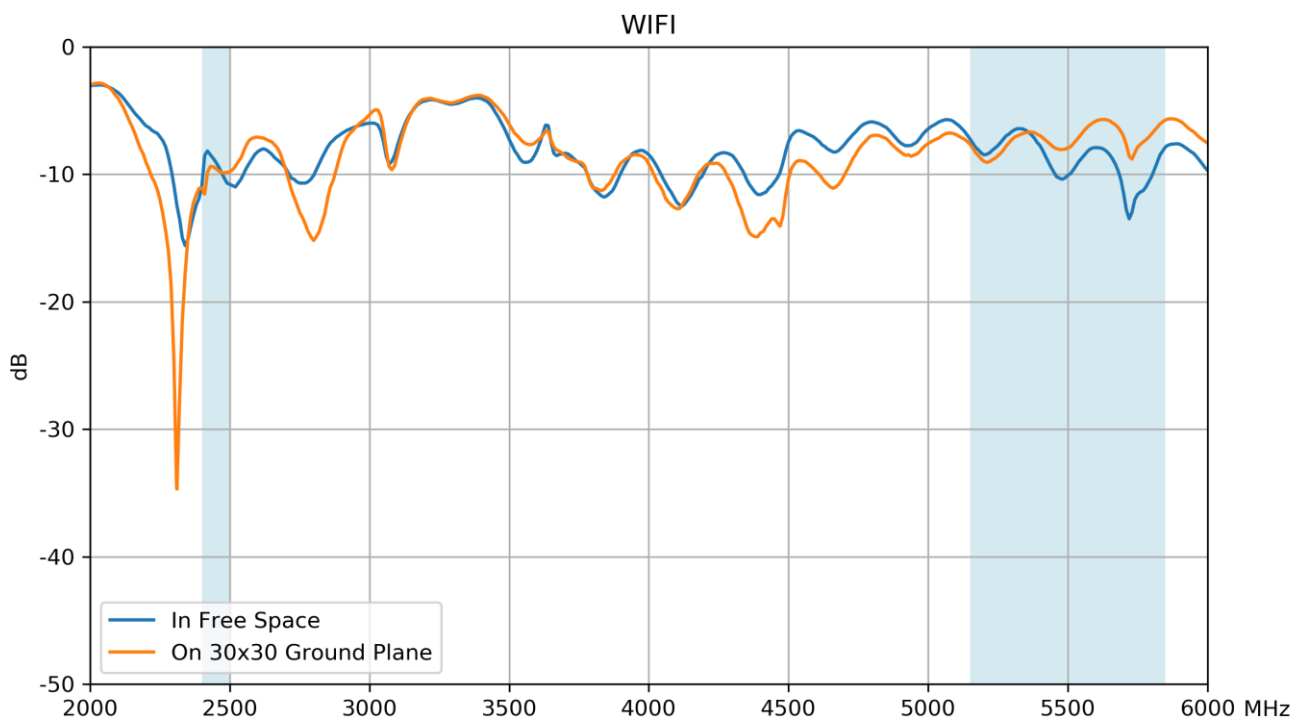

4.7 Efficiency

Wi-Fi



4.8 Average gain

Wi-Fi

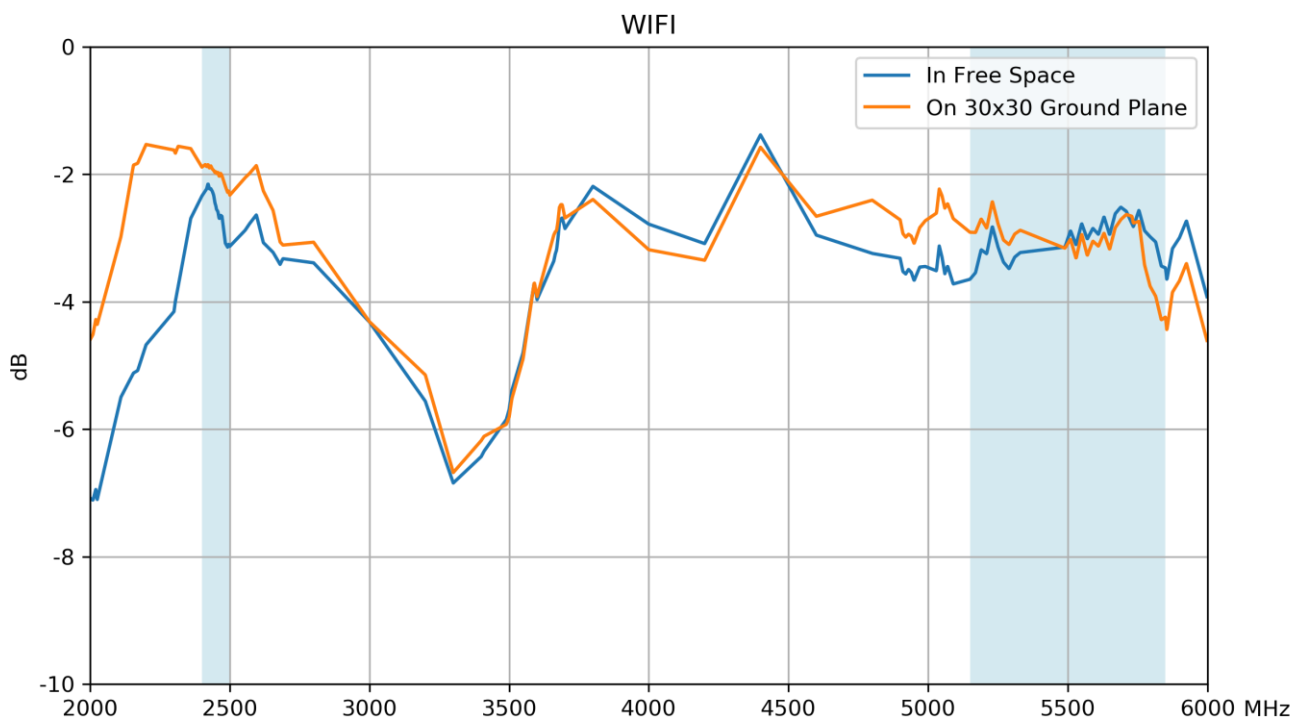

4.9 Peak Gain

Wi-Fi

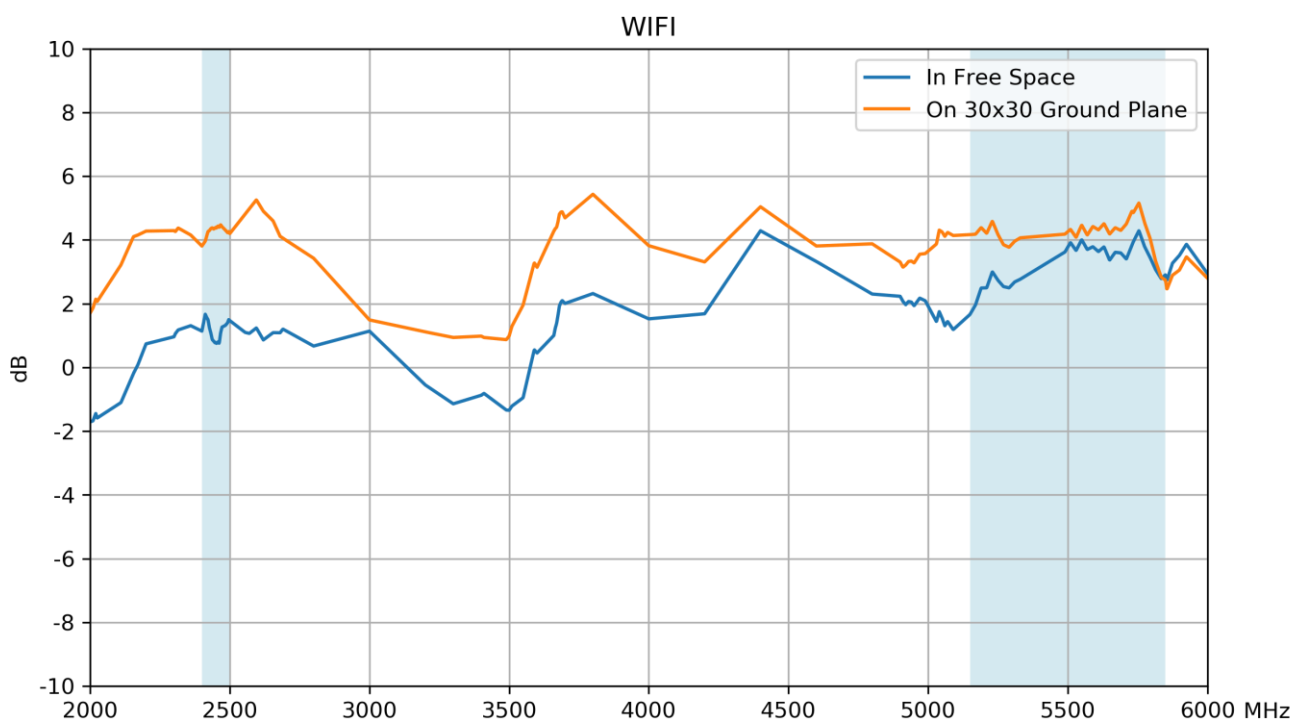

5. Radiation Patterns

5.1 Test Setup – on 30x30cm Ground Plane

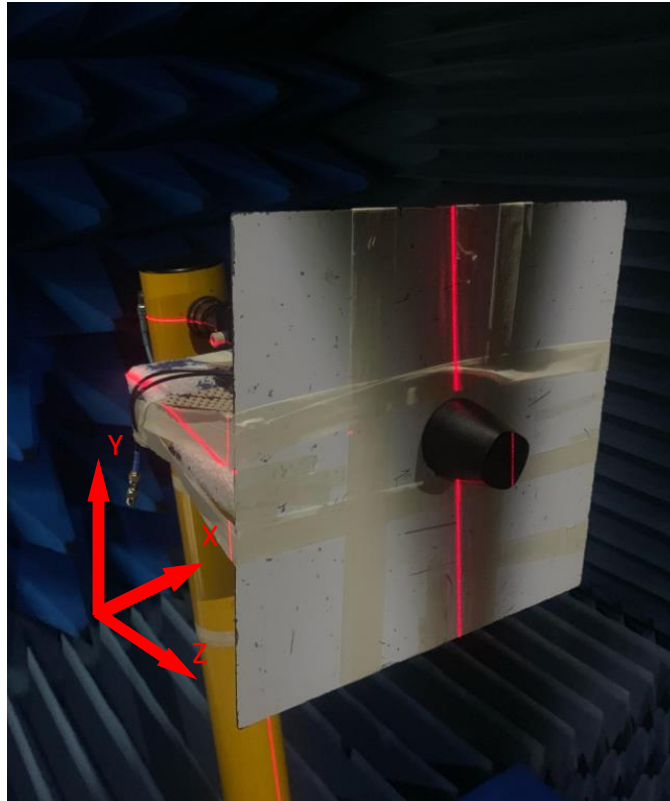

5.2 Radiation Patterns – 5G/4G Free Space

652MHz

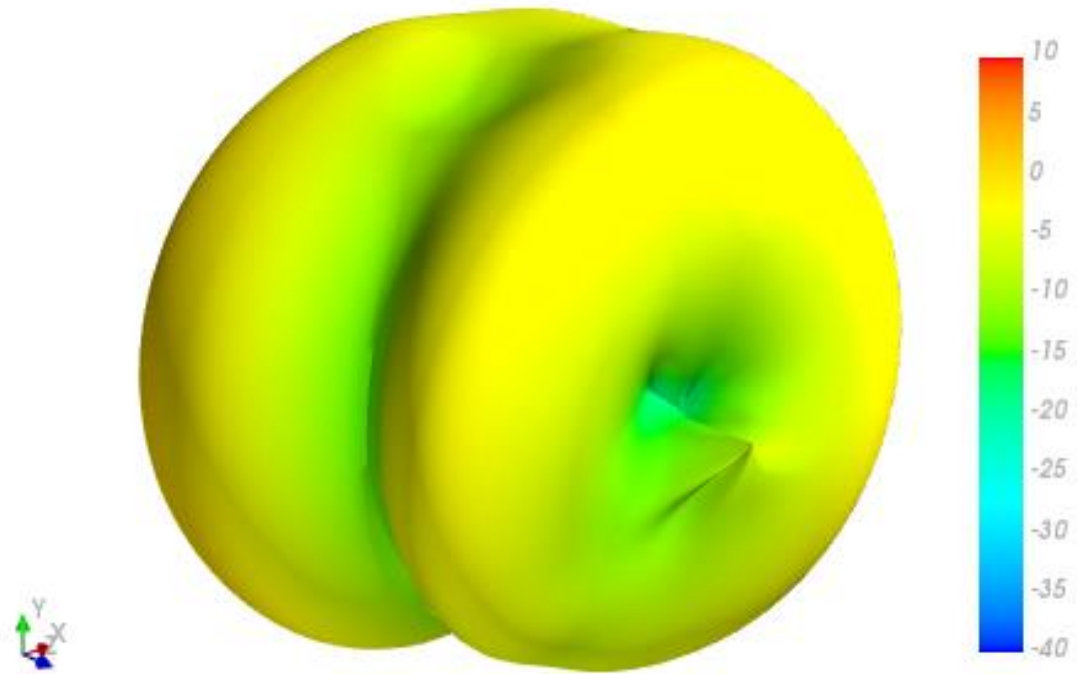

XY Plane XZ Plane YZ Plane

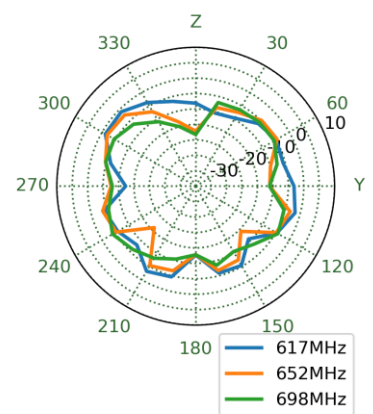
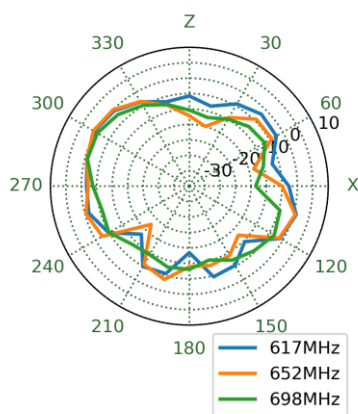
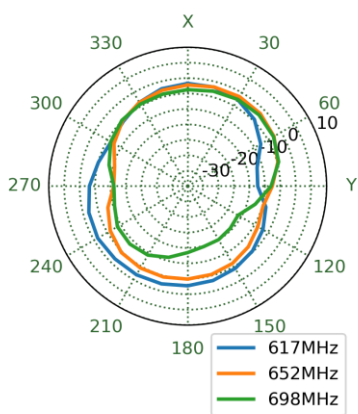

751MHz

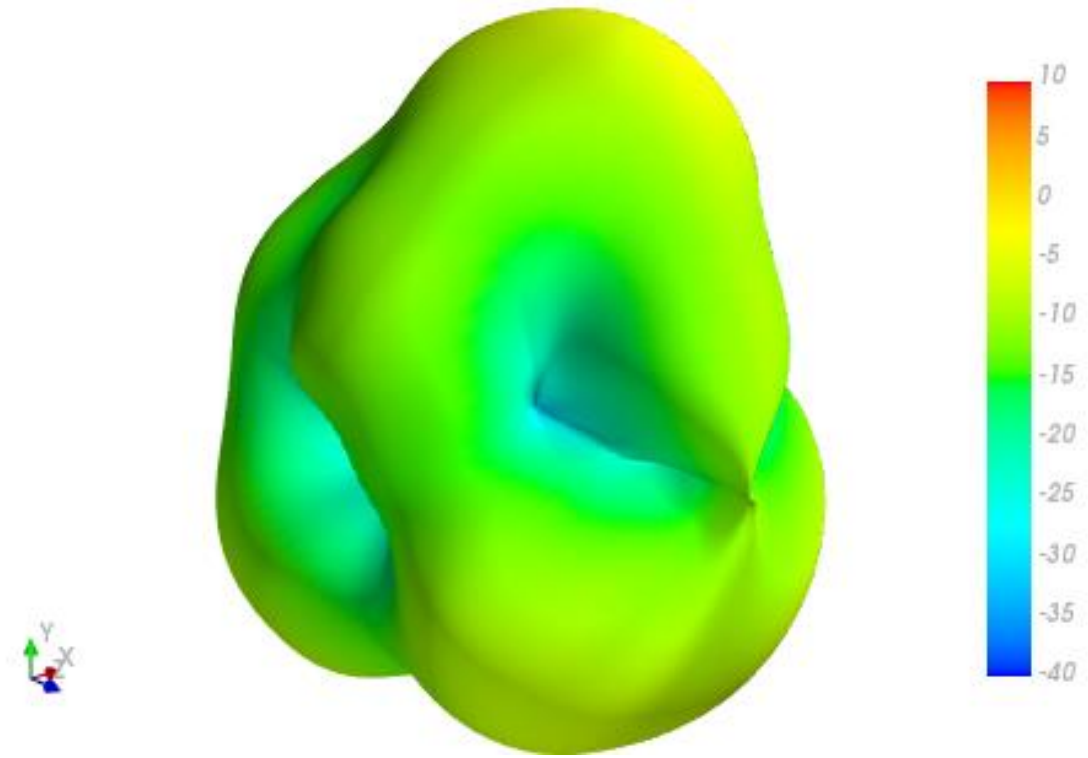

XY Plane XZ Plane YZ Plane

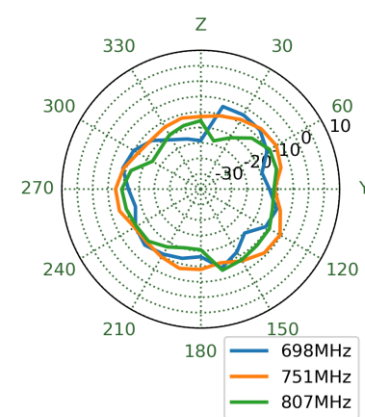
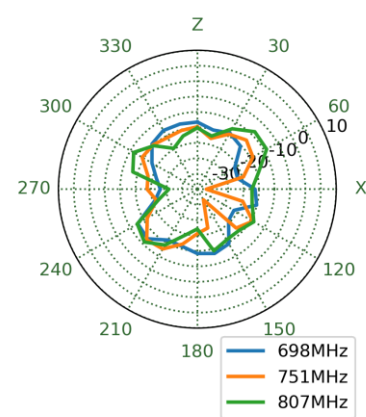
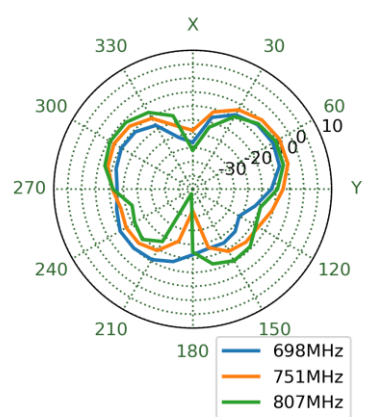

890MHz

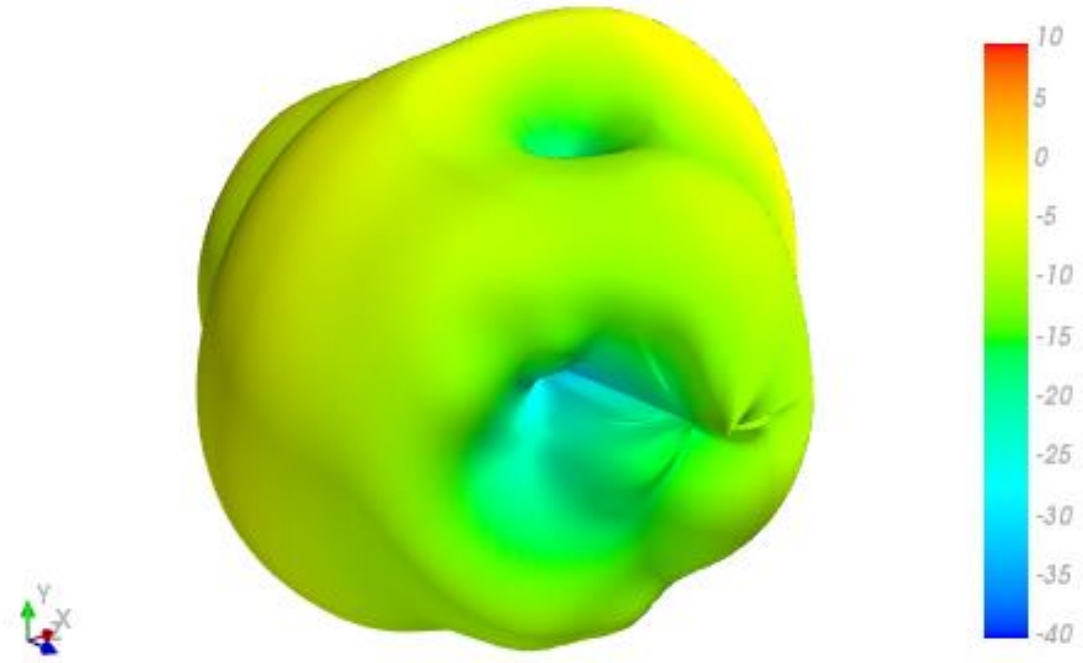

XY Plane XZ Plane YZ Plane

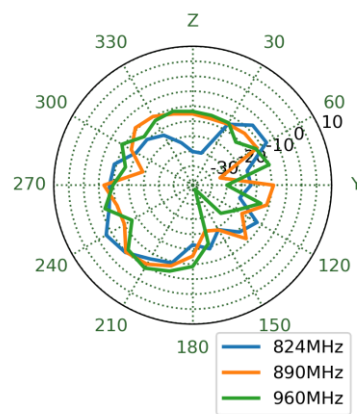
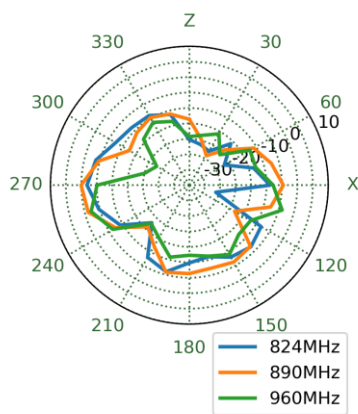
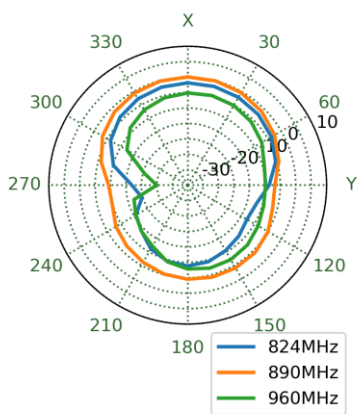

1470MHz

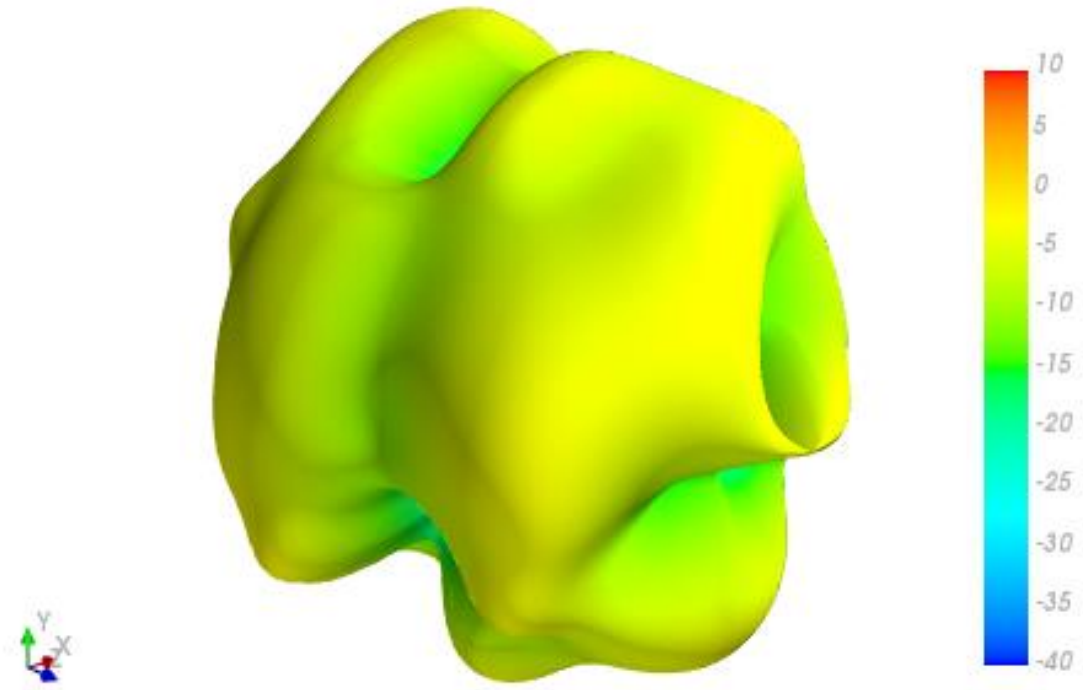

XY Plane XZ Plane YZ Plane

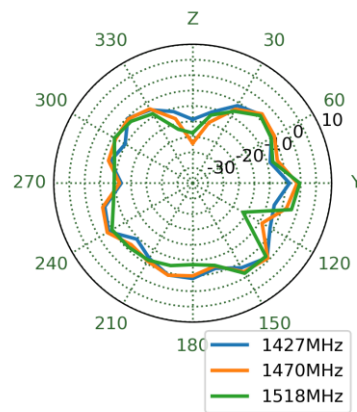
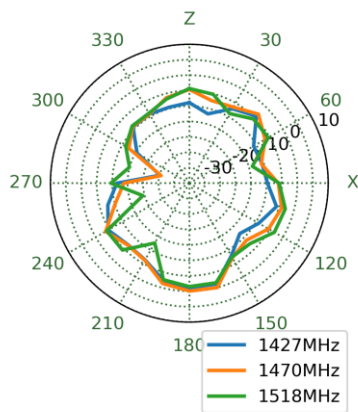
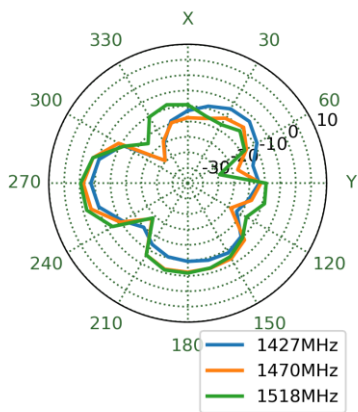

1805MHz

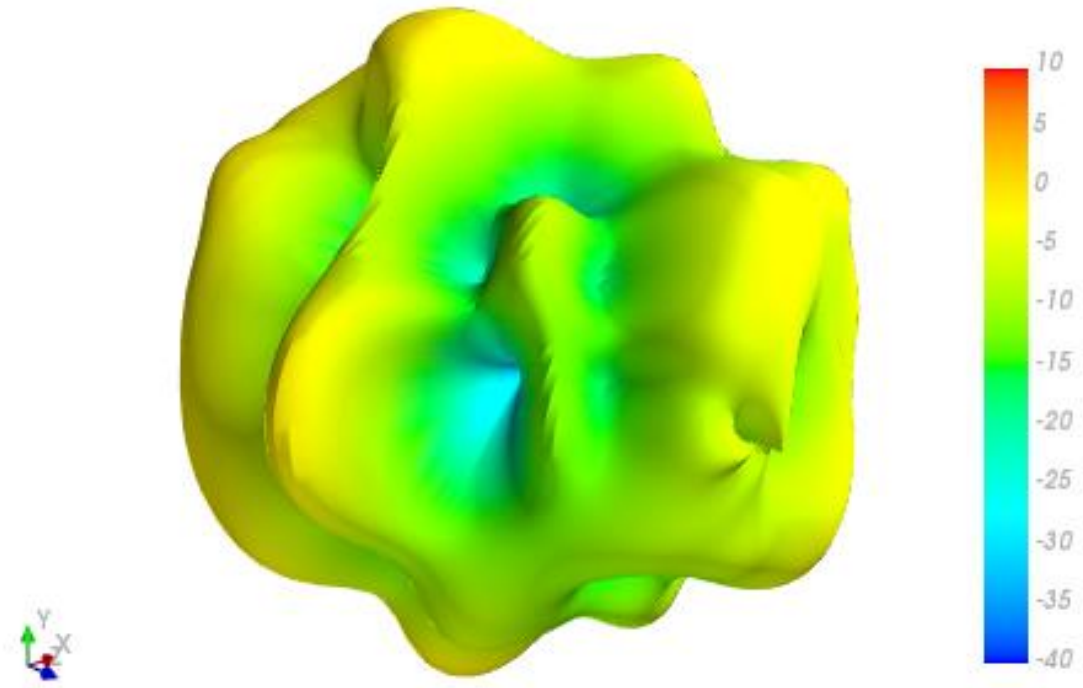

XY Plane XZ Plane YZ Plane

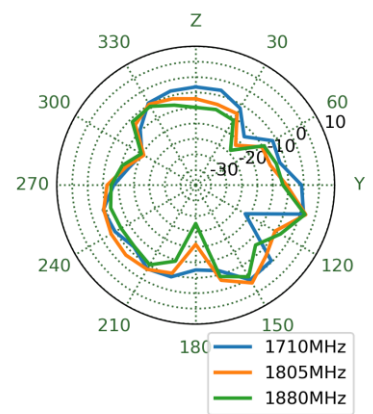
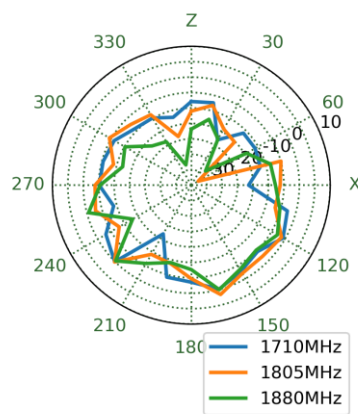
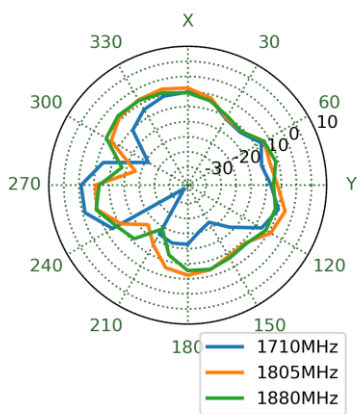

1920MHz

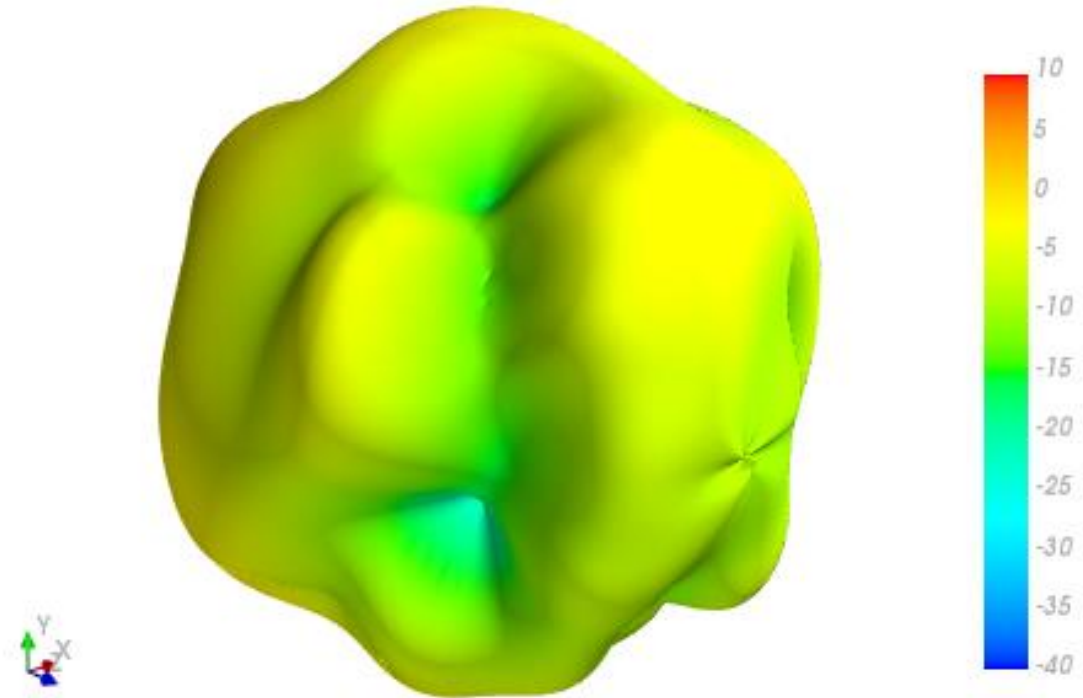

XY Plane XZ Plane YZ Plane

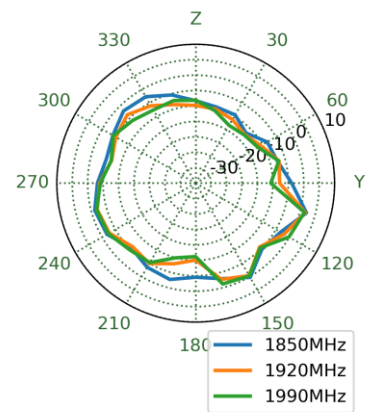
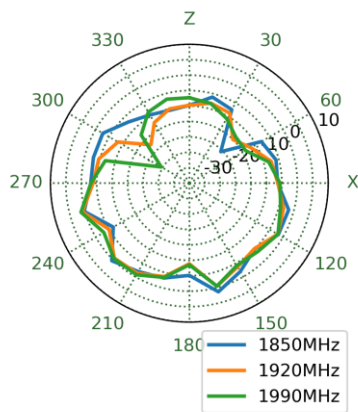
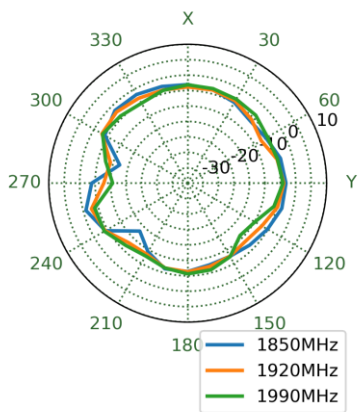

1990MHz

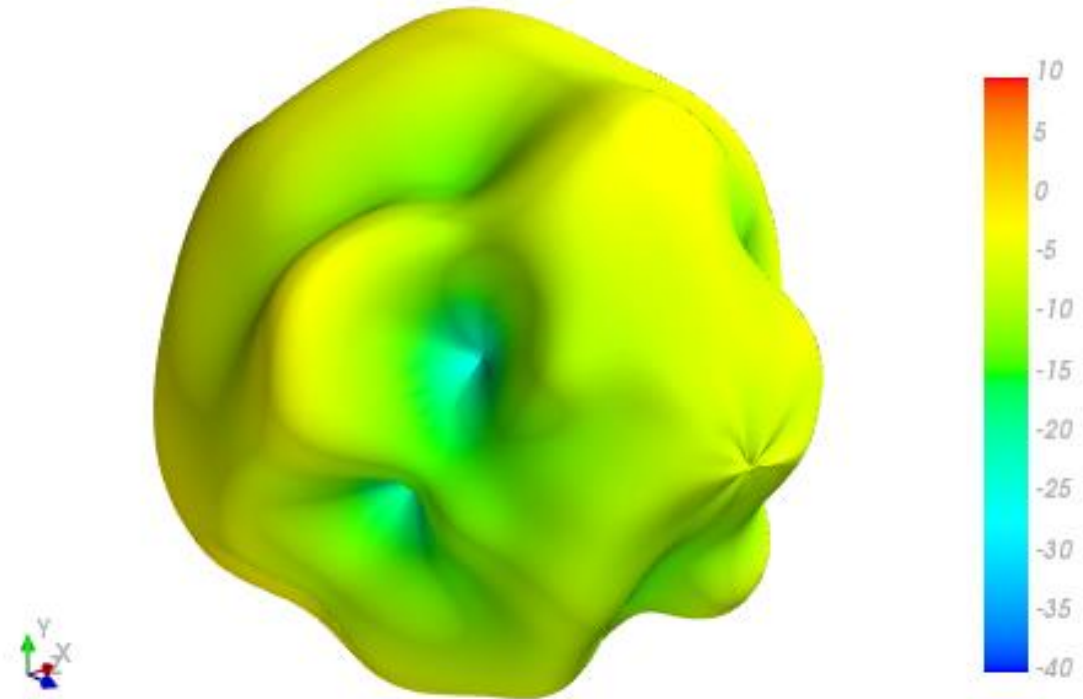

XY Plane XZ Plane YZ Plane

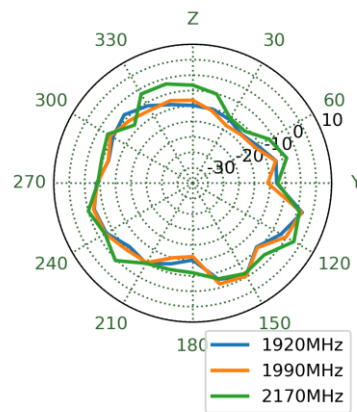
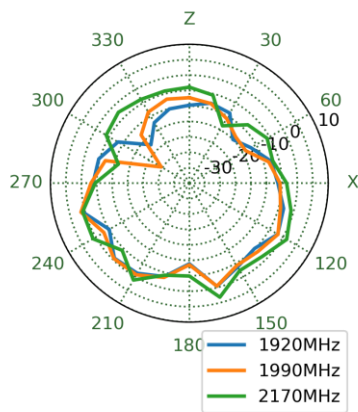
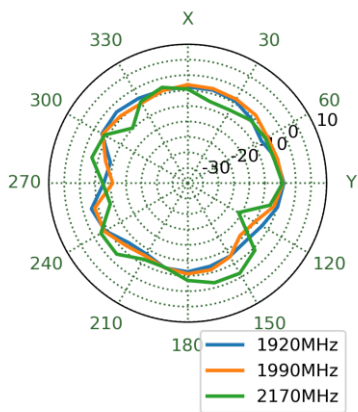

2595MHz

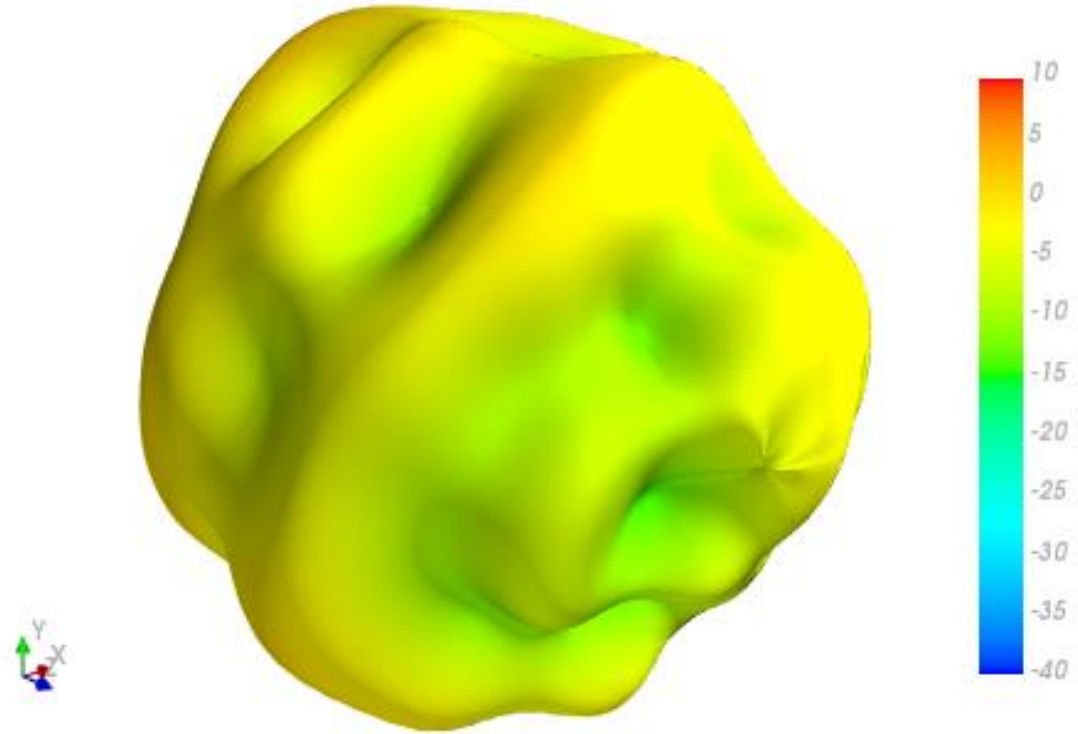

XY Plane XZ Plane YZ Plane

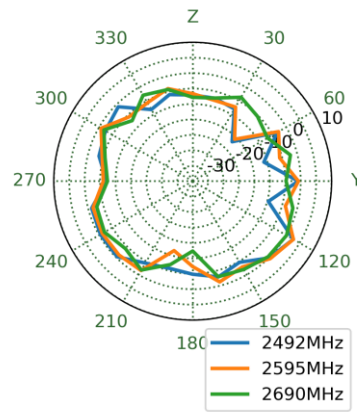
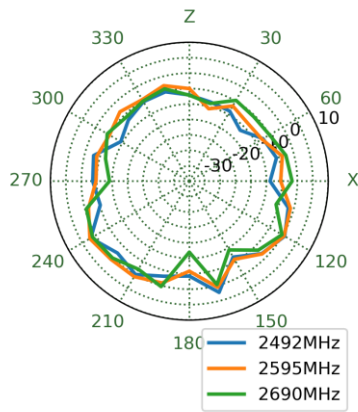
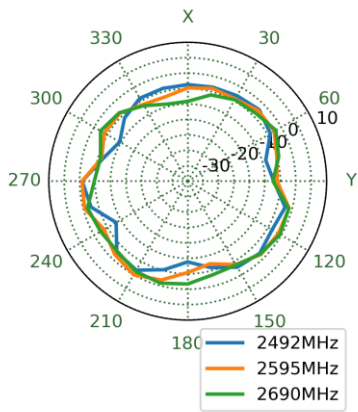

3400MHz

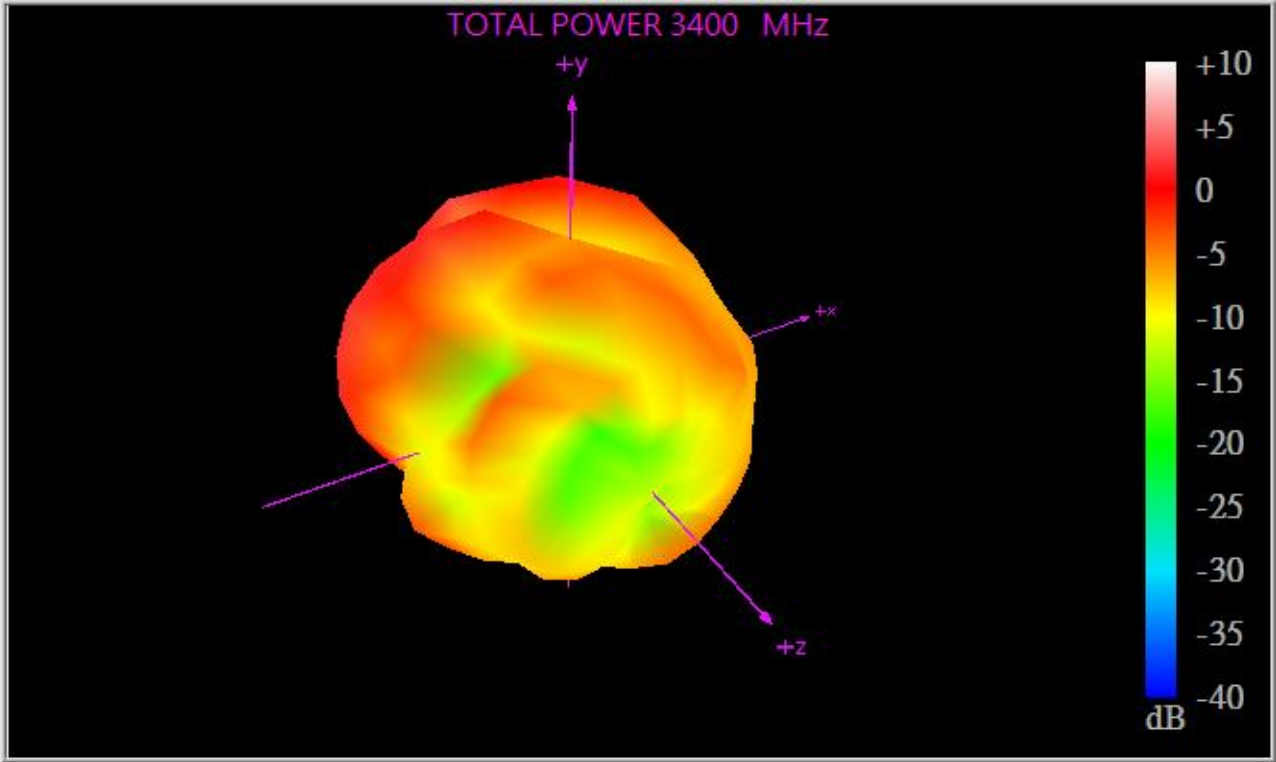

XY Plane XZ Plane YZ Plane

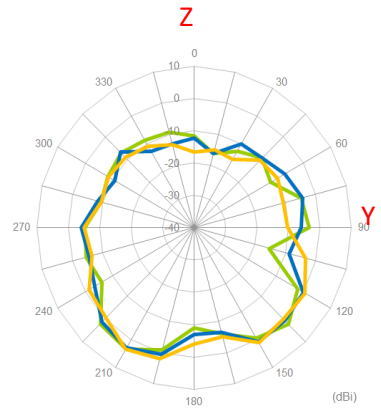
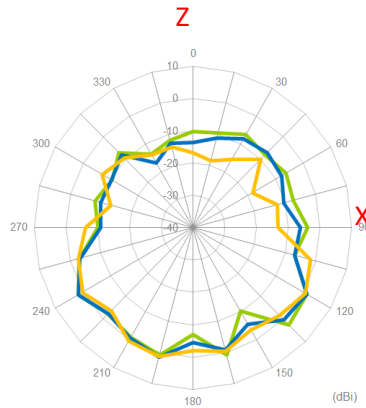
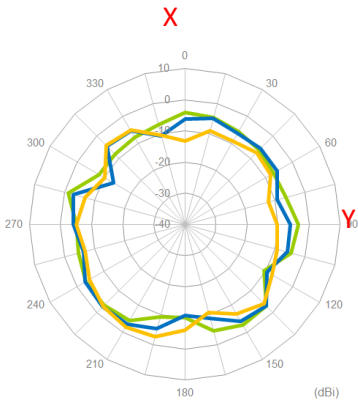

— 3300MHz

— 3400MHz

— 3500MHz

5.3 Radiation Patterns – 5G/4G 30x30cm Ground Plane

652MHz

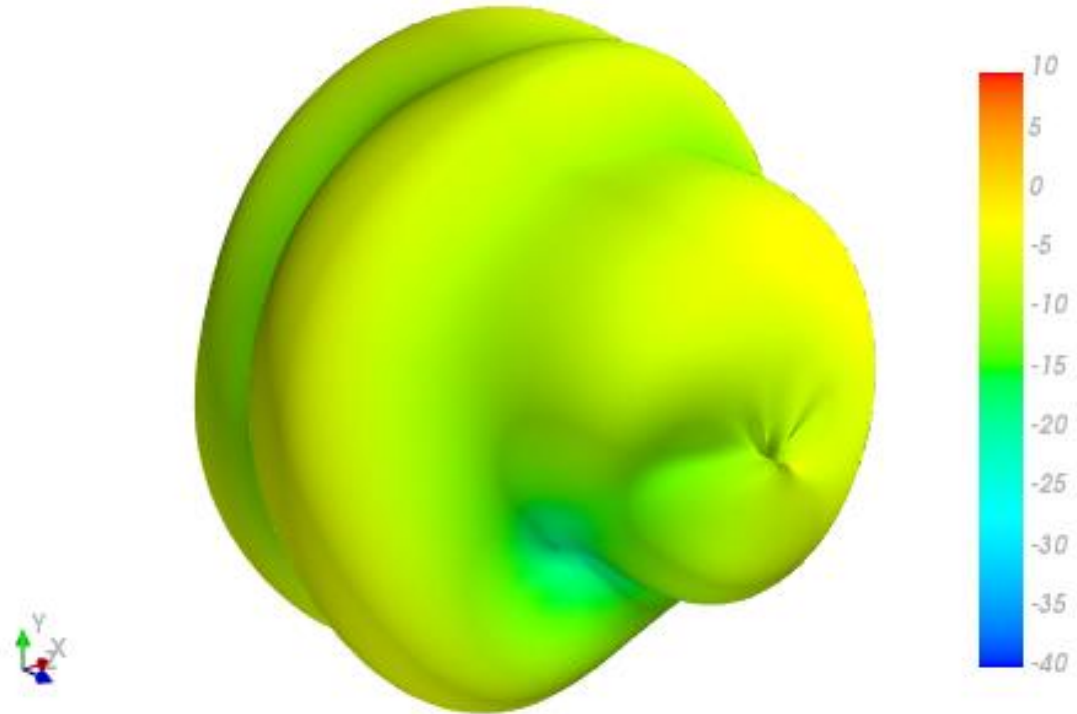

XY Plane XZ Plane YZ Plane

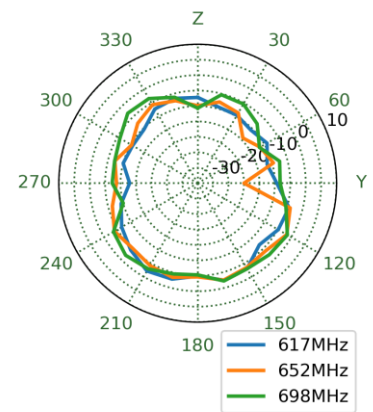
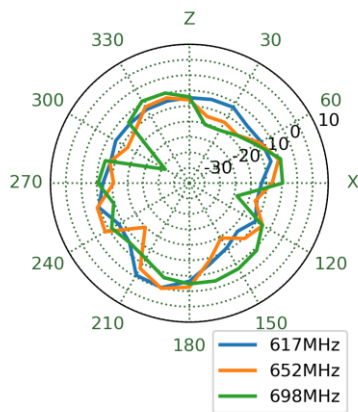
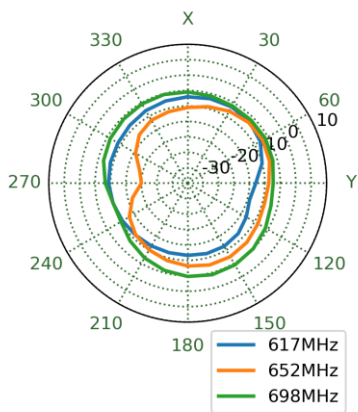

751MHz

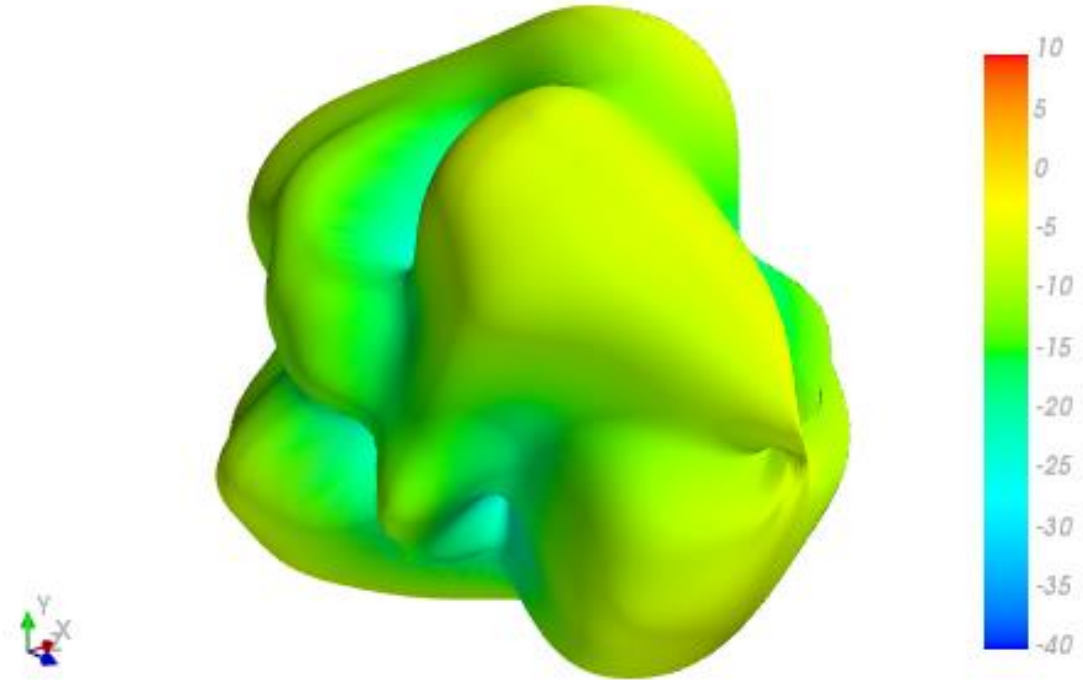

XY Plane XZ Plane YZ Plane

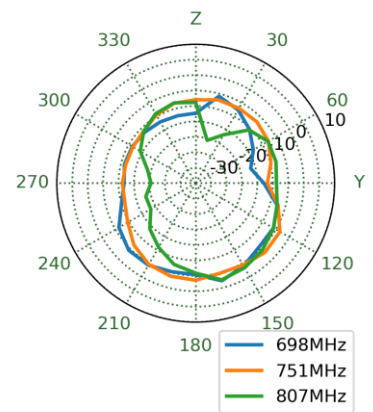
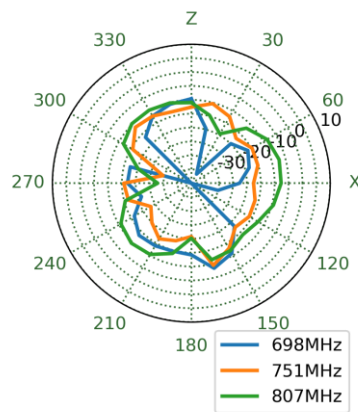
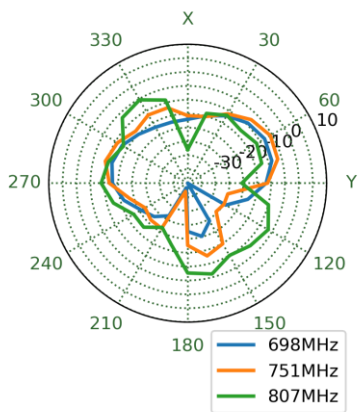

890MHz

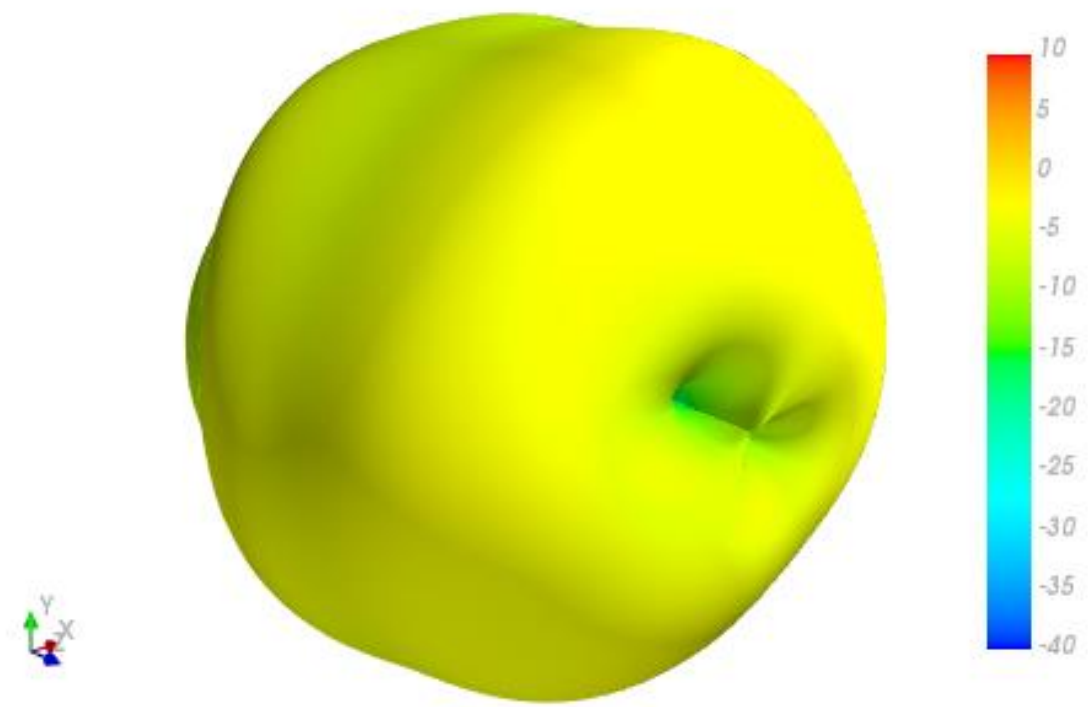

XY Plane XZ Plane YZ Plane

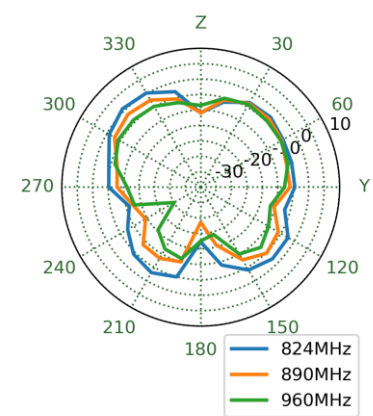
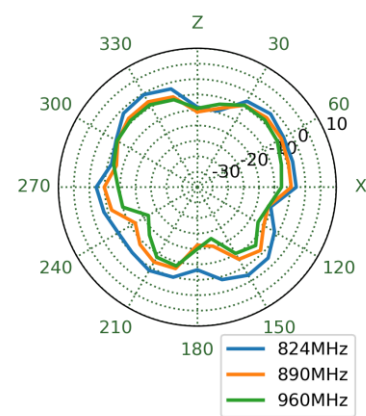
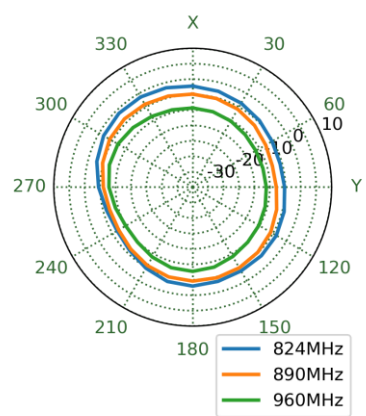

1470MHz

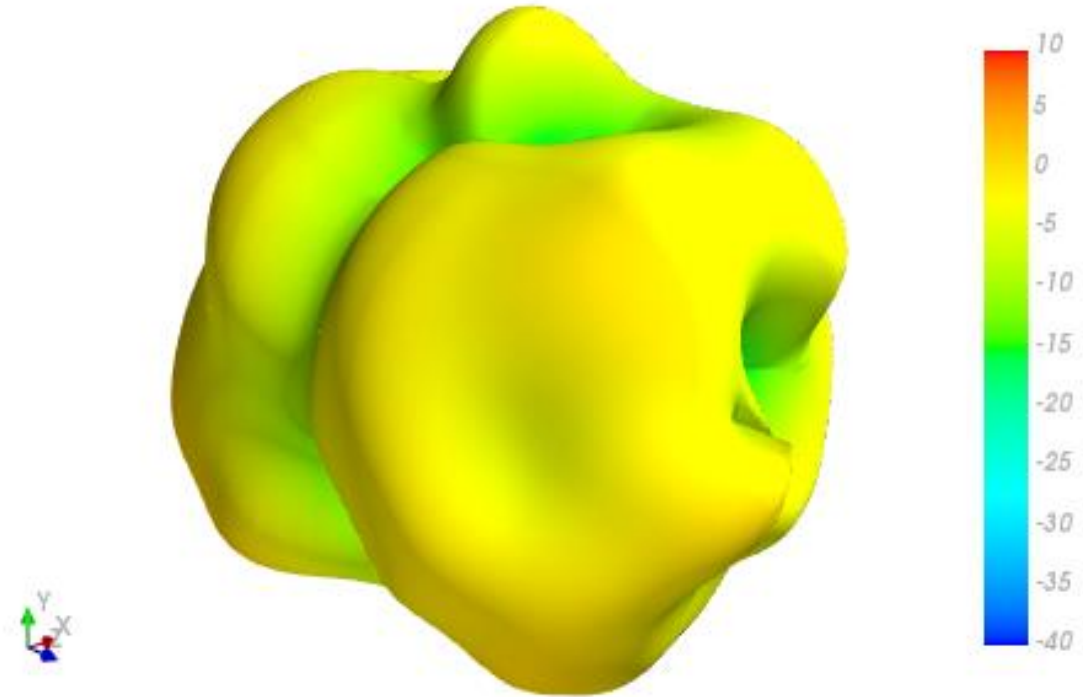

XY Plane XZ Plane YZ Plane

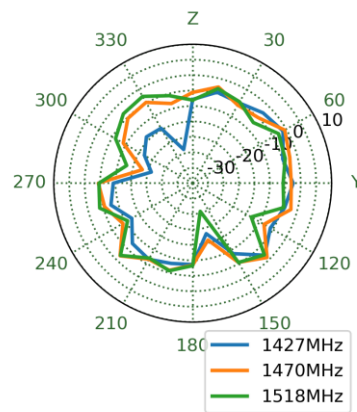
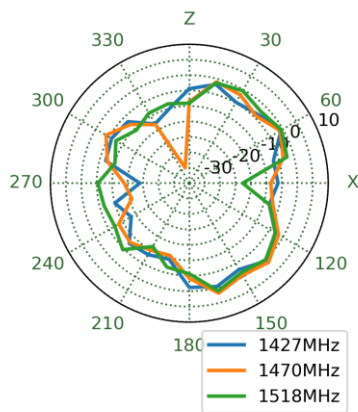
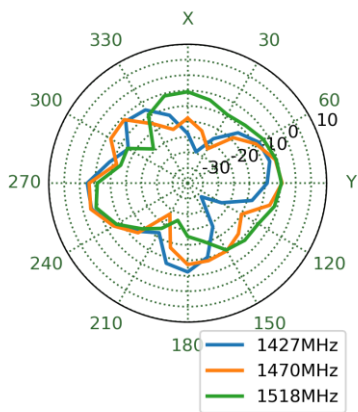

1805MHz

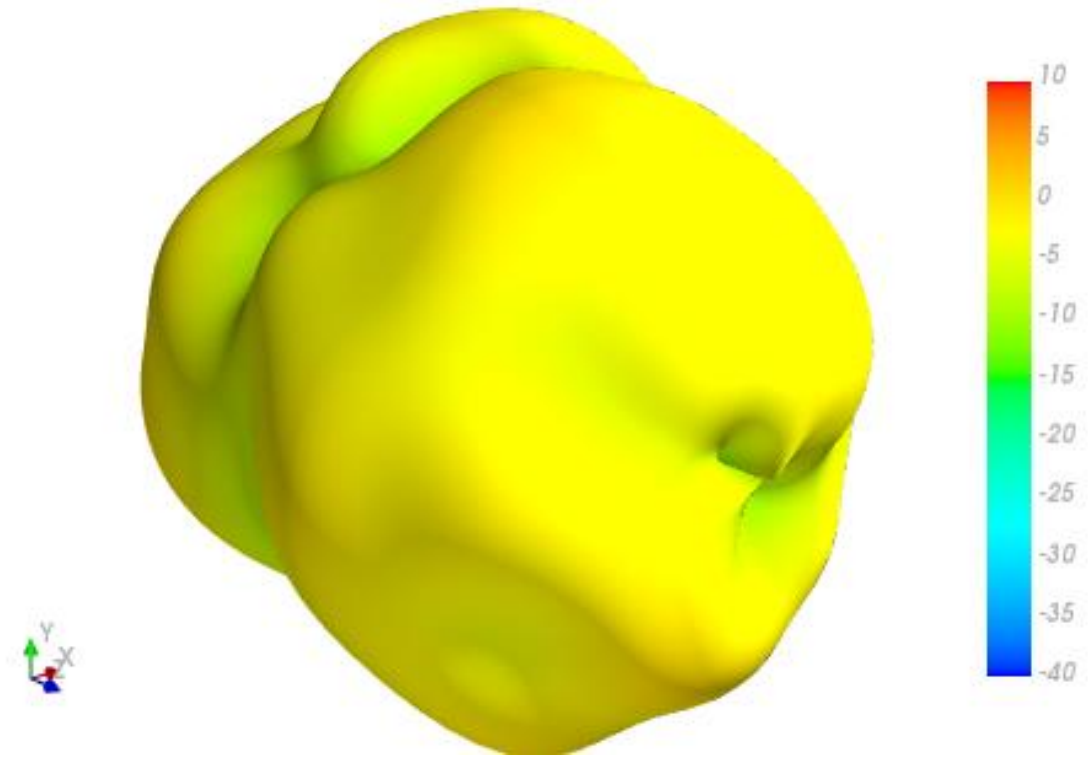

XY Plane XZ Plane YZ Plane

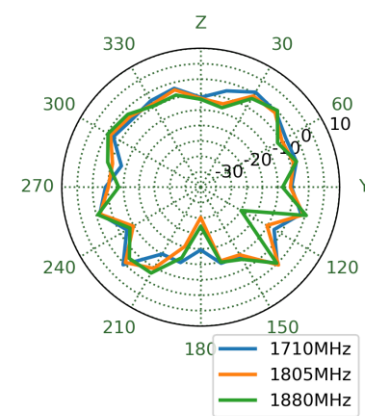
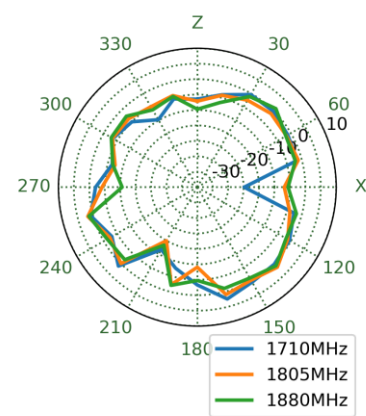
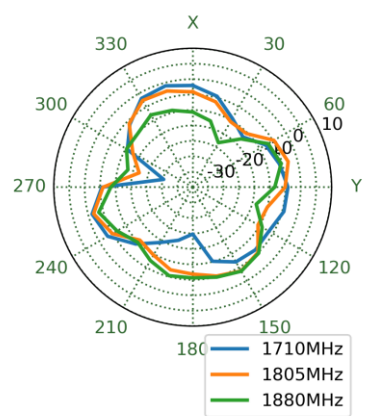

1920MHz

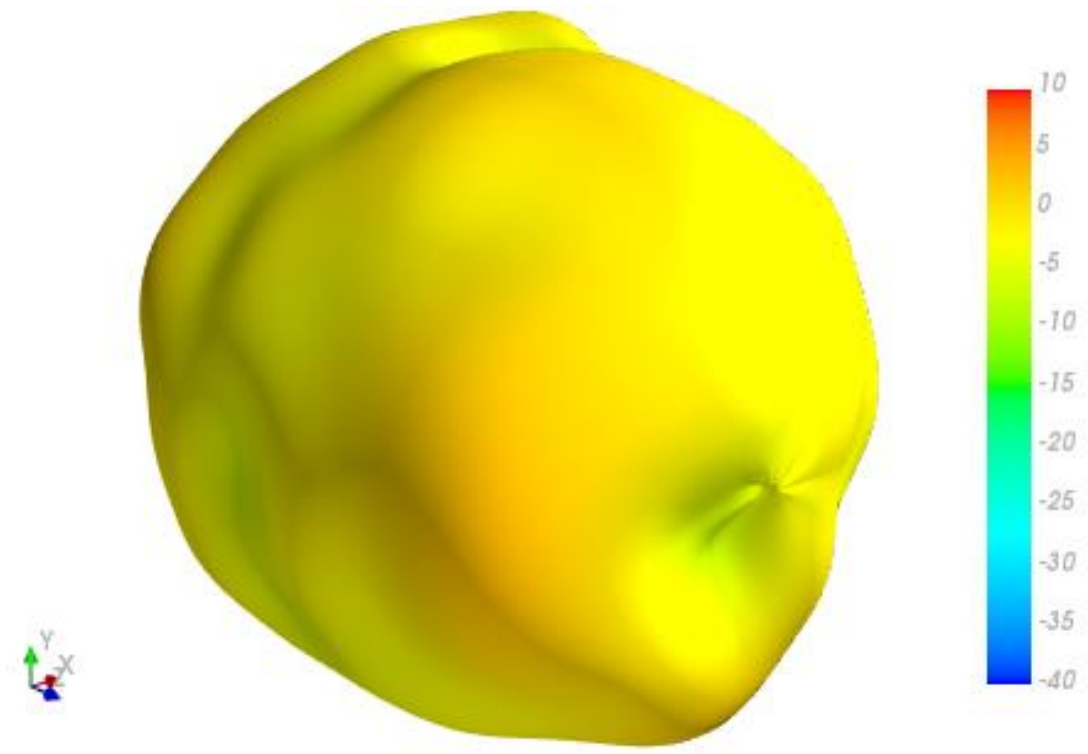

XY Plane XZ Plane YZ Plane

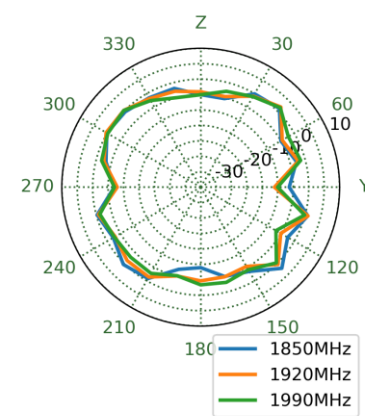
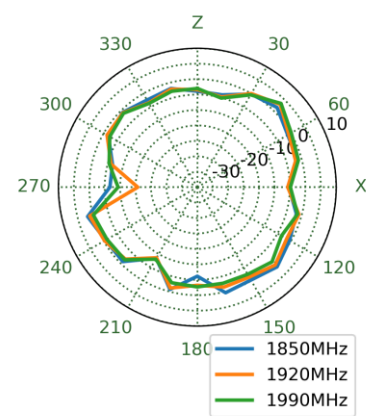
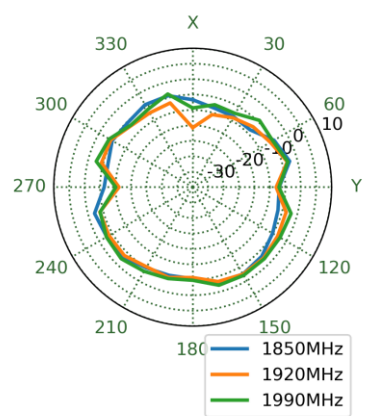

1990MHz

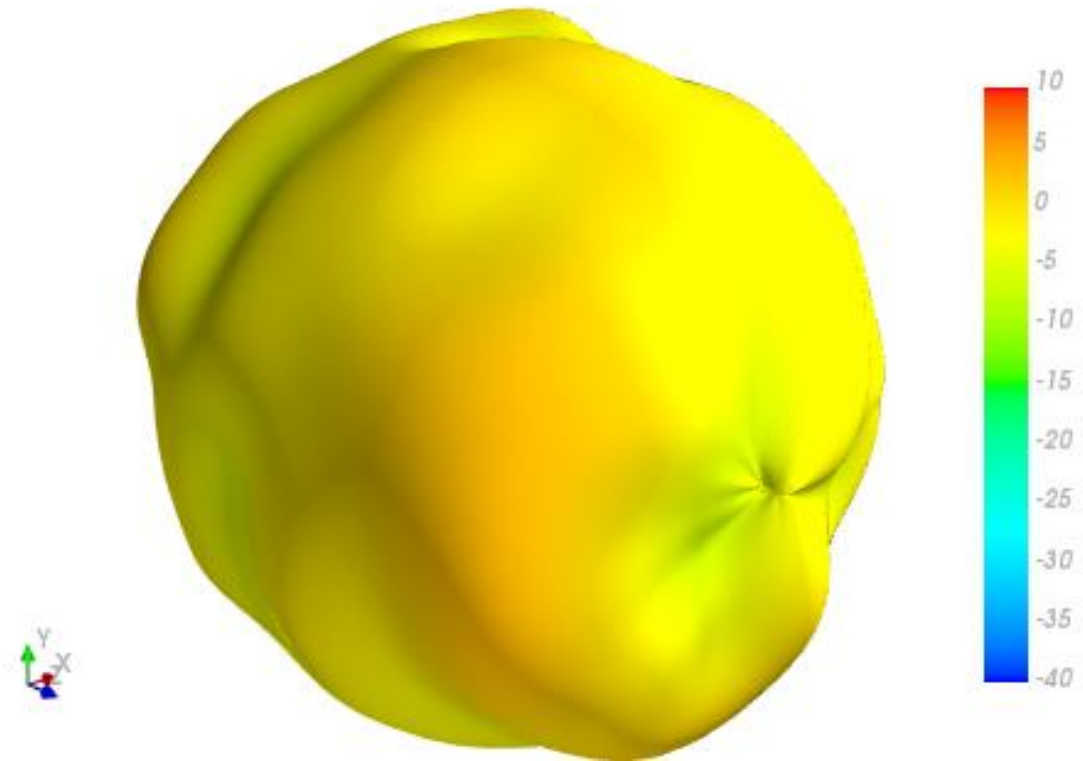

XY Plane XZ Plane YZ Plane

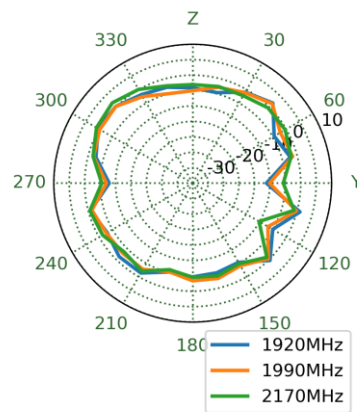
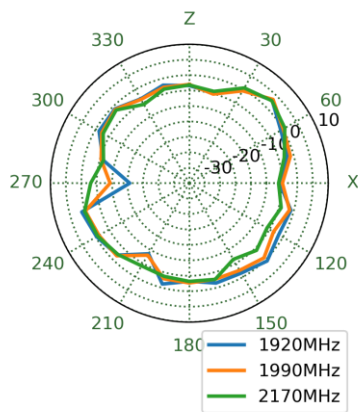
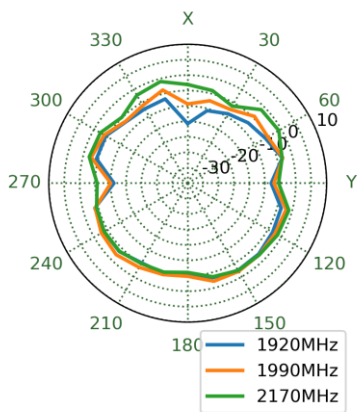

2595MHz

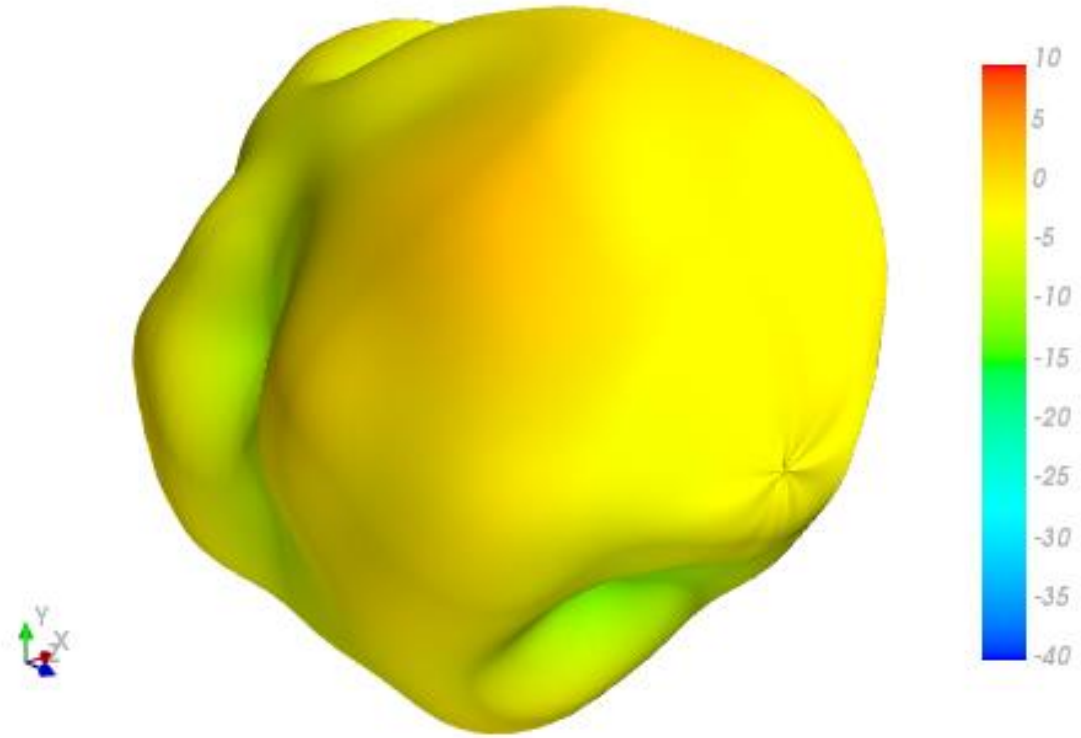

XY Plane XZ Plane YZ Plane

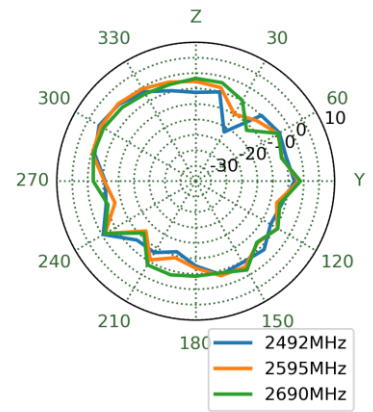
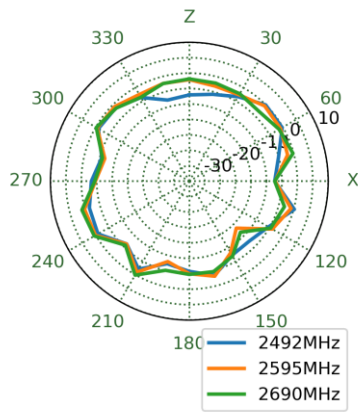
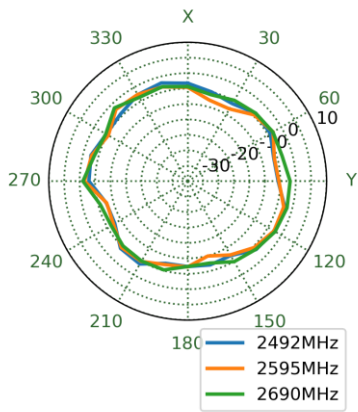

3400MHz

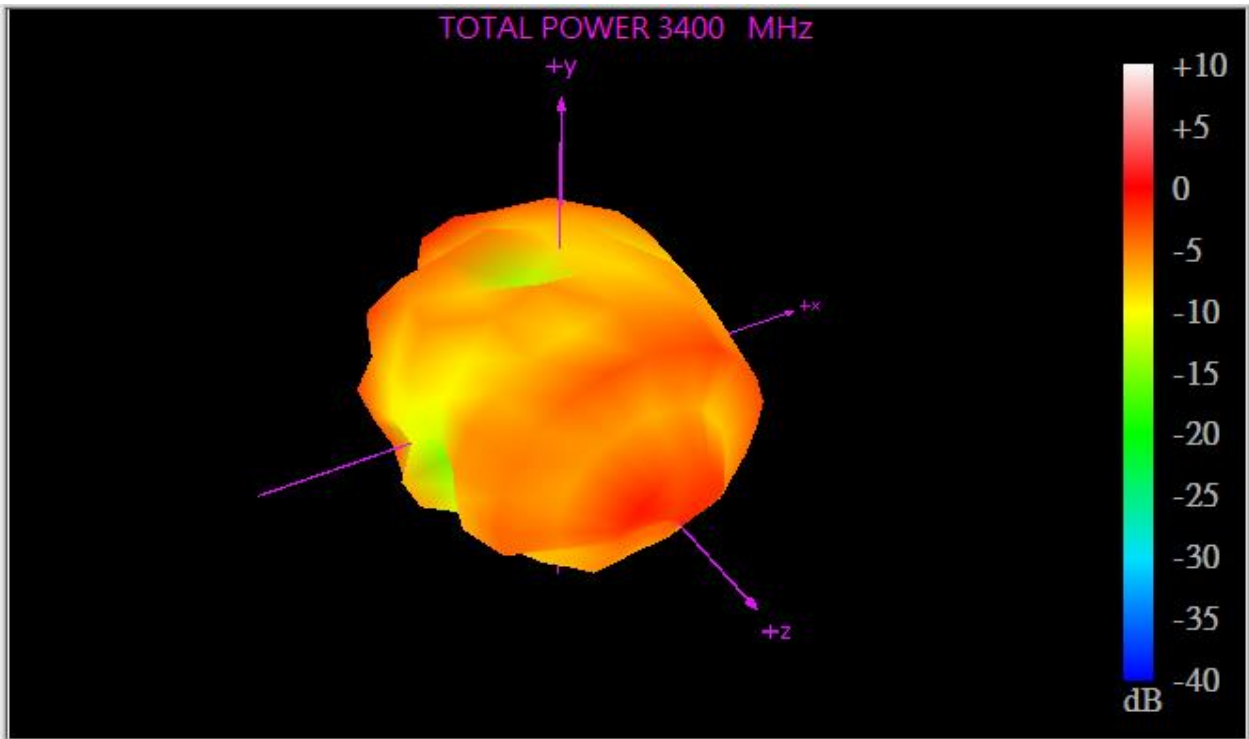

2D Pattern

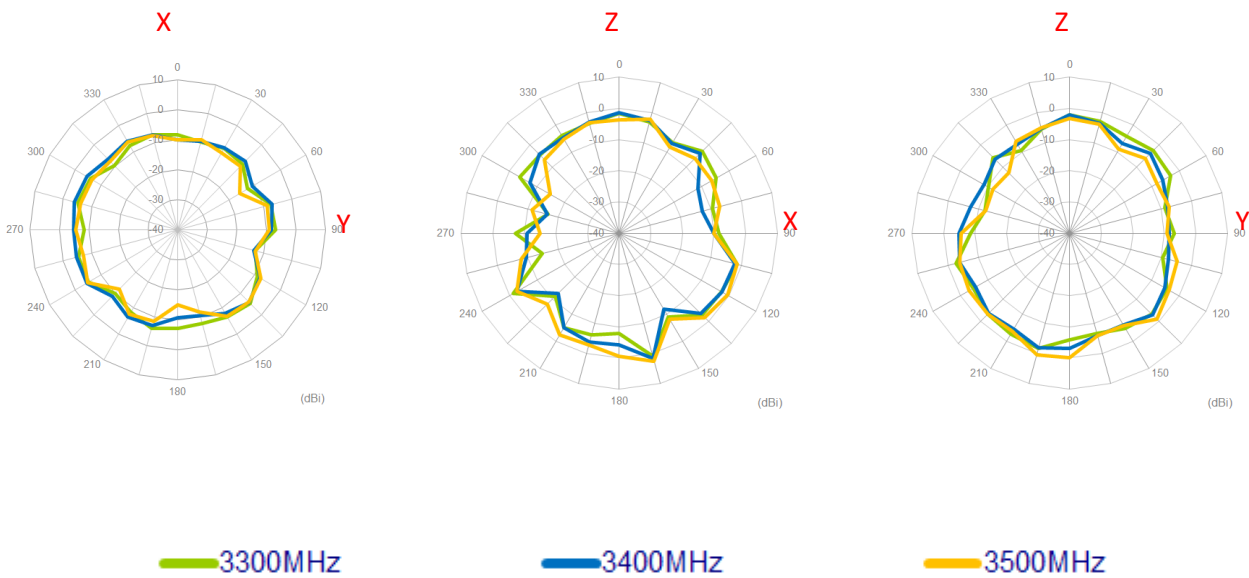

5.4 Radiation Patterns – Wi-Fi Free Space

2450MHz

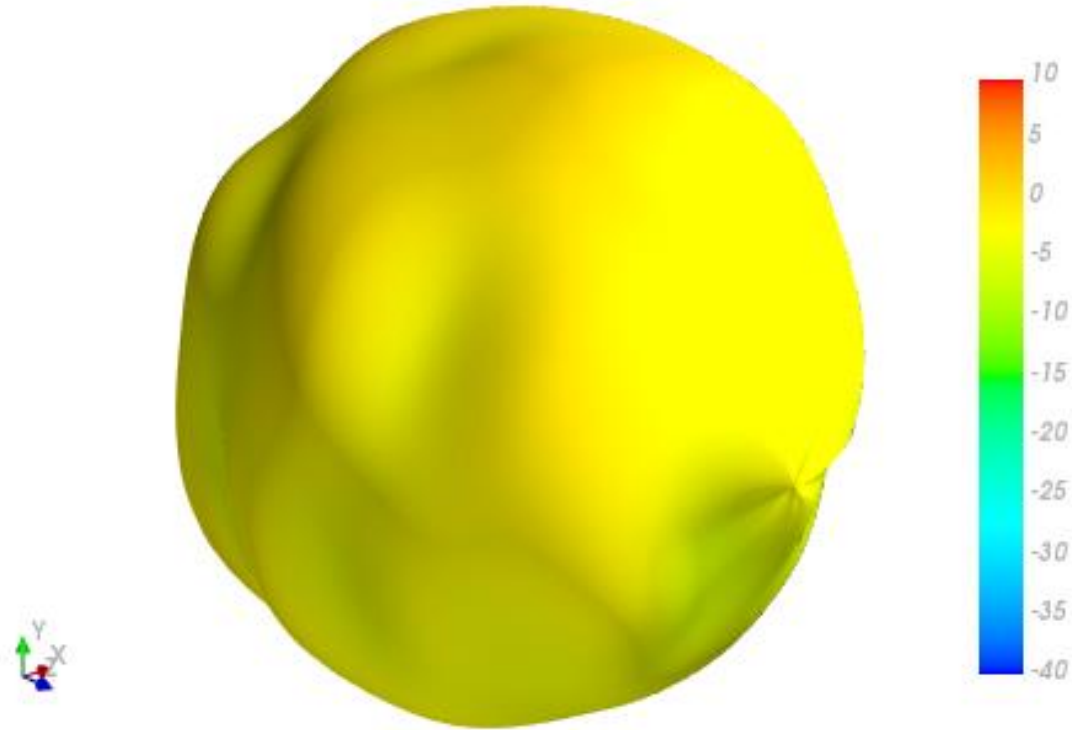

XY Plane XZ Plane YZ Plane

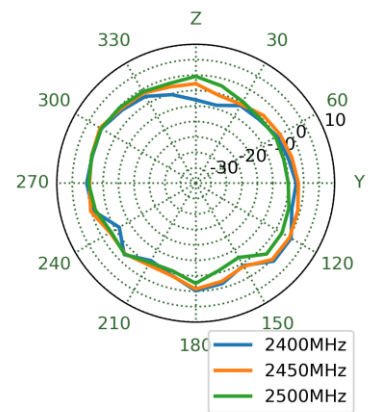
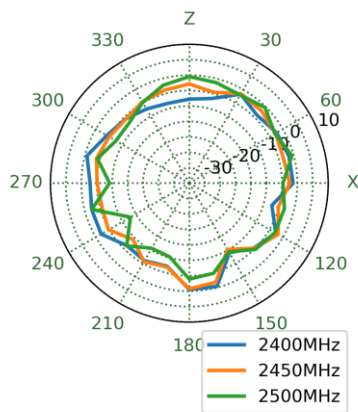
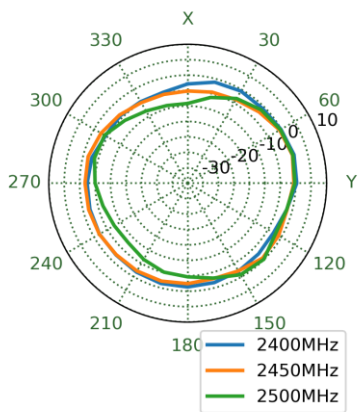

5550MHz

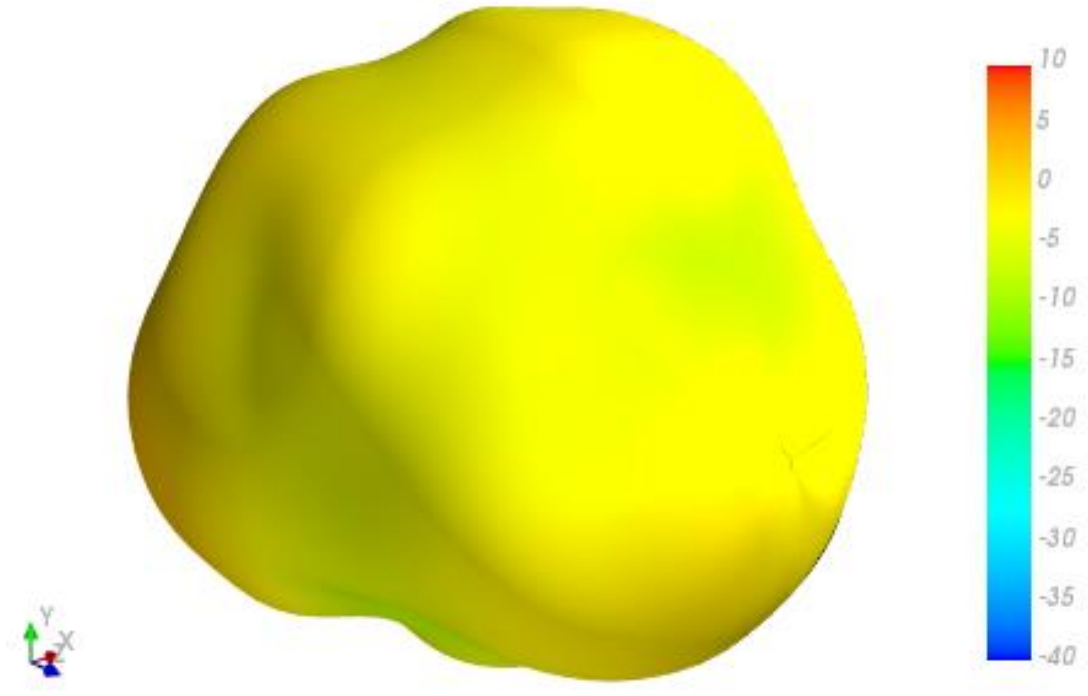

XY Plane XZ Plane YZ Plane

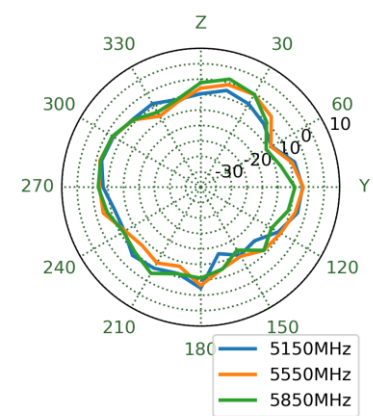
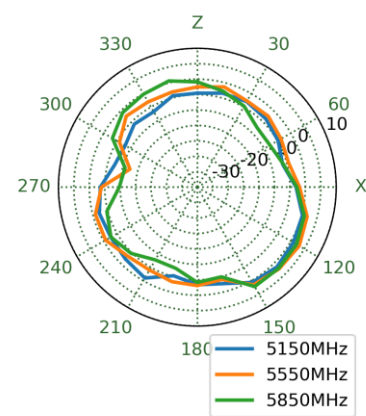
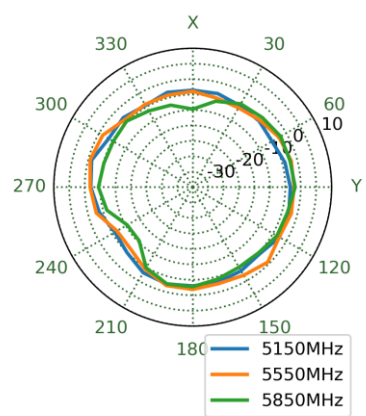

5.5 Radiation Patterns – Wi-Fi 30x30cm Ground Plane

2450MHz

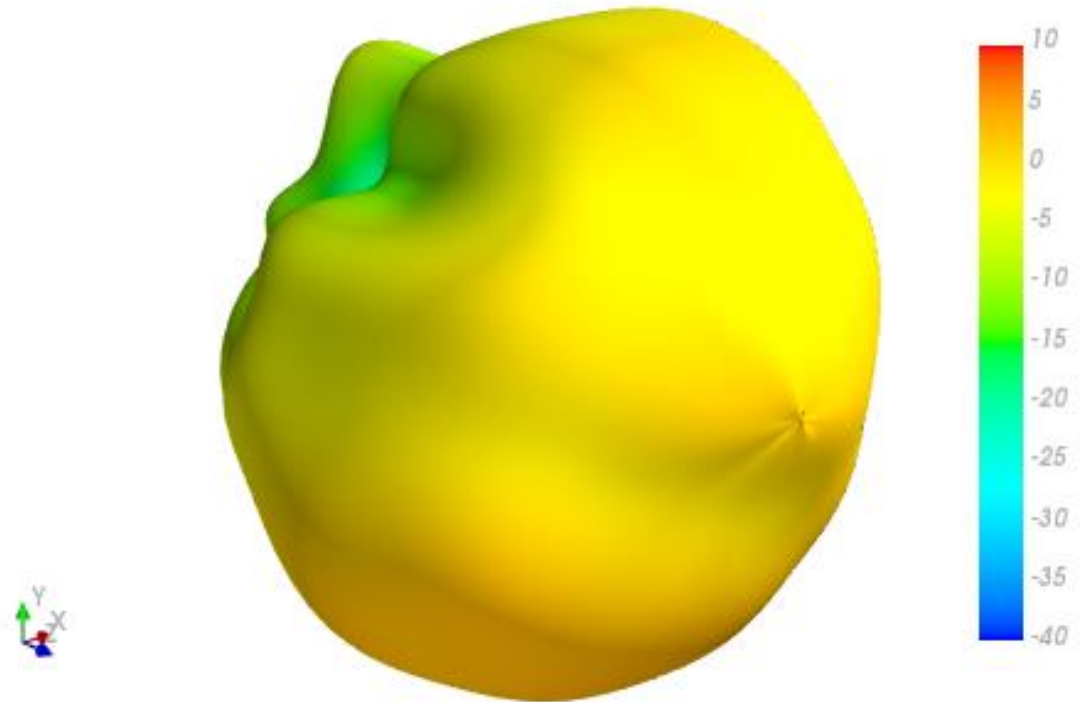

XY Plane XZ Plane YZ Plane

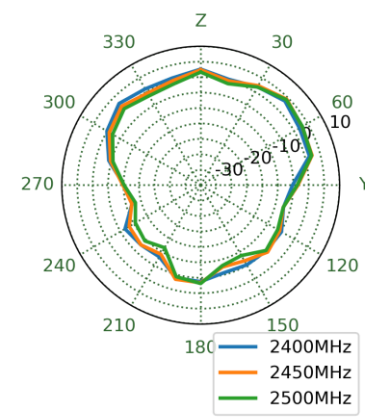
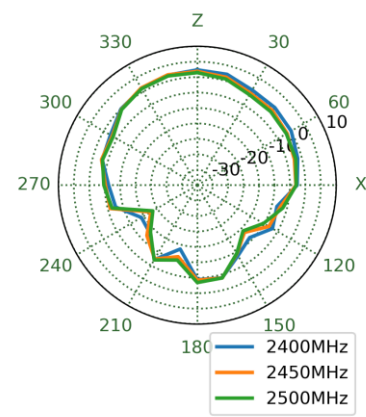
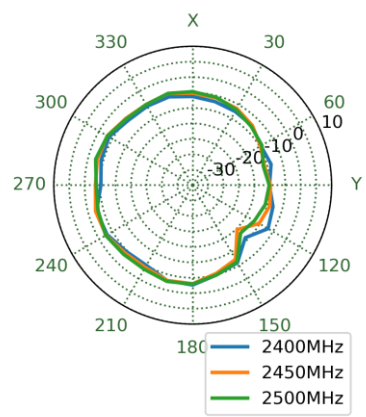

5550MHz

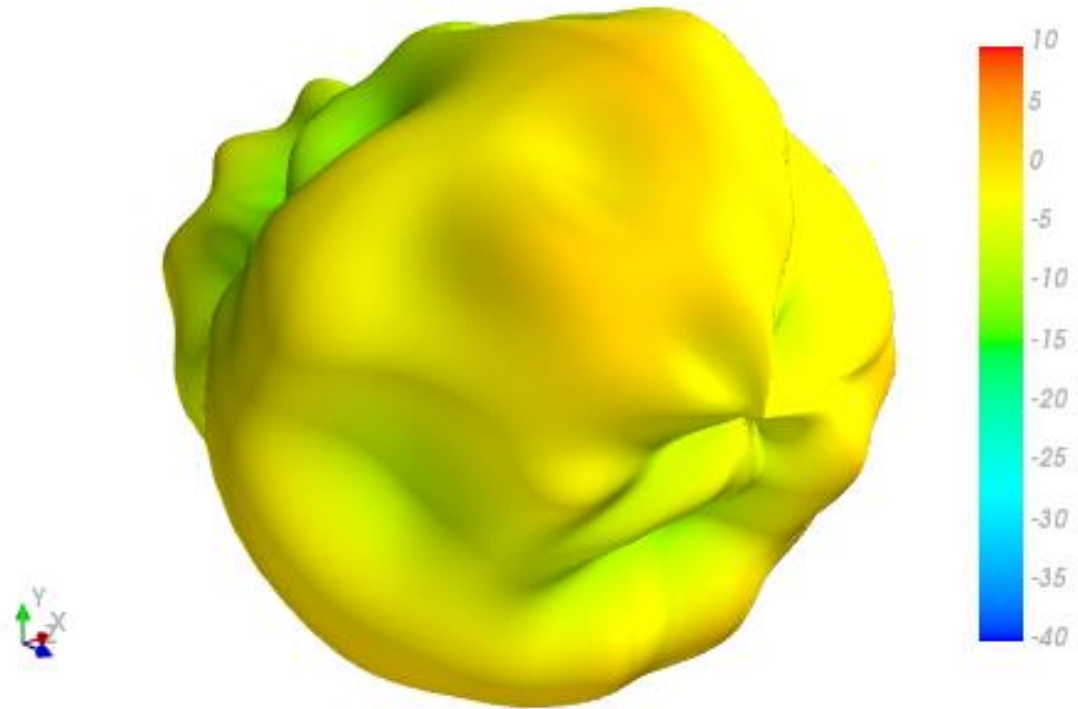

XY Plane XZ Plane YZ Plane

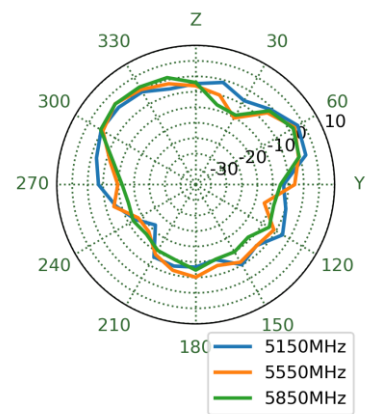
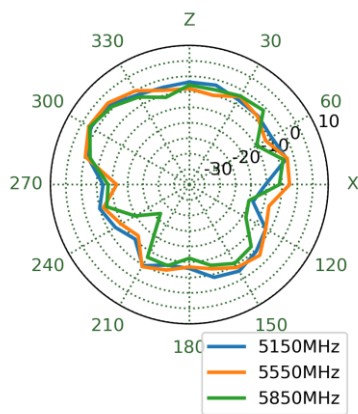
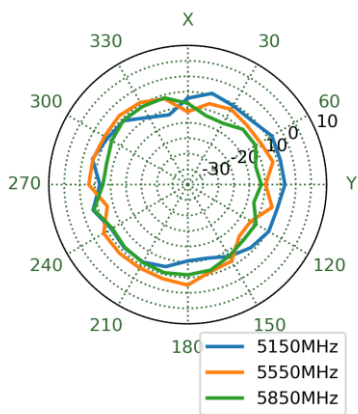

6. Mechanical Drawing (Units: mm)

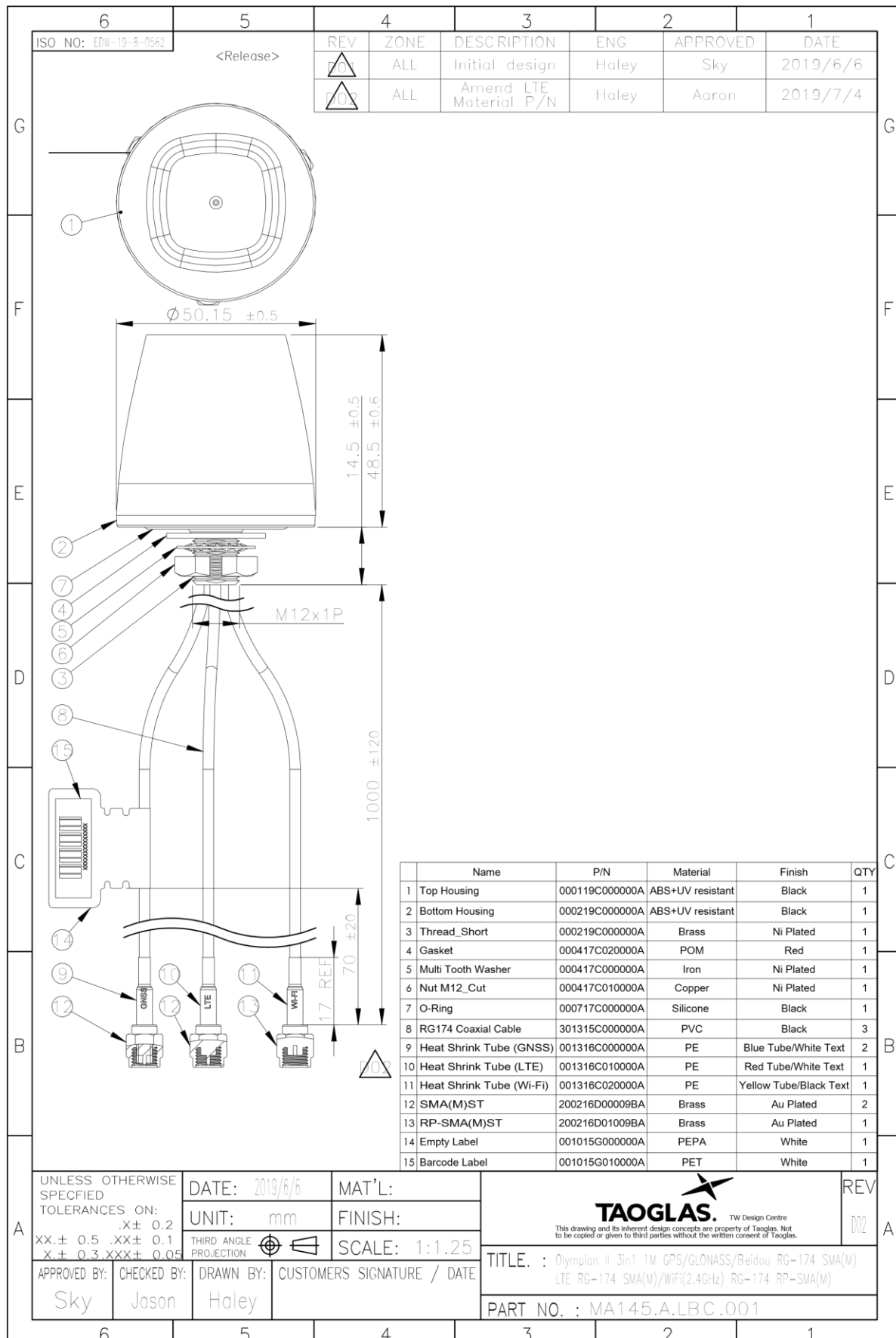

7. Packaging

1pc MA145.A.LBC.001 per PE Bag
Weight - 100g

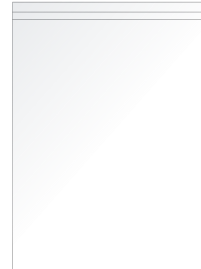

10pcs MA145.A.LBC.001 per Large PE Bag
Weight – 1.1Kg

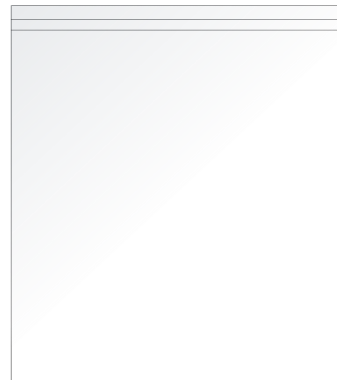

100pcs MA145.A.LBC.001 per Carton
Dimensions - 370*370*300mm
Weight – 11.86Kg

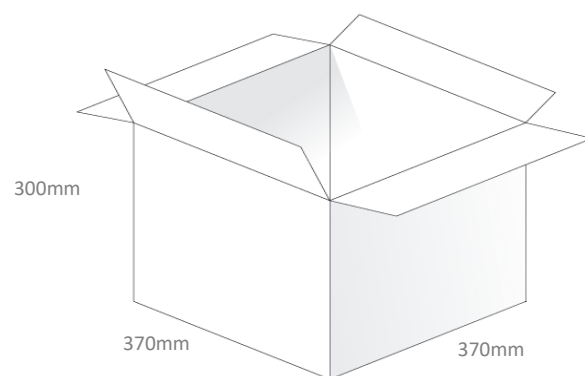

8. Application Note

The MA145 antenna performance with different cable lengths is shown below.

8.1 Return Loss In Free Space

LTE

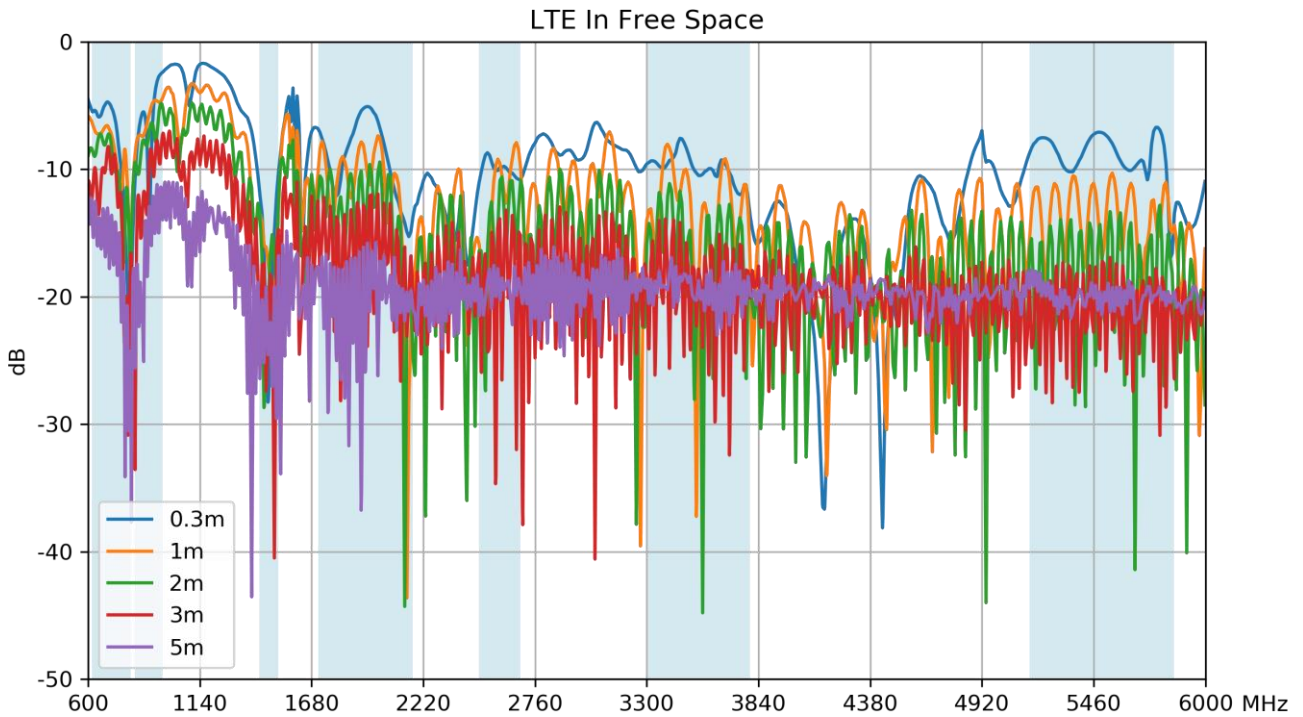

Wi-Fi

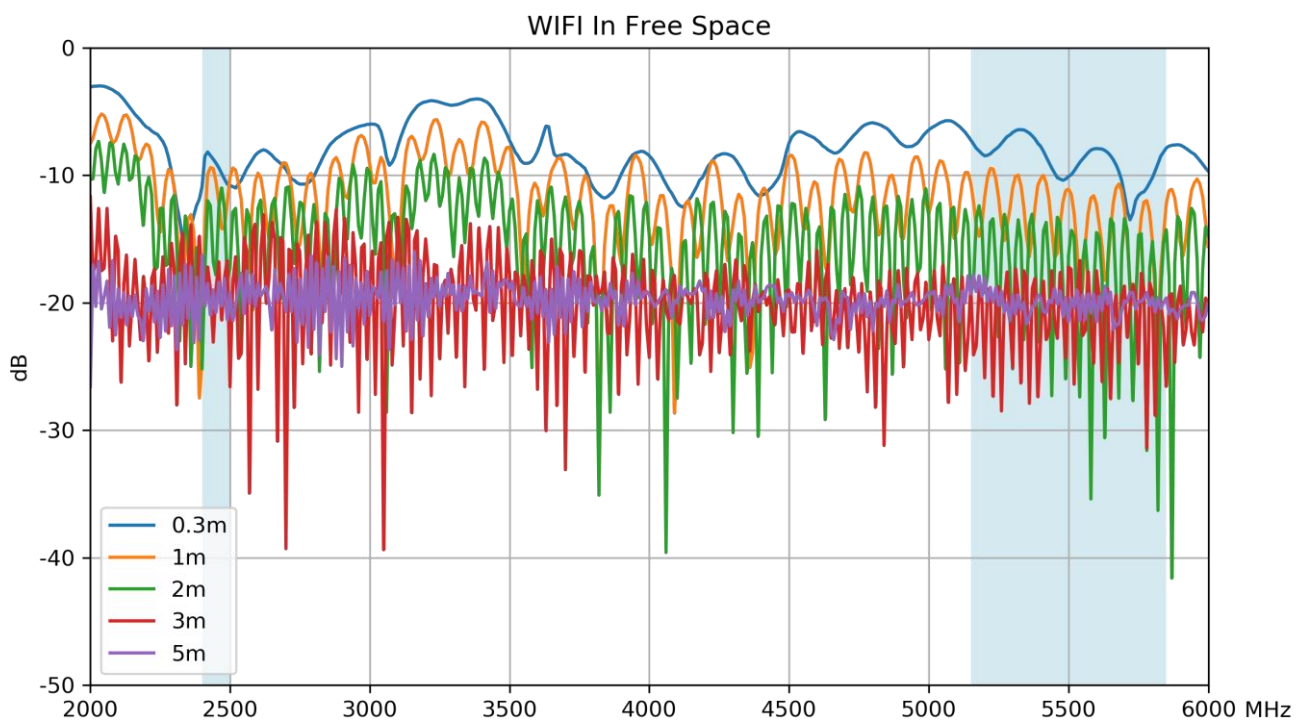

8.2 Efficiency In Free Space

LTE

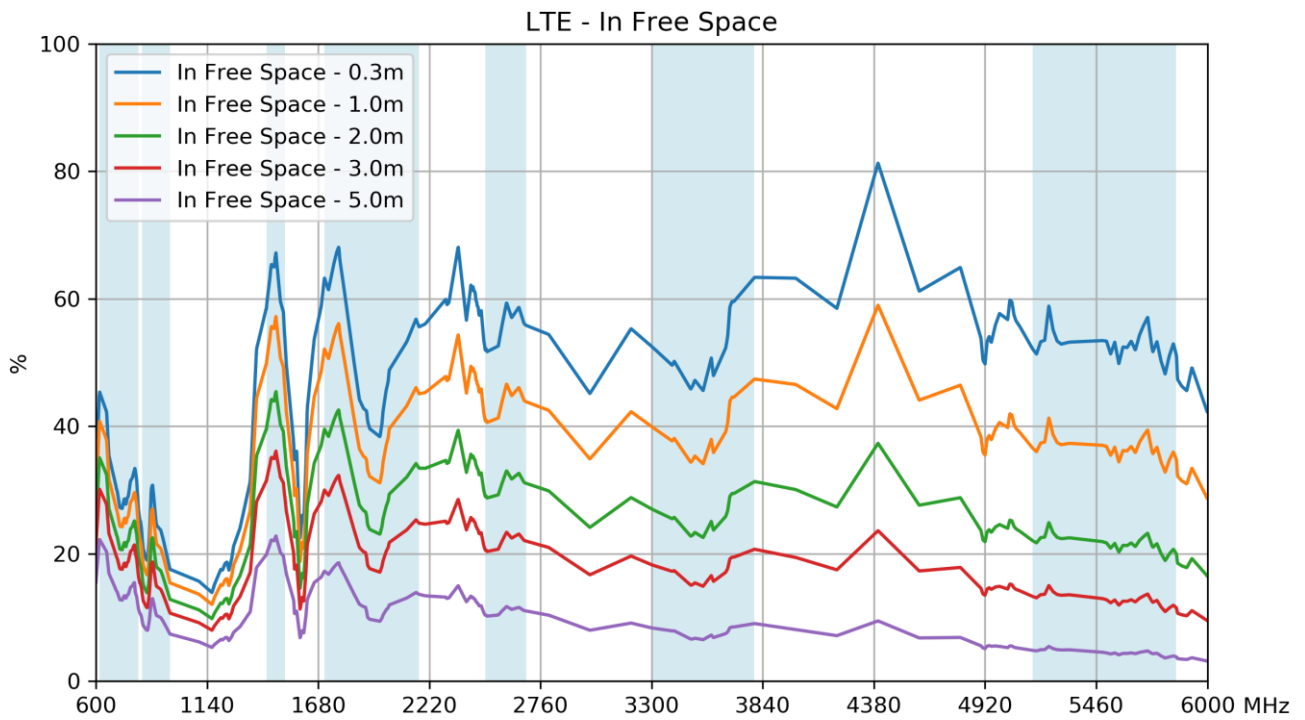

Wi-Fi

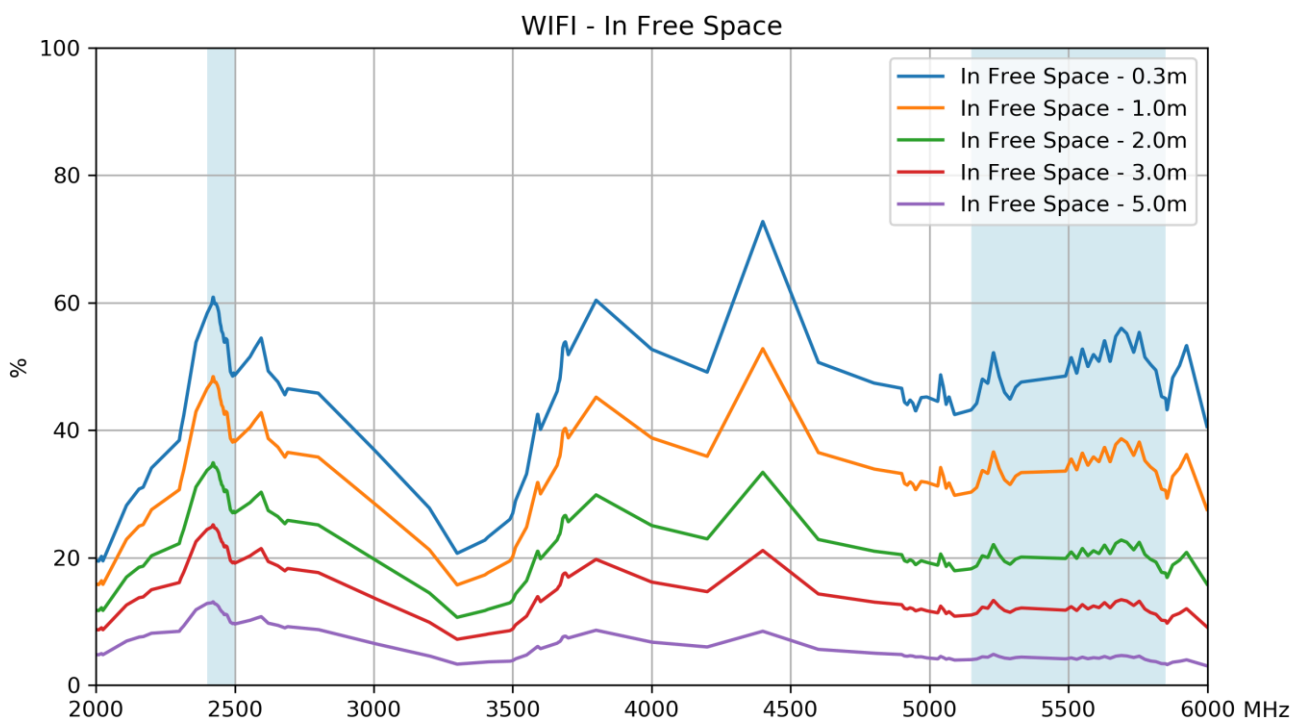

8.3 Average Gain In Free Space

LTE

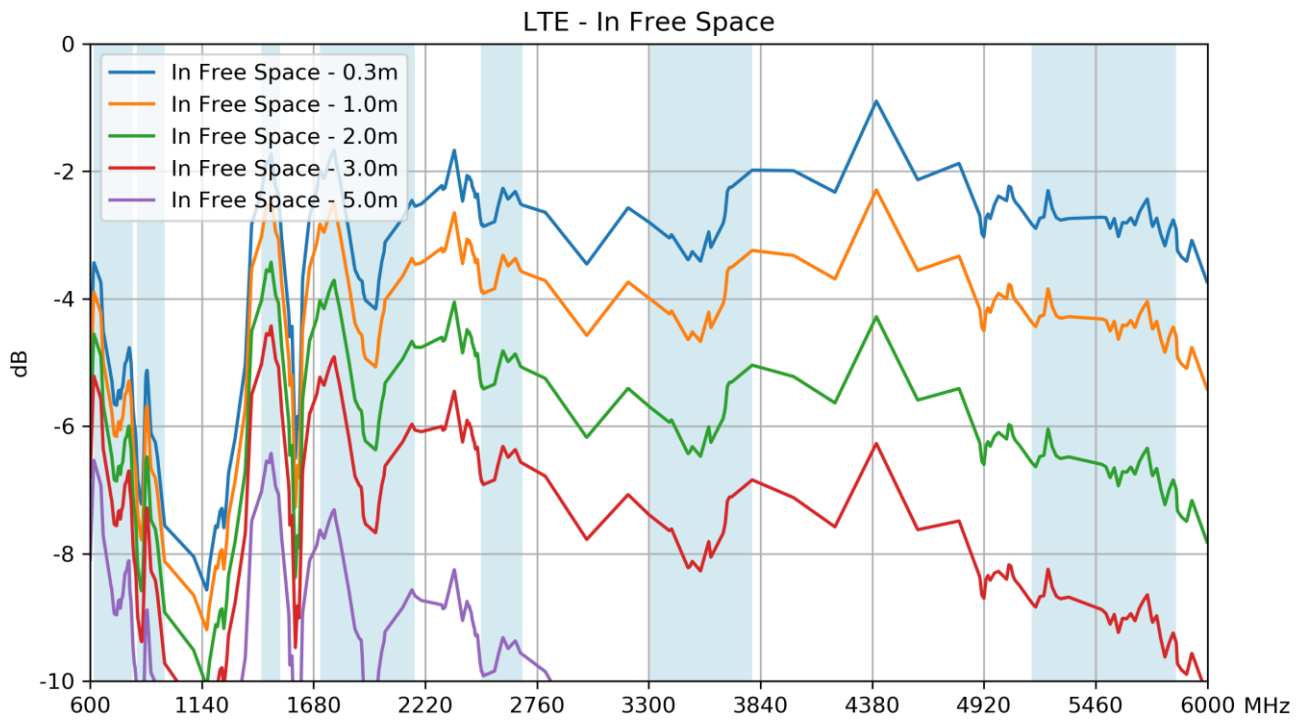

Wi-Fi

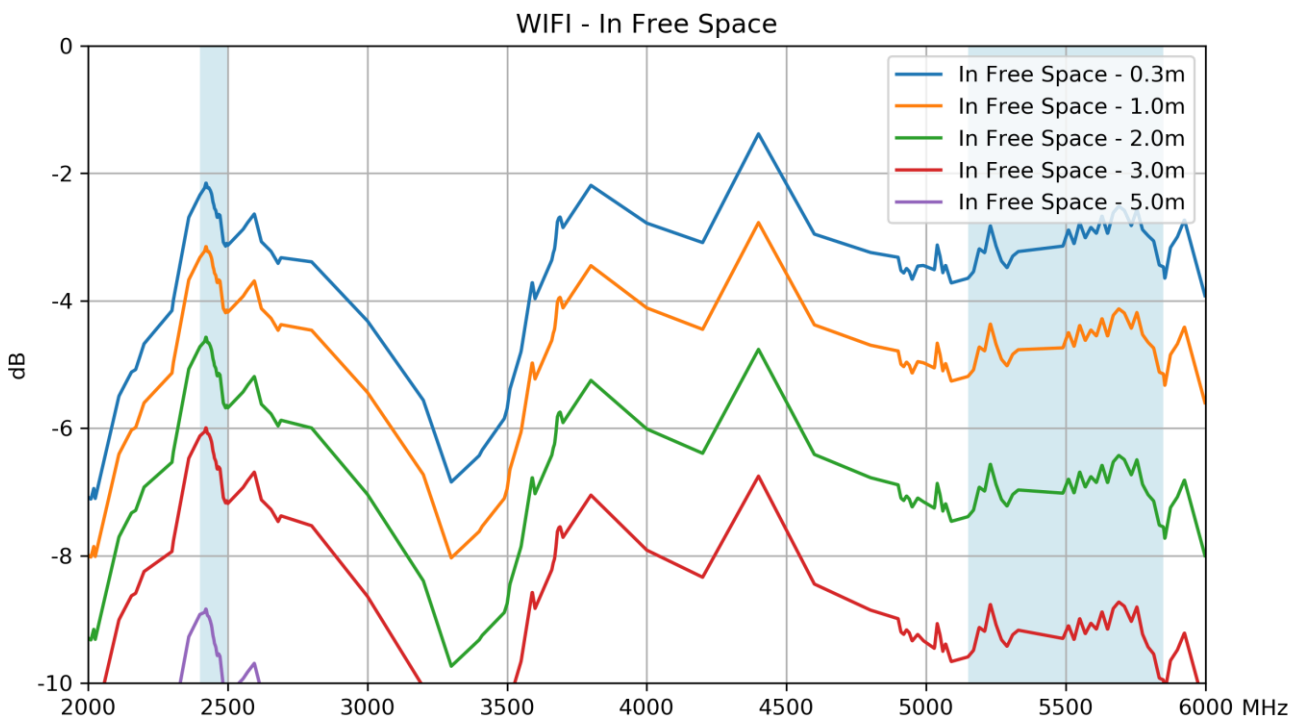

8.4 Peak Gain In Free Space

LTE

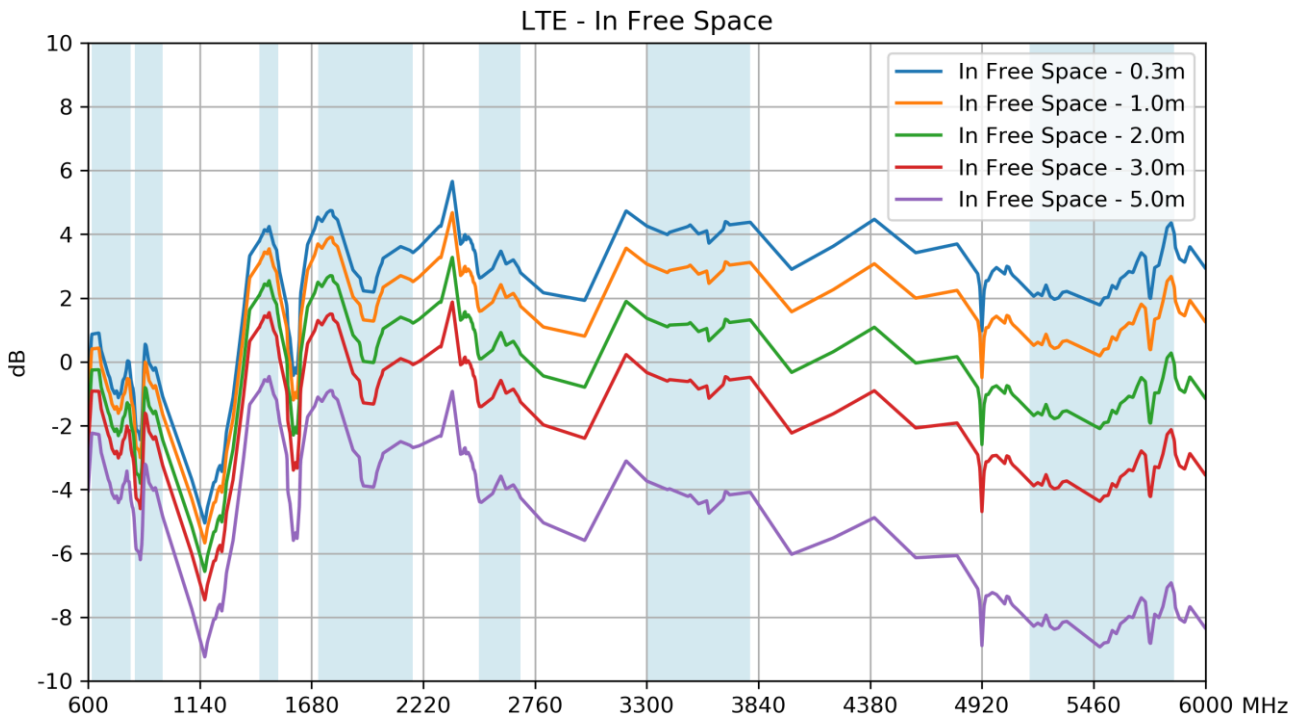

Wi-Fi

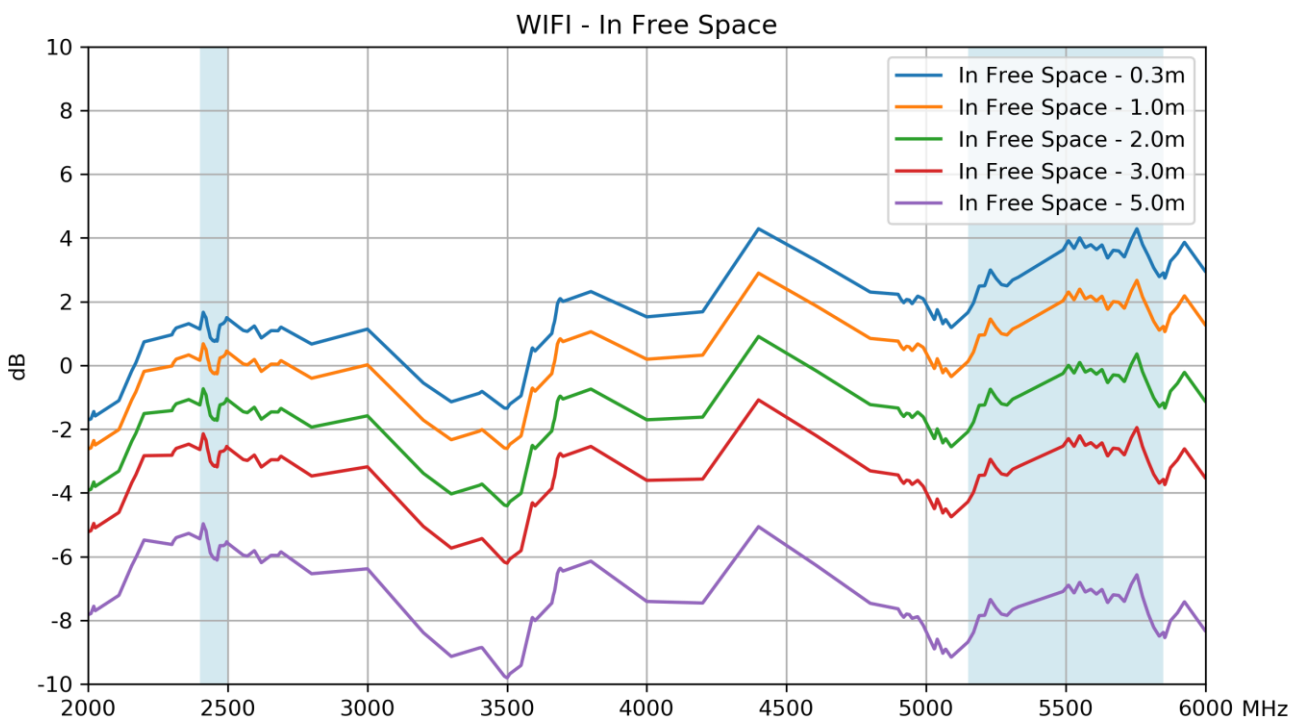

8.5 Return Loss On 30x30cm Ground Plane

LTE

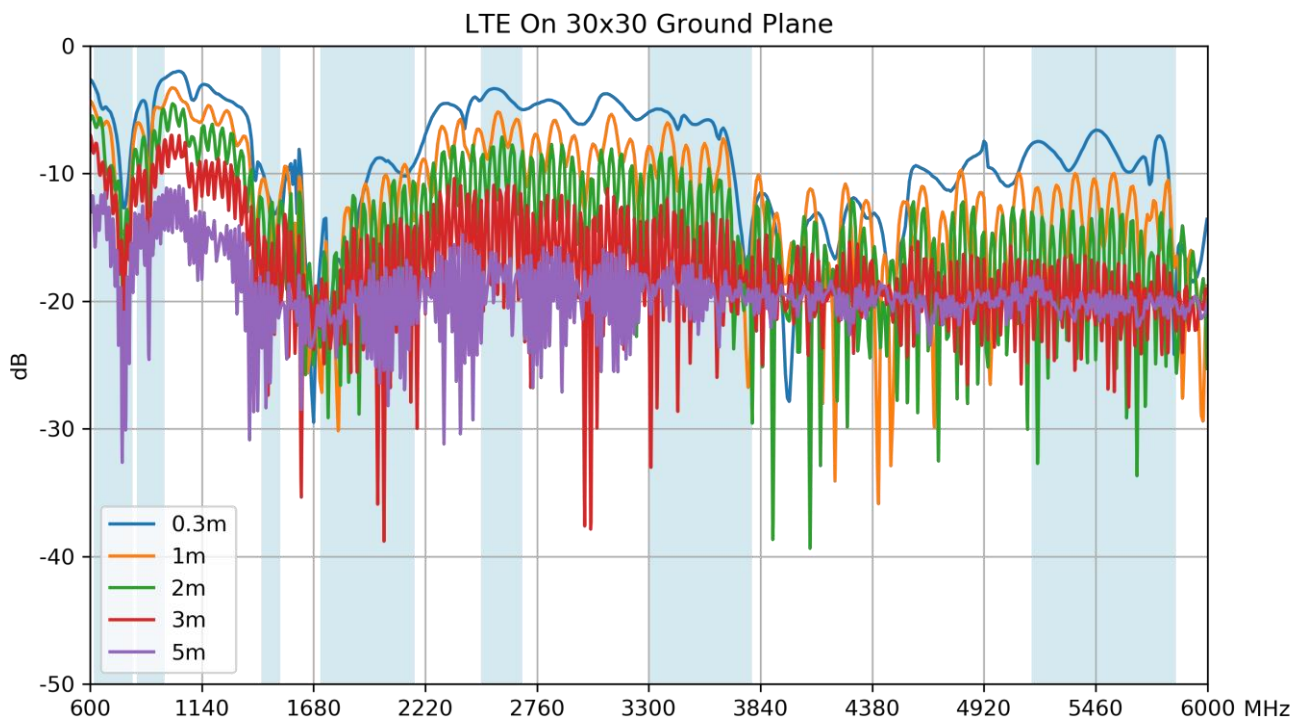

Wi-Fi

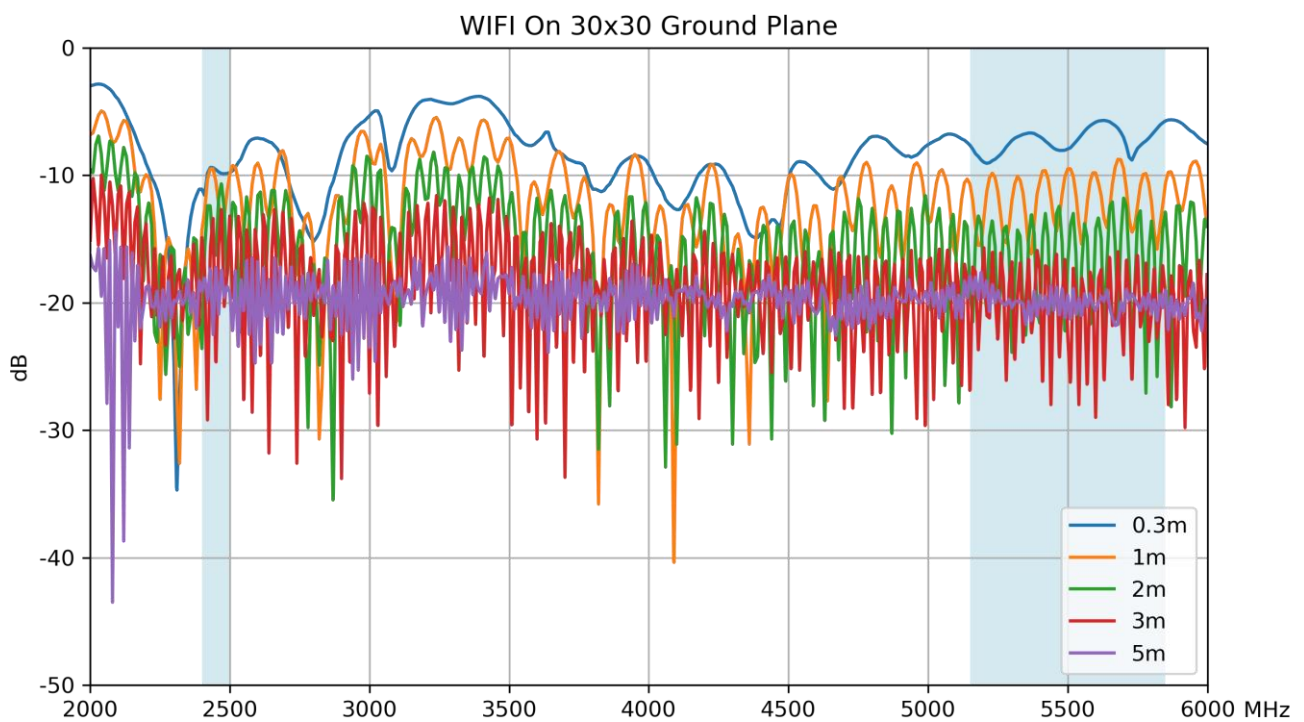

8.6 Efficiency On 30x30 Ground Plane

LTE

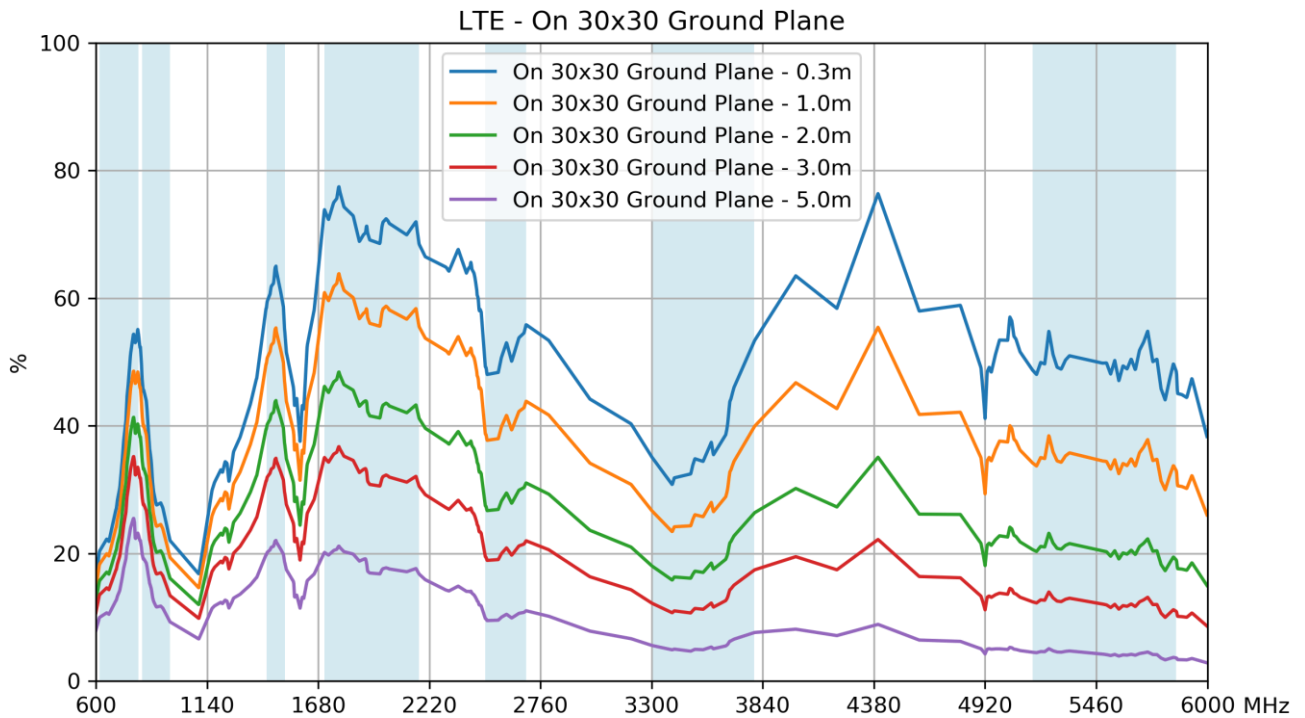

Wi-Fi

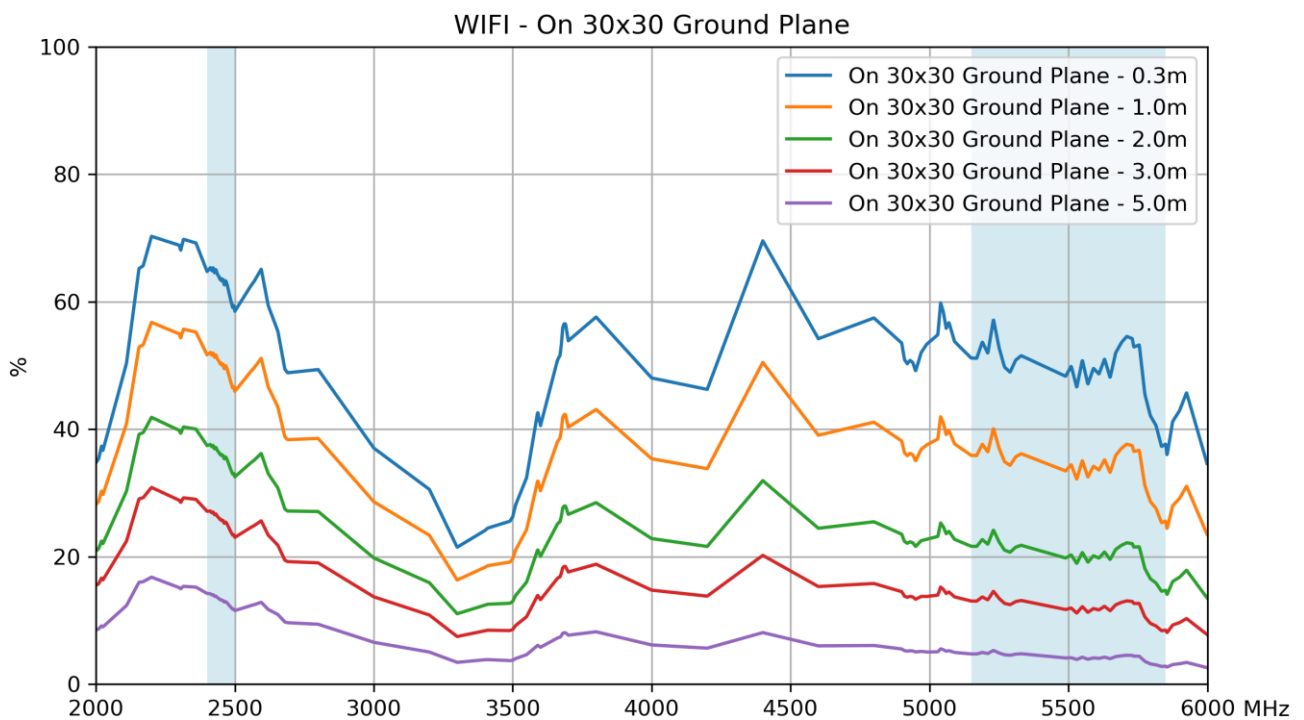

8.7 Average Gain On 30x30 Ground Plane

LTE

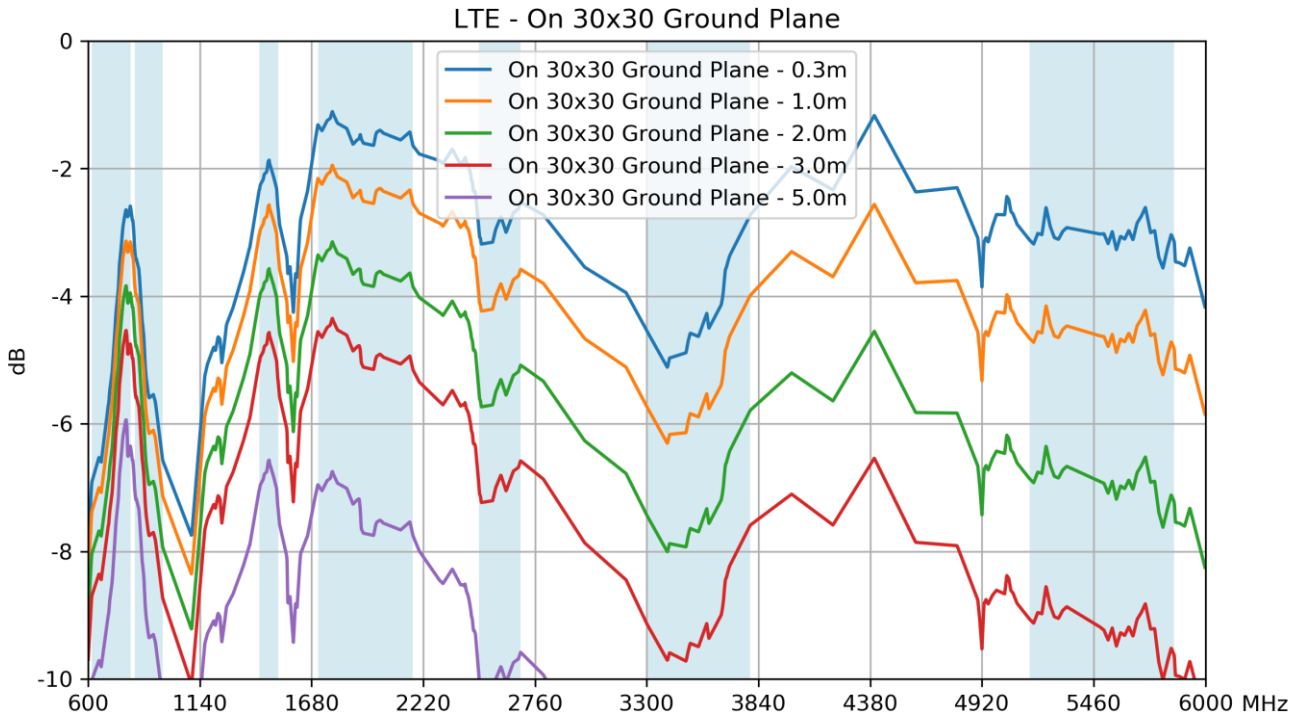

Wi-Fi

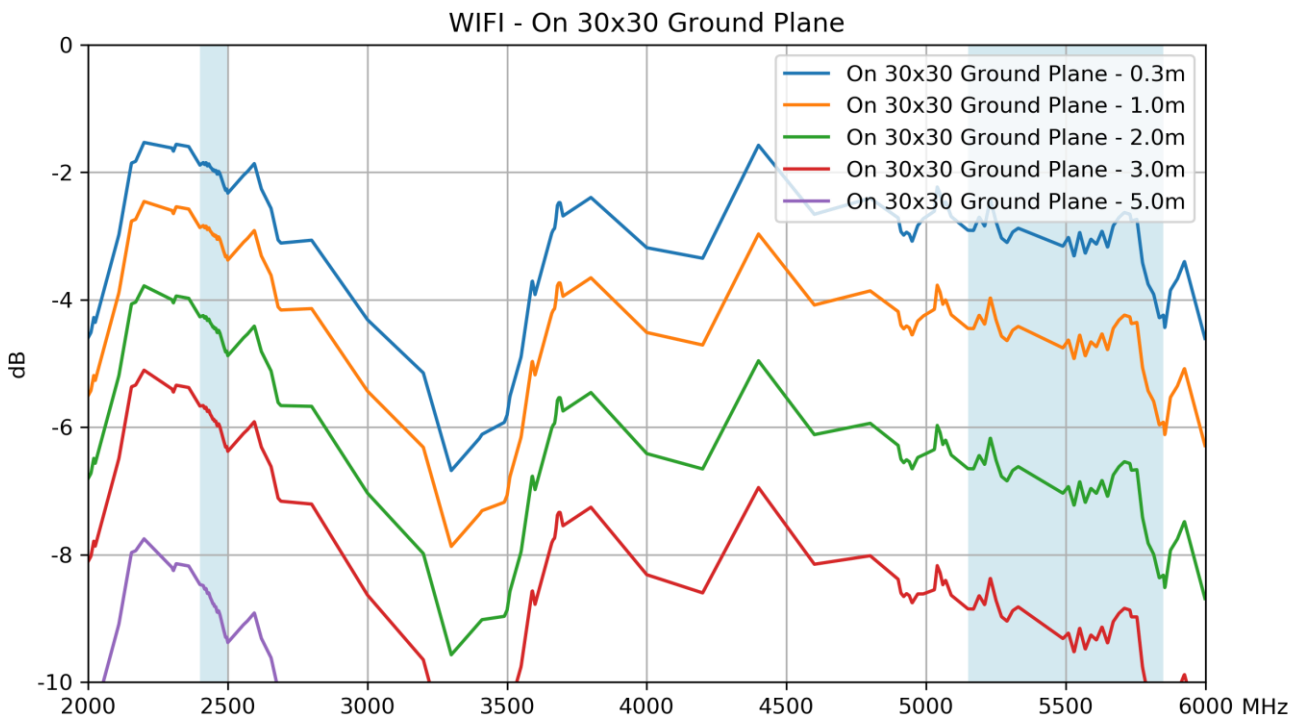

8.8 Peak Gain On 30x30 Ground Plane

LTE

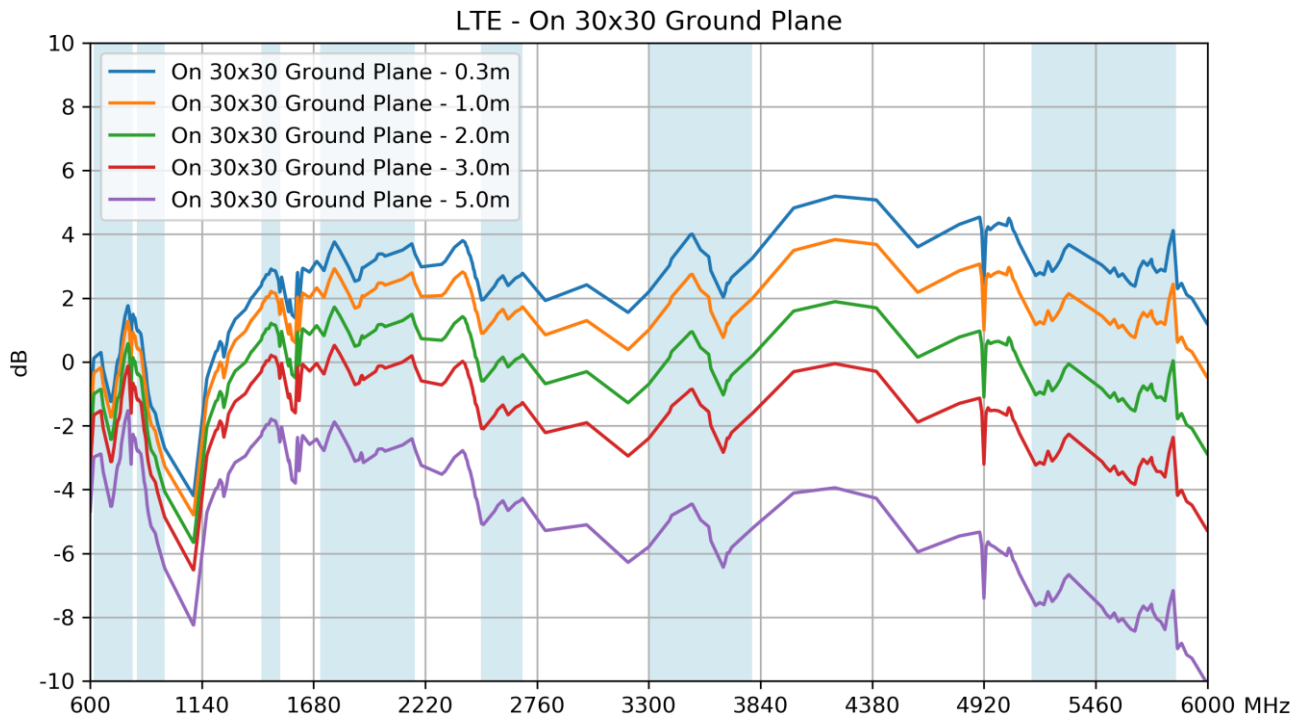

Wi-Fi

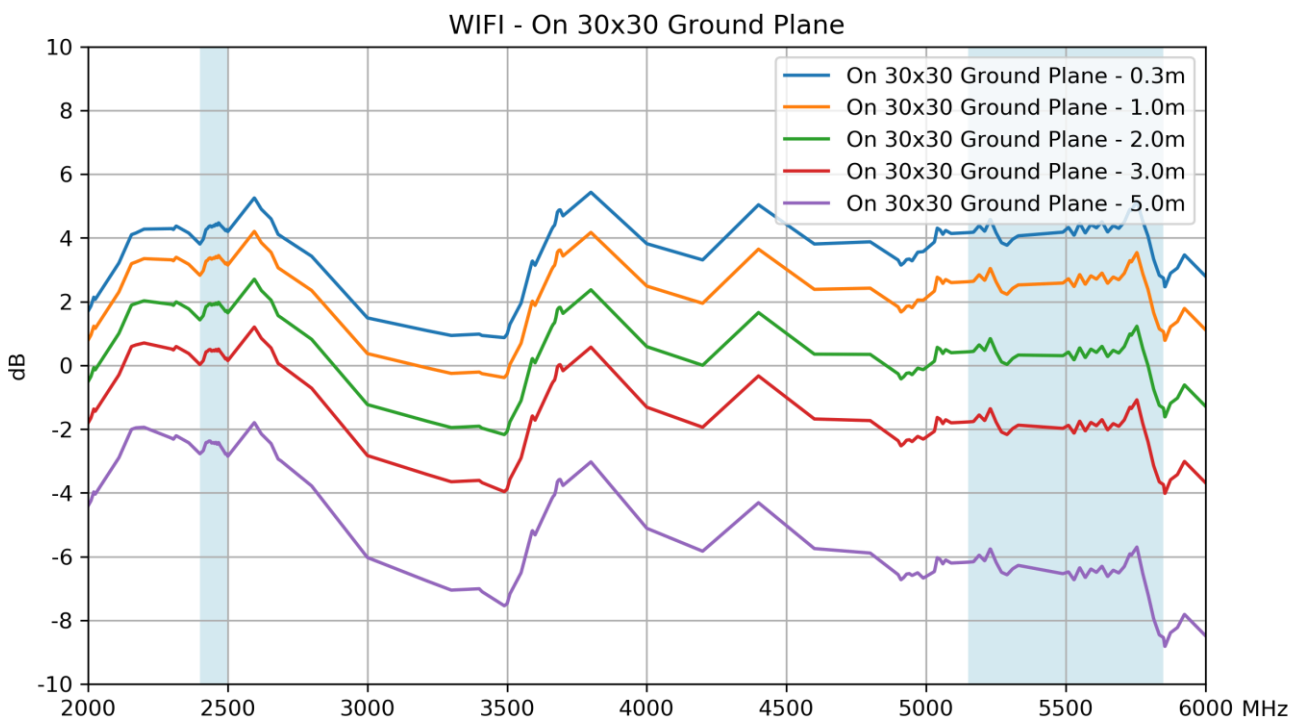

8.9 Cellular Data

Free Space										
Frequency (MHz)	5G NR Band 71	LTE700	GSM850/900	5G NR Band 74, 75, 76	DCS	PCS	UMTS1	LTE2600	5G NR Band 77, 78, 79	LTE5200/Wi-Fi5800
	617 ~698	698 ~806	824 ~960	1427 ~1518	1710 ~1880	1850 ~1990	1920 ~2170	2490 ~2690	3300 ~3500	5150 ~5925
Efficiency (%)										
0.3m	N/A	29.78	23.25	62.01	60.81	42.38	46.23	55.02	48.87	N/A
1m	N/A	26.46	20.25	52.77	49.87	34.92	37.56	43.21	36.90	N/A
2m	N/A	22.15	16.73	40.74	37.69	26.01	27.74	30.80	24.61	N/A
3m	N/A	18.49	13.77	31.62	28.59	19.45	20.57	21.85	16.57	N/A
5m	N/A	15.44	11.34	24.55	21.69	14.54	15.25	15.50	11.15	N/A
Average Gain (dB)										
0.3m	N/A	-5.26	-6.34	-2.08	-2.16	-3.73	-3.35	-2.59	-3.11	N/A
1m	N/A	-5.77	-6.94	-2.78	-3.02	-4.57	-4.25	-3.64	-4.33	N/A
2m	N/A	-6.55	-7.76	-3.90	-4.24	-5.85	-5.57	-5.12	-6.09	N/A
3m	N/A	-7.33	-8.61	-5.00	-5.44	-7.11	-6.87	-6.61	-7.81	N/A
5m	N/A	-8.11	-9.45	-6.10	-6.64	-8.37	-8.17	-8.10	-9.53	N/A
Peak Gain (dBi)										
0.3m	N/A	0.04	0.56	4.25	4.74	3.51	3.61	3.48	4.26	N/A
1m	N/A	-0.52	-0.04	3.55	3.84	2.71	2.71	2.38	3.06	N/A
2m	N/A	-1.26	-0.84	2.45	2.64	1.41	1.31	0.88	1.36	N/A
3m	N/A	-2.06	-1.74	1.35	1.44	0.21	0.01	-0.62	-0.34	N/A
5m	N/A	-2.86	-2.64	0.25	0.24	-0.99	-1.29	-2.12	-2.04	N/A

30x30 Ground Plane										
Frequency (MHz)	5G NR Band 71	LTE700	GSM850/900	5G NR Band 74, 75, 76	DCS	PCS	UMTS1	LTE2600	5G NR Band 77, 78, 79	LTE5200/Wi-Fi5800
	617 ~698	698 ~806	824 ~960	1427 ~1518	1710 ~1880	1850 ~1990	1920 ~2170	2490 ~2690	3300 ~3800	5150 ~5925
Efficiency (%)										
0.3m	N/A	43.17	35.45	60.82	73.58	70.29	70.75	51.39	33.14	N/A
1m	N/A	38.33	30.87	51.77	60.34	57.87	57.50	40.37	25.02	N/A
2m	N/A	32.07	25.55	39.96	45.57	43.12	42.54	28.77	16.69	N/A
3m	N/A	26.76	21.07	31.02	34.56	32.21	31.53	20.41	11.23	N/A
5m	N/A	22.34	17.37	24.08	26.22	24.07	23.38	14.48	7.56	N/A
Average Gain (dB)										
0.3m	N/A	-3.65	-4.50	-2.16	-1.33	-1.53	-1.50	-2.89	-4.80	N/A
1m	N/A	-4.16	-5.10	-2.86	-2.19	-2.38	-2.40	-3.94	-6.02	N/A
2m	N/A	-4.94	-5.93	-3.98	-3.41	-3.65	-3.71	-5.41	-7.78	N/A
3m	N/A	-5.72	-6.76	-5.08	-4.61	-4.92	-5.01	-6.90	-9.50	N/A
5m	N/A	-6.51	-7.60	-6.18	-5.81	-6.19	-6.31	-8.39	-11.22	N/A
Peak Gain (dBi)										
0.3m	N/A	1.79	1.04	2.91	3.76	3.36	3.70	2.78	3.98	N/A
1m	N/A	1.29	0.44	2.21	2.86	2.46	2.80	1.78	2.69	N/A
2m	N/A	0.49	-0.36	1.11	1.66	1.16	1.40	0.28	0.98	N/A
3m	N/A	-0.31	-1.16	0.01	0.46	-0.14	0.10	-1.30	-0.81	N/A
5m	N/A	-1.11	-1.96	-1.09	-0.74	-1.44	-1.20	-2.80	-2.51	N/A

8.10 Wi-Fi Data

Free Space		
Frequency (MHz)	2400~2500	5150~5850
Efficiency (%)		
0.3m	55.98	50.07
1m	44.44	34.91
2m	31.70	21.06
3m	22.72	12.53
5m	11.76	4.52
Average Gain (dB)		
0.3m	-2.52	-3.00
1m	-3.52	-4.57
2m	-4.99	-6.77
3m	-6.44	-9.02
5m	-9.29	-13.45
Peak Gain (dBi)		
0.3m	1.67	4.29
1m	0.67	2.69
2m	-0.73	0.39
3m	-2.23	-1.89
5m	-5.03	-6.29

30x30 Ground Plane		
Frequency (MHz)	2400~2500	5150~5850
Efficiency (%)		
0.3m	63.67	49.49
1m	50.51	34.54
2m	36.03	20.85
3m	25.82	12.42
5m	13.37	4.49
Average Gain (dB)		
0.3m	-1.96	-3.06
1m	-2.97	-4.62
2m	-4.43	-6.81
3m	-5.88	-9.06
5m	-8.74	-13.48
Peak Gain (dBi)		
0.3m	4.48	5.16
1m	3.48	3.56
2m	1.98	1.26
3m	0.58	-1.04
5m	-2.32	-5.51

Changelog for the datasheet

SPE-20-8-021 – MA145.A.LBC.001

Revision: A (Original Version)

Date:	2020-03-10
Changes:	Initial Release
Changes Made by:	Jack Conroy

Previous Revisions



TAOGLAS®

www.taoglas.com



X-ON Electronics

Largest Supplier of Electrical and Electronic Components

Click to view similar products for [Antennas](#) category:

Click to view products by [Taoglas](#) manufacturer:

Other Similar products are found below :

[GAN30084EU](#) [930-033-R](#) [GW17.07.0250E](#) [1513563-1](#) [EXE902SM](#) [APAMPG-117](#) [MAF94383](#) [W3908B0100](#) [W6102B0100](#) [YE572113-30RSMM](#) [108-00014-50](#) [66089-2406](#) [A09-F8NF-M](#) [A09-F5NF-M](#) [RGFRA1903041A1T](#) [W3593B0100](#) [W3921B0100](#) [SIMNA-868](#) [SIMNA-915](#) [SIMNA-433](#) [W1044](#) [W1049B090](#) [A75-001](#) [WTL2449CQ1-FRSMM](#) [CPL9C](#) [EXB148BN](#) [0600-00060](#) [TRA9020S3PBN-001](#) [GD5W-28P-NF](#) [MA9-7N](#) [GD53-25](#) [GD5W-21P-NF](#) [C37](#) [MAF94051](#) [MA9-5N](#) [EXD420PL](#) [B1322NR](#) [QWFTB120](#) [MAF94271](#) [MAF94300](#) [GPSMB301](#) [FG4403](#) [AO-AGSM-OM54](#) [5200232](#) [MIKROE-2349](#) [WCM.01.0111](#) [MIKROE-2393](#) [MIKROE-2352](#) [MIKROE-2350](#) [MAF94153](#)