

Specification

- Part No. : **MA241.BI.001**
- Product Name : MA241 **Genesis** LTE MIMO 2in1
Adhesive Mount Combination Antenna
2* 4G MIMO LTE 698 to 896/1710 to 2700MHz
Supports 3G Fall-back
- Features : IP65 Antenna
2 * LTE: 2 meter Low Loss NFC-200 SMA(M)ST
Dimensions: 205.8 x 68 x 12.4mm
RoHS Compliant



1. Introduction

The MA241 Genesis antenna is an omni-directional, fully IP65 waterproof external M2M antenna for use in telematics, transportation and remote monitoring applications. It is designed to be mounted directly on glass or plastic in the interior of vehicles.

Typical applications

- HD Video over LTE
- First Responder and Emergency Services

This unique antenna delivers powerful MIMO antenna technology for worldwide 4G LTE bands at 700MHz/800MHz/1700MHz/1800MHz/2600MHz. It enables designers to use only one antenna that covers all common frequencies for LTE and 4G globally.

4G wireless applications demand high speed data uplink and downlink. High efficiency and high gain MIMO antennas are necessary to achieve the required signal to noise ratio and throughput required to solve these challenges. Taoglas also takes care to have high isolation between the two MIMO antennas to prevent self-interference. Low loss cables are used to keep efficiency high over long cable lengths. In contrast, smaller MIMO antennas with poorer quality thinner cables will have much reduced efficiency and isolation, which would lead to a large drop in system throughput or drops, and may indeed not make a system connection at all.

Cable length and connector types are customizable. [Contact](#) your regional Taoglas sales office for support.

2. Specification

4G/3G MIMO1 Antenna									
Frequency (MHz)		698 ~803	824 ~894	880 ~960	1710 ~1880	1850 ~1990	1920 ~2170	2490 ~2690	3410 ~3490
Efficiency (%)									
In free space	30cm	72.01	45.99	34.09	73.58	68.59	33.44	63.58	38.76
	1M	70.55	56.19	39.21	66.54	52.25	45.40	59.01	33.16
	2M	64.18	42.21	29.69	60.55	33.71	27.32	50.17	29.20
	3M	59.38	37.78	27.57	53.47	29.71	23.89	42.78	24.46
	5M	51.25	31.84	23.14	41.89	22.94	18.50	32.70	17.59
On the 2mm ABS base	30cm	65.93	36.48	26.86	60.26	38.12	30.54	56.90	32.33
	1M	71.92	52.85	31.51	62.46	48.02	42.26	59.79	34.38
	2M	58.76	34.28	23.40	49.55	31.05	24.95	44.87	24.37
	3M	56.15	31.80	21.72	44.39	29.14	22.18	38.32	20.40
	5M	46.95	25.27	18.25	34.28	21.13	16.89	29.24	14.68
On the glass base	30cm	43.02	18.05	11.86	37.76	27.71	27.15	58.38	30.74
	1M	49.79	15.28	8.64	38.20	35.24	37.66	63.96	32.37
	2M	38.34	17.81	10.33	31.05	22.58	22.19	46.02	23.13
	3M	36.20	16.54	9.59	27.82	20.43	18.90	39.31	18.78
	5M	30.66	12.52	8.06	21.48	15.35	15.02	29.99	13.94
Average Gain(dBi)									
In free space	30cm	-1.46	-3.39	-4.75	-1.44	-1.67	-4.84	-1.98	-4.45
	1M	-1.52	-2.53	-4.23	-1.82	-2.84	-3.49	-2.31	-4.98
	2M	-1.96	-3.76	-5.35	-2.29	-4.79	-5.72	-3.01	-5.70
	3M	-2.30	-4.25	-5.68	-2.83	-5.34	-6.30	-3.70	-6.45
	5M	-2.94	-4.99	-6.43	-3.89	-6.47	-7.41	-4.87	-7.90
On the 2mm ABS base	30cm	-1.86	-4.41	-5.79	-2.24	-4.27	-5.21	-2.46	-5.34
	1M	-1.44	-2.83	-5.26	-2.10	-3.21	-3.79	-2.25	-4.80
	2M	-2.36	-4.67	-6.39	-3.10	-5.16	-6.09	-3.49	-6.59
	3M	-2.54	-5.00	-6.72	-3.57	-5.45	-6.61	-4.18	-7.34
	5M	-3.34	-6.01	-7.47	-4.70	-6.84	-7.78	-5.35	-8.79
On the glass base	30cm	-3.76	-7.54	-9.36	-4.28	-5.59	-5.70	-2.35	-5.32
	1M	-3.12	-8.39	-10.74	-4.24	-4.55	-4.27	-1.95	-4.90
	2M	-4.26	-7.59	-9.96	-5.13	-6.48	-6.58	-3.38	-6.57
	3M	-4.51	-7.92	-10.29	-5.61	-6.92	-7.25	-4.07	-7.53
	5M	-5.24	-9.14	-11.05	-6.73	-8.16	-8.27	-5.24	-8.77

		Peak Gain(dBi)							
In free space	30cm	3.61	1.20	-0.05	3.31	3.41	-0.63	3.01	0.43
	1M	2.84	2.15	0.02	2.61	1.74	1.08	3.26	-0.68
	2M	3.11	0.98	-0.65	2.46	-0.33	-1.50	1.98	-0.82
	3M	2.78	0.35	-0.98	1.92	-0.89	-2.09	1.28	-1.57
	5M	2.14	-0.40	-1.74	0.86	-2.01	-3.19	0.12	-3.02
On the 2mm ABS base	30cm	3.09	-0.25	-0.95	2.34	0.42	-0.30	2.97	-0.92
	1M	2.30	2.38	-0.13	2.12	1.09	0.81	3.11	-0.32
	2M	2.59	-0.57	-1.55	1.49	-0.47	-1.17	1.94	-2.17
	3M	2.49	-0.90	-1.88	1.08	-0.77	-1.79	1.26	-2.92
	5M	1.62	-1.85	-2.64	-0.11	-2.15	-2.87	0.08	-4.37
On the glass base	30cm	1.04	-3.36	-5.33	0.57	-0.37	0.31	3.15	0.82
	1M	0.78	-3.92	-6.55	1.42	0.67	1.21	4.22	1.80
	2M	0.54	-3.22	-5.93	0.99	-1.26	-0.57	2.12	-0.43
	3M	0.27	-3.55	-6.25	-0.72	-1.76	-1.37	1.43	-0.97
	5M	-0.43	-4.96	-7.01	-1.89	-2.94	-2.26	0.26	-2.63

4G/3G MIMO2 Antenna

Frequency (MHz)		698~803	824~894	880~960	1710 ~1880	1850 ~1990	1920 ~2170	2490 ~2690	3410 ~3490
Efficiency (%)									
In free space	30cm	58.24	56.13	53.67	76.47	68.59	62.96	74.88	56.10
	1M	64.65	57.39	48.73	62.52	53.06	48.63	50.84	30.29
	2M	51.90	46.53	46.74	62.79	55.87	51.48	59.06	42.12
	3M	47.88	45.93	43.42	55.53	49.19	45.01	50.66	35.40
	5M	41.47	38.78	36.45	43.44	38.00	34.87	38.49	25.38
On the 2mm ABS base	30cm	63.50	33.06	39.97	69.58	59.05	54.39	61.78	39.33
	1M	73.97	51.78	44.03	63.30	48.55	46.18	52.15	27.82
	2M	56.60	29.34	34.82	57.11	48.11	44.46	48.71	29.50
	3M	53.49	27.18	32.32	50.22	44.24	38.88	41.62	30.25
	5M	45.23	22.87	27.09	39.51	32.73	30.11	31.75	17.78
On the glass base	30cm	66.98	26.43	29.96	63.52	59.22	60.07	71.14	38.27
	1M	52.66	47.32	35.07	53.47	52.02	50.64	64.75	29.52
	2M	59.70	23.27	26.09	52.25	48.25	49.10	56.09	28.70
	3M	57.47	21.58	23.80	46.05	42.08	42.68	47.91	26.90
	5M	47.72	18.28	20.30	36.15	32.78	33.26	36.55	17.29
Average Gain(dBi)									
In free space	30cm	-2.37	-2.71	-2.88	-1.17	-1.67	-2.04	-1.27	-2.53
	1M	-1.92	-2.46	-3.24	-2.05	-2.83	-3.19	-2.96	-5.19
	2M	-2.87	-3.52	-3.48	-2.03	-2.55	-2.91	-2.30	-3.78
	3M	-3.22	-3.56	-3.81	-2.56	-3.11	-3.50	-2.97	-4.53
	5M	-3.85	-4.31	-4.56	-3.63	-4.23	-4.61	-4.16	-5.98
On the 2mm ABS base	30cm	-2.01	-4.90	-4.04	-1.59	-2.32	-2.65	-2.10	-4.05
	1M	-1.32	-2.92	-3.62	-2.03	-3.21	-3.41	-2.85	-5.56
	2M	-2.51	-5.42	-4.64	-2.44	-3.21	-3.53	-3.13	-5.30
	3M	-2.75	-5.74	-4.97	-3.00	-3.58	-4.11	-3.82	-5.26
	5M	-3.49	-6.50	-5.73	-4.04	-4.89	-5.22	-4.99	-7.50
On the glass base	30cm	-1.88	-5.81	-5.27	-2.02	-2.29	-2.22	-1.48	-4.17
	1M	-2.95	-3.28	-4.57	-2.81	-2.87	-2.98	-1.90	-5.30
	2M	-2.38	-6.36	-5.87	-2.88	-3.18	-3.09	-2.52	-5.42
	3M	-2.51	-6.69	-6.29	-3.43	-3.78	-3.70	-3.20	-5.73
	5M	-3.36	-7.41	-6.96	-4.48	-4.86	-4.79	-4.38	-7.62

		Peak Gain(dBi)							
In free space	30cm	1.57	1.71	1.59	3.04	3.41	3.21	4.82	4.81
	1M	2.41	2.17	1.33	2.00	2.14	1.94	2.16	1.29
	2M	1.07	0.83	0.99	2.19	2.52	2.33	3.78	3.56
	3M	0.74	0.85	0.66	1.65	1.96	1.75	3.14	2.81
	5M	0.10	0.11	-0.09	0.59	0.84	0.64	1.92	1.36
On the 2mm ABS base	30cm	3.44	-0.13	0.28	2.23	2.06	2.09	2.56	2.44
	1M	2.26	0.96	0.89	1.98	2.03	2.04	2.58	0.93
	2M	2.94	-0.50	-0.32	1.38	1.17	1.22	1.53	1.19
	3M	2.75	-0.83	-0.58	0.75	0.69	0.59	0.84	1.11
	5M	1.96	-1.73	-1.41	-0.22	-0.50	-0.47	-0.33	-1.01
On the glass base	30cm	2.66	-1.47	-0.30	3.37	2.59	2.92	5.87	3.50
	1M	0.85	1.65	-0.30	1.95	2.45	2.45	4.25	-0.01
	2M	2.16	-2.19	-0.90	2.51	1.70	2.05	4.84	2.25
	3M	2.10	-2.51	-1.43	2.09	1.11	1.31	4.16	0.65
	5M	1.18	-3.07	-1.99	0.91	0.02	0.35	2.98	0.05

ELECTRICAL

Impedance	50 Ohm
VSWR	<3.5:1

MECHANICAL

Antenna Dimensions	205.8 x 68 x 12.4mm
Housing	PC+ABS Alloy
Ingress Protection Rating	IP65
Weight	210g

ENVIRONMENTAL

Operation Temperature	-40°C to 80°C
Storage Temperature	-40°C to 90°C
Humidity	Non-condensing 65°C 95% RH

LTE BANDS				
Band Number	LTE / LTE-Advanced / WCDMA / HSPA / HSPA+ / TD-SCDMA			
	Uplink	Downlink	MIMO 1	MIMO 2
1	UL: 1920 to 1980	DL: 2110 to 2170	✓	✓
2	UL: 1850 to 1910	DL: 1930 to 1990	✓	✓
3	UL: 1710 to 1785	DL: 1805 to 1880	✓	✓
4	UL: 1710 to 1755	DL: 2110 to 2155	✓	✓
5	UL: 824 to 849	DL: 869 to 894	✓	✓
7	UL: 2500 to 2570	DL: 2620 to 2690	✓	✓
8	UL: 880 to 915	DL: 925 to 960	✗	✓
9	UL: 1749.9 to 1784.9	DL: 1844.9 to 1879.9	✓	✓
11	UL: 1427.9 to 1447.9	DL: 1475.9 to 1495.9	✗	✗
12	UL: 699 to 716	DL: 729 to 746	✓	✓
13	UL: 777 to 787	DL: 746 to 756	✓	✓
14	UL: 788 to 798	DL: 758 to 768	✓	✓
17	UL: 704 to 716	DL: 734 to 746 (LTE only)	✓	✓
18	UL: 815 to 830	DL: 860 to 875 (LTE only)	✓	✓
19	UL: 830 to 845	DL: 875 to 890	✓	✓
20	UL: 832 to 862	DL: 791 to 821	✓	✓
21	UL: 1447.9 to 1462.9	DL: 1495.9 to 1510.9	✗	✗
22	UL: 3410 to 3490	DL: 3510 to 3590	✗	✗
23	UL: 2000 to 2020	DL: 2180 to 2200 (LTE only)	✗	✓
24	UL: 1625.5 to 1660.5	DL: 1525 to 1559 (LTE only)	✓	✓
25	UL: 1850 to 1915	DL: 1930 to 1995	✓	✓
26	UL: 814 to 849	DL: 859 to 894	✓	✓
27	UL: 807 to 824	DL: 852 to 869 (LTE only)	✓	✓
28	UL: 703 to 748	DL: 758 to 803 (LTE only)	✓	✓
29	UL: -	DL: 717 to 728 (LTE only)	✓	✓
30	UL: 2305 to 2315	DL: 2350 to 2360 (LTE only)	✓	✓
31	UL: 452.5 to 457.5	DL: 462.5 to 467.5 (LTE only)	✗	✗
32	UL: -	DL: 1452 - 1496	✗	✗
35		1850 to 1910	✓	✓
38		2570 to 2620	✓	✓
39		1880 to 1920	✓	✓
40		2300 to 2400	✓	✓
41		2496 to 2690	✓	✓
42		3400 to 3600	✗	✓
43		3600 to 3800	✗	✗

*Covered bands represent an efficiency greater than 20%

3. Antenna Characteristics

3.1. LTE MIMO Antenna

3.1.1. Test Setup



In free space

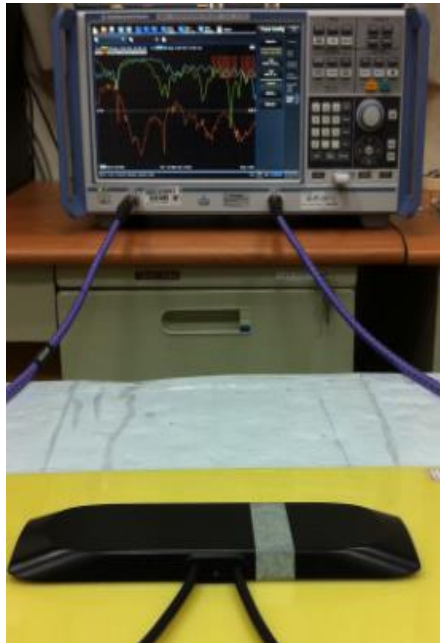

On 2mm ABS base

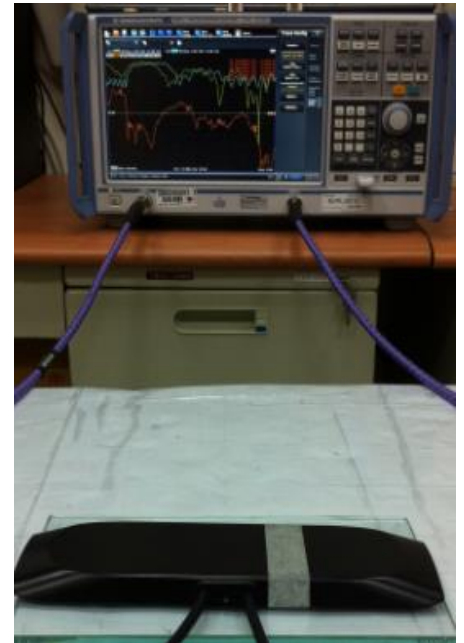

On the glass base



3.1.2. LTE Antenna Return Loss

Setup in the free space with 2 meters cable length

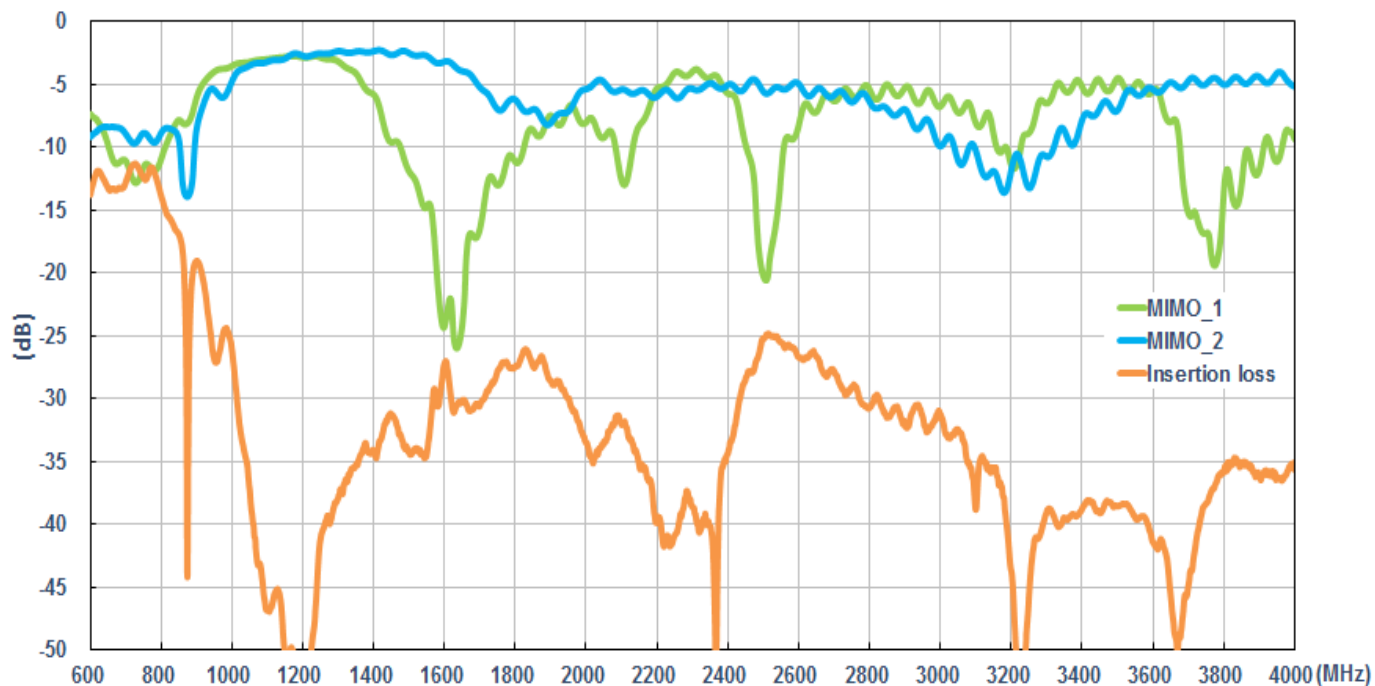

Setup on the 2mm ABS base with 2 meters cable length

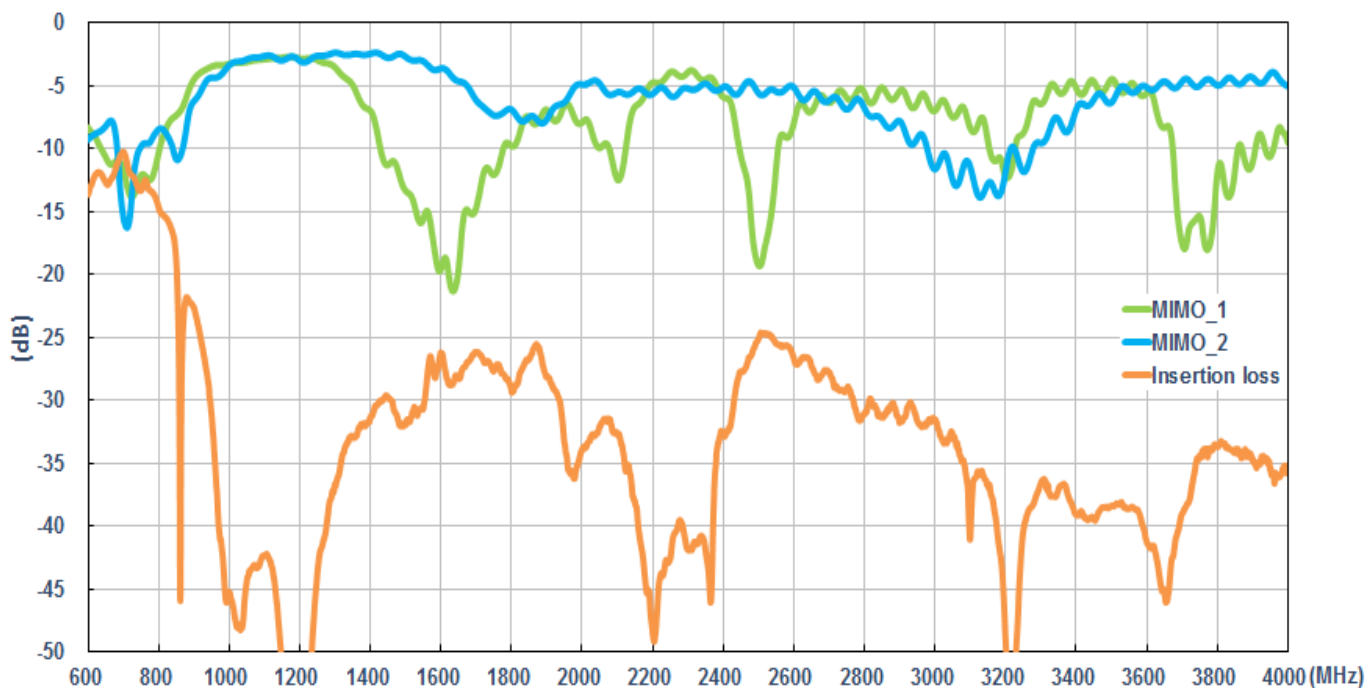



Setup on the glass base with 2 meters cable length

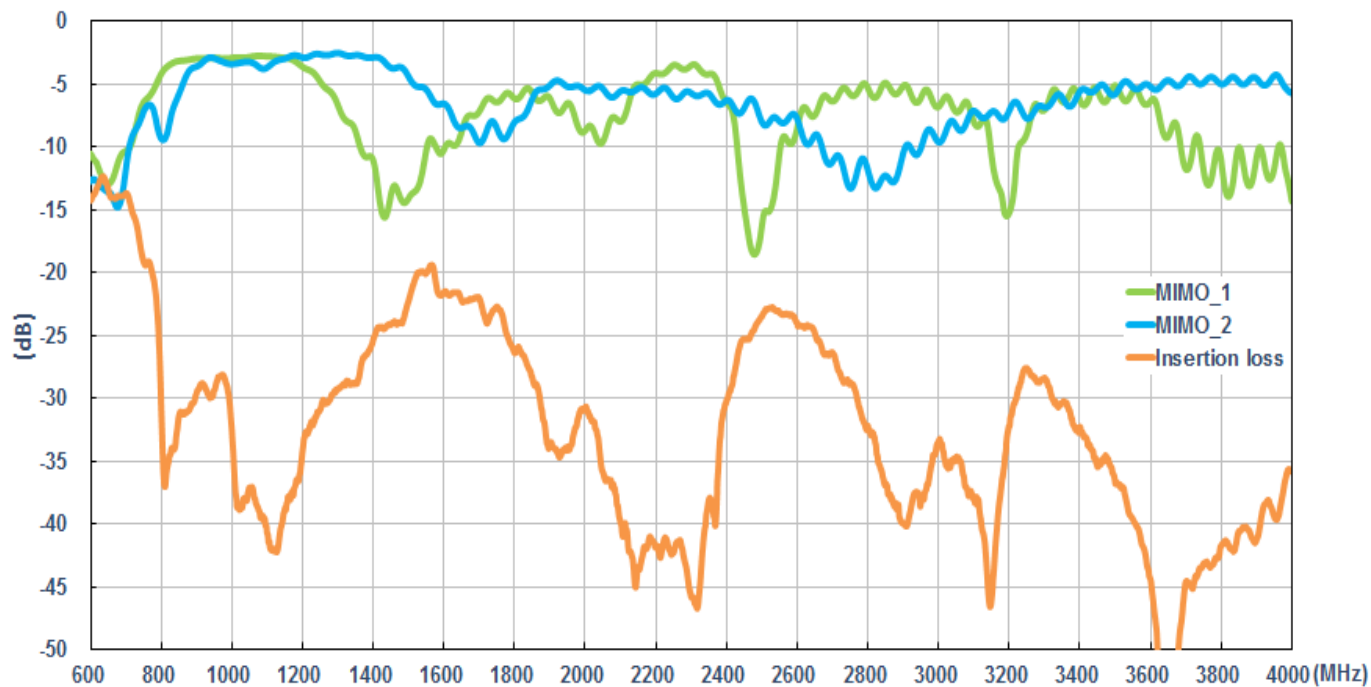



3.1.3. LTE Antenna Efficiency

MIMO 1

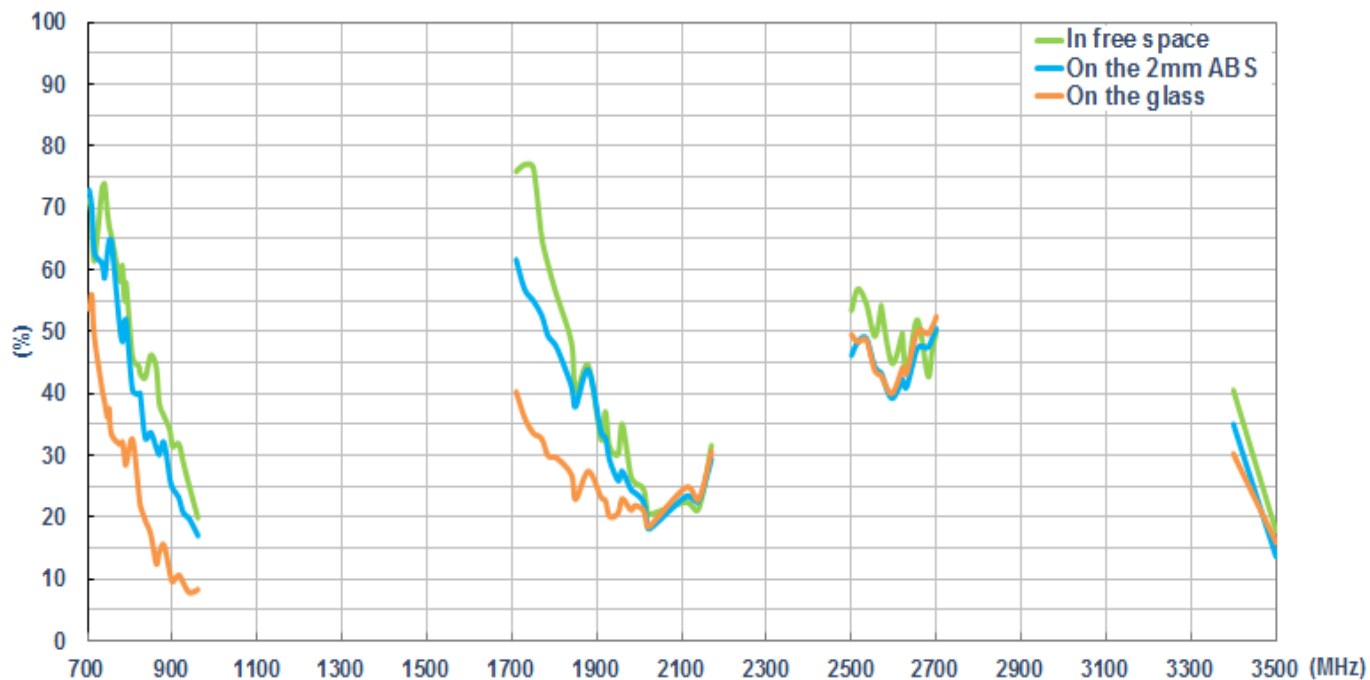

MIMO 2

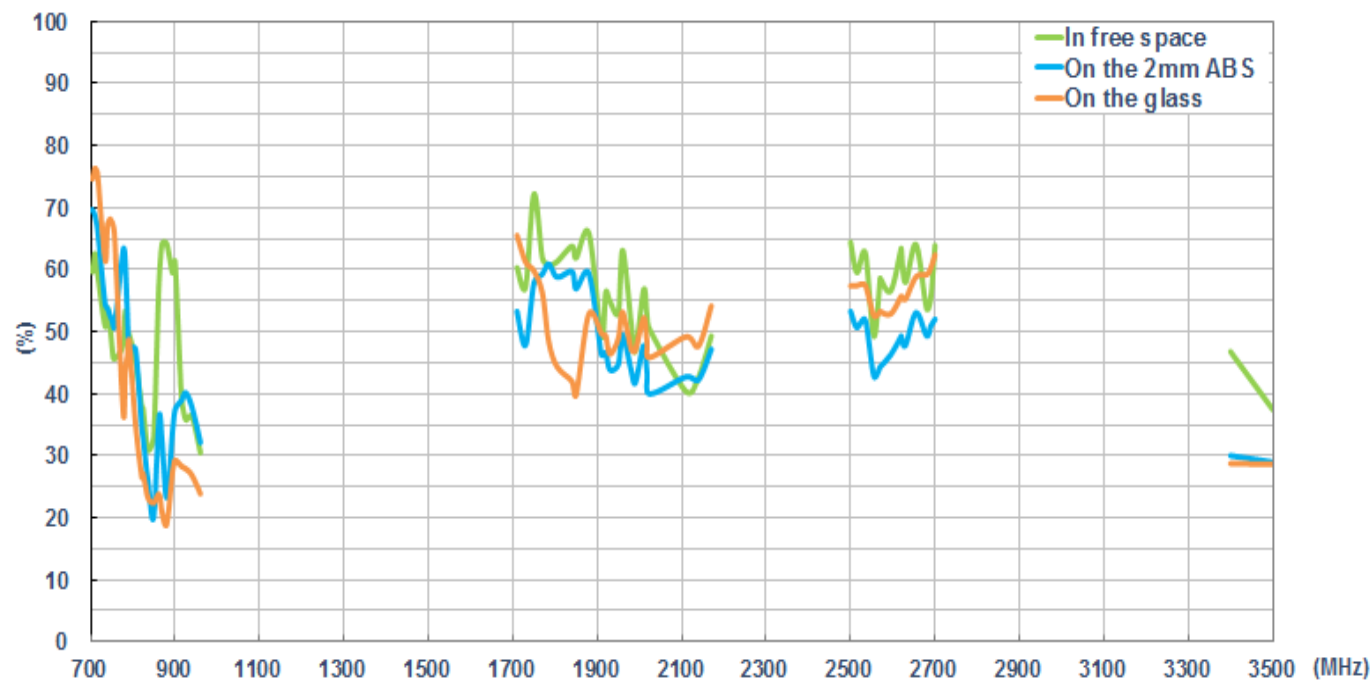



3.1.4. LTE Antenna Average Gain

MIMO 1

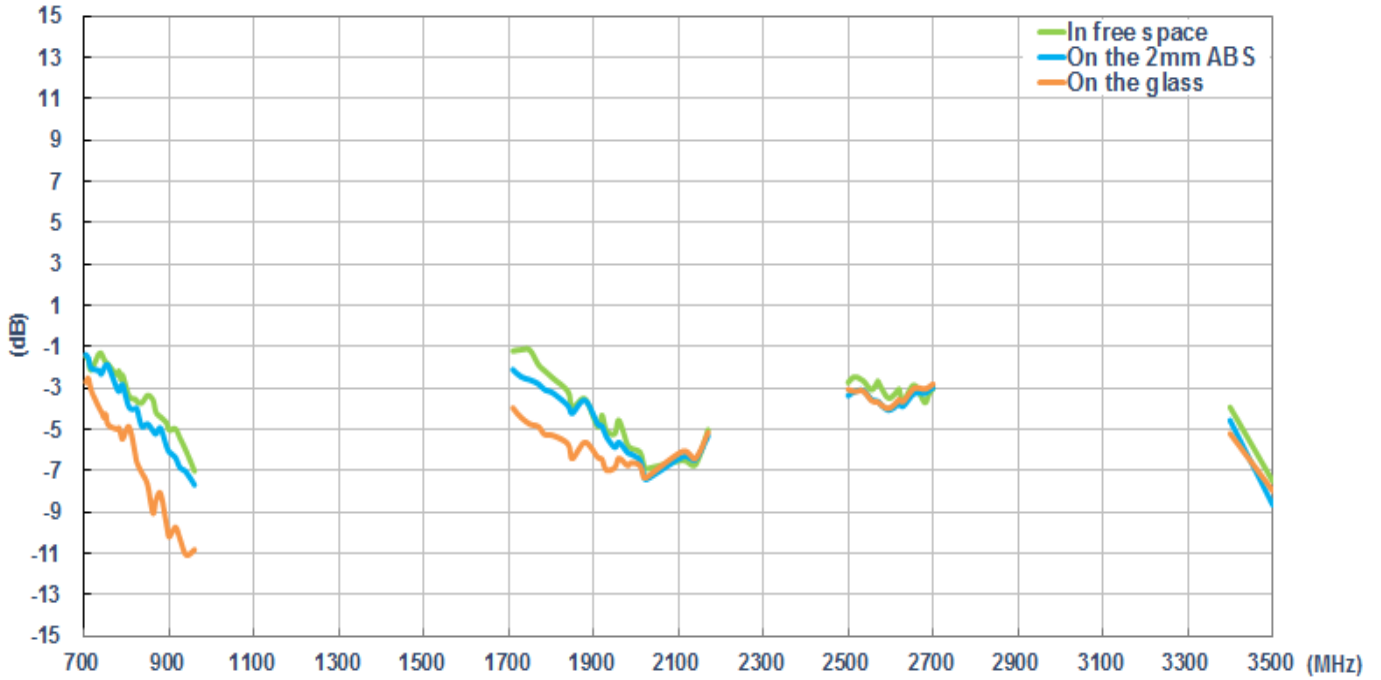

MIMO 2

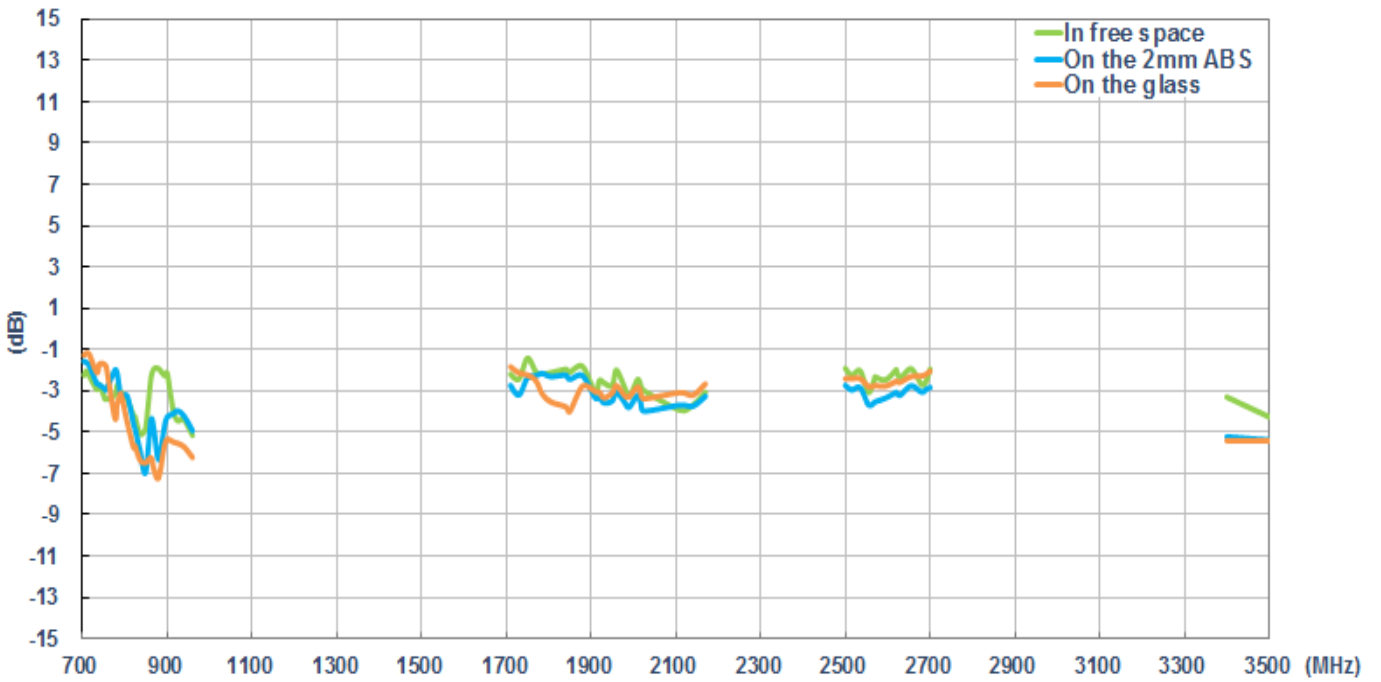



3.1.5. LTE Antenna Peak Gain

MIMO 1

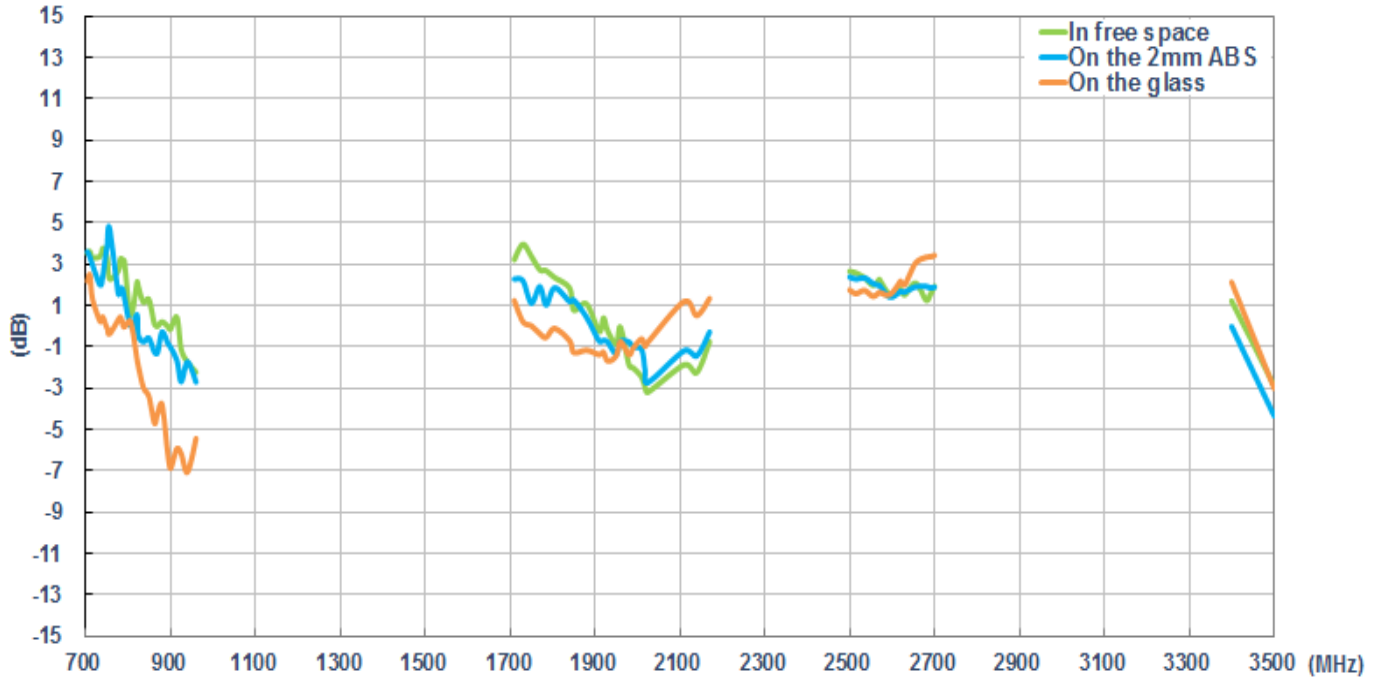

MIMO 2

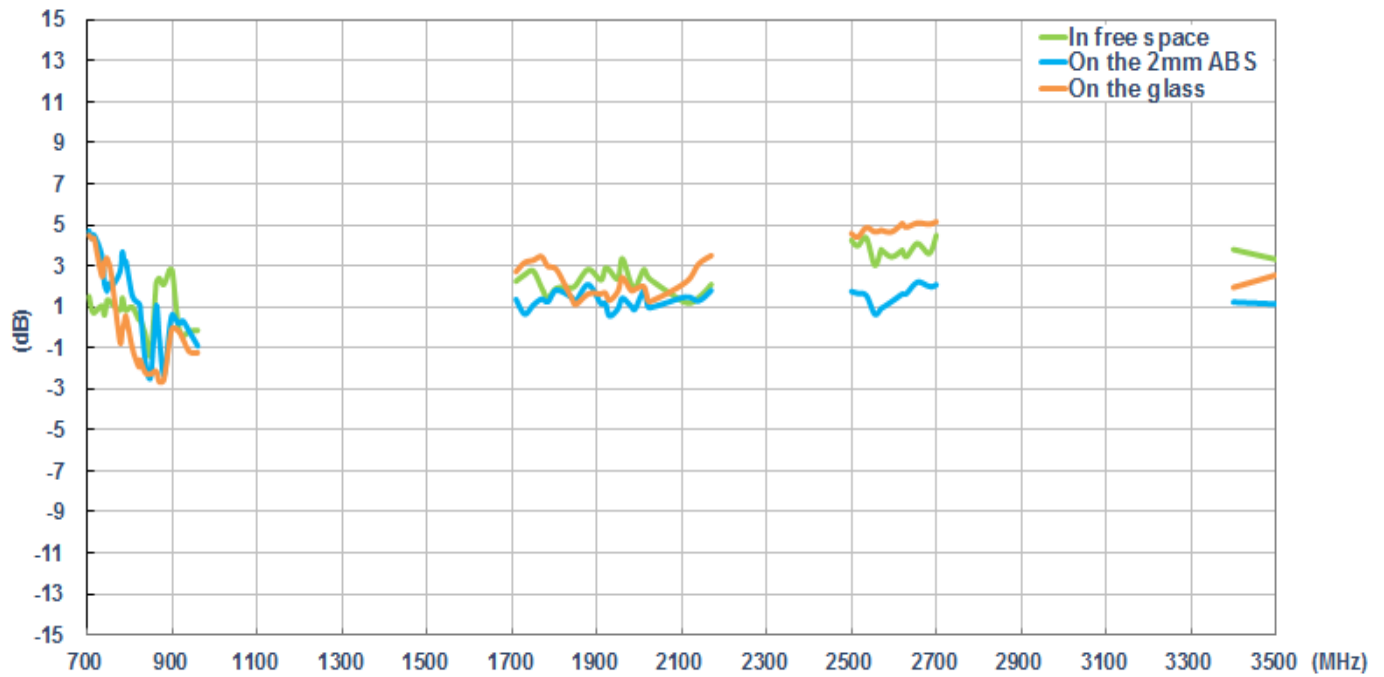

3.1.6. Test Setup for Antenna Radiation Pattern (ETS Anechoic chamber)

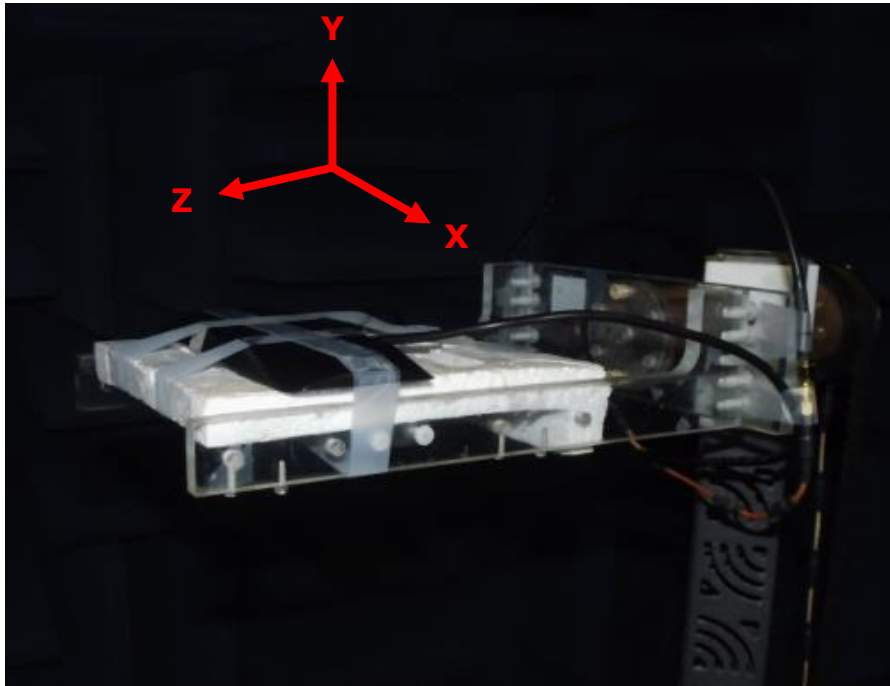

In the free space



3.1.7. 2D Radiation pattern (MIMO1 with 2M cable length in free space)

XY Plane

XZ Plane

YZ Plane

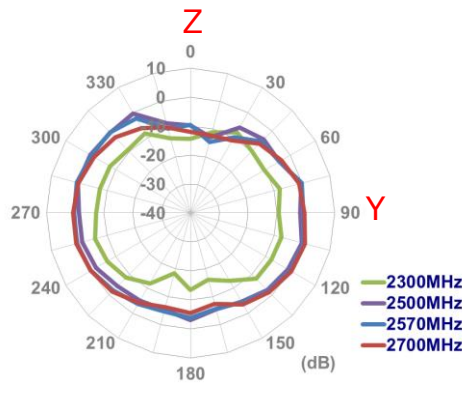
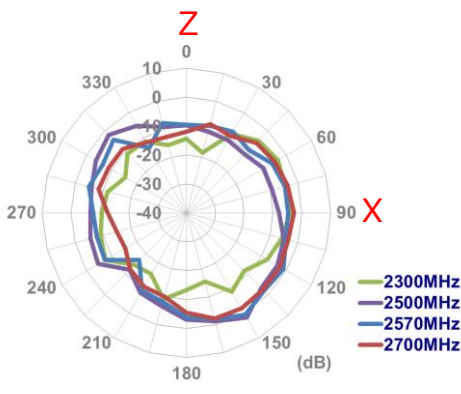
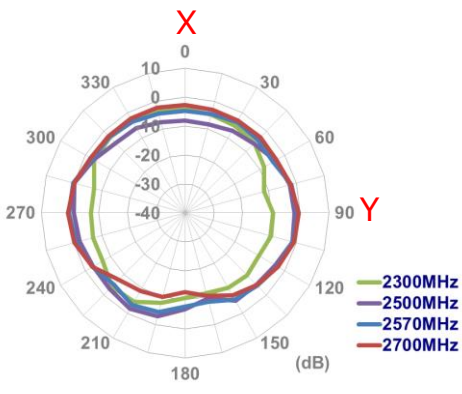
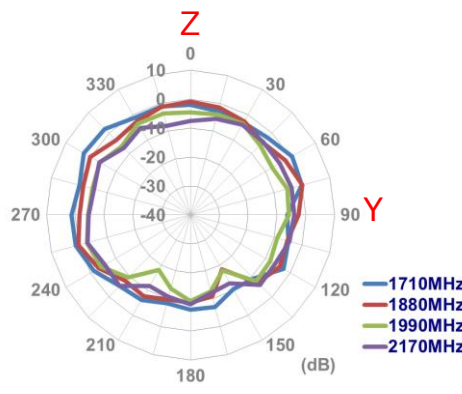
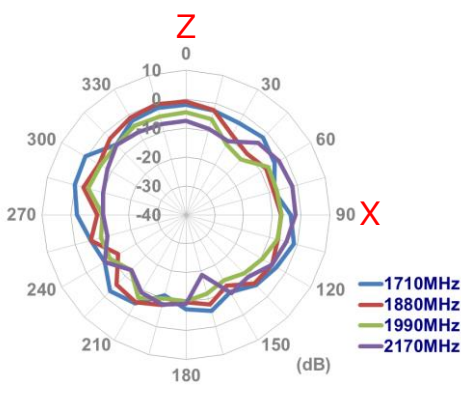
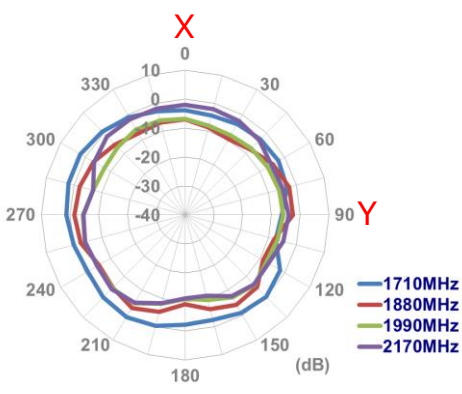
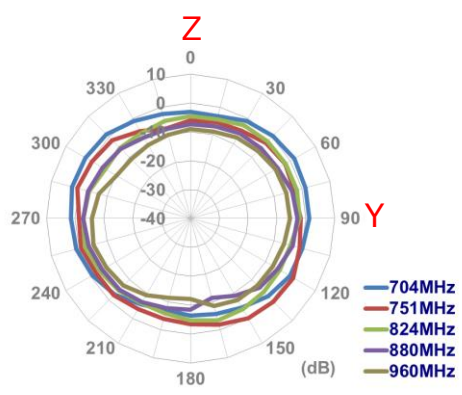
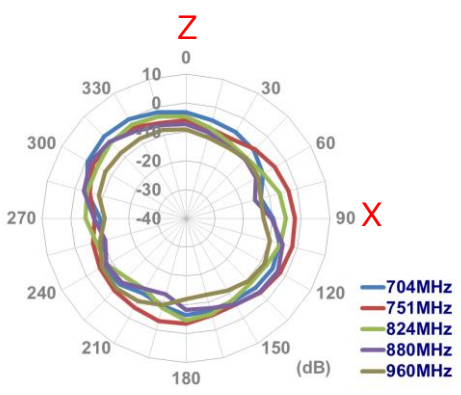
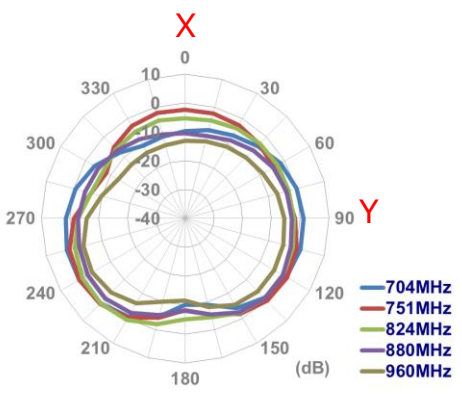



3.1.8. 2D Radiation pattern (MIMO2 with 2M cable length in free space)

XY Plane

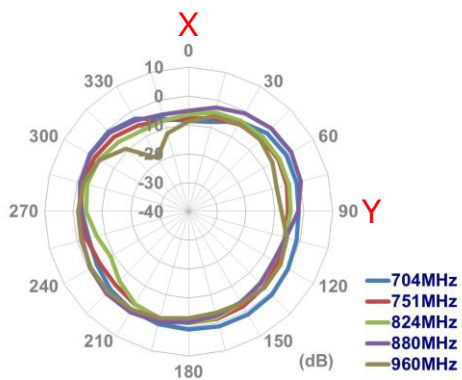

XZ Plane

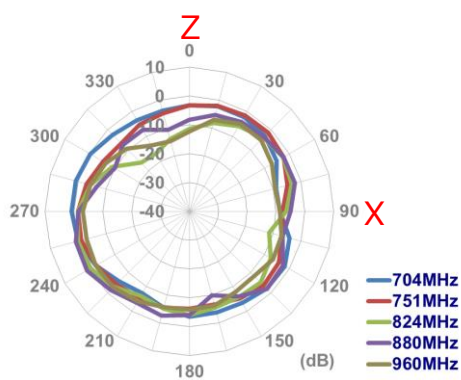

YZ Plane

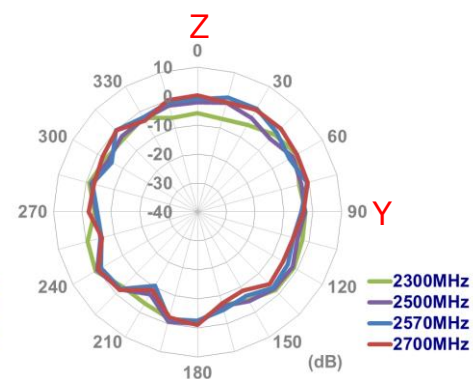
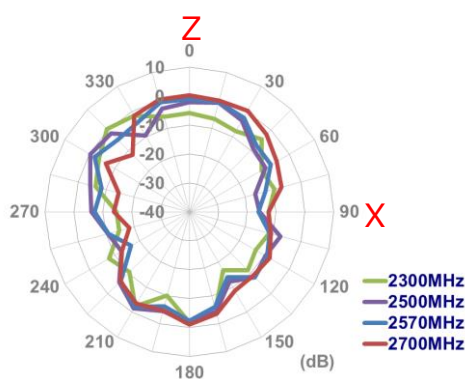
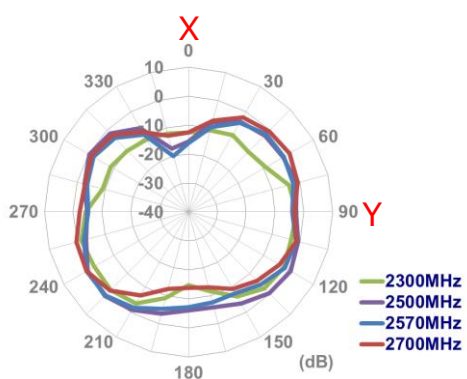
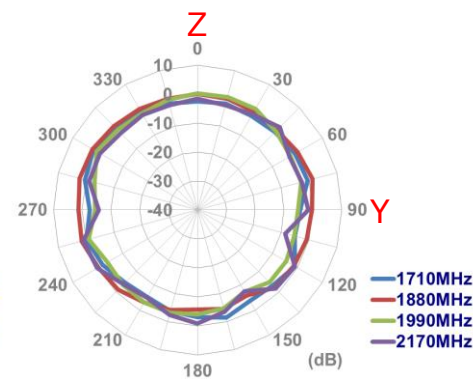
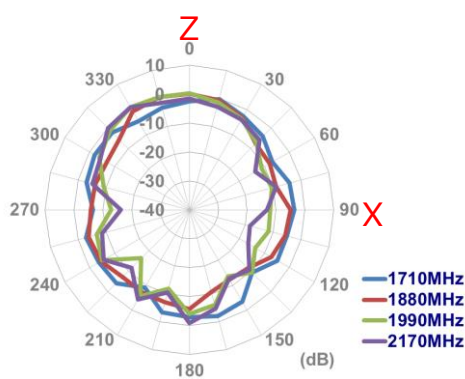
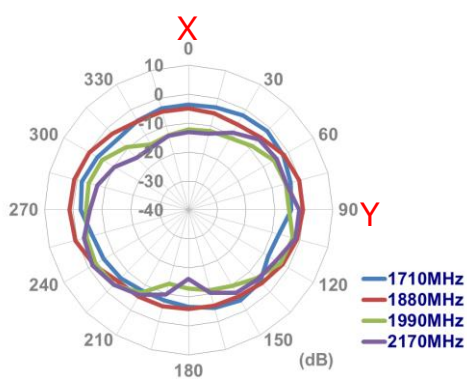
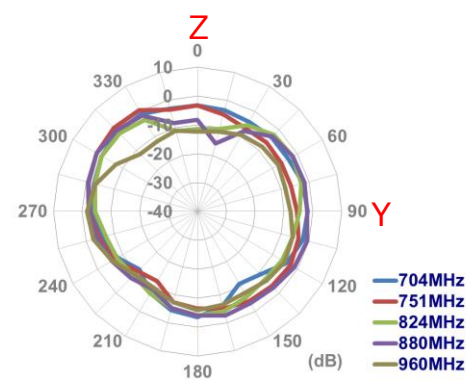

3.1.9. Test Setup For Antenna Radiation Pattern (ETS Anechoic chamber)

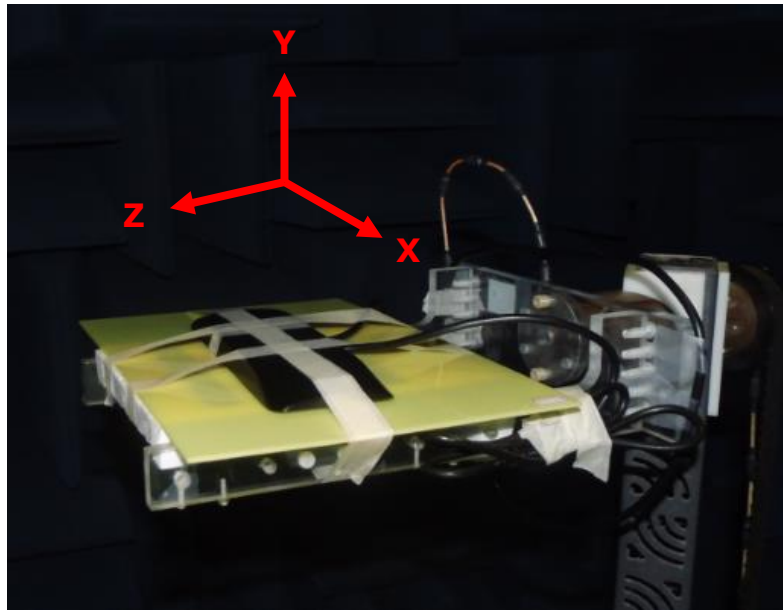

On the 2mm ABS base



3.1.10. 2D Radiation pattern (MIMO1 with 2M cable length on the 2mm ABS)

XY Plane

XZ Plane

YZ Plane

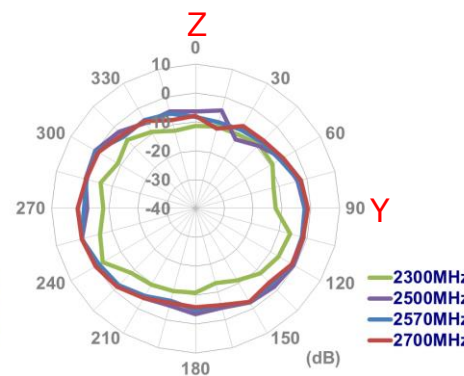
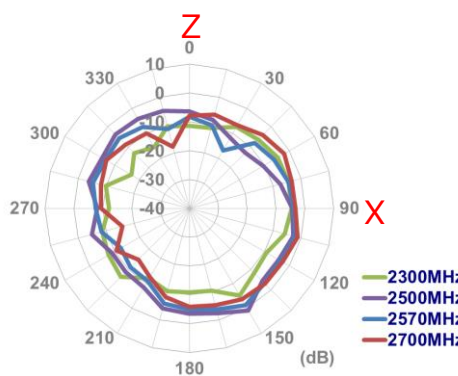
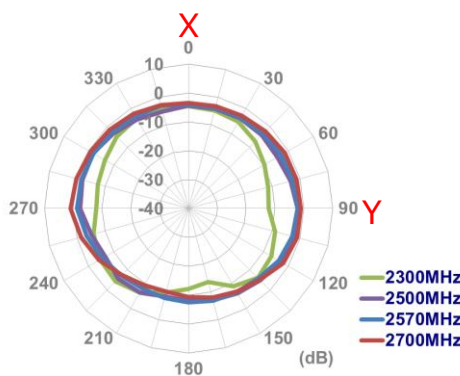
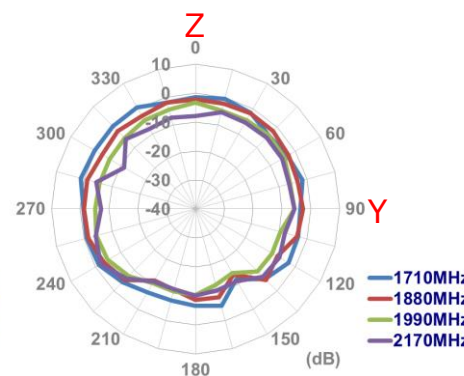
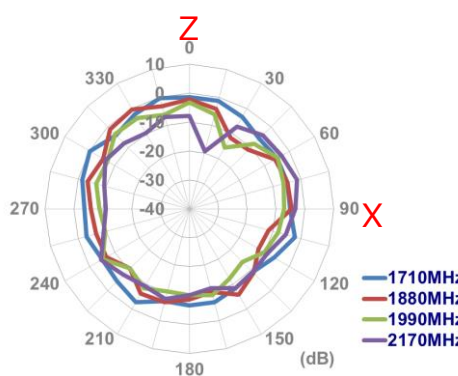
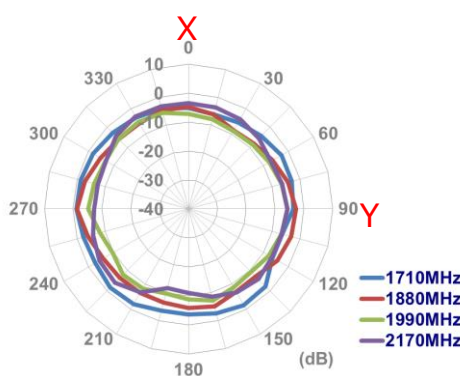
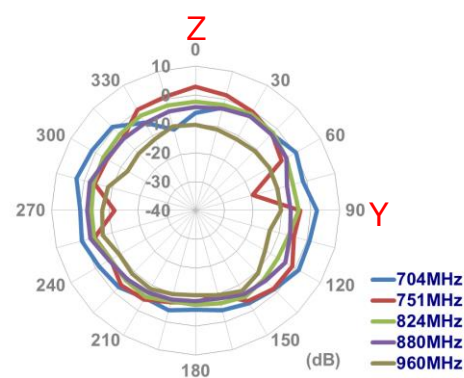
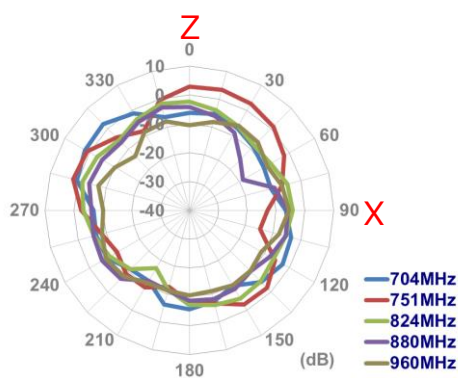
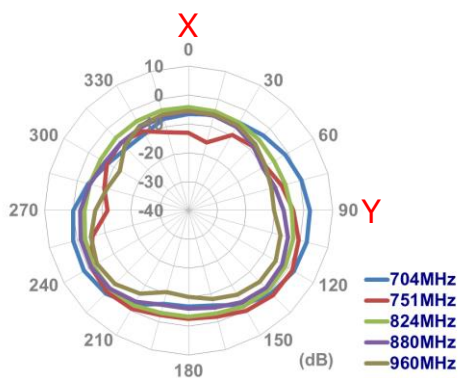



3.1.11. 2D Radiation pattern (MIMO2 with 2M cable length on the 2mm ABS)

XY Plane

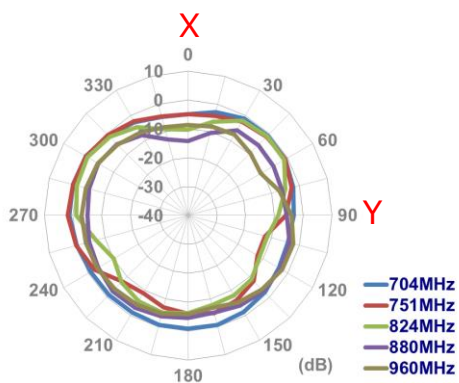

XZ Plane

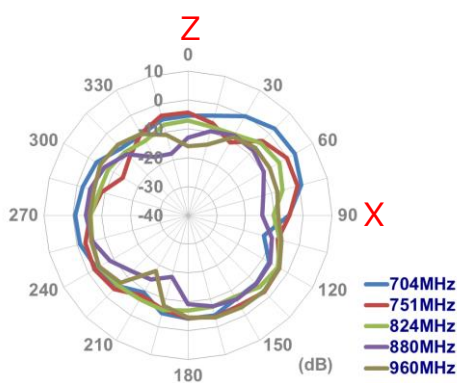

YZ Plane

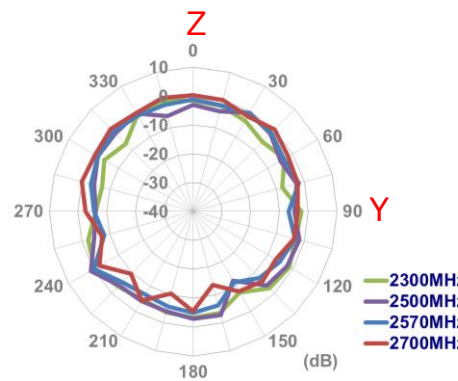
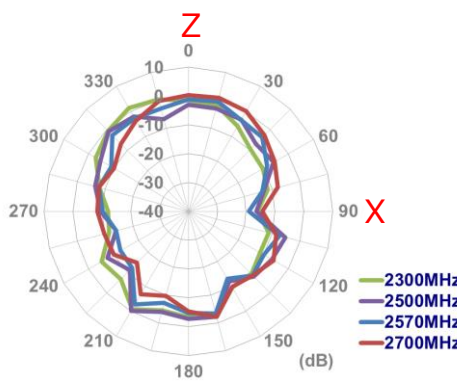
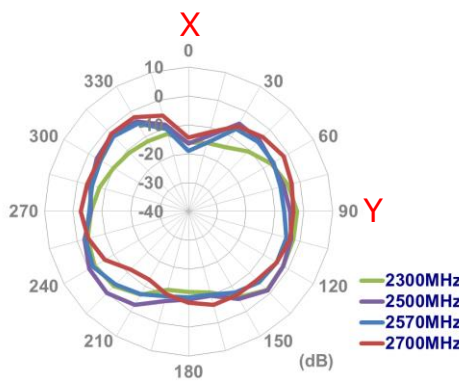
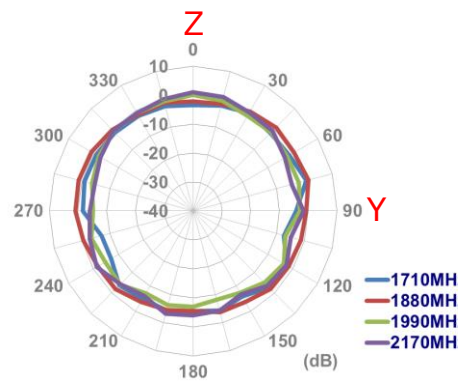
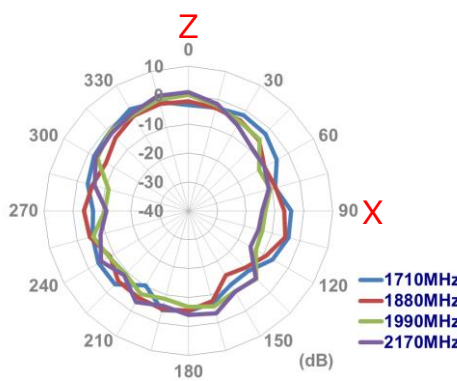
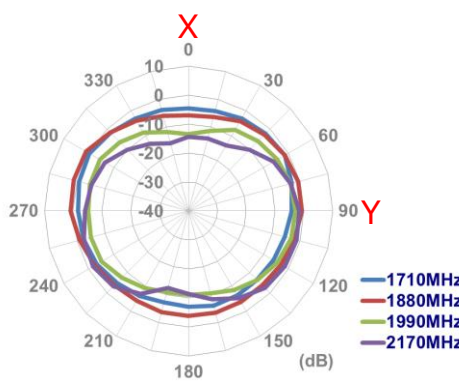
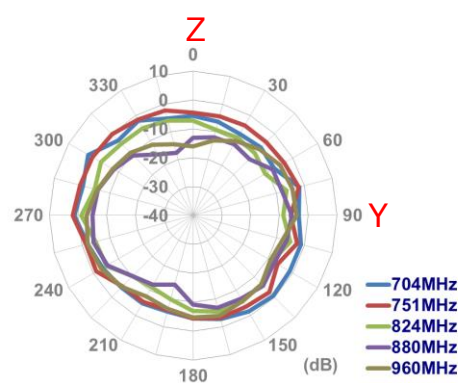

3.1.12. Test Setup for Antenna Radiation Pattern (ETS Anechoic chamber)

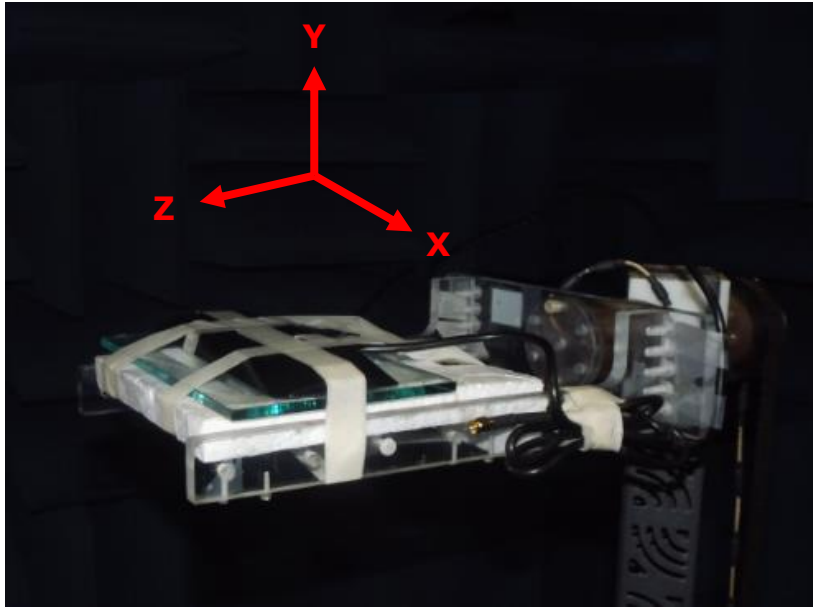

On the glass base



3.1.13. 2D Radiation pattern (MIMO1 with 2M cable length on the glass)

XY Plane

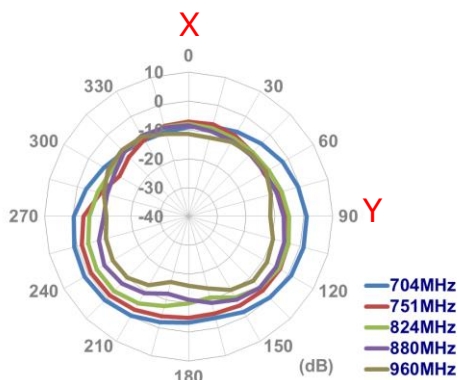

XZ Plane

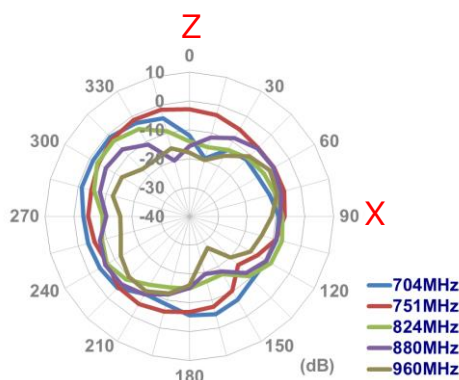

YZ Plane

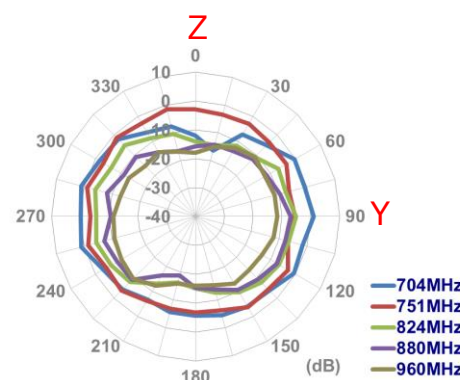

X

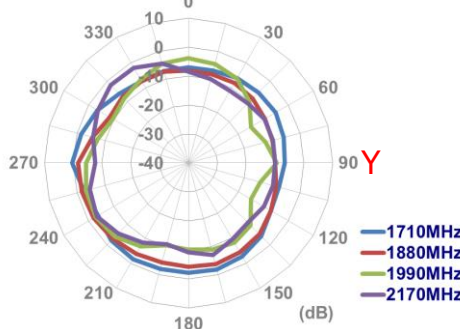

Z

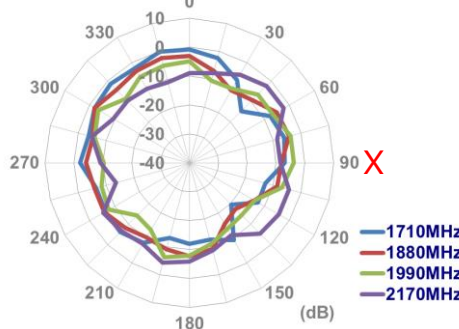

Z

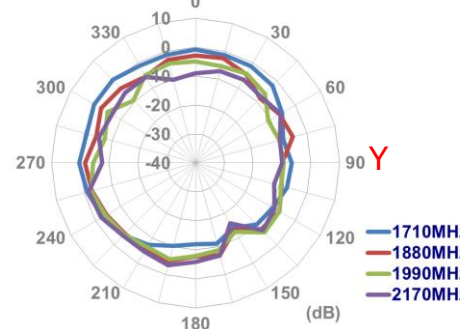

X

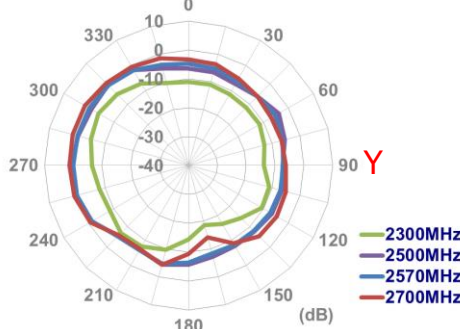

Z

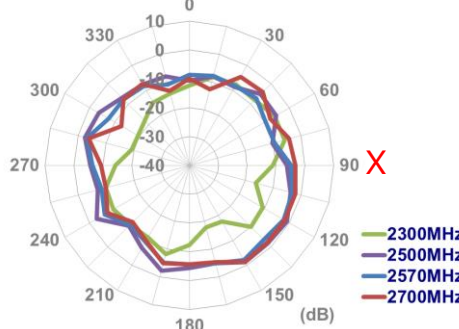

Z

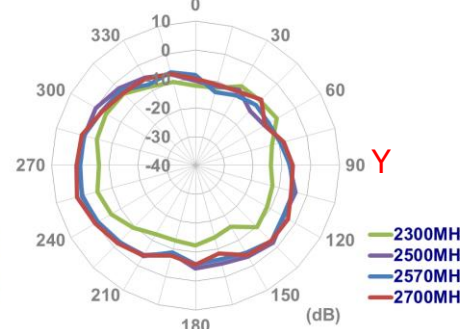



3.1.14. 2D Radiation pattern (MIMO2 with 2M cable length on the glass)

XY Plane

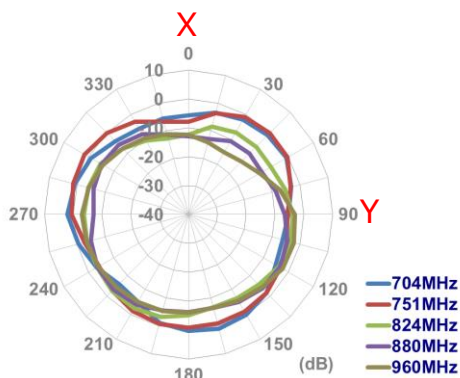

XZ Plane

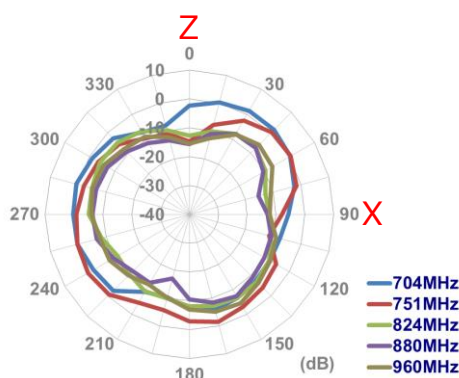

YZ Plane

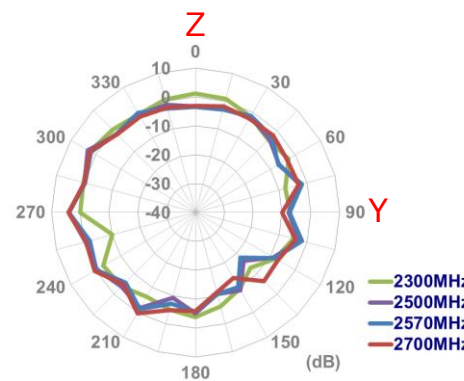
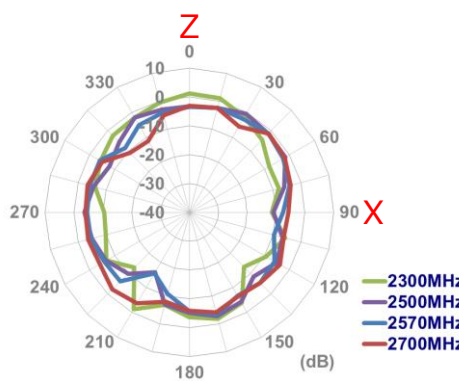
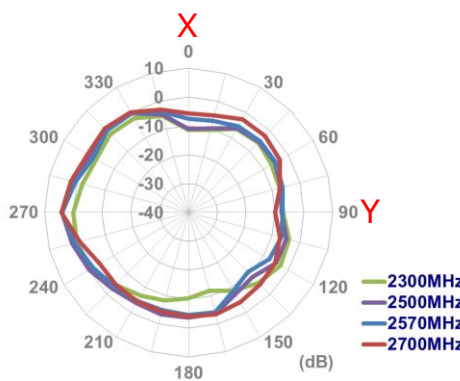
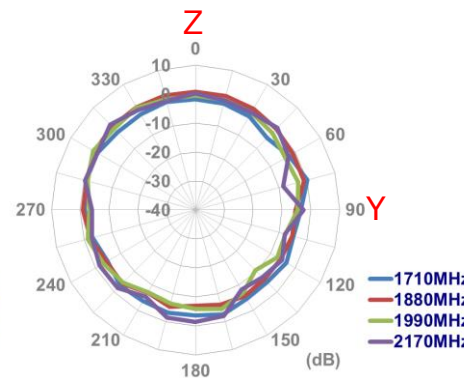
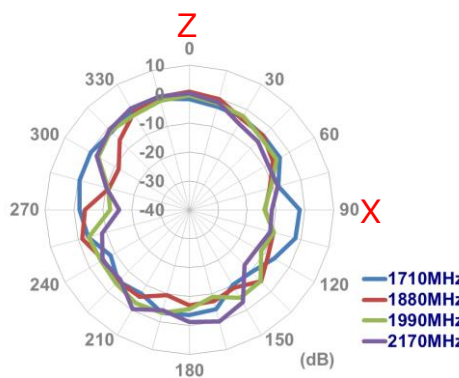
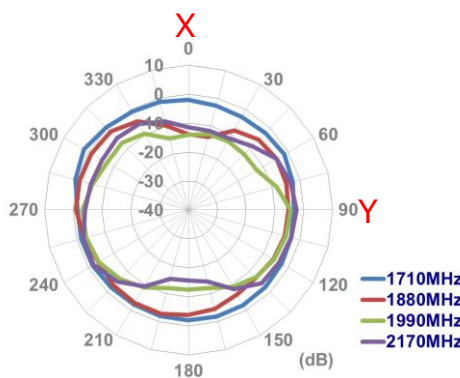
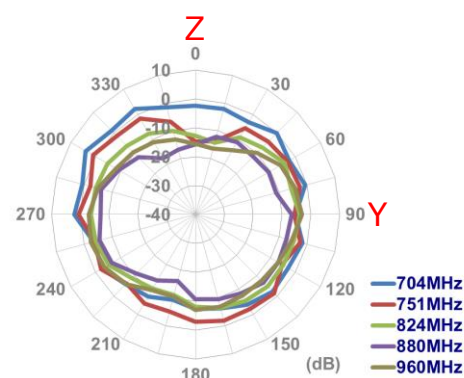



4. Drawing

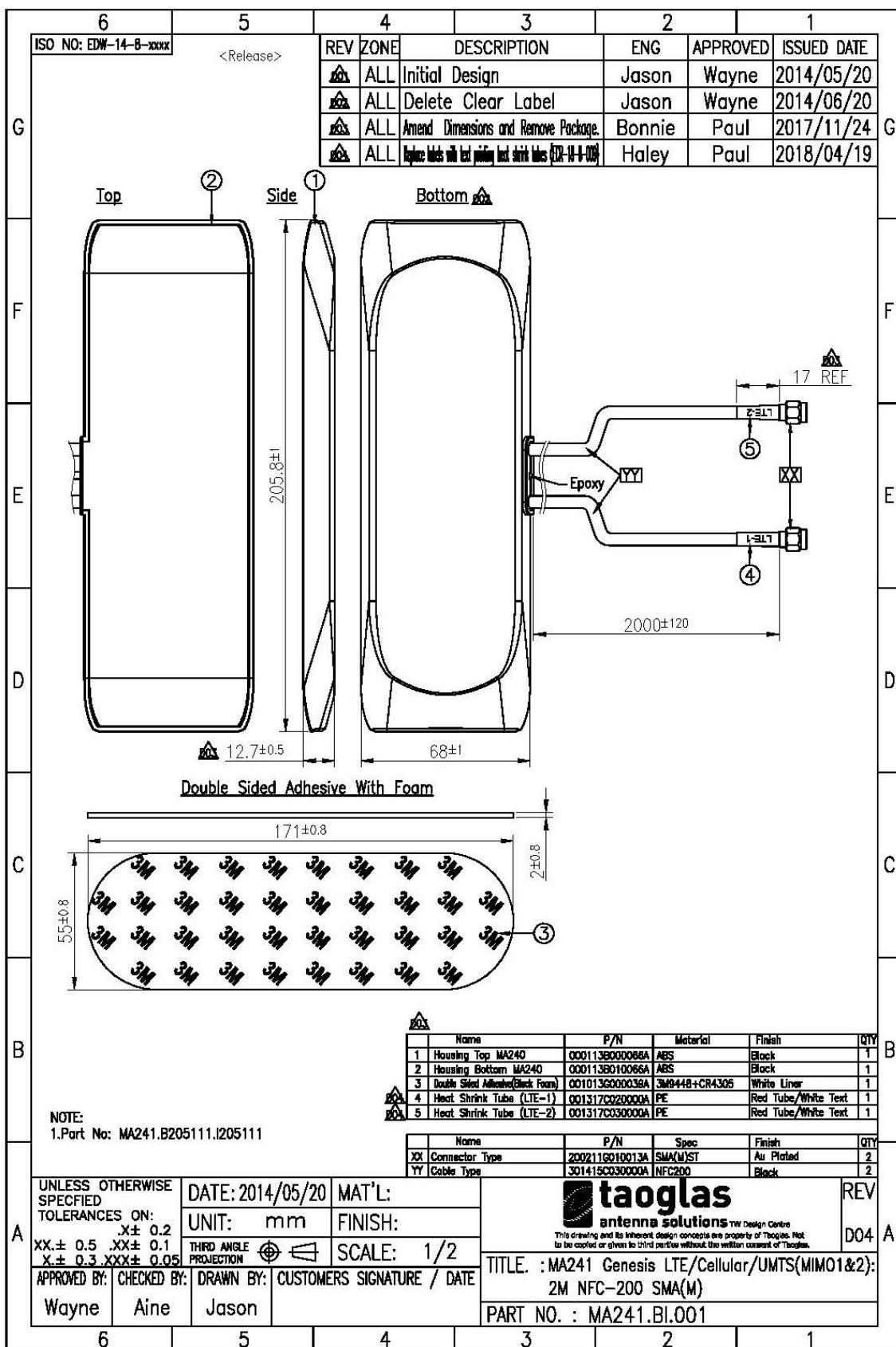



5. Packaging

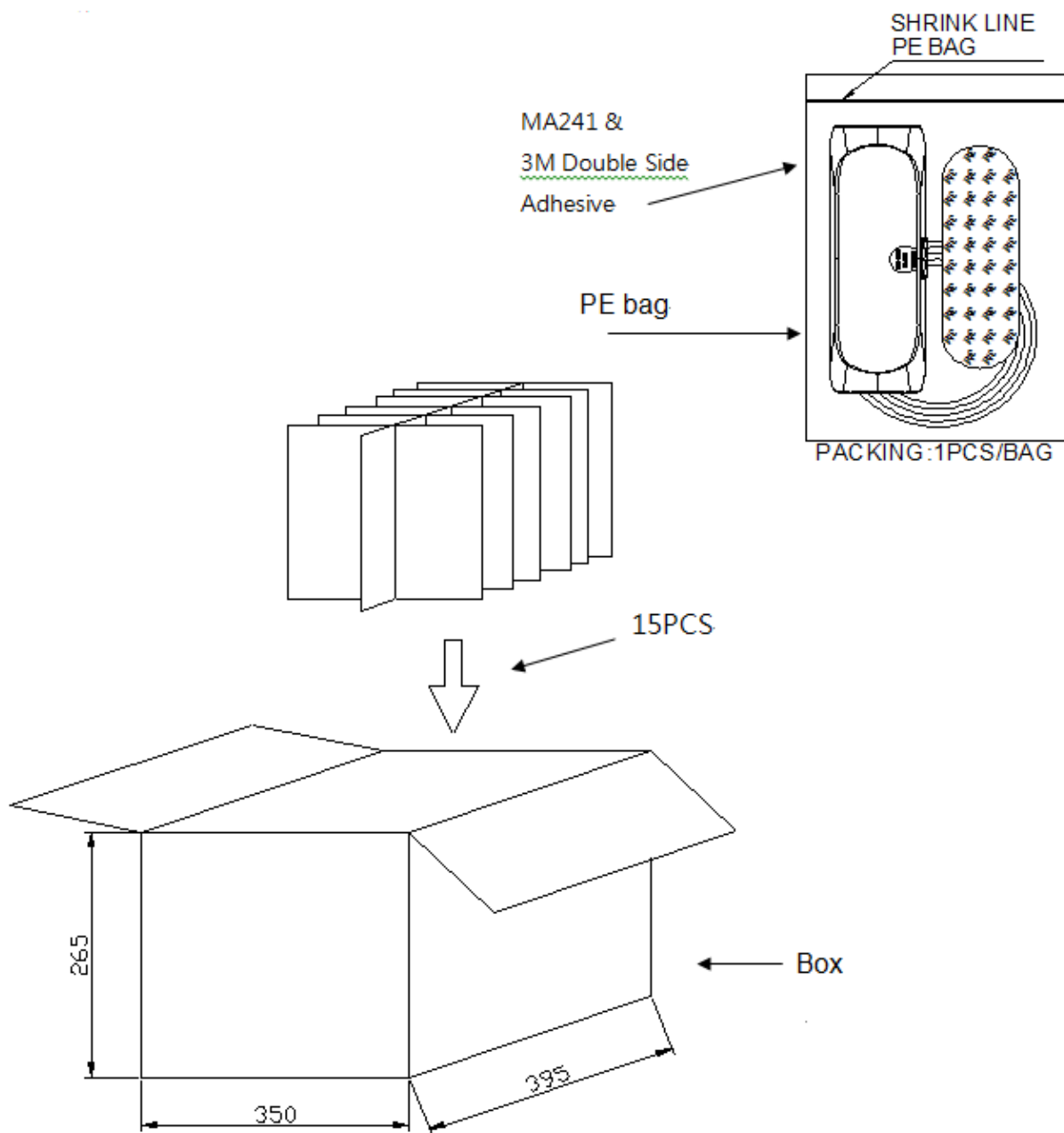



6. Application Note (LTE MIMO Antenna)

The MA241 antenna measurement with difference cable length and difference environments, the performance is shown as below,

6.1. In free space

6.1.1. Return loss (MIMO_1 in free space)

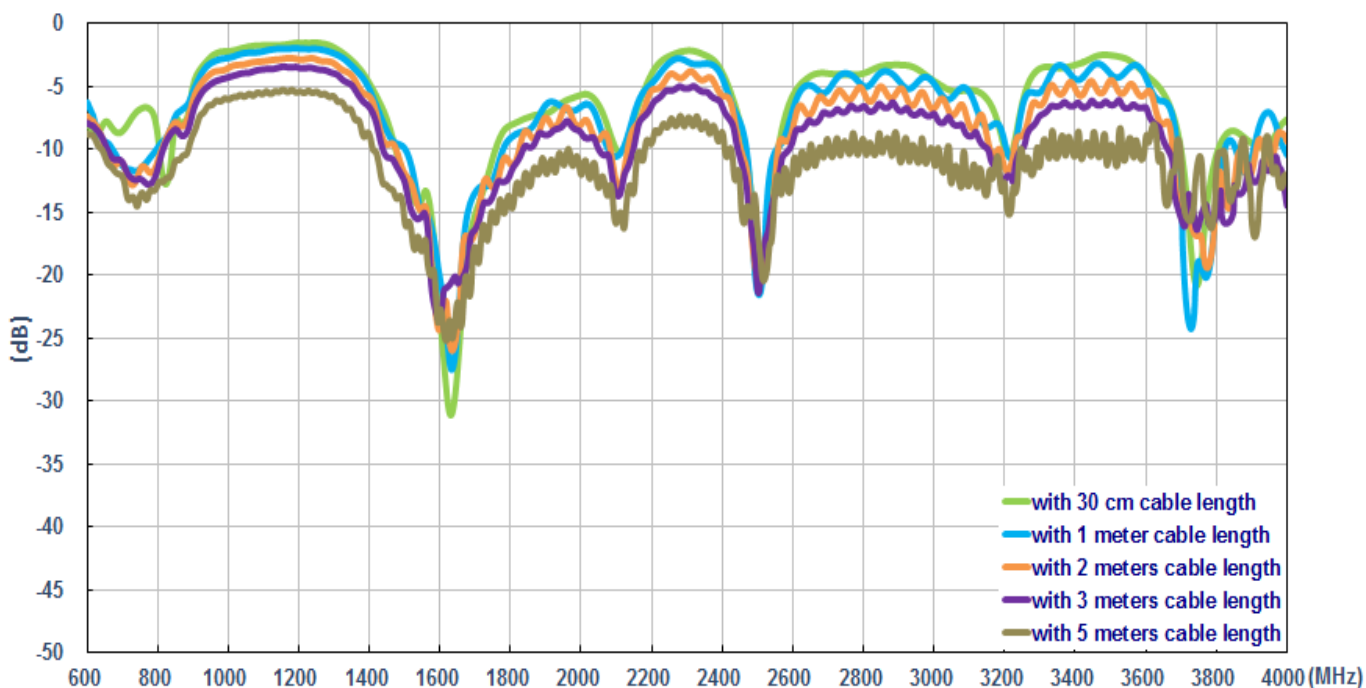

6.1.2. Return loss (MIMO_2 in free space)

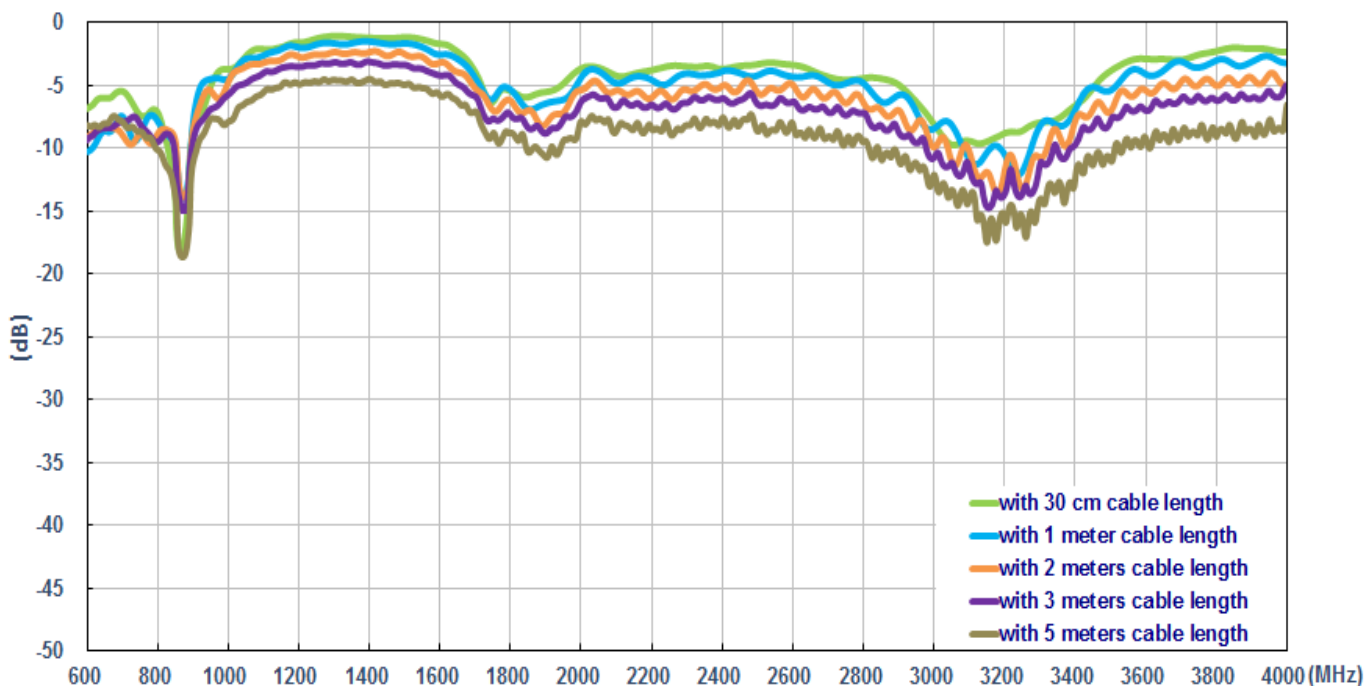



6.1.3. Insertion loss (in free space)

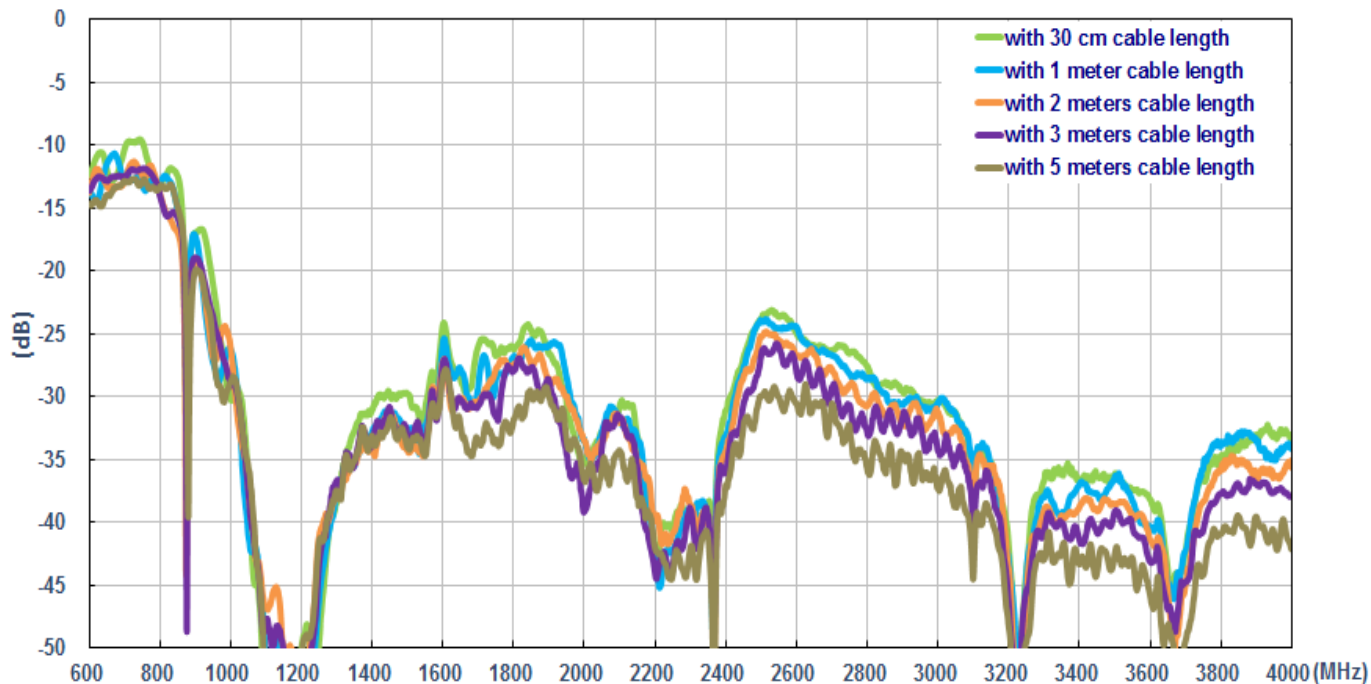

6.1.4. Efficiency (MIMO_1 in free space)

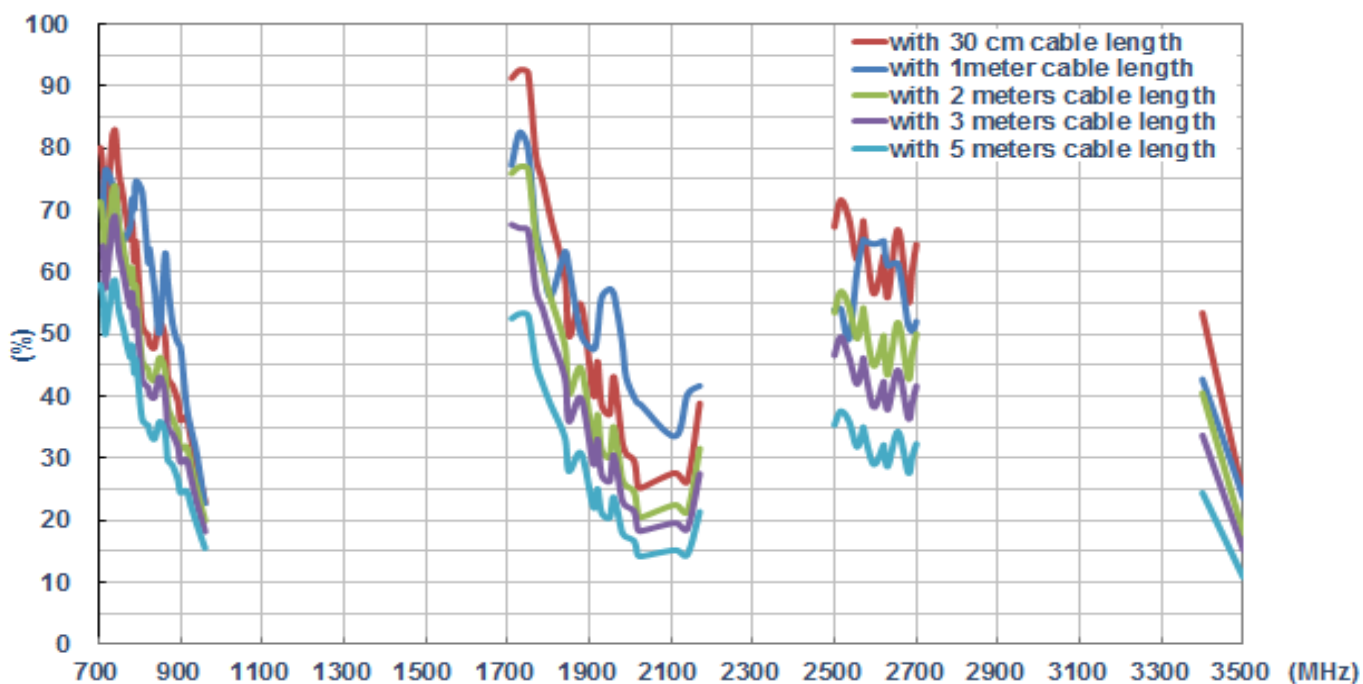



6.1.5. Efficiency (MIMO_2 in free space)

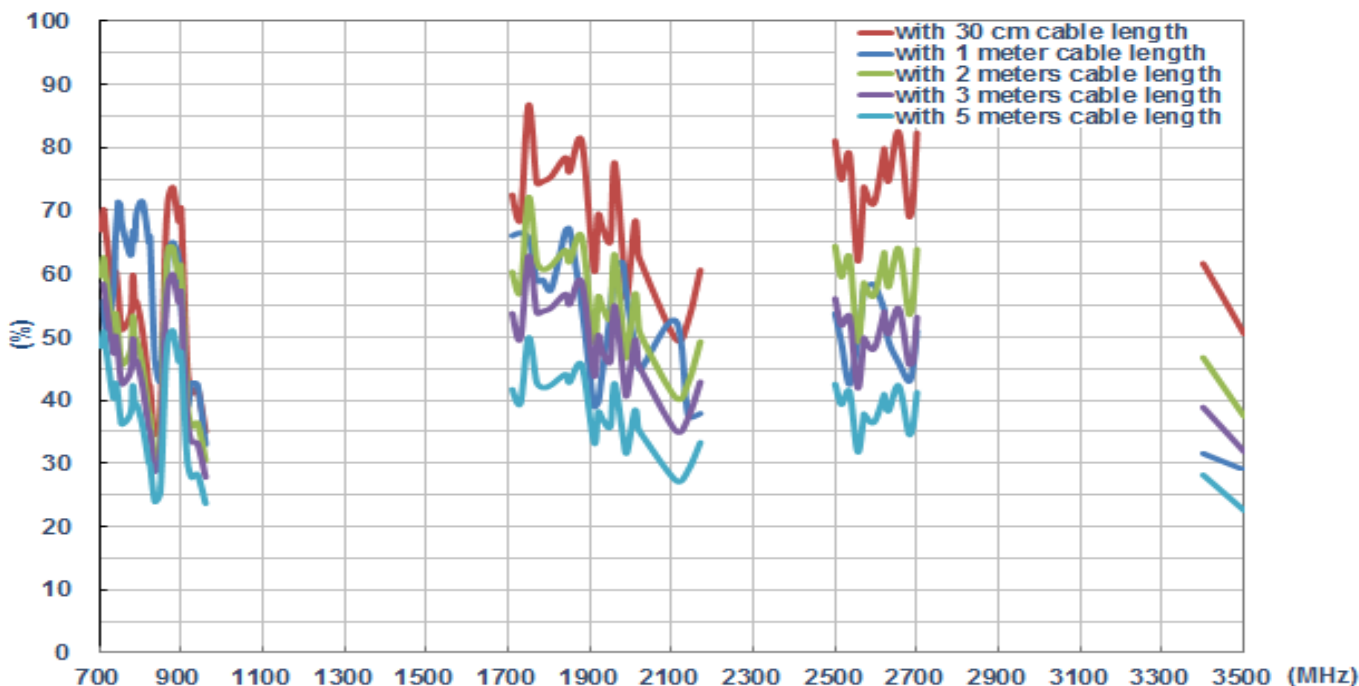

6.1.6. Average Gain (MIMO_1 in free space)

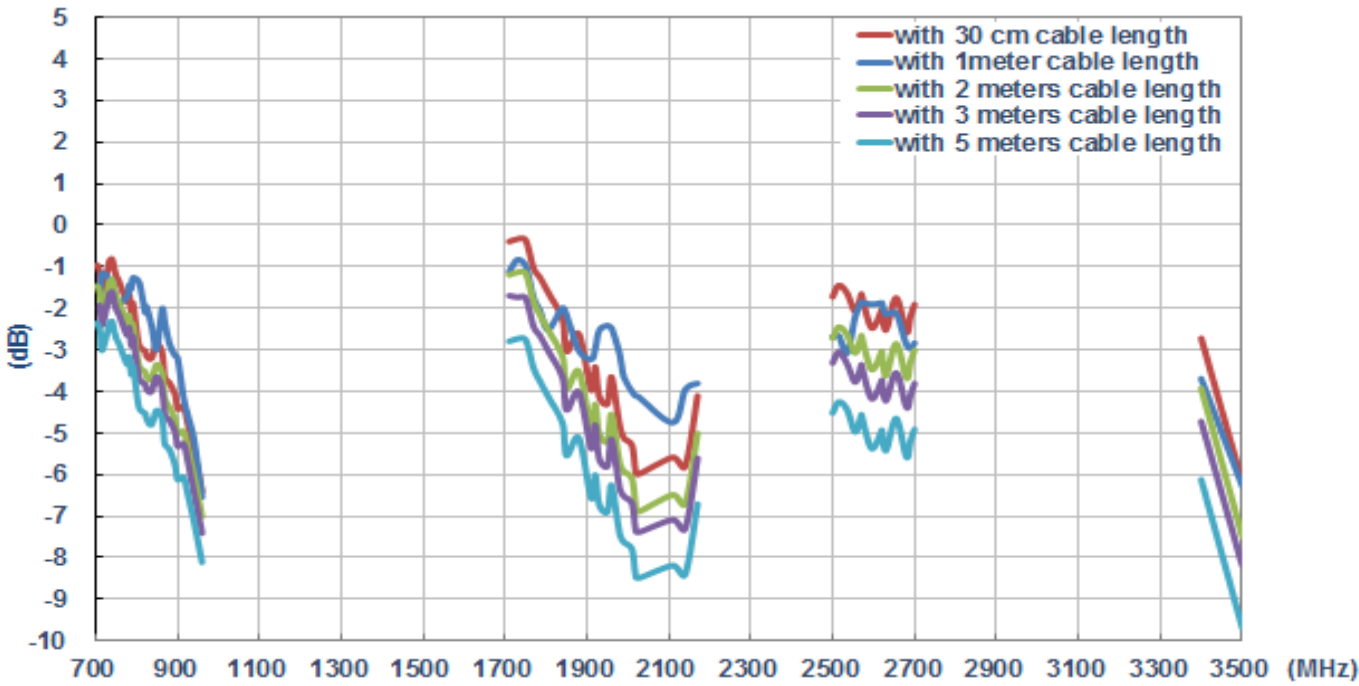



6.1.7. Average Gain (MIMO_2 in free space)

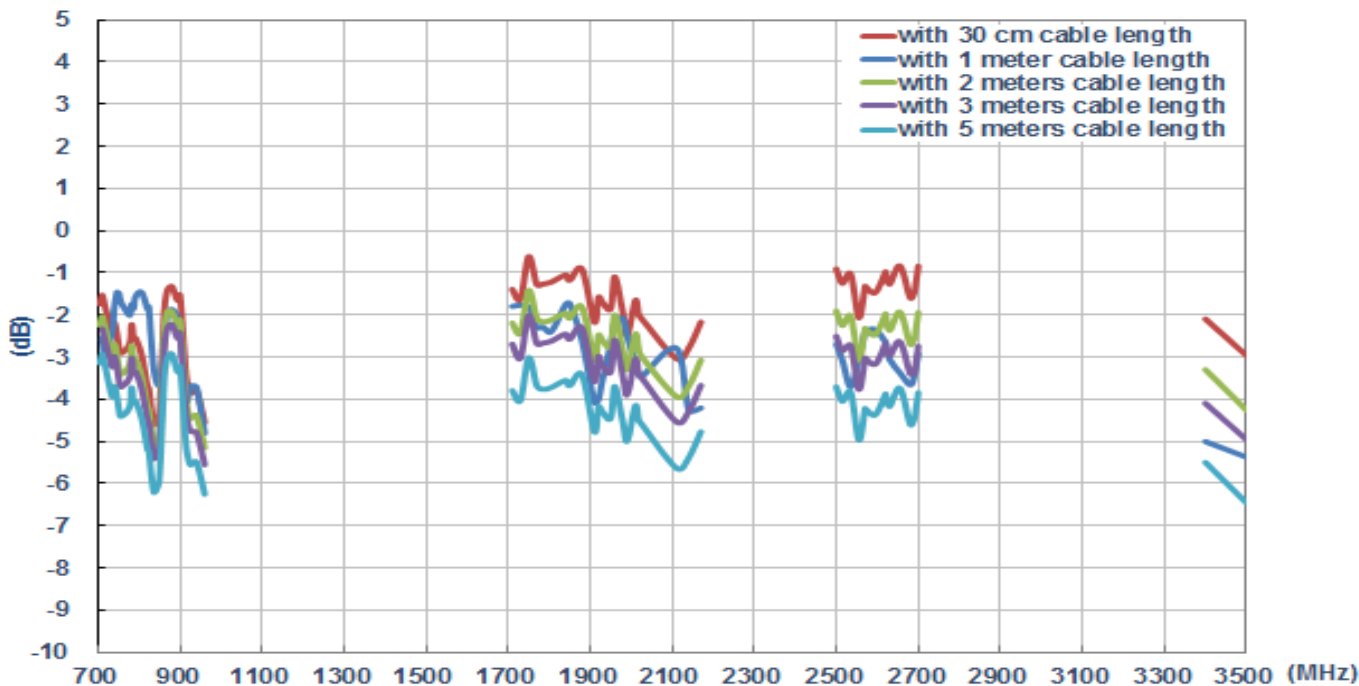

6.1.8. Peak Gain (MIMO_1 in free space)

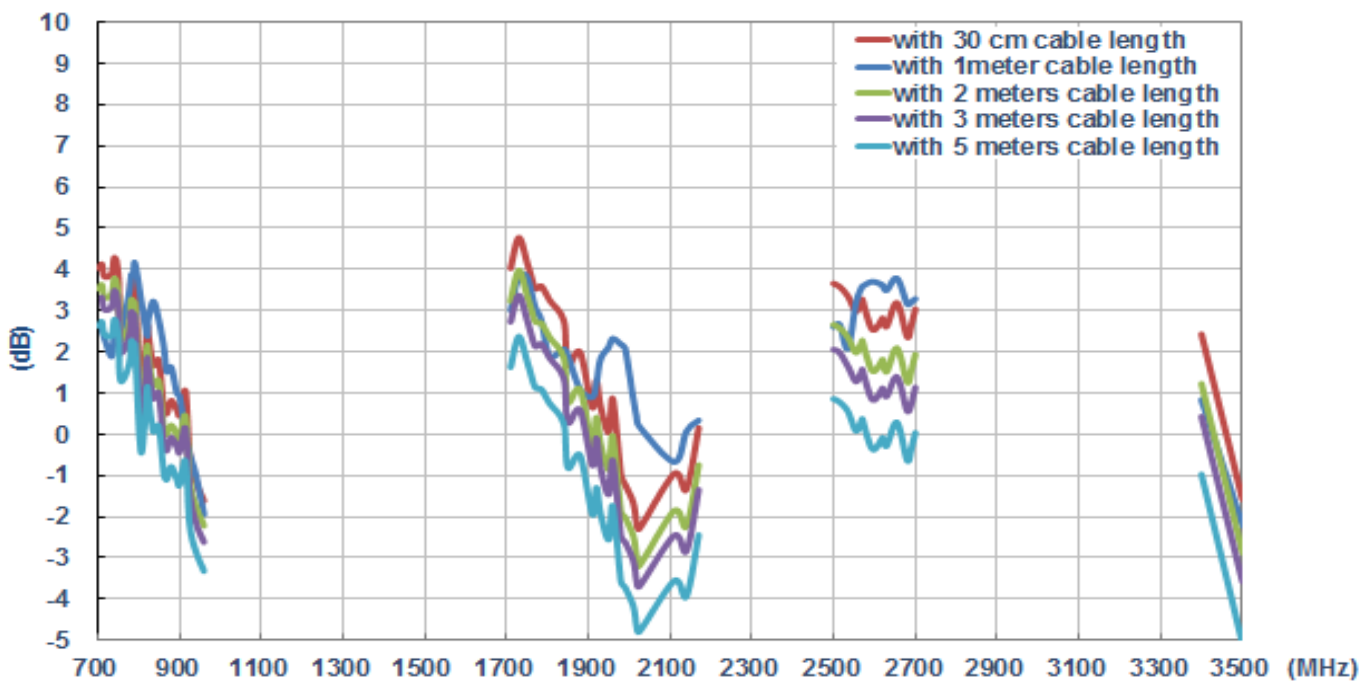



6.1.9. Peak Gain (MIMO_2 in free space)

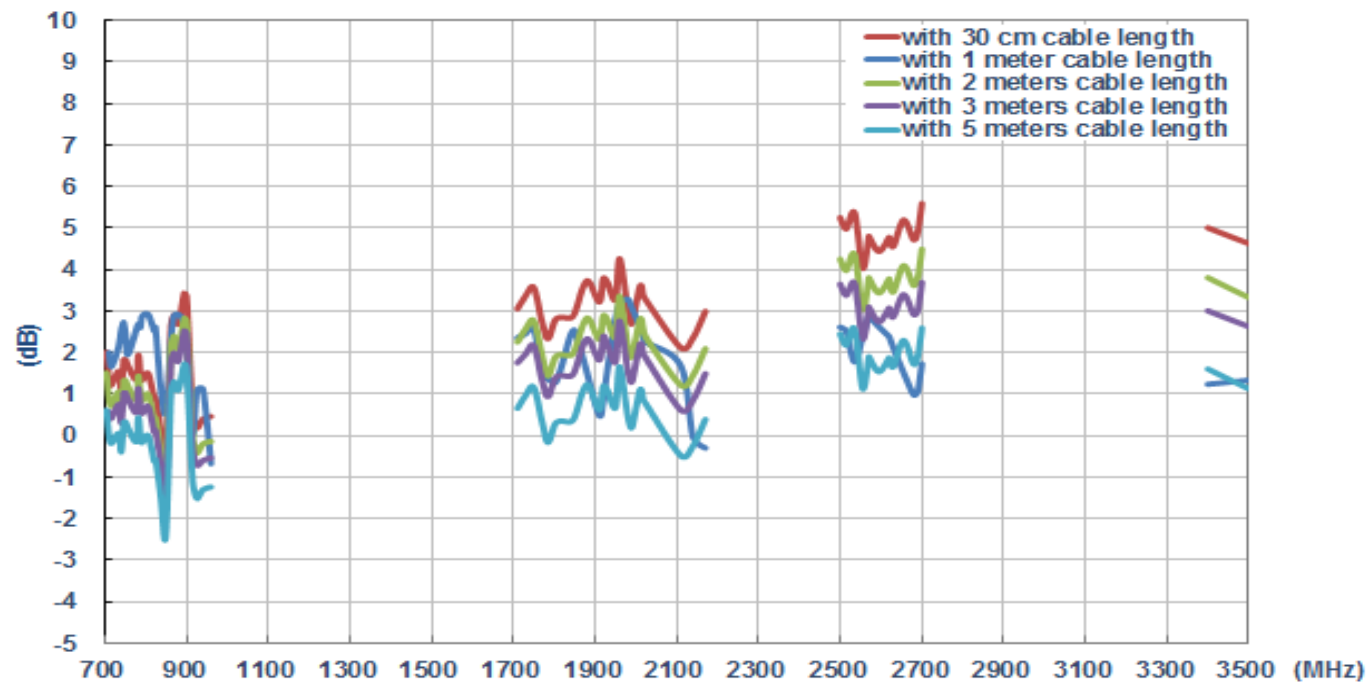

6.2. On 2mm ABS base

6.2.1. Return Loss (MIMO_1 on the 2mm ABS)

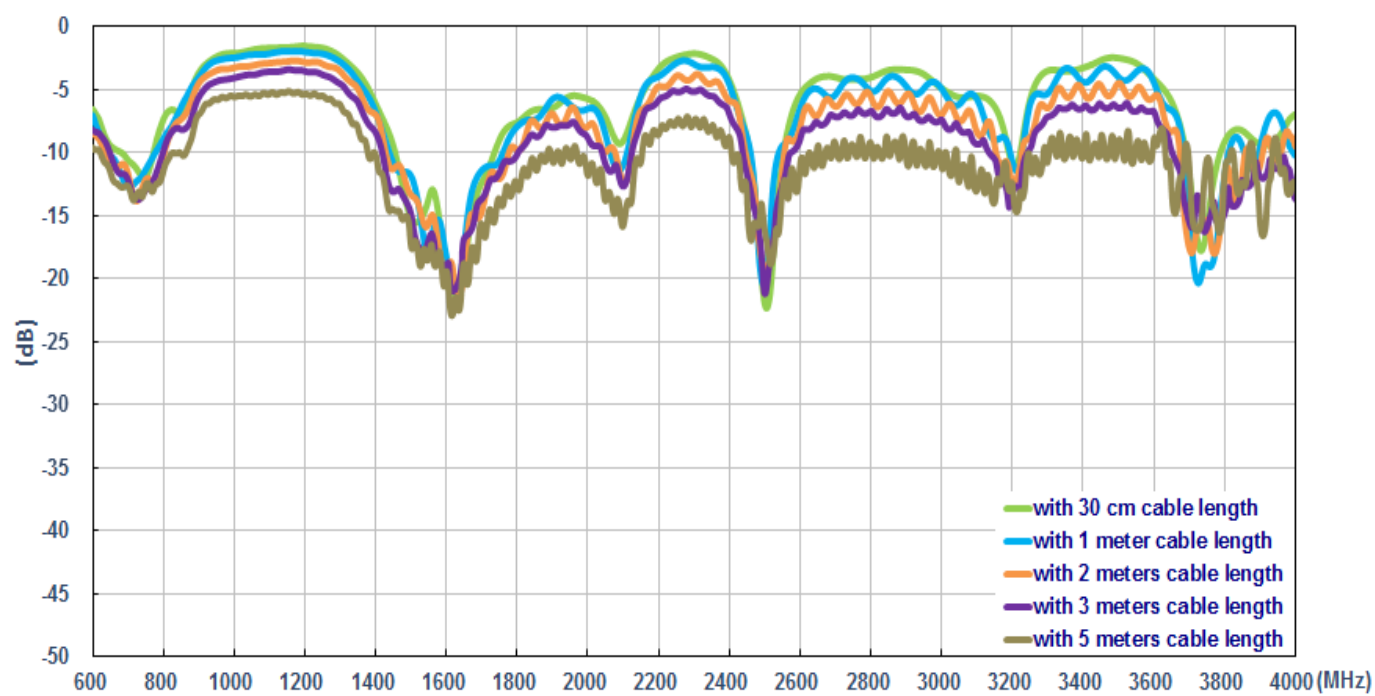



6.2.2. Return loss (MIMO_2 on the 2mm ABS)

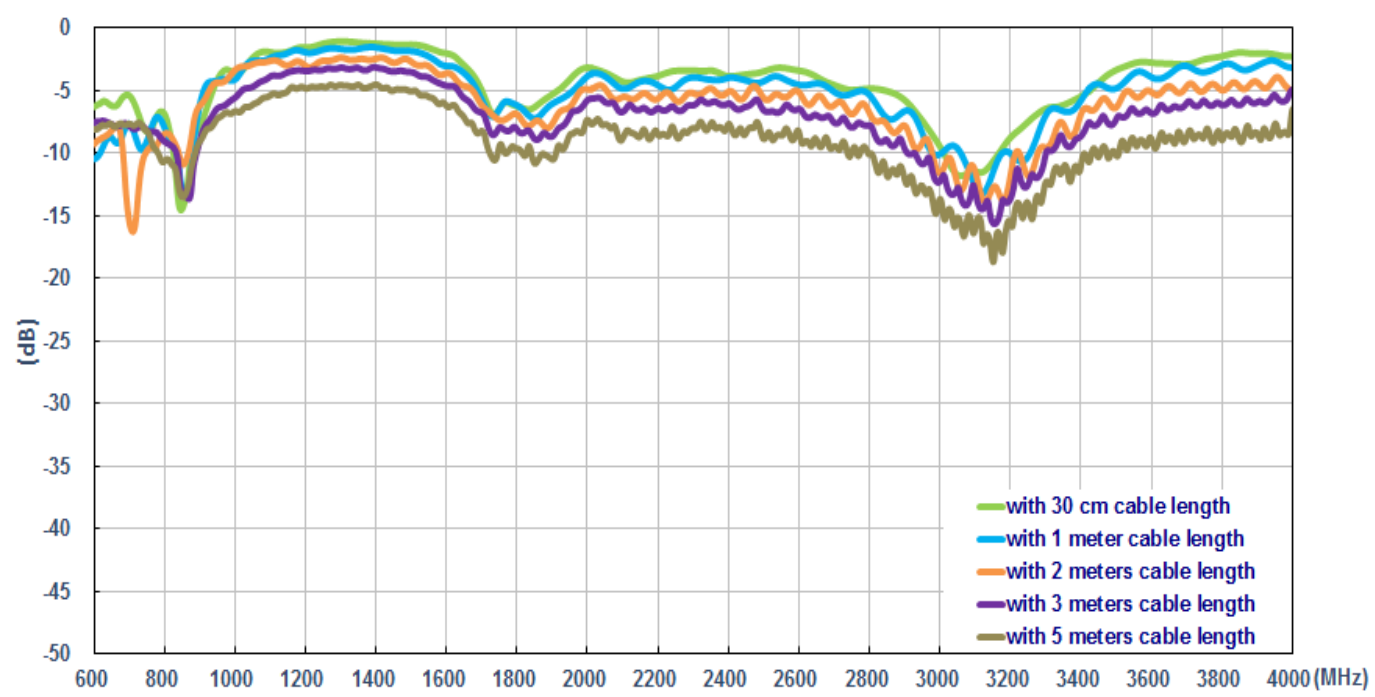

6.2.3. Insertion Loss (on the 2mm ABS)

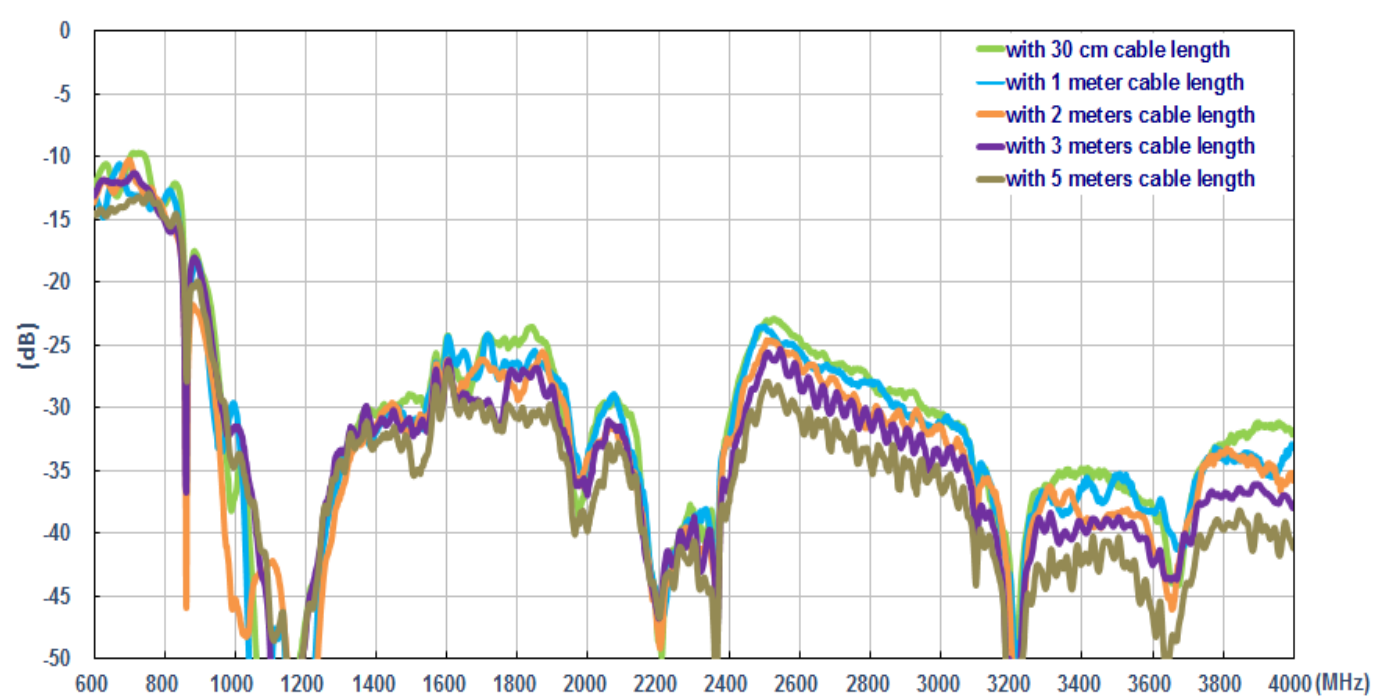



6.2.4. Efficiency (MIMO_1 on the 2mm ABS)

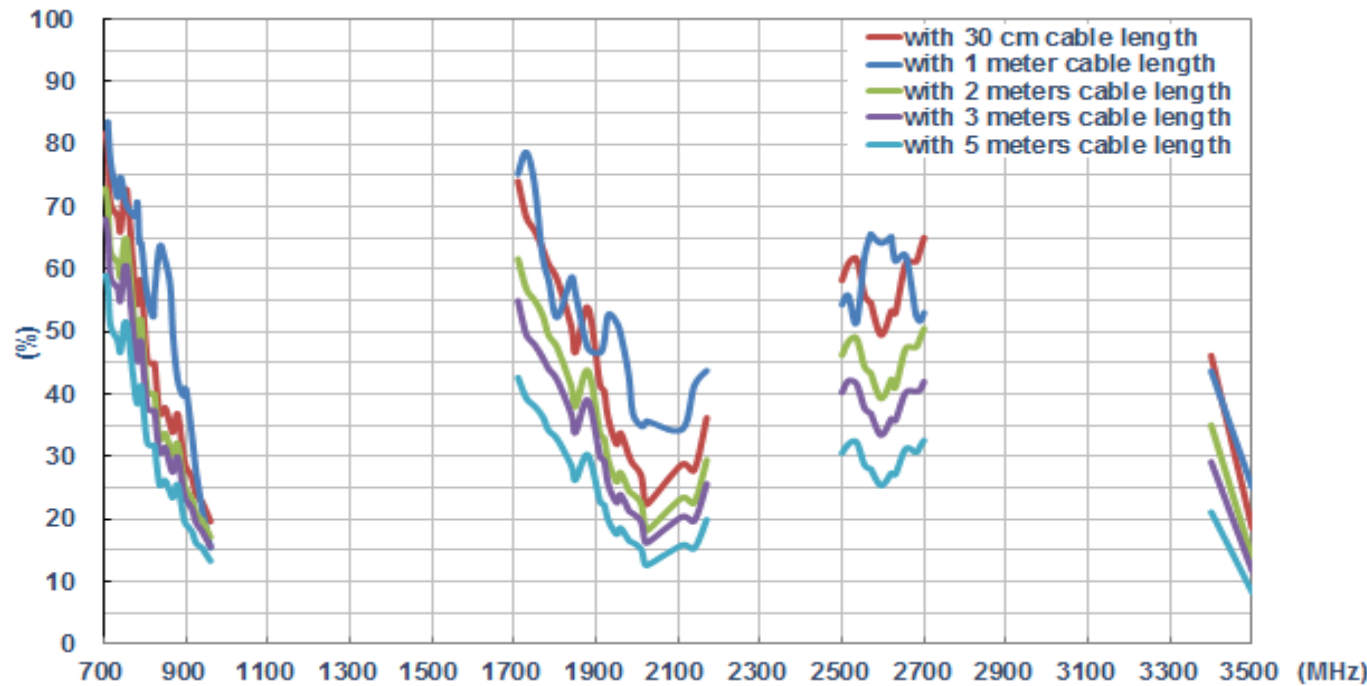

6.2.5. Efficiency (MIMO_2 on the 2mm ABS)

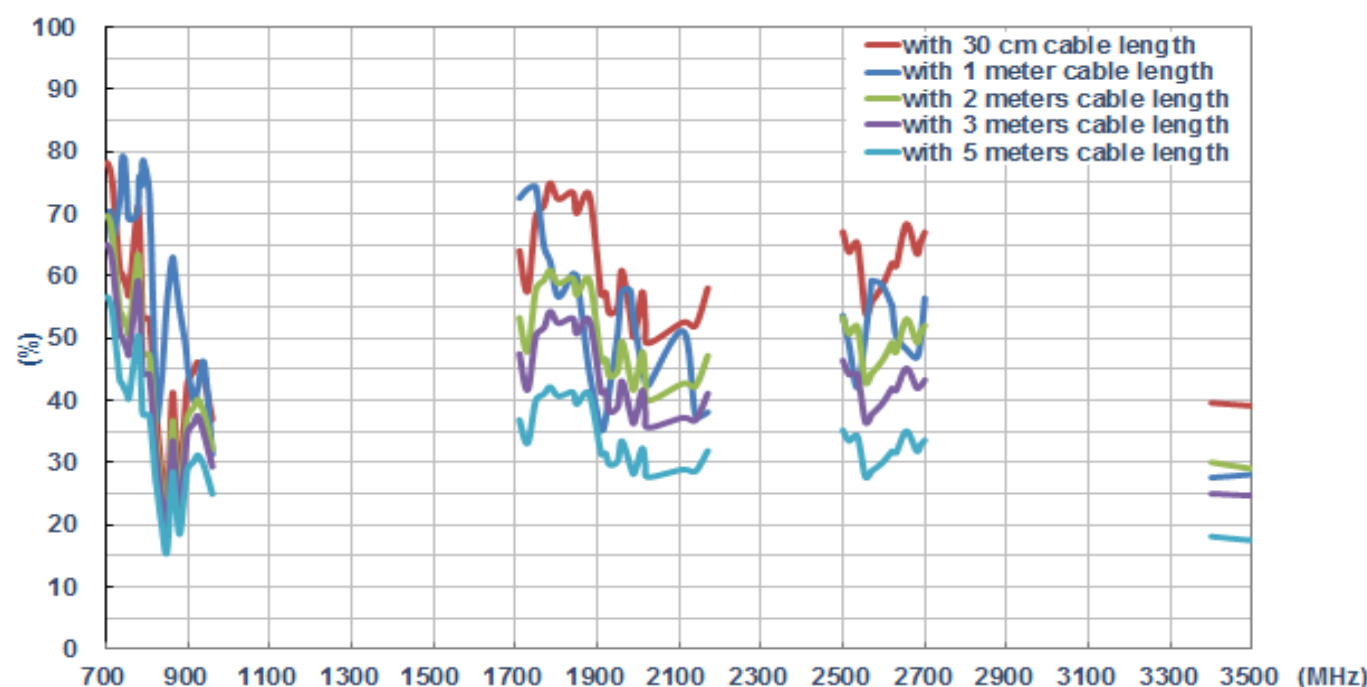



6.2.6. Average Gain (MIMO_ on the 2mm ABS)

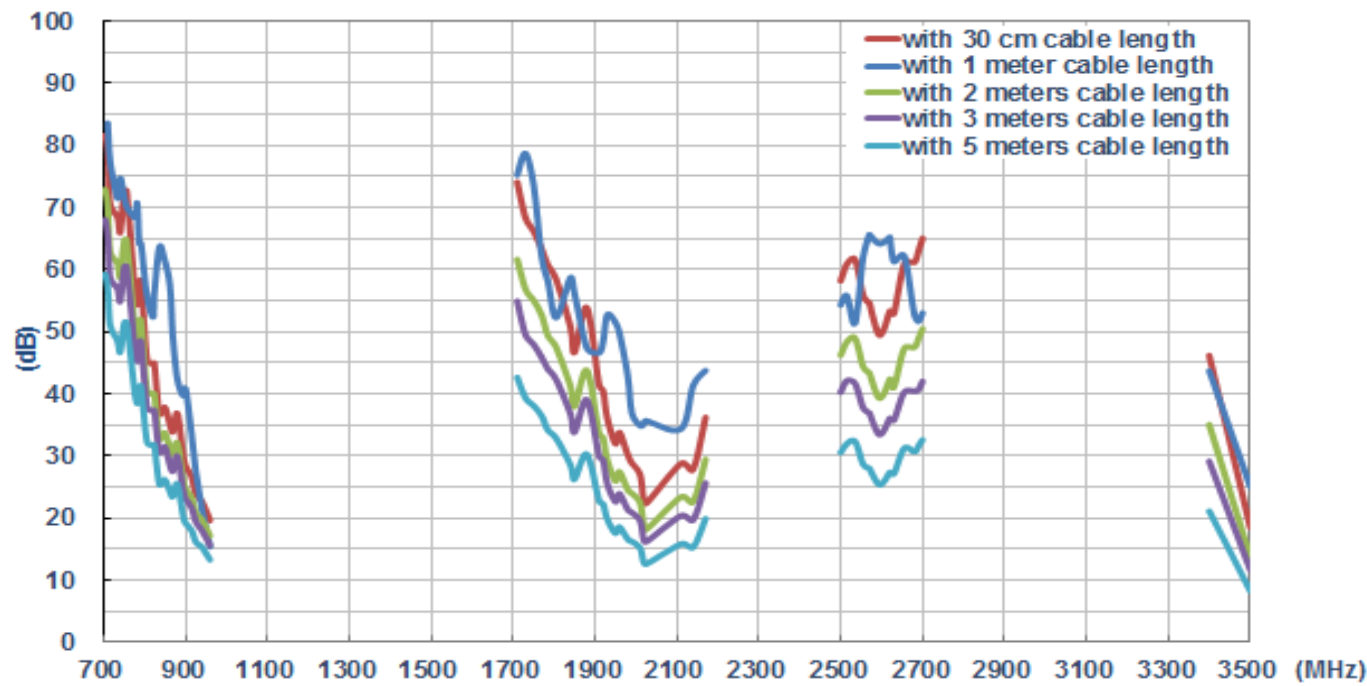

6.2.7. Average Gain (MIMO_2 on the 2mm ABS)

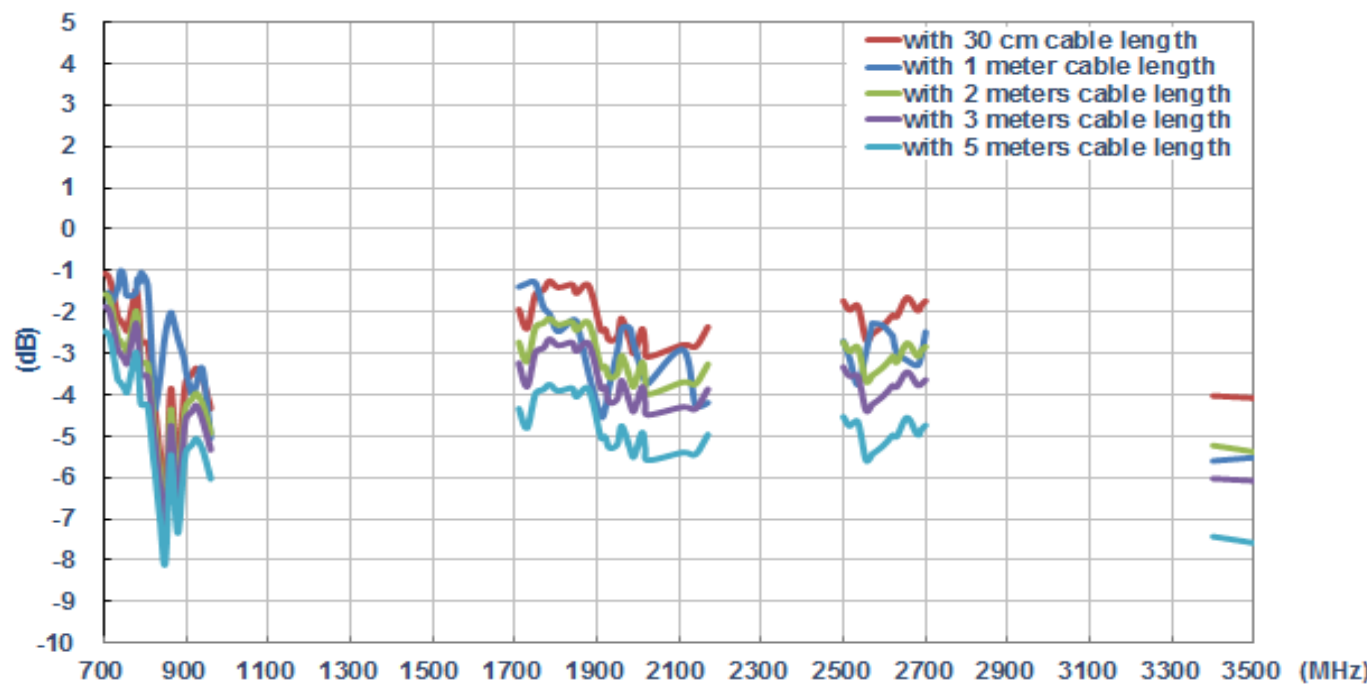



6.2.8. Peak Gain (MIMO_1 on the 2mm ABS)

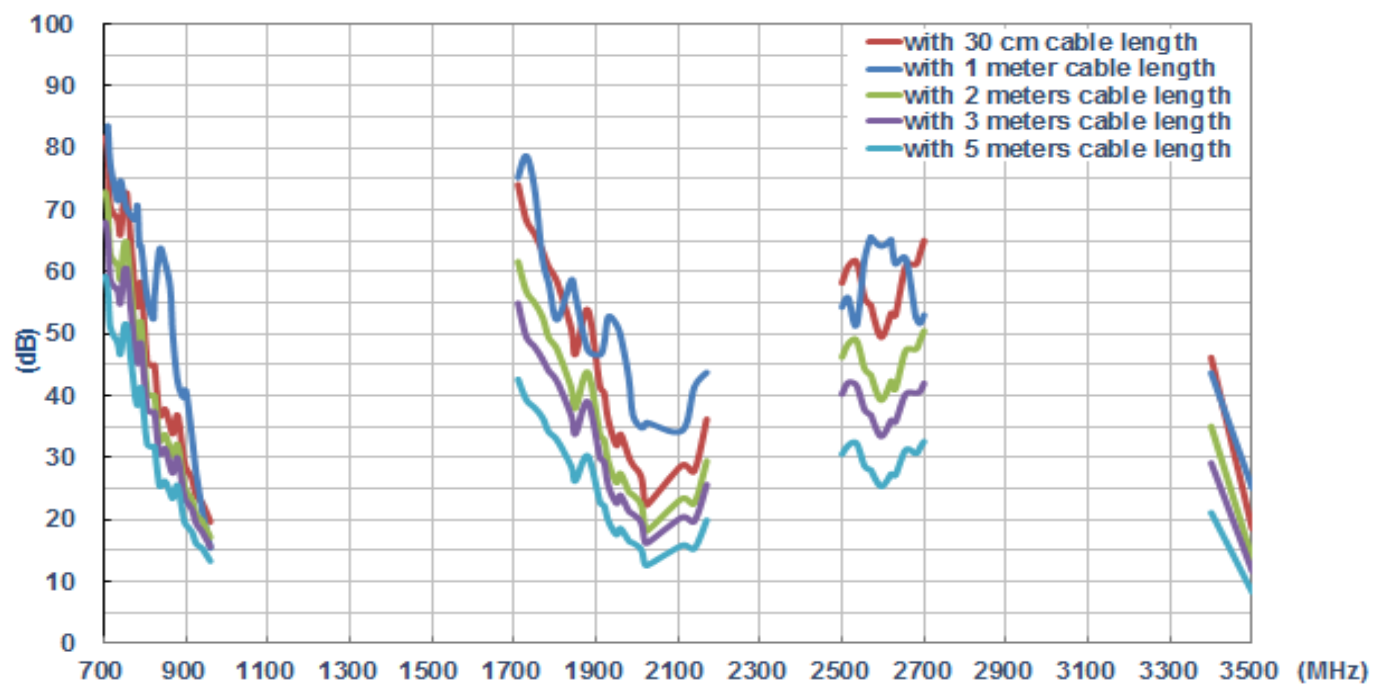

6.2.9. Peak Gain (MIMO_2 on the 2mm ABS)

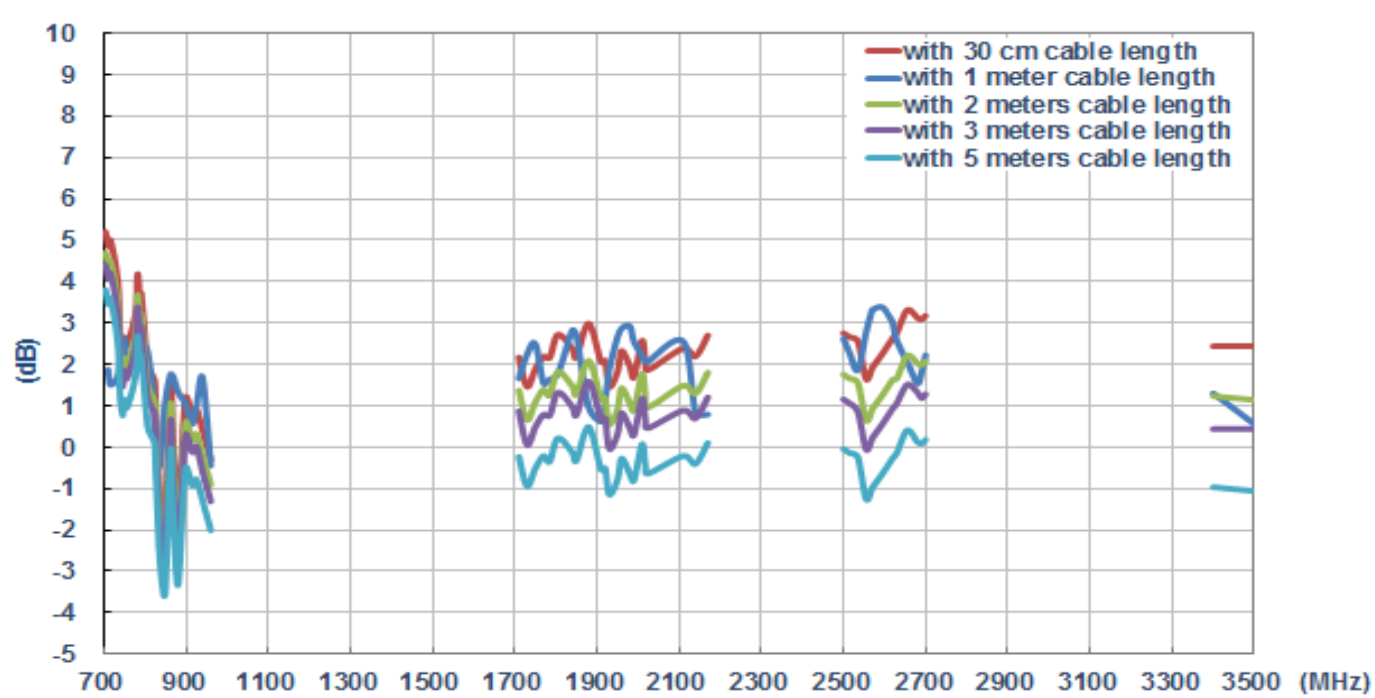



6.3. On glass base

6.3.1. Return loss (MIMO_1 on the glass)

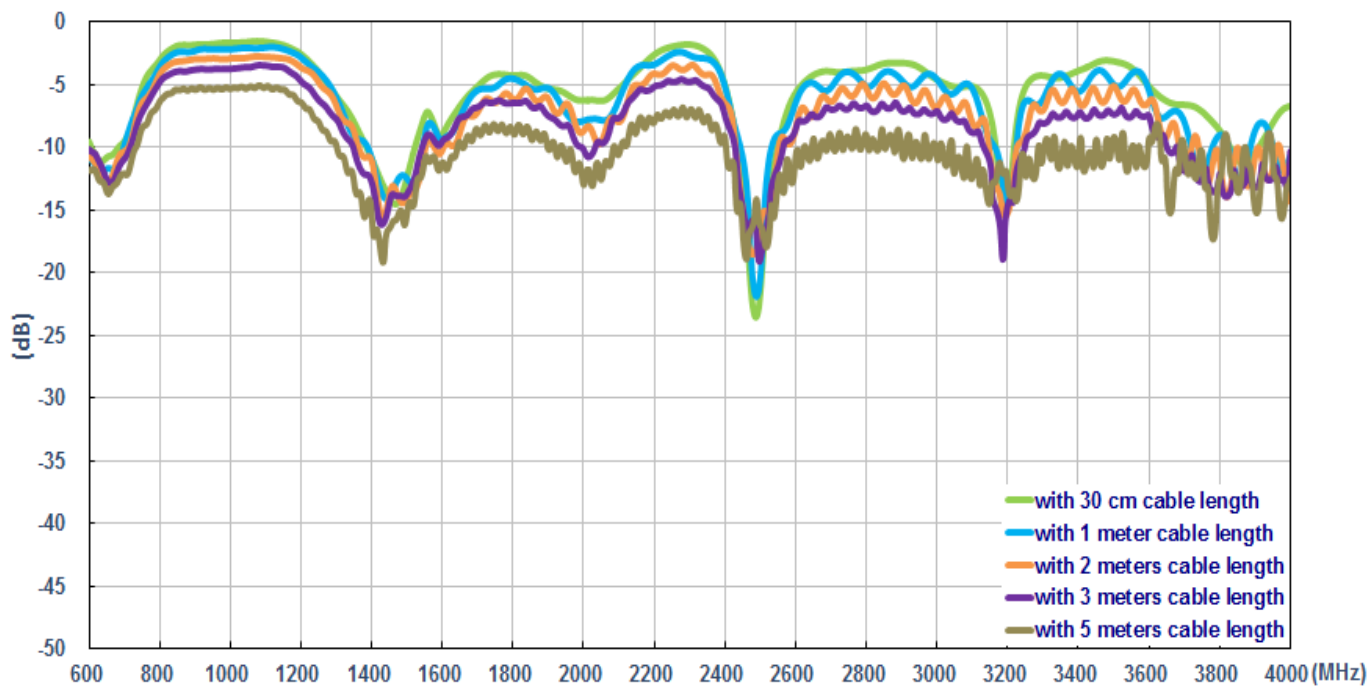

6.3.2. Return loss (MIMO_2 on the glass)

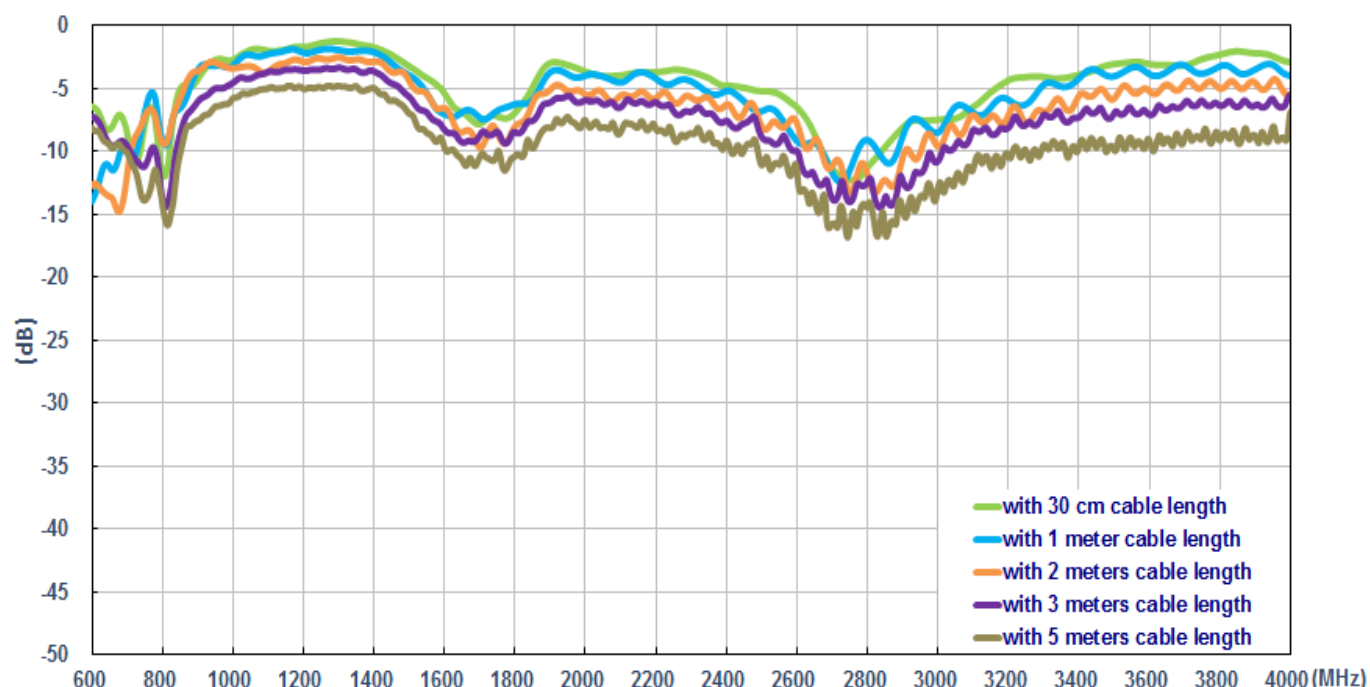



6.3.3. Insertion loss (on the glass)

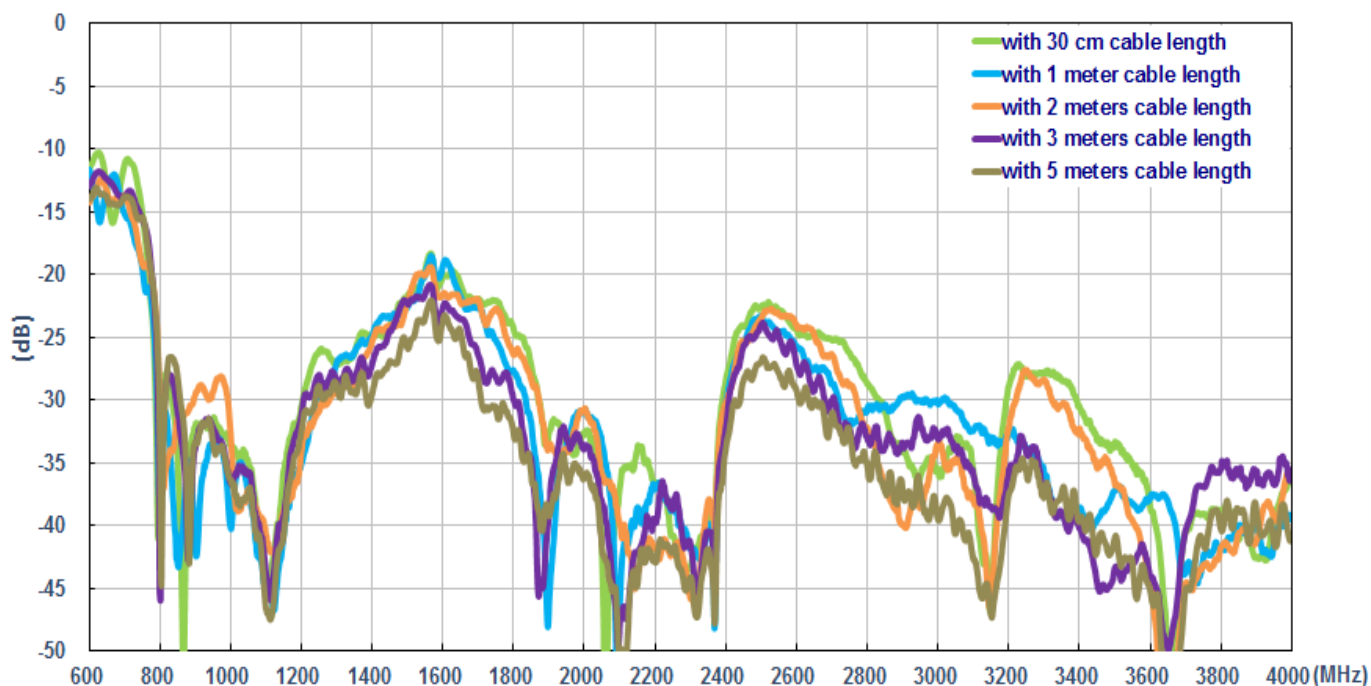

6.3.4. Efficiency (MIMO_1 on the glass)

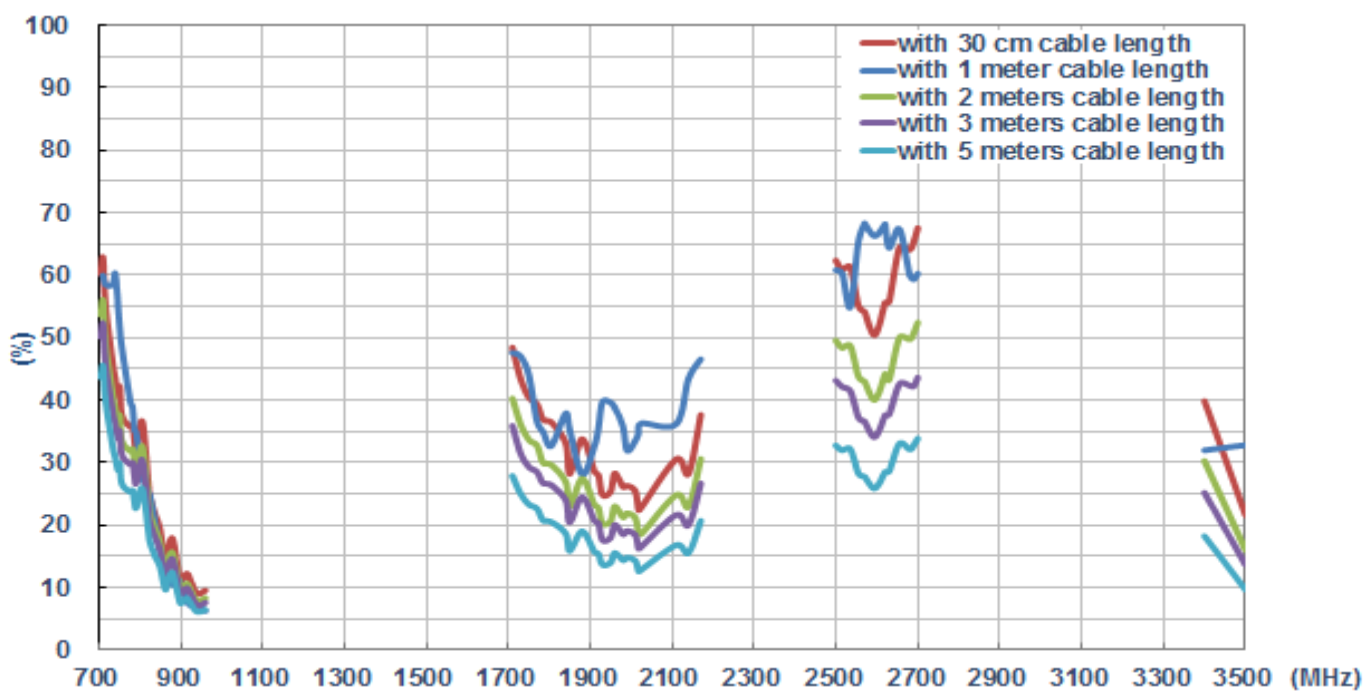



6.3.5. Efficiency (MIMO_2 in on the glass)

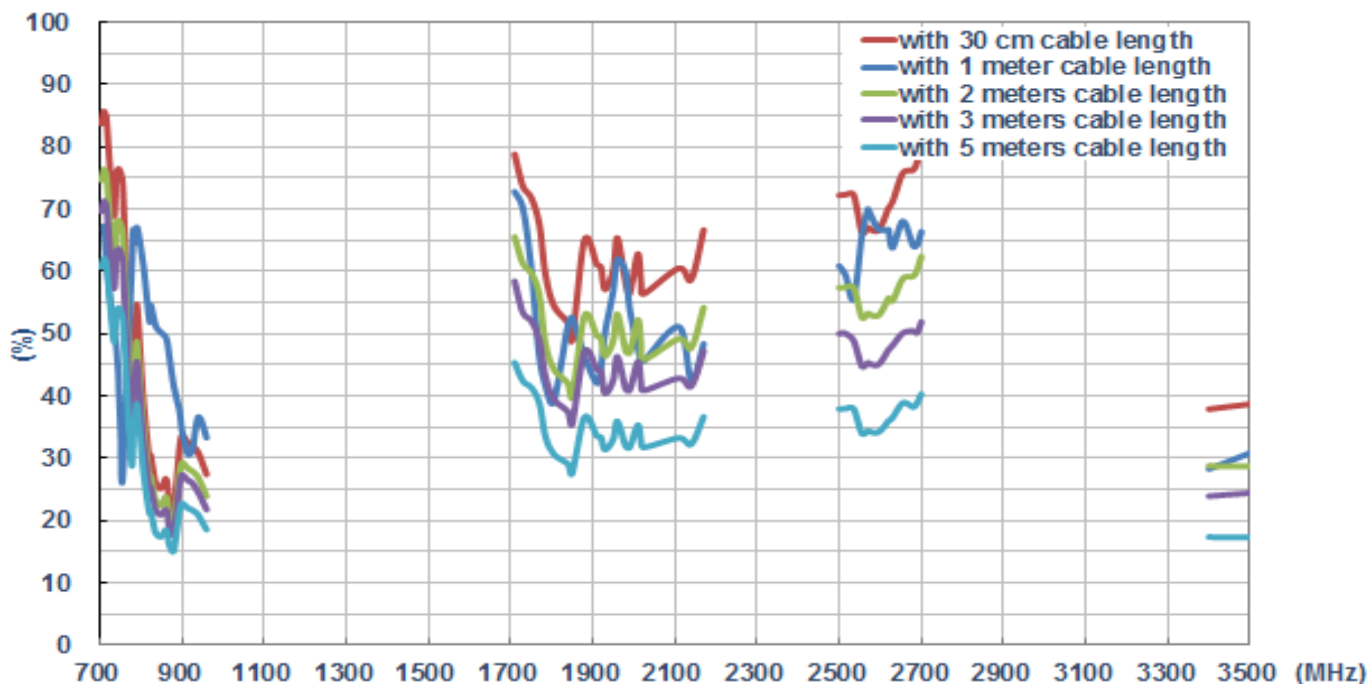

6.3.6. Average Gain (MIMO_1 on the glass)

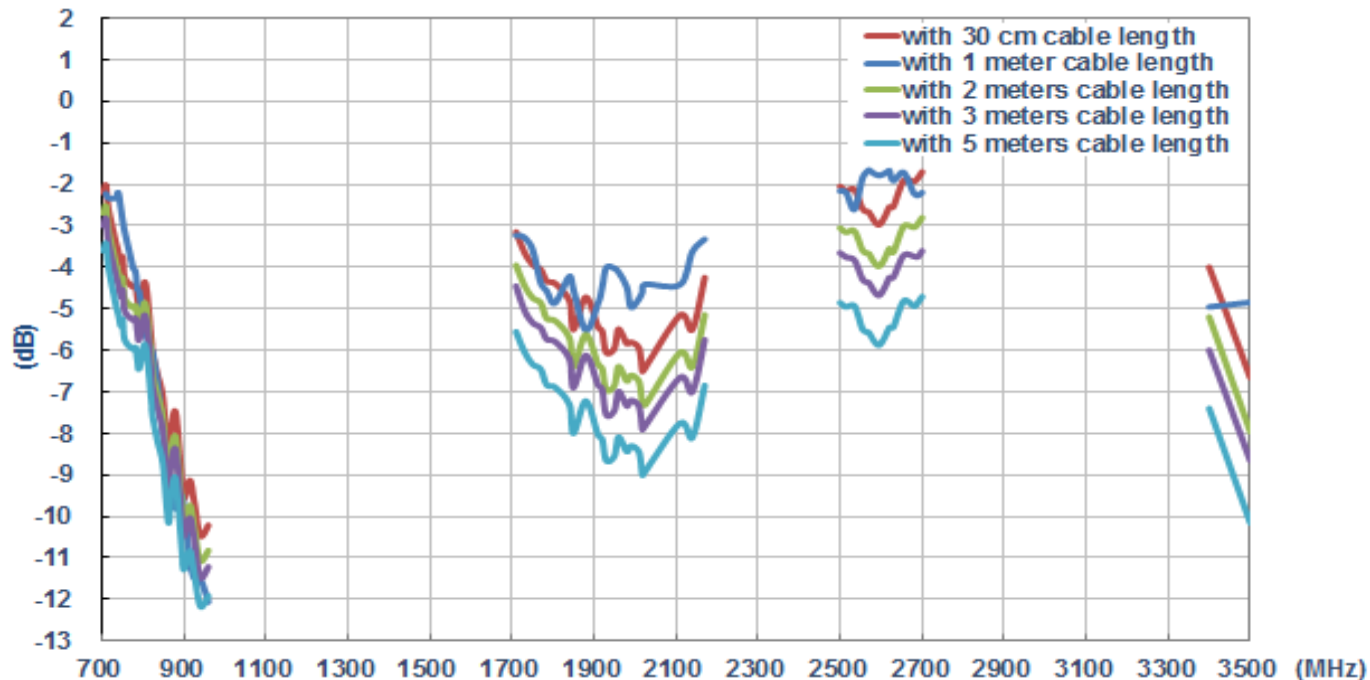



6.3.7. Average Gain (MIMO_2 on the glass)

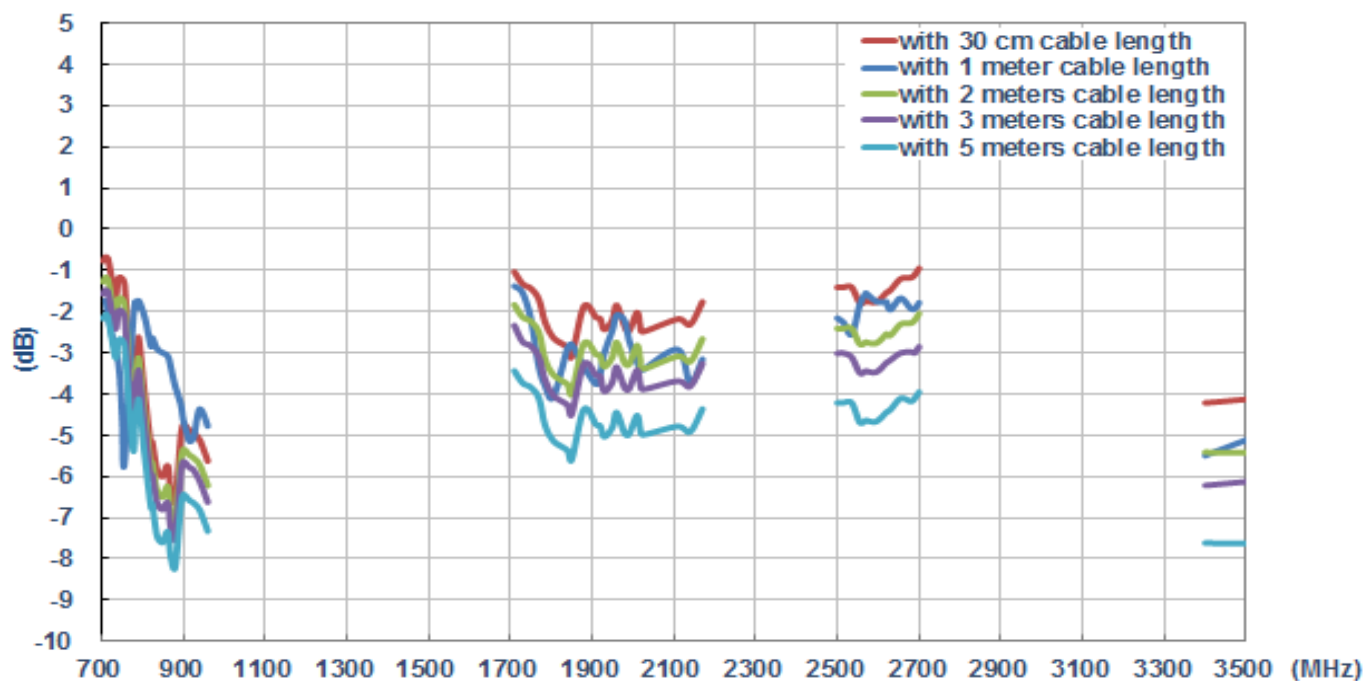

6.3.8. Peak Gain (MIMO_1 on the glass)

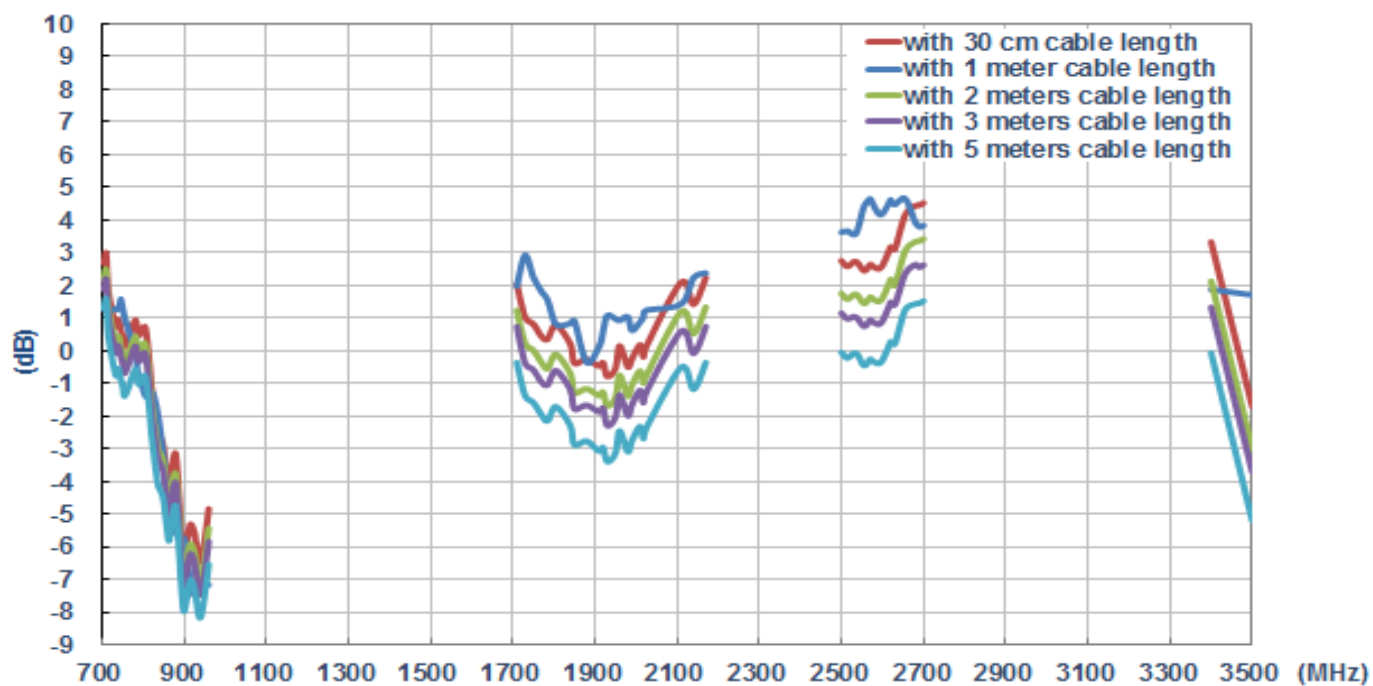



6.3.9. Peak Gain (MIMO_2 on the glass)

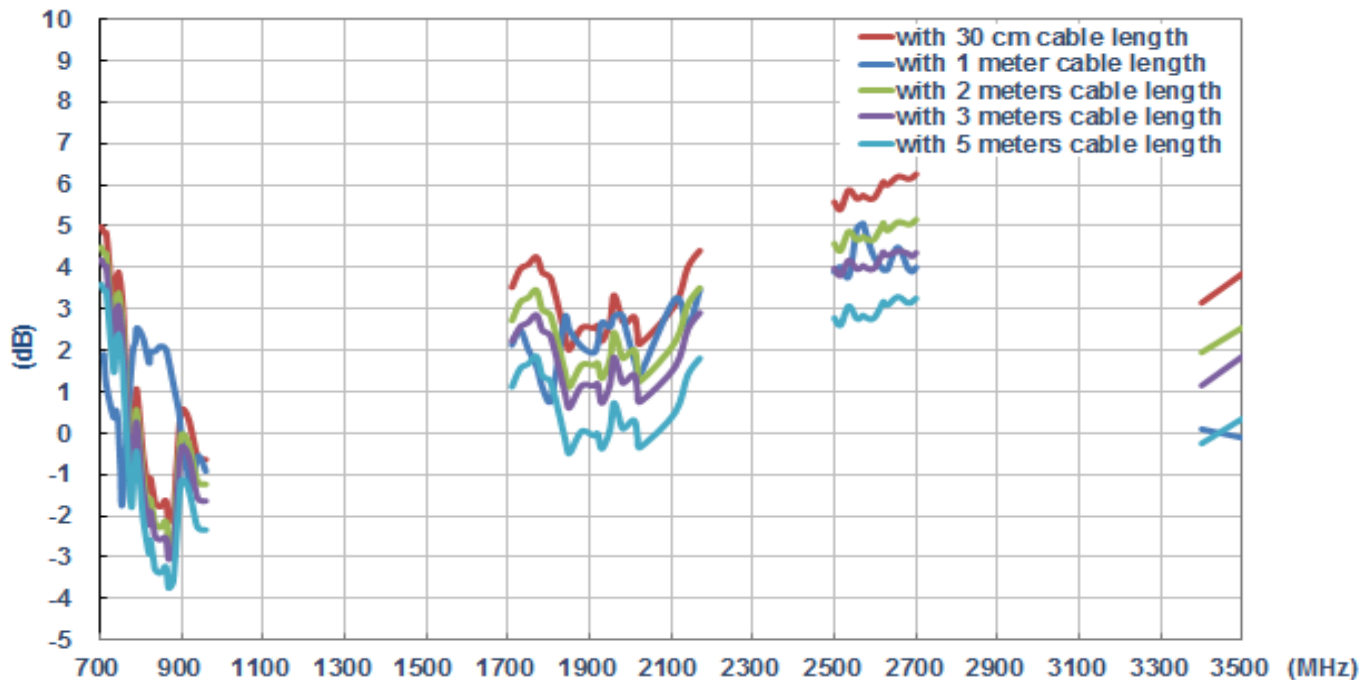

Taoglas makes no warranties based on the accuracy or completeness of the contents of this document and reserves the right to make changes to specifications and product descriptions at any time without notice. Taoglas reserves all rights to this document and the information contained herein.

Reproduction, use or disclosure to third parties without express permission is strictly prohibited.

Copyright © Taoglas Ltd.

X-ON Electronics

Largest Supplier of Electrical and Electronic Components

Click to view similar products for [Antennas](#) category:

Click to view products by [Taoglas](#) manufacturer:

Other Similar products are found below :

[GAN30084EU](#) [930-033-R](#) [GW17.07.0250E](#) [1513563-1](#) [EXE902SM](#) [APAMPG-117](#) [MAF94383](#) [W3908B0100](#) [W6102B0100](#) [YE572113-30RSMM](#) [108-00014-50](#) [66089-2406](#) [A09-F8NF-M](#) [A09-F5NF-M](#) [RGFRA1903041A1T](#) [W3593B0100](#) [W3921B0100](#) [SIMNA-868](#) [SIMNA-915](#) [SIMNA-433](#) [W1044](#) [W1049B090](#) [A75-001](#) [WTL2449CQ1-FRSMM](#) [CPL9C](#) [EXB148BN](#) [0600-00060](#) [TRA9020S3PBN-001](#) [GD5W-28P-NF](#) [MA9-7N](#) [GD53-25](#) [GD5W-21P-NF](#) [C37](#) [MAF94051](#) [MA9-5N](#) [EXD420PL](#) [B1322NR](#) [QWFTB120](#) [MAF94271](#) [MAF94300](#) [GPSMB301](#) [FG4403](#) [AO-AGSM-OM54](#) [5200232](#) [MIKROE-2349](#) [WCM.01.0111](#) [MIKROE-2393](#) [MIKROE-2352](#) [MIKROE-2350](#) [MAF94153](#)