



TAOGLAS®



Datasheet

MA284 4 in 1 Adhesive Mount

Part No:
MA284.LBIC.001

Description:

MA284 Adhesive Mount 4in1 Combination
GNSS, 2* LTE MIMO & Wi-Fi Low Profile Antenna

Features:

GPS/ GLONASS/BeiDou/Galileo
4G MIMO with fallback to 3G/2G
Dual Band Wi-Fi (2.4 & 5.8GHz)
Robust PC/ABS, IP67 Rated Enclosure
1.8~5.5V/30dB LNA
Cables: 2m RG-174 & 2m Low Loss TGC-200
Connectors: SMA(M) & RP-SMA(M) for Wi-Fi
Cables & Connectors Fully Customizable
Dimensions: 151.8 * 59 * 13mm
RoHS & REACH Compliant

1. Introduction	3
2. Specifications	4
3. Antenna Characteristics	9
4. 2D Radiation Patterns	19
5. 3D Radiation Patterns	29
6. Mechanical Drawing	34
7. Packaging	35
8. Application Notes	36
9. Vibration Test	42
10. Mechanical Shock Test	51
11. Drop Test	56
Changelog	65

Taoglas makes no warranties based on the accuracy or completeness of the contents of this document and reserves the right to make changes to specifications and product descriptions at any time without notice. Taoglas reserves all rights to this document and the information contained herein. Reproduction, use or disclosure to third parties without express permission is strictly prohibited.



1. Introduction



The Taoglas MA284 is one of the smallest 4-in-1 low profile, adhesive mount, combination antennas on the market. Comprising of GNSS, 2*Cellular MIMO and dual band Wi-Fi, this unique antenna delivers powerful 4G antenna technology, that includes backward compatibility to work at most worldwide 3G and 2G bands. The cellular antenna can also operate at some 5G bands. Coupled with GPS, GLONASS & BeiDou and 2.4/5.8GHz Wi-Fi, it is ideal for next generation, multiple wireless technology systems, such as vehicle telematics and applications that require highly sophisticated antennas for real-time streaming demanding high-speed video uplink and downlink into the cabin of the vehicle. These challenges are resolved by the highly efficient, high gain antennas, with high isolation, all of which is necessary to achieve the required signal to noise ratio and throughput.

The LTE & Wi-Fi antennas have an omnidirectional radiation pattern and the robust PC/ABS enclosure is fully IP67 waterproof and design for use in the harshest of environments. The GNSS antenna has been carefully designed to work equally well on both GPS/GALILEO and GLONASS bands, leading to higher location accuracy and stability of tracking in urban environments.

Typical Applications Include:

- Next Generation OEM Automotive Connectivity
- Multimedia, Navigation and Telematics Systems
- V2V, V2X and Fleet Management Applications
- Real-time HD Video Streaming
- Digital Signage and Remote Monitoring
- First Net Responder Routers

Cable length and connector types are fully customizable. Contact your regional Taoglas customer support team to request these services or additional support to integrate and test this antenna's performance in your device.

2. Specifications

GNSS Frequency Bands Covered

GPS/QZSS	L1 1575.42MHz	L2 1227.6MHz	L5 1176.45MHz	L6 1278.75MHz			
	■	□	□	□			
GLONASS	L5R 1176.45MHz	L3PT 1201.5MHz	L2PT 1246MHz	L1CR 1575.42MHz	L1PT 1602MHz		
	□	□	□	■	■		
Galileo	E5a 1176.45MHz	E5b 1201.5MHz	E4 1215MHz	E3 1256MHz	E6 1278.75MHz	E2 1561MHz	L1 1575.42MHz
	□	□	□	□	□	■	■
BeiDou	B1 1561MHz	B2 1207.14MHz	B3 1268.52MHz				
	■	□	□				
Compass	E5B(B2)/ E6(B3) 1268.56MHz	E2(B1) 1561MHz					
	□	■					
SBAS	Omnistar 1542.5MHz	WAAS/EGN OS 1575.42MHz					
	□	■					

Cellular Antenna										
Band	LTE700	GSM850	GSM900	5G Bands 74,75,76	DCS	PCS	UMTS1	LTE2600	5G Bands 42,43,48,78	
Frequency (MHz)	698~803	824~894	880~960	1427-1518	1710~1880	1850~1990	1920~2170	2300~2690	3300-3800	
Efficiency (%)										
MIMO1	0.3m	56.88	64.17	68.41	67.53	62.92	60.73	62.35	61.23	42.11
	1m	53.80	61.28	65.33	63.02	57.39	55.39	57.31	55.84	37.17
	2m	50.21	56.24	59.59	56.3	51.13	48.72	50.18	48.36	31.35
	3m	46.49	52.16	55.25	50.06	45.48	43.10	44.40	42.01	26.38
	5m	43.05	48.38	51.24	44.49	40.44	38.14	39.28	36.50	22.19
MIMO2	0.3m	65.41	53.23	49.54	43.20	74.95	76.59	79.35	75.16	60.02
	1m	61.77	50.84	47.31	40.32	68.35	69.85	72.93	68.55	52.87
	2m	57.64	46.66	43.15	36.02	60.88	61.42	63.88	59.35	44.8
	3m	53.46	43.27	40.02	32.03	54.16	54.35	56.50	51.56	37.72
	5m	49.59	40.12	37.12	28.47	48.16	48.09	49.98	44.80	31.74
Average Gain (dB)										
MIMO1	0.3m	-2.45	-1.93	-1.65	-1.71	-2.01	-2.17	-2.05	-2.13	-3.79
	1m	-2.69	-2.13	-1.85	-2.01	-2.41	-2.57	-2.42	-2.53	-4.33
	2m	-2.99	-2.50	-2.25	-2.49	-2.91	-3.12	-2.99	-3.16	-5.07
	3m	-3.33	-2.83	-2.58	-3.01	-3.42	-3.66	-3.53	-3.77	-5.82
	5m	-3.66	-3.15	-2.90	-3.52	-3.93	-4.19	-4.06	-4.38	-6.57
MIMO2	0.3m	-1.84	-2.74	-3.05	-3.66	-1.25	-1.16	-1.00	-1.24	-2.22
	1m	-2.09	-2.94	-3.25	-3.96	-1.65	-1.56	-1.37	-1.64	-2.77
	2m	-2.39	-3.31	-3.65	-4.45	-2.16	-2.12	-1.95	-2.27	-3.49
	3m	-2.72	-3.64	-3.98	-4.96	-2.66	-2.65	-2.48	-2.88	-4.24
	5m	-3.05	-3.97	-4.30	-5.48	-3.17	-3.18	-3.01	-3.49	-4.99
Peak Gain (dBi)										
MIMO1	0.3m	2.49	2.84	2.58	2.58	4.05	4.63	5.01	3.85	1.02
	1m	2.29	2.64	2.38	2.28	3.65	4.23	4.71	3.45	0.49
	2m	1.99	2.34	1.98	1.79	3.15	3.63	4.11	2.85	-0.25
	3m	1.61	1.94	1.68	1.29	2.55	3.13	3.51	2.25	-1
	5m	1.31	1.54	1.38	0.76	1.95	2.63	2.91	1.65	-1.75
MIMO2	0.3m	2.98	3.35	2.83	0.64	4.69	3.58	4.20	4.22	2.39
	1m	2.68	3.15	2.63	0.34	4.29	3.18	3.90	3.82	1.84
	2m	2.38	2.75	2.23	-0.15	3.79	2.58	3.30	3.22	1.12
	3m	2.08	2.45	1.93	-0.66	3.29	2.08	2.70	2.62	0.37
	5m	1.78	2.15	1.63	-1.17	2.79	1.58	2.10	2.02	-0.37
Impedance		50 Ω								
Polarization		Linear								

Wi-Fi Antenna (2.4GHz/5.8GHz)		
Frequency (MHz)	2400~2500	4900~5850
Efficiency (%)		
0.3m	56.61	64.55
1m	51.63	55.53
2m	47.11	47.78
3m	41.01	38.77
5m	31.11	25.47
Peak Gain (dBi)		
0.3m	2.12	4.10
1m	1.72	3.44
2m	1.12	2.53
3m	0.52	1.62
5m	-0.68	-0.21
Average Gain (dB)		
0.3m	-2.21	-0.87
1m	-2.61	-1.47
2m	-3.01	-2.07
3m	-3.61	-2.87
5m	-4.81	-4.67
Impedance	50 Ω	
Return loss	< -6 dB	
Polarization	Linear	

GNSS Antenna			
Frequency	BeiDou: 1561.098 ± 2.046MHz. GPS: 1575.42 ± 1.023MHz GLONASS: 1602 ± 5MHz		
Bandwidth	12.5 MHz min		
Return Loss	<-10 dB		
Return loss (GPS L1 GLONASS L1)	< -10 dB		
Passive Gain at Zenith (GPS L1 and GLONASS L1)	+2.3 dBi typ.		
Polarization	RHCP		
Impedance	50 Ω		
LNA Out-band Attenuation	fo = 1575.42MHz fo ± 50 MHz 8dB Min. fo ± 100 MHz 22dB Min. fo ± 150 MHz 26dB Min.		
Input Voltage	Min:1.8V	Typ. 3.0V	Max: 5.5V
Total Gain @ Zenith	25.3dBi	25.5dBi	25.3dBi
Current Consumption	5 mA	10 mA	23 mA
Noise Figure	3.0 dB	2.8 dB	3.0 dB
Mechanical			
Dimensions	151.8*59*13 mm		
Cable	LTE MIMO1/ MIMO2: 2000mm TGC200 WI-FI: 2000mm TGC200 GNSS: 2000mm RG174		
Connector	LTE: SMA Plug WI-FI: RP SMA Plug GNSS: SMA Plug		
Casing	PC+ABS		
Adhesive	3M 9448HK + CR4305		
Sealant	Rubber Stopper		
Weight	180 g (Not Including Cable And Package)		
Environmental			
Protection	IP67		
Temperature Range	-40°C to +85°C		
Thermal Shock	100 cycles -40°C to +85°C		
Humidity	Non-condensing 65°C 95% RH		
Cable Pull	RG174 - 4 Kg / TGC200 - 9Kg		

5G/4G Bands			
Band Number	5G NR / FR1 / LTE / LTE-Advanced / WCDMA / HSPA / HSPA+ / TD-SCDMA		
	Uplink	Downlink	Covered
1	UL: 1920 to 1980	DL: 2110 to 2170	✓
2	UL: 1850 to 1910	DL: 1930 to 1990	✓
3	UL: 1710 to 1785	DL: 1805 to 1880	✓
4	UL: 1710 to 1755	DL: 2110 to 2155	✓
5	UL: 824 to 849	DL: 869 to 894	✓
7	UL: 2500 to 2570	DL: 2620 to 2690	✓
8	UL: 880 to 915	DL: 925 to 960	✓
9	UL: 1749.9 to 1784.9	DL: 1844.9 to 1879.9	✓
11	UL: 1427.9 to 1447.9	DL: 1475.9 to 1495.9	✓
12	UL: 699 to 716	DL: 729 to 746	✓
13	UL: 777 to 787	DL: 746 to 756	✓
14	UL: 788 to 798	DL: 758 to 768	✓
17	UL: 704 to 716	DL: 734 to 746 (LTE only)	✓
18	UL: 815 to 830	DL: 860 to 875 (LTE only)	✓
19	UL: 830 to 845	DL: 875 to 890	✓
20	UL: 832 to 862	DL: 791 to 821	✓
21	UL: 1447.9 to 1462.9	DL: 1495.9 to 1510.9	✓
22	UL: 3410 to 3490	DL: 3510 to 3590	✓
23	UL: 2000 to 2020	DL: 2180 to 2200 (LTE only)	✓
24	UL: 1625.5 to 1660.5	DL: 1525 to 1559 (LTE only)	✓
25	UL: 1850 to 1915	DL: 1930 to 1995	✓
26	UL: 814 to 849	DL: 859 to 894	✓
27	UL: 807 to 824	DL: 852 to 869 (LTE only)	✓
28	UL: 703 to 748	DL: 758 to 803 (LTE only)	✓
29	UL: -	DL: 717 to 728 (LTE only)	✓
30	UL: 2305 to 2315	DL: 2350 to 2360 (LTE only)	✓
31	UL: 452.5 to 457.5	DL: 462.5 to 467.5 (LTE only)	✗
32	UL: -	DL: 1452 - 1496	✓
35		1850 to 1910	✓
38		2570 to 2620	✓
39		1880 to 1920	✓
40		2300 to 2400	✓
41		2496 to 2690	✓
42		3400 to 3600	✓
43		3600 to 3800	✓
48		3550 to 3700	✓
66	UL: 1710-1780	DL: 2110-2200	✓
71		617 to 698	✗
74/75/76		1427 to 1518	✓
78		3300 to 3800	✓
79		4400 to 5000	✗
126		410 to 430	✗

*Measured at 2m cable length

3. Antenna Characteristics

3.1 LTE MIMO 1& 2 Antennas

Return Loss

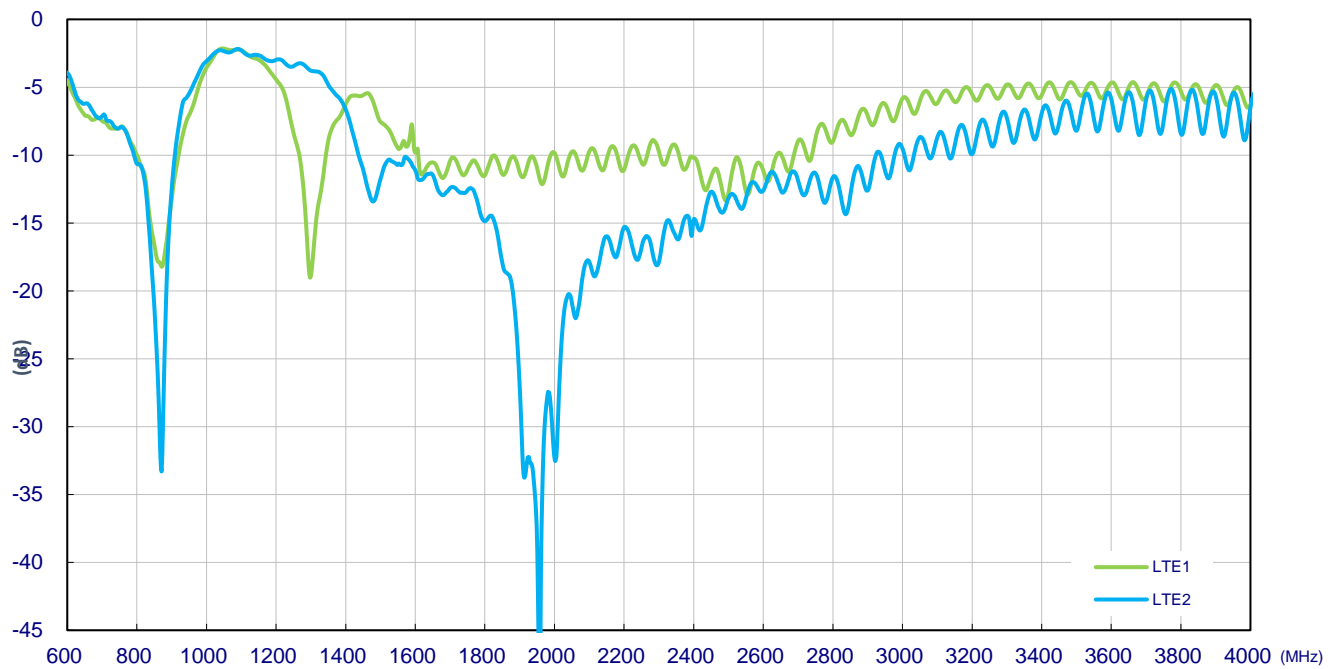

Isolation between LTE and Wi-Fi antenna

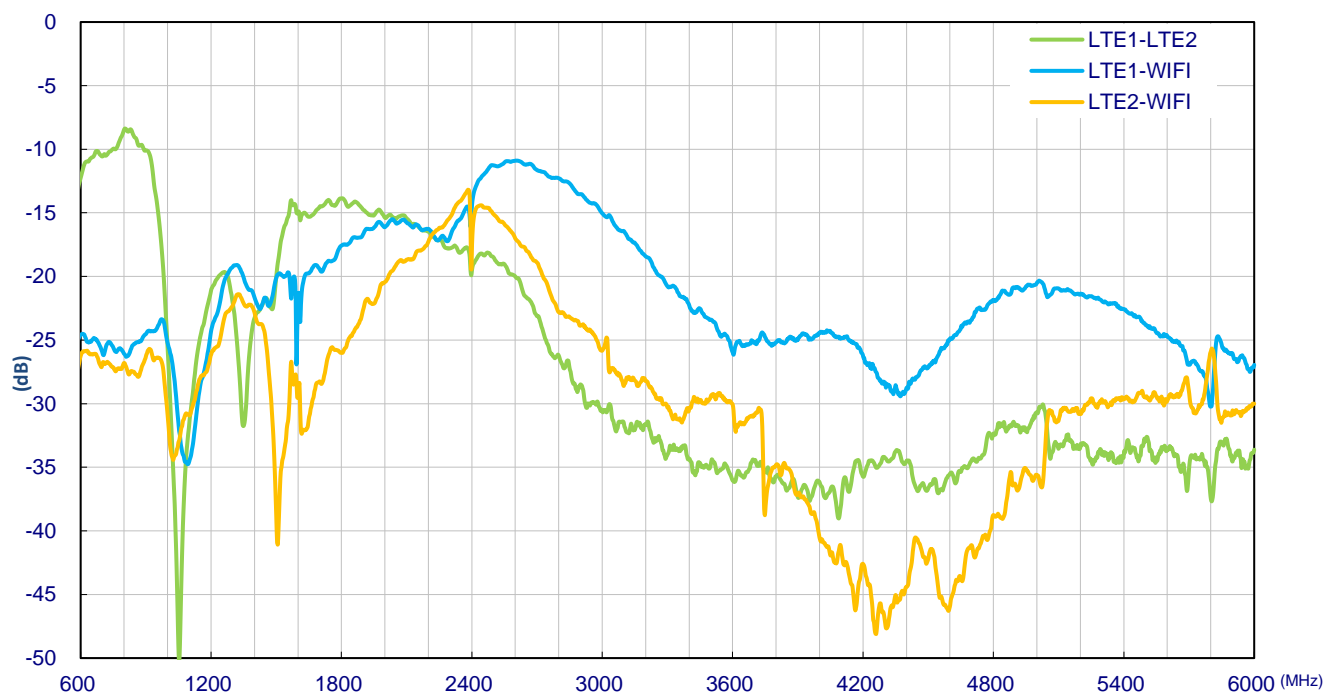

Isolation between LTE and GPS antenna

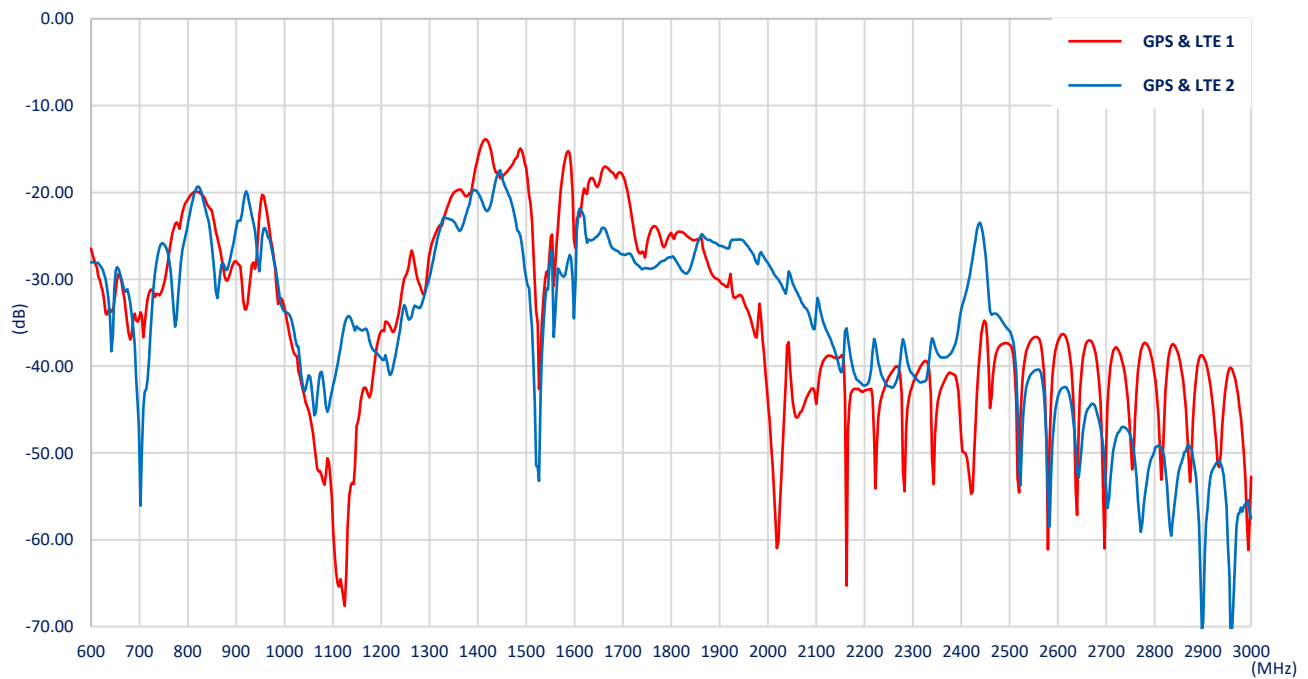

Efficiency

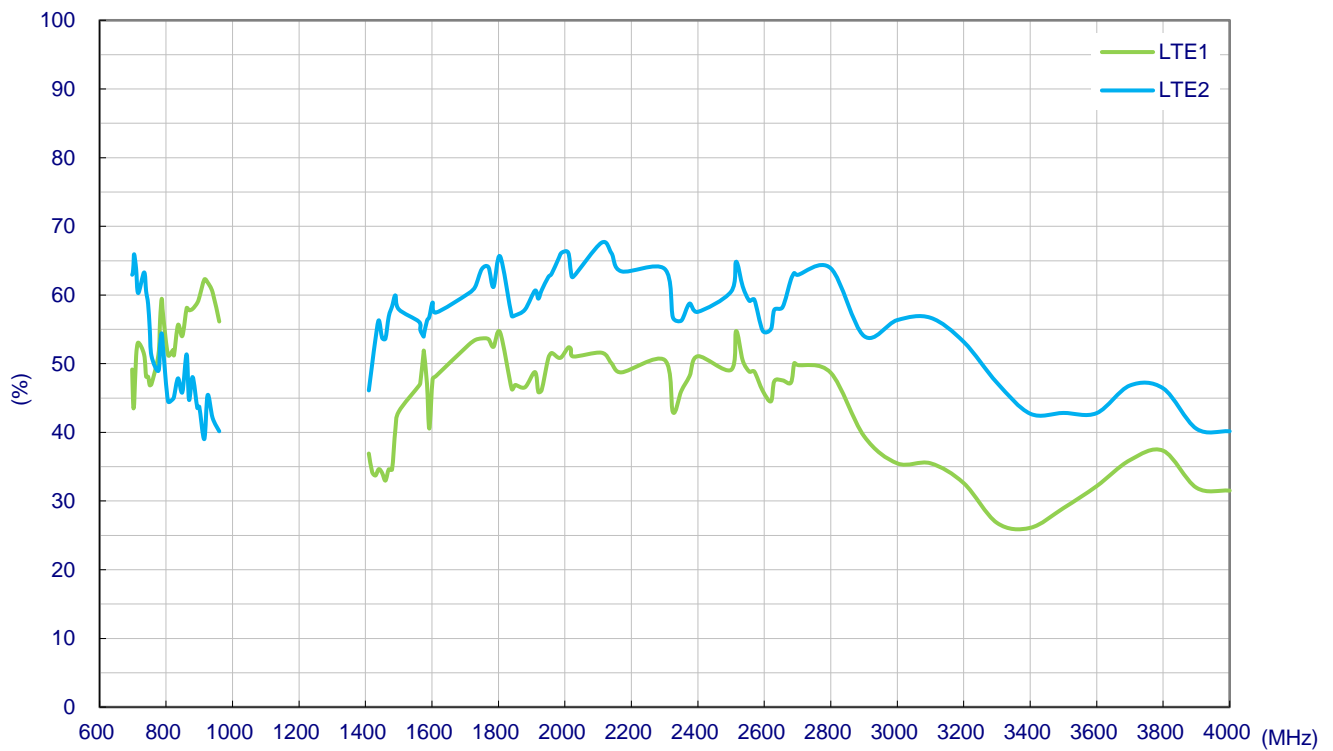

Average Gain

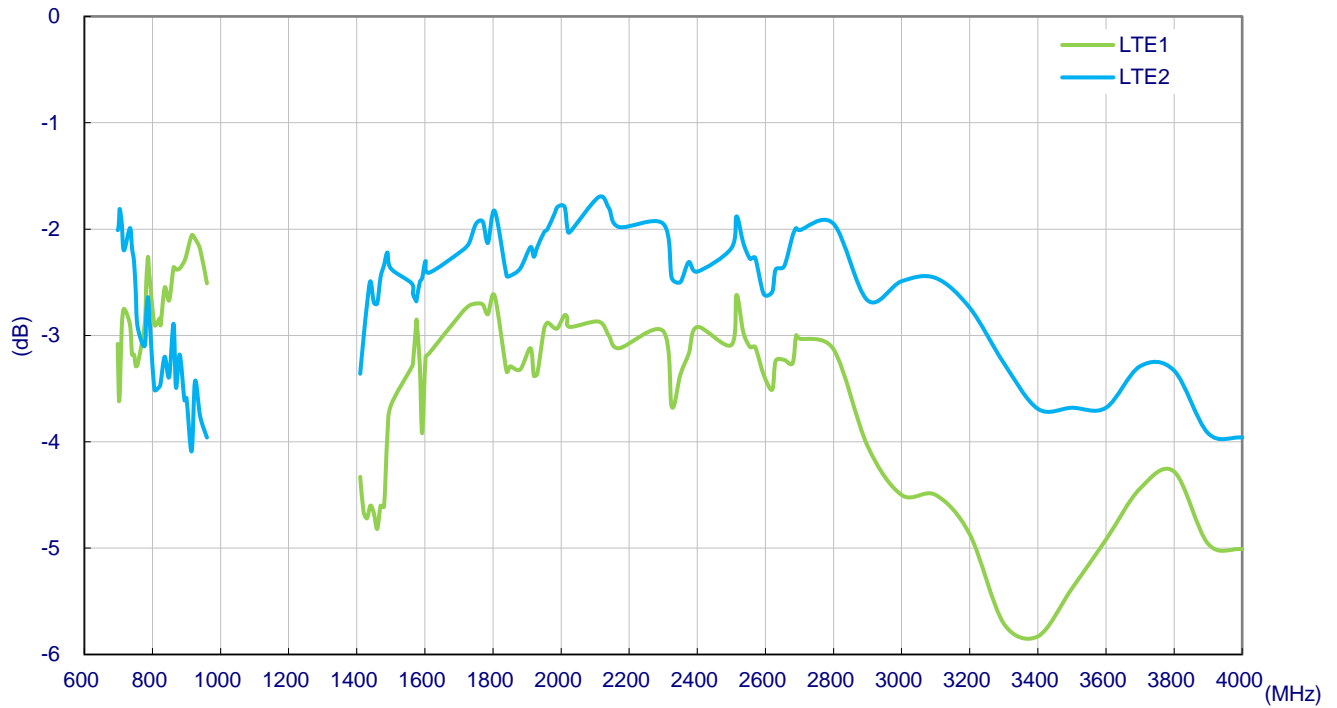

Peak Gain

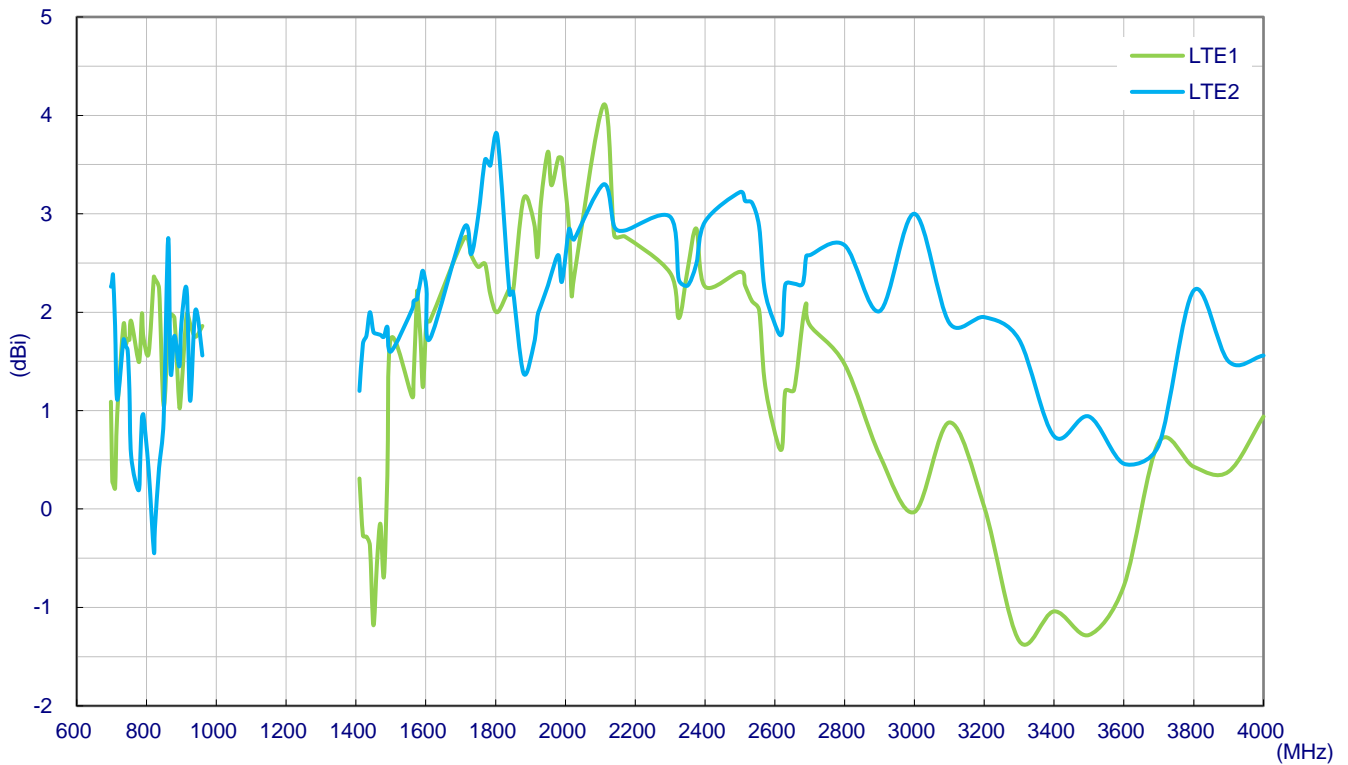

3.2 Wi-Fi Antenna

Return Loss

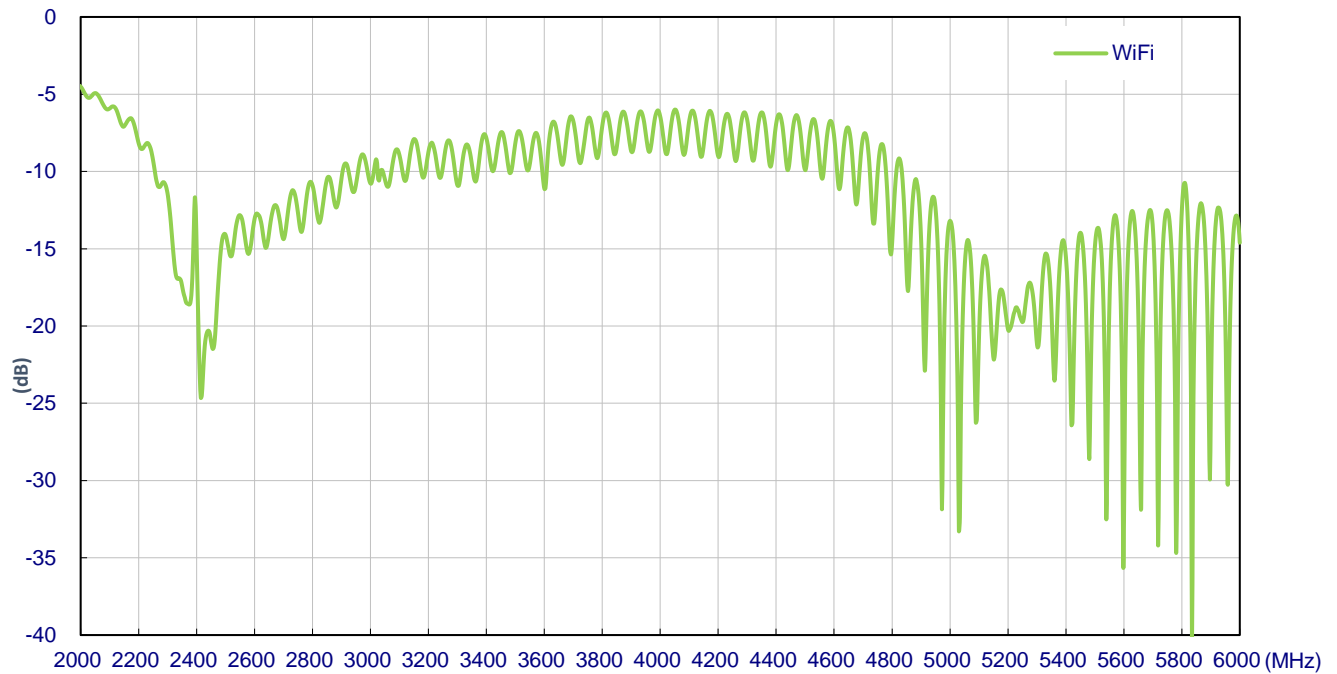

Efficiency

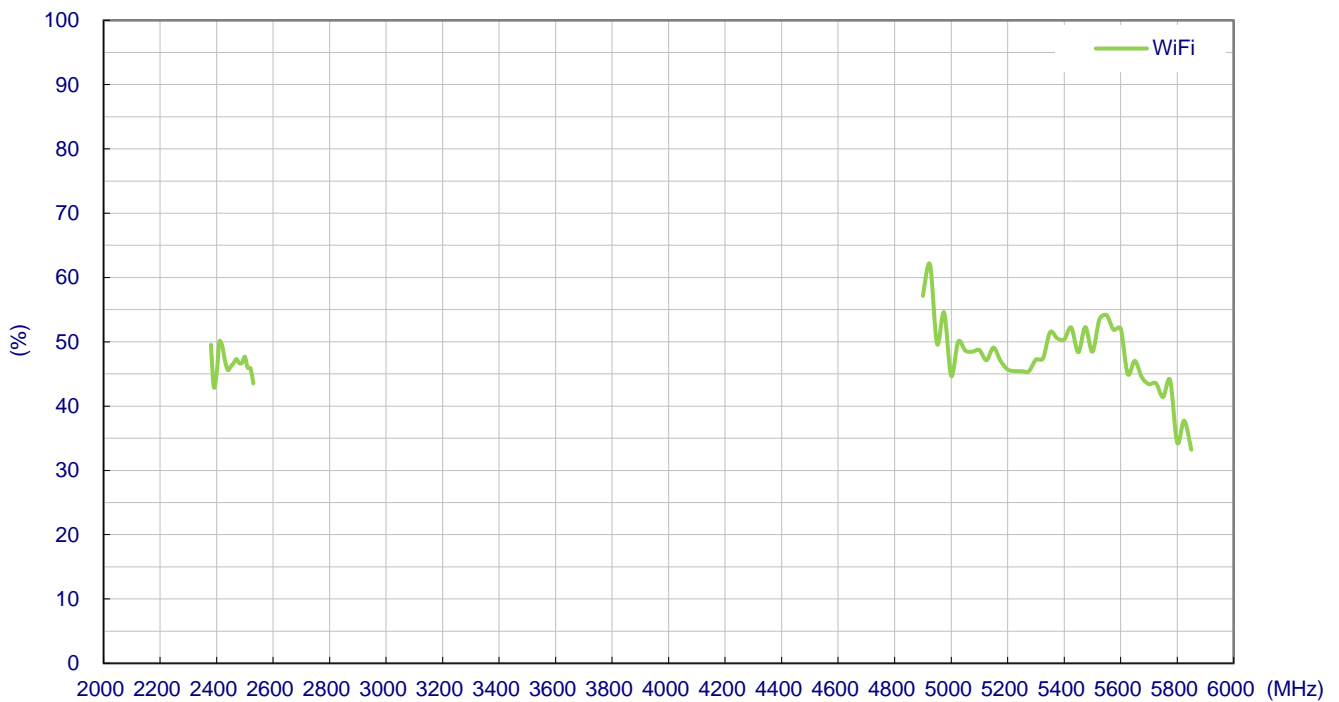

Average Gain

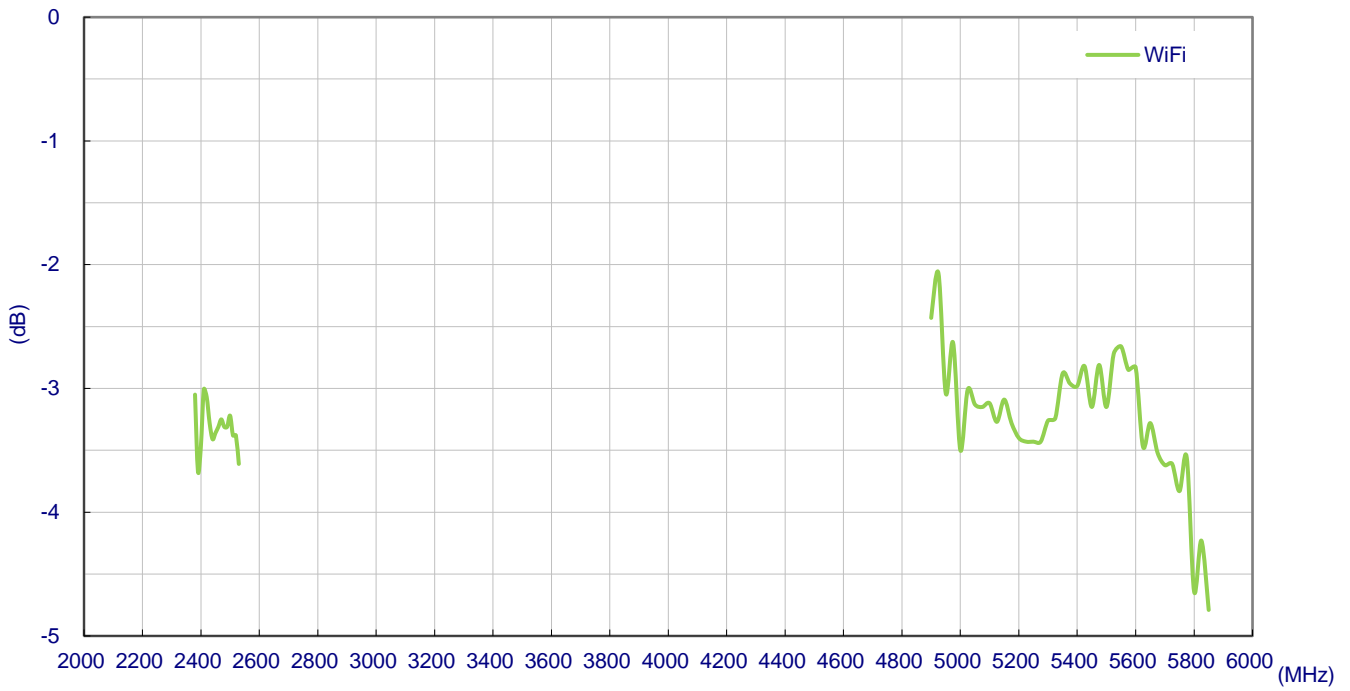

Peak Gain

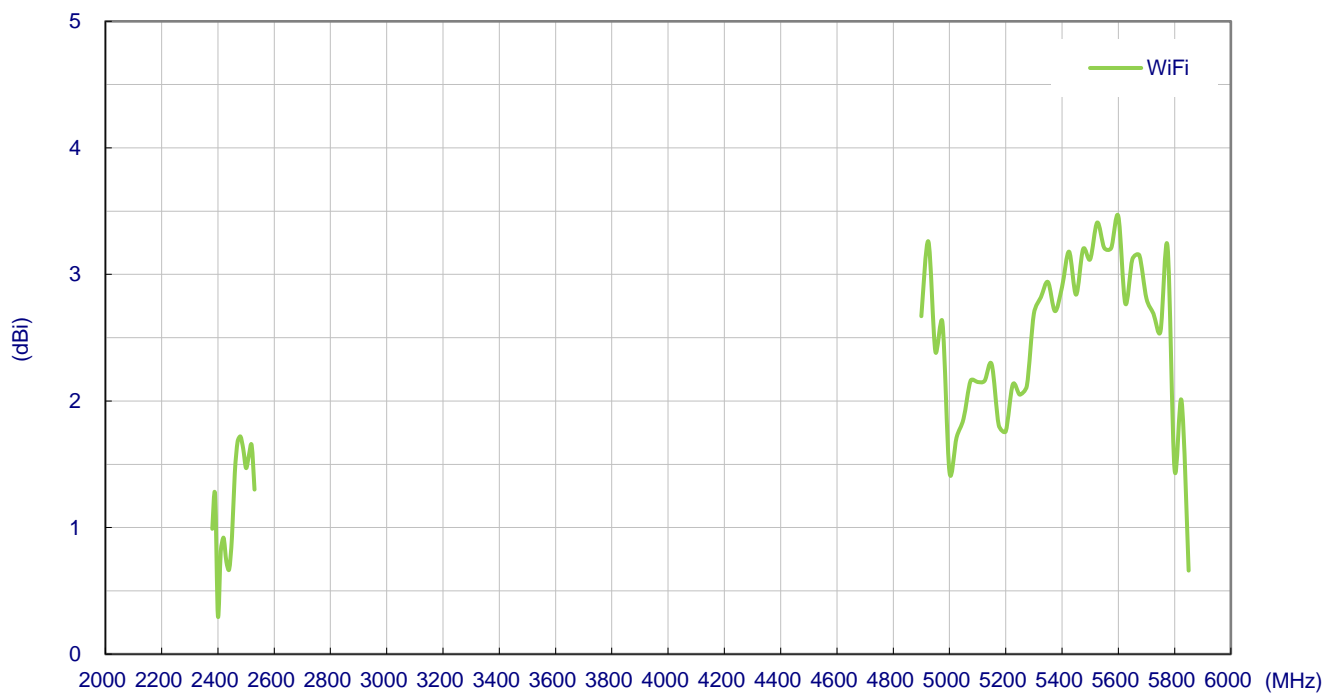

3.3 GNSS Antenna

Block Diagram (Active antenna)

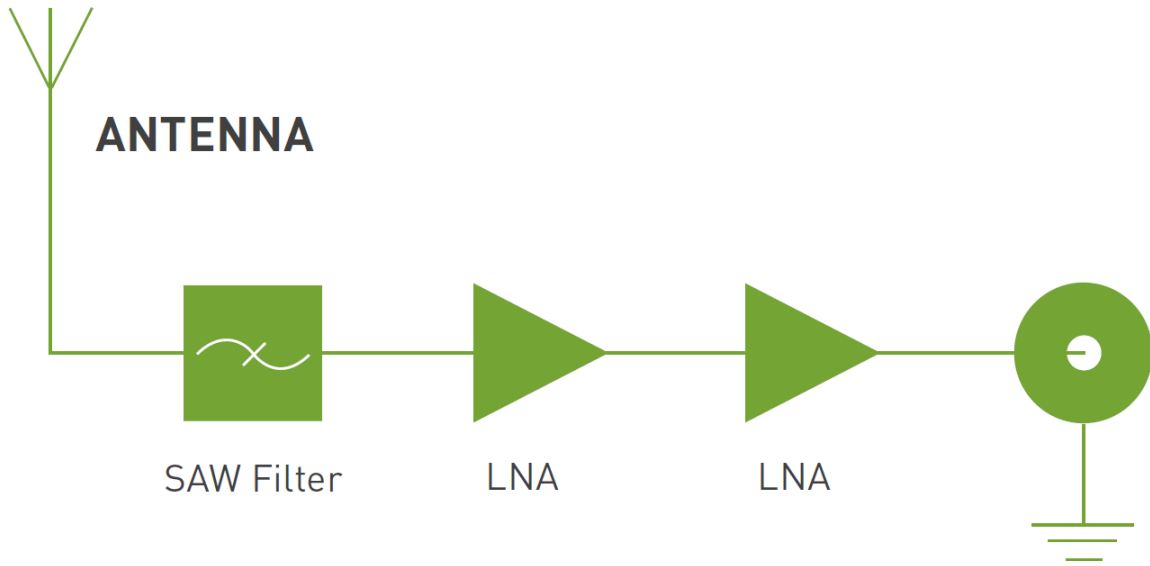

Return Loss

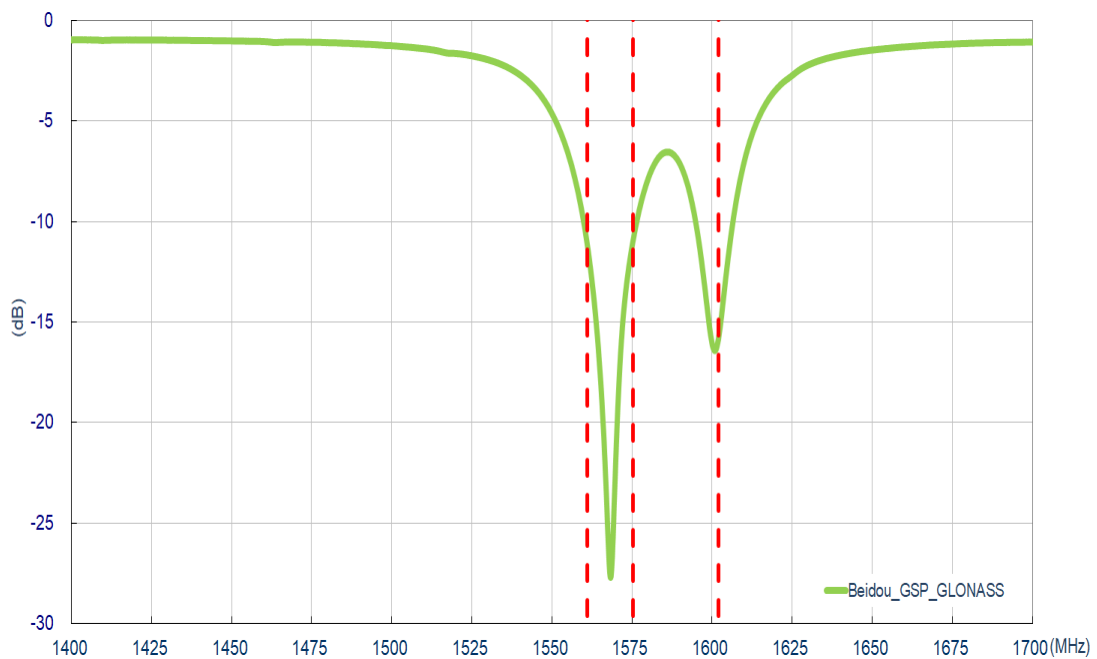

Efficiency

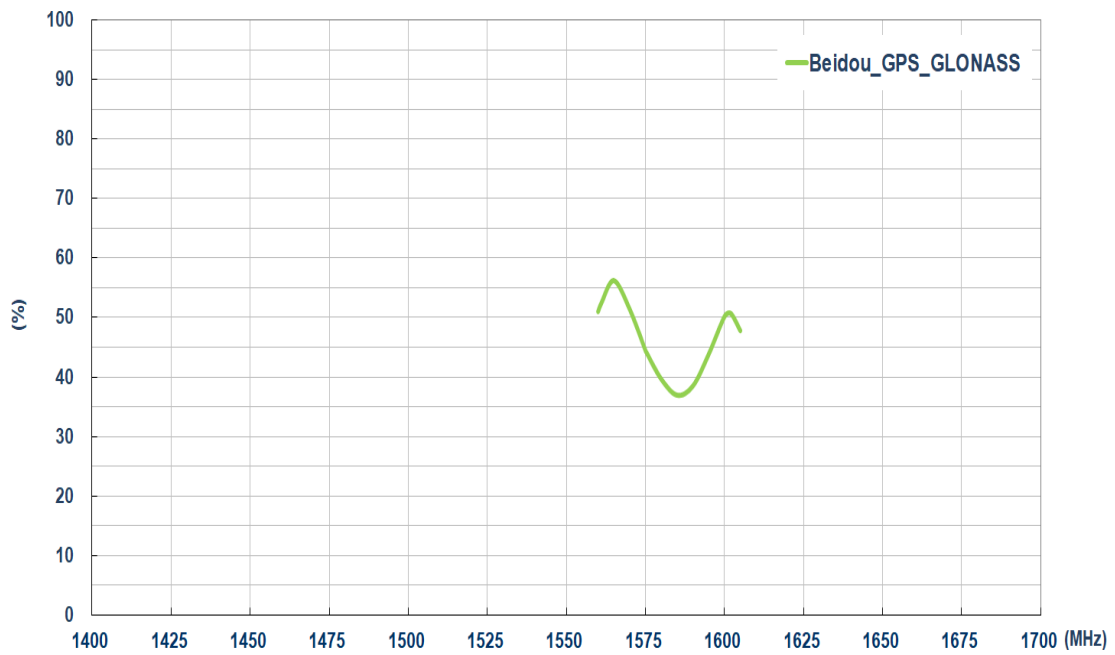

Average Gain

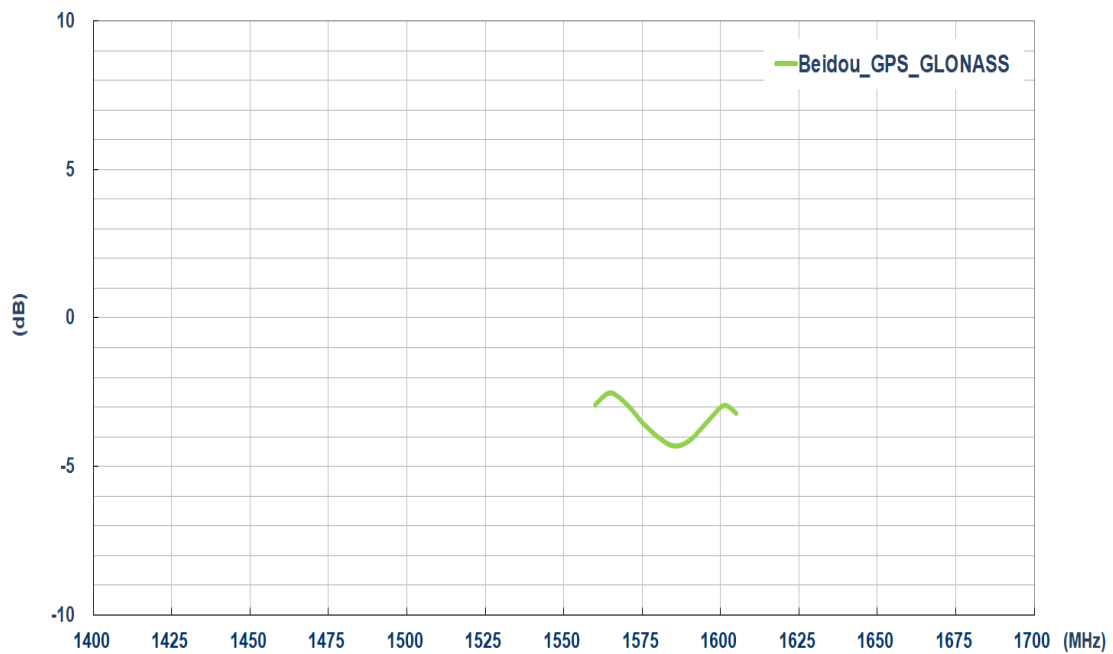

Peak Gain

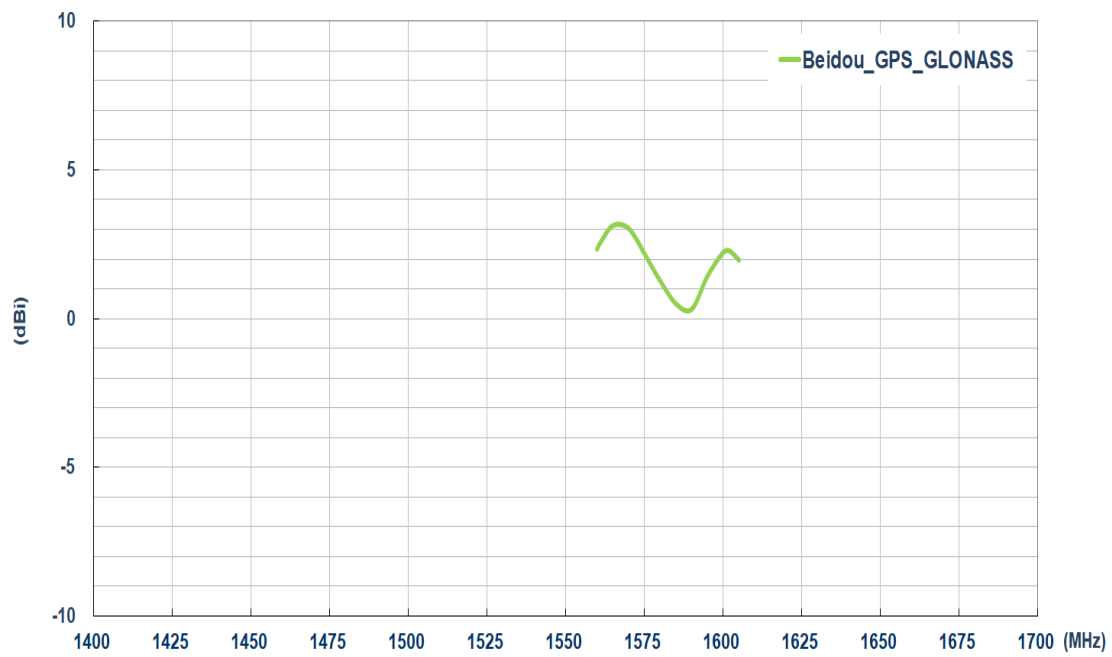

Axial Ratio - XZ

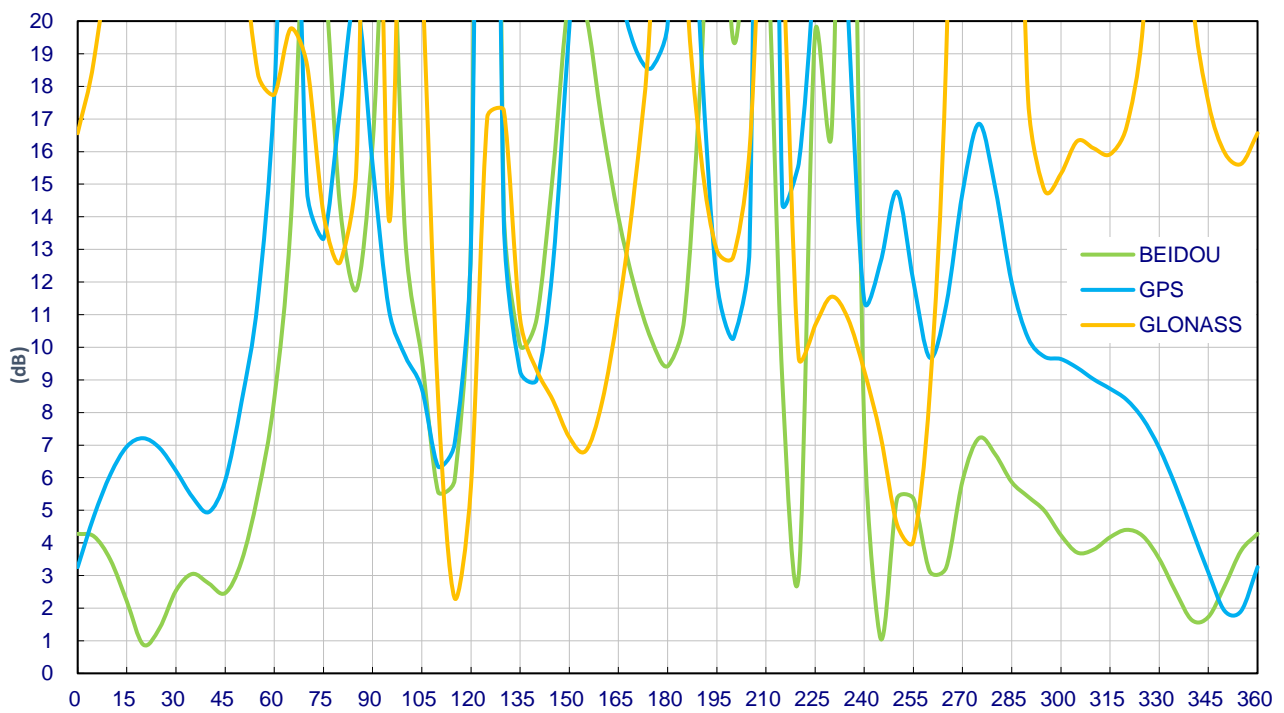

Axial Ratio - YZ

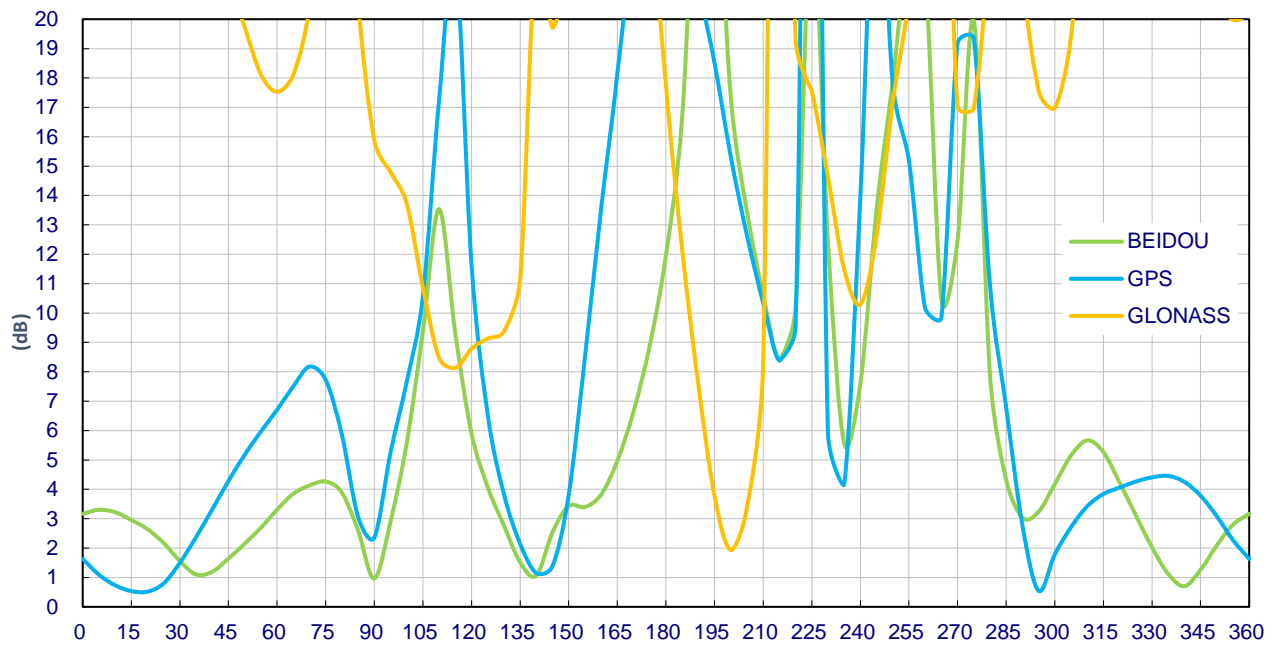

GNSS LNA Gain @3V

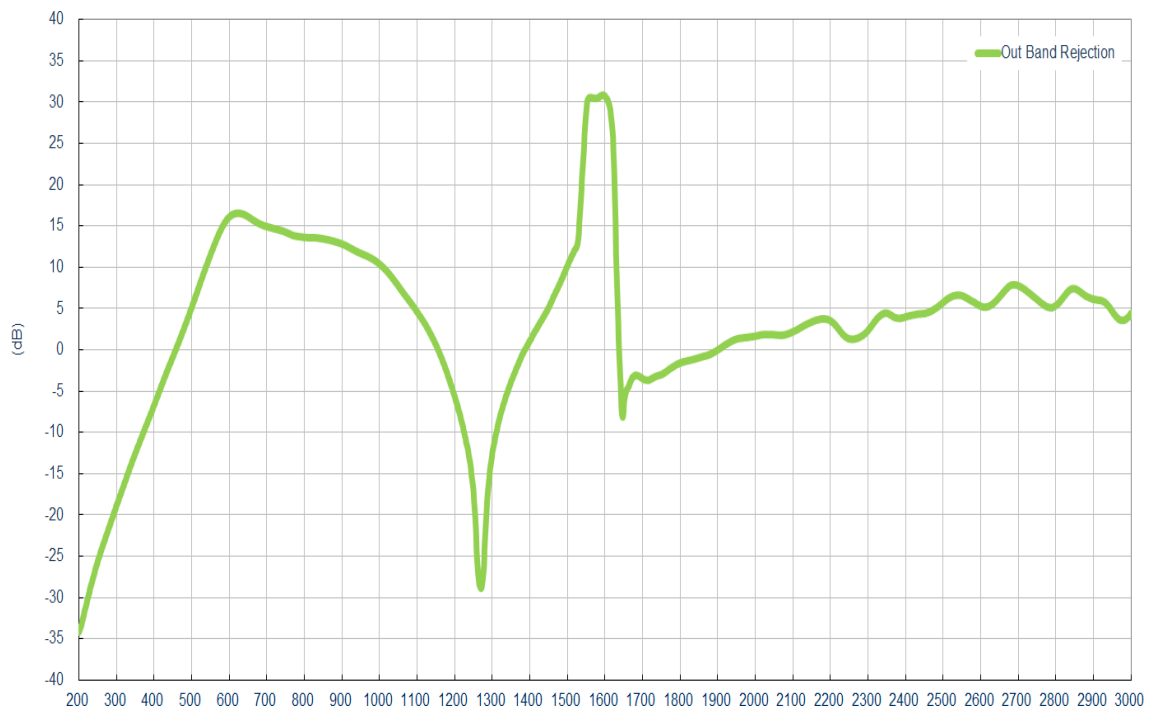

GNSS LNA Gain and Noise Figure @ 3V

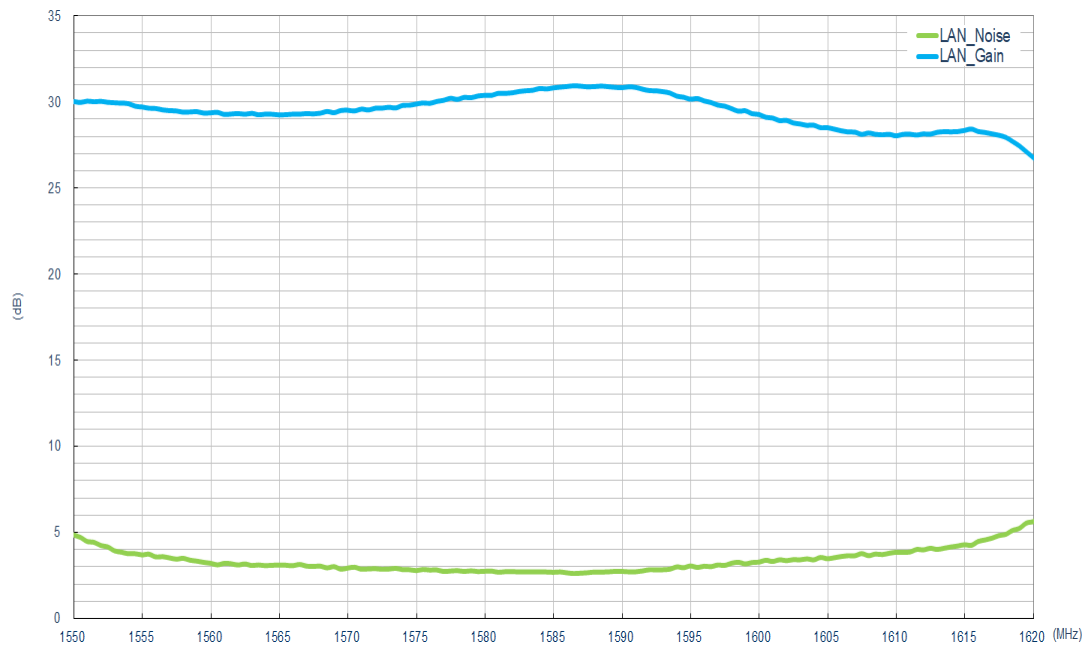

LNA -1dB Compression Test

Parameter	Specification
Frequency	1574~1610 MHz
Outer Band Attenuation	1592±140 MHz 15dB min
Output Impedance	50Ω
Output VSWR	2.0 Max
Pout at 1dB Gain	Typ. -2dBm
Compression point	Min. -6dBm

The Compression point result for the LNA is when 3.3V of DC power applied.

4. 2D Radiation Patterns

4.1 Test Setup – Free Space



4.2 LTE MIMO1

XY Plane

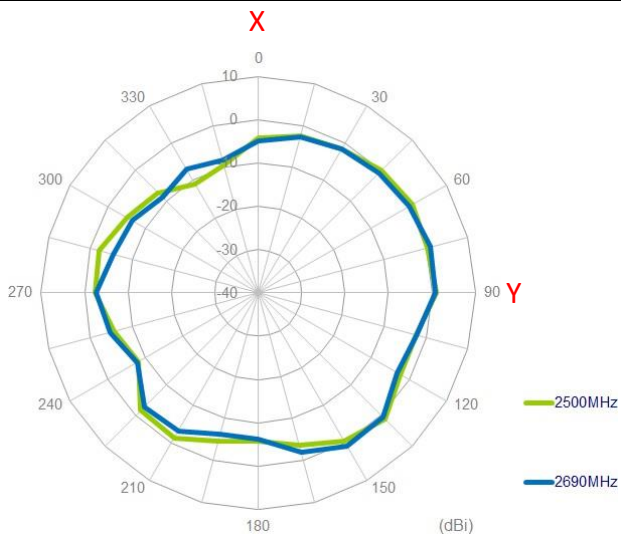
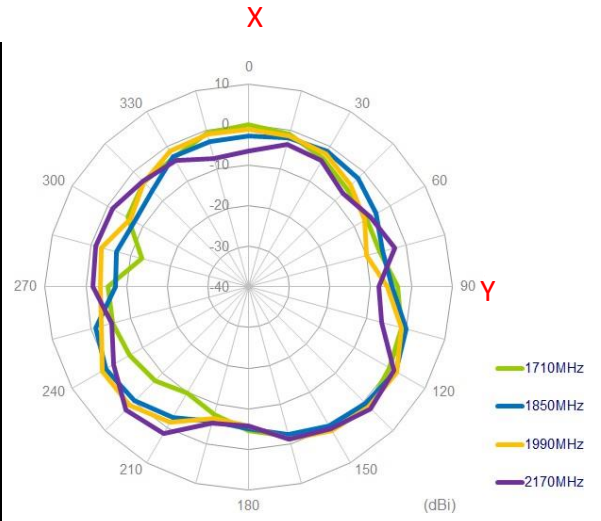
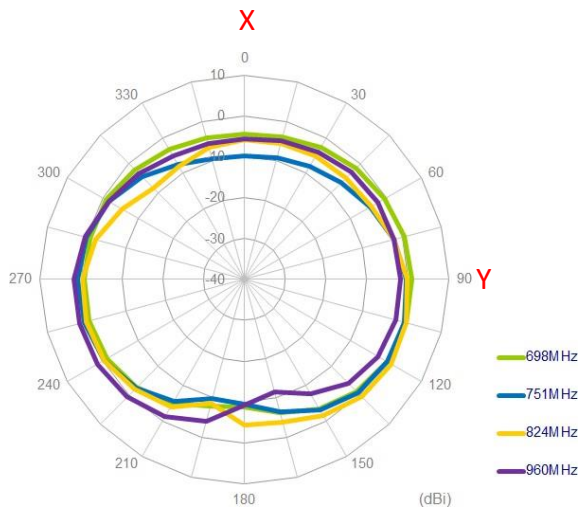

XZ Plane

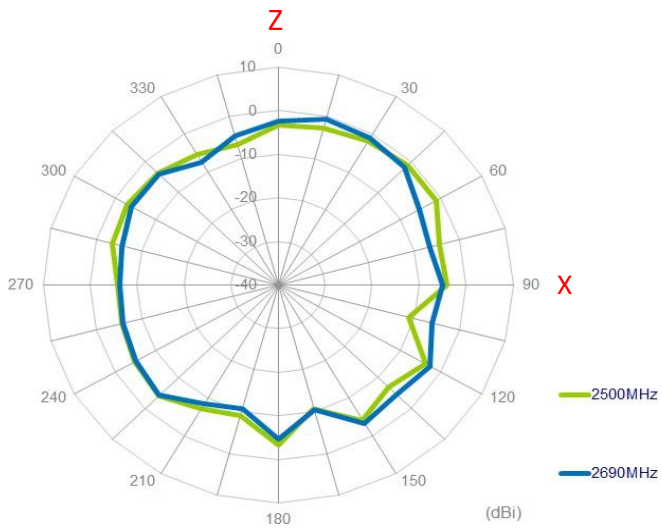
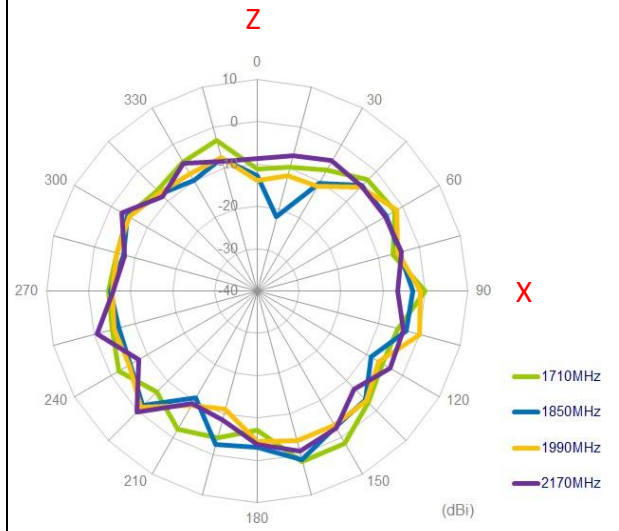
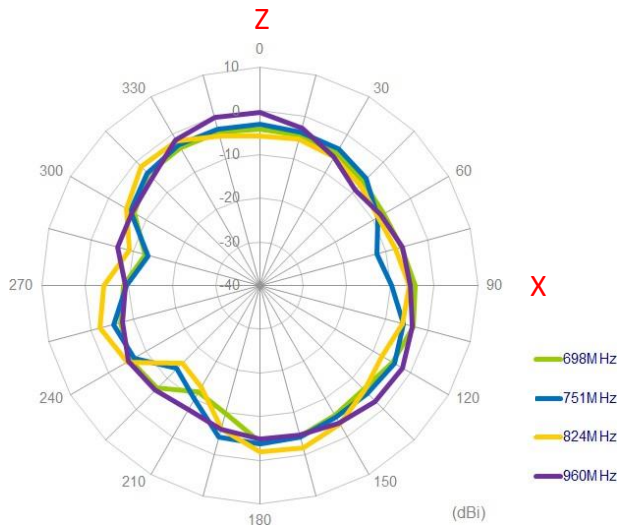

YZ Plane

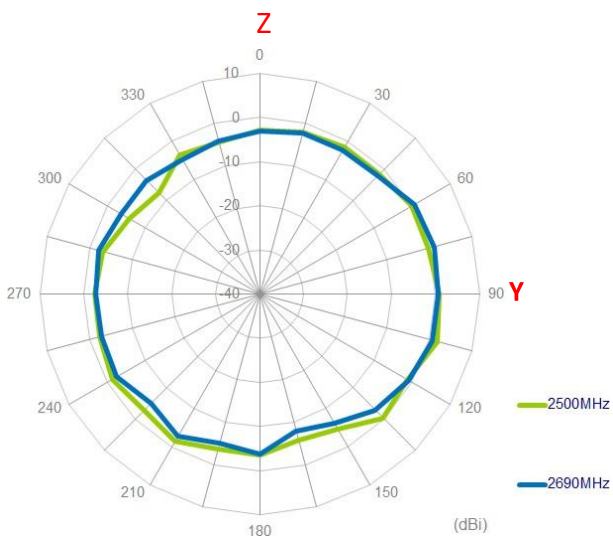
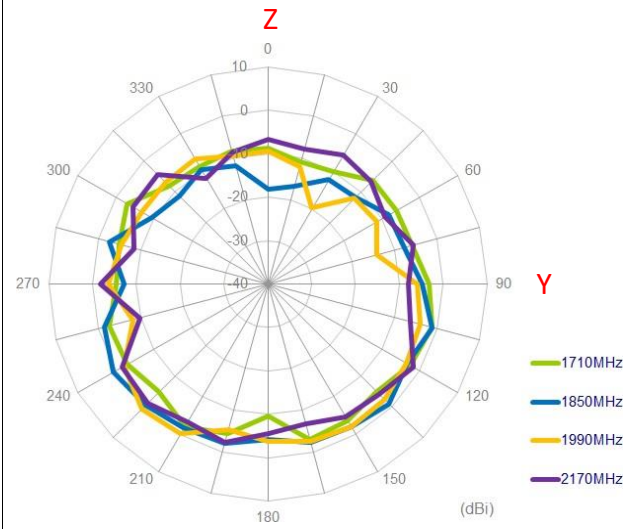
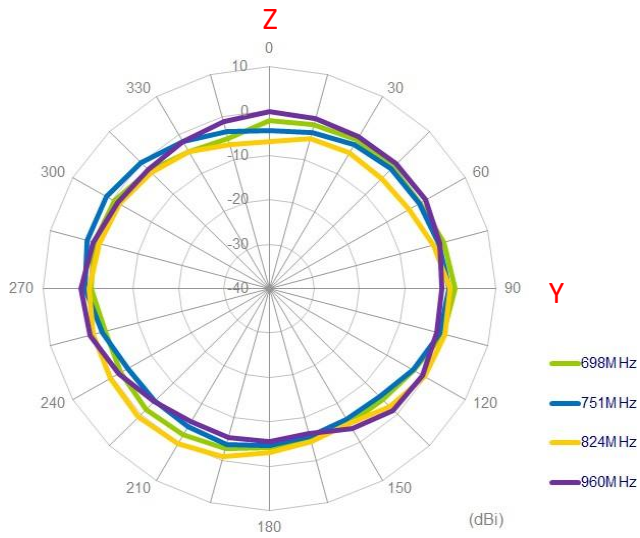

4.3 LTE MIMO2

XY Plane

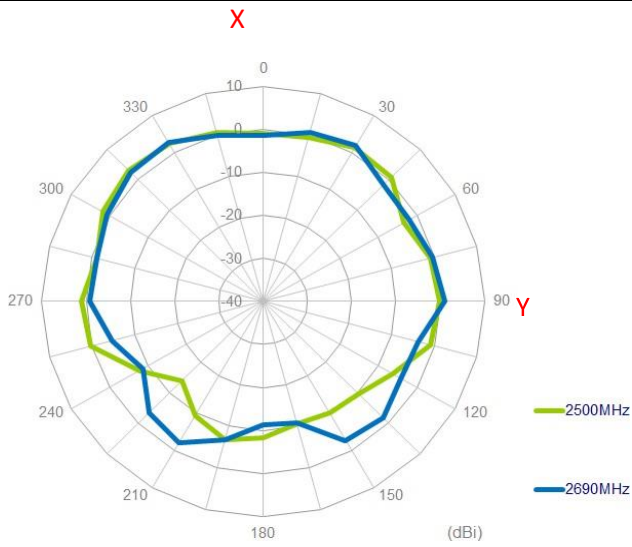
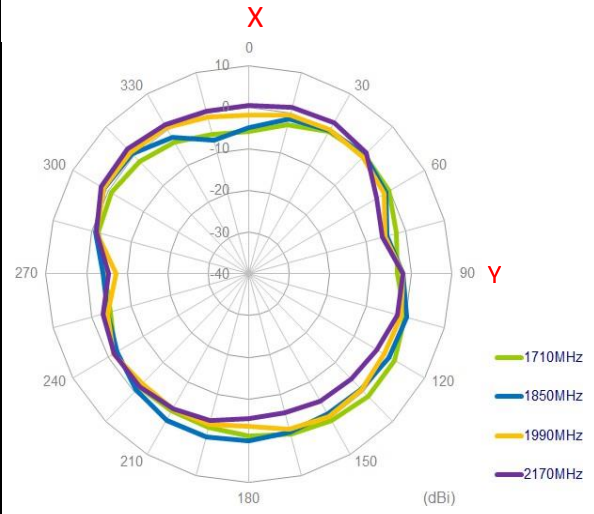
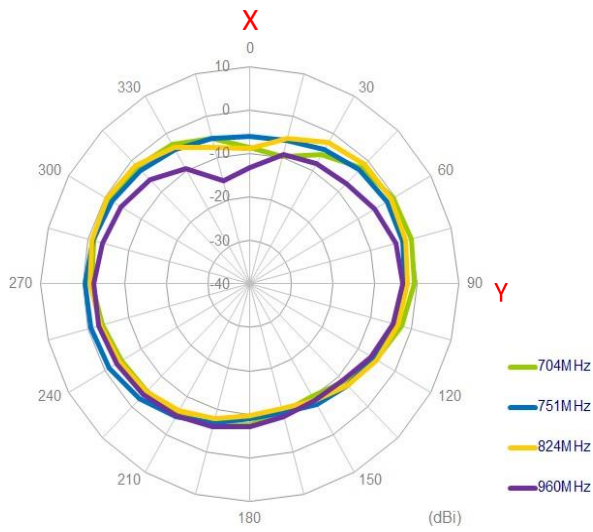

XZ Plane

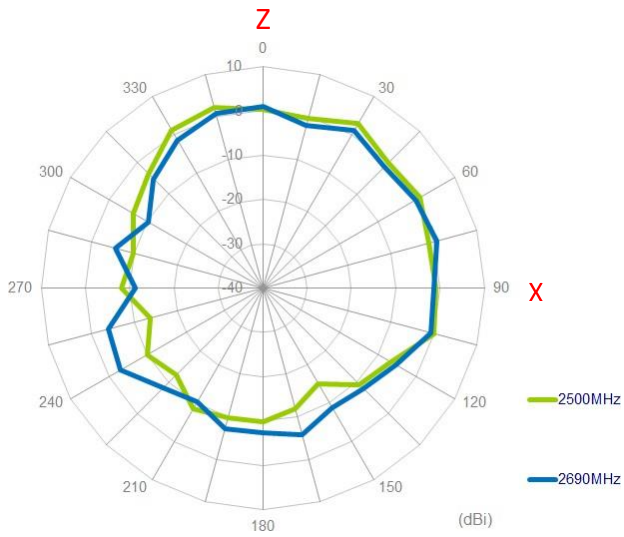
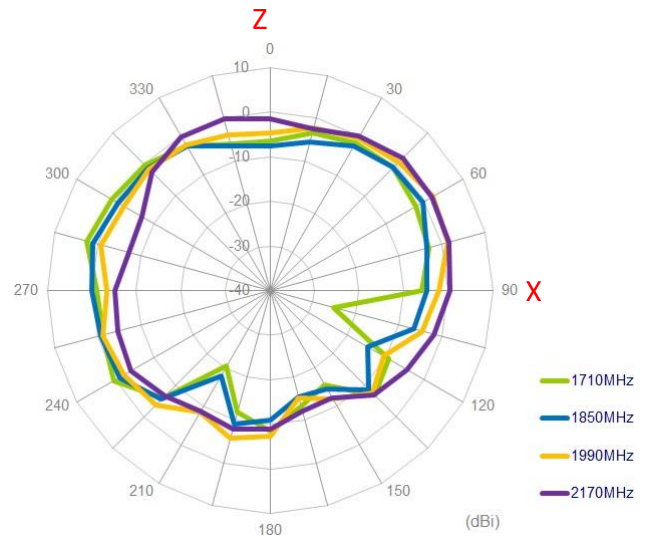
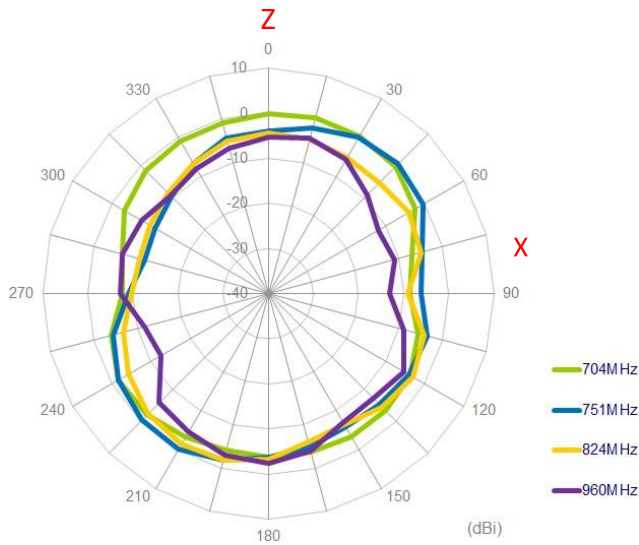

YZ Plane

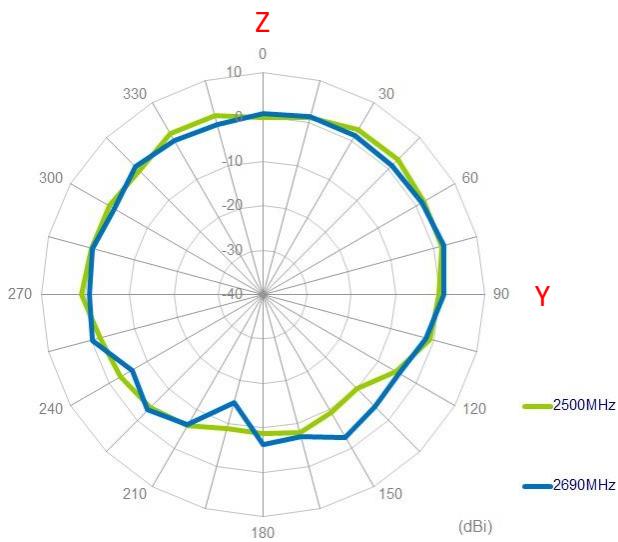
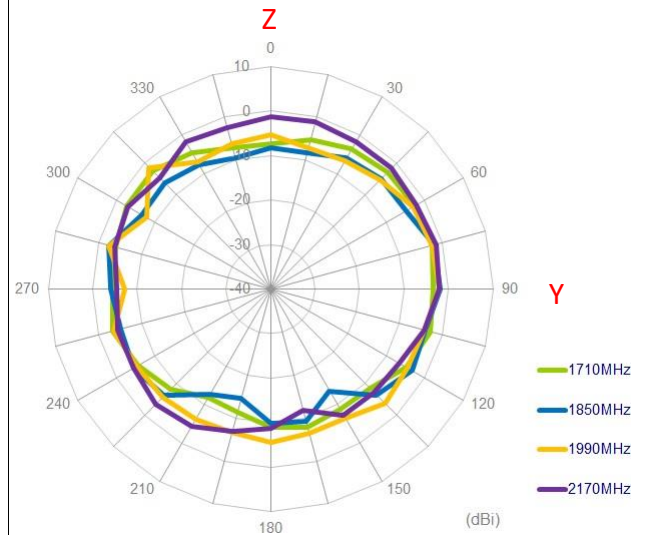
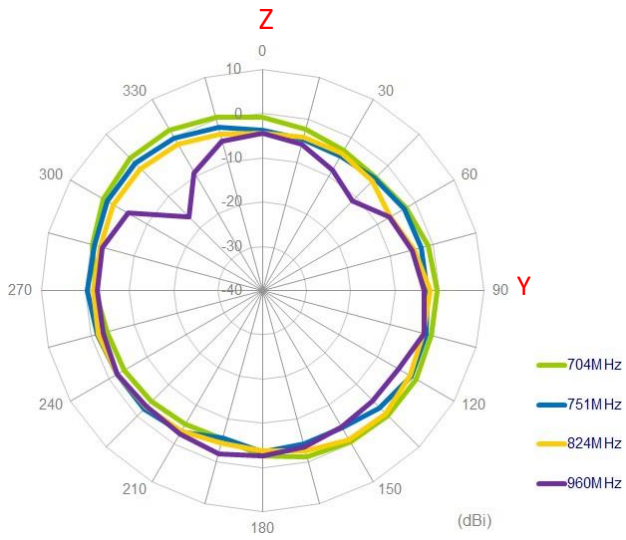

4.3 Wi-Fi

XY Plane

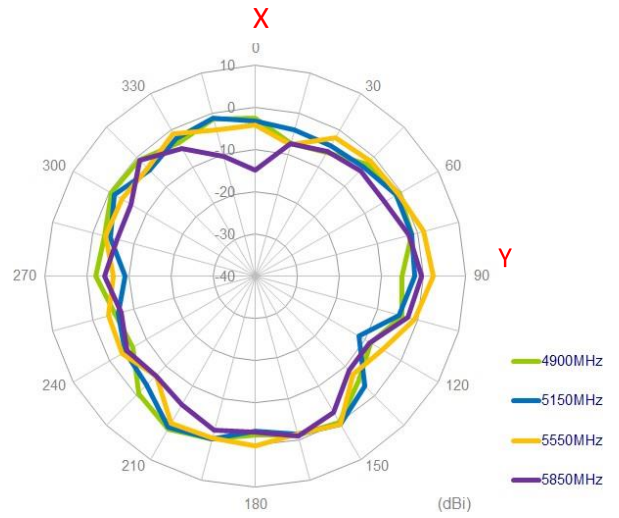
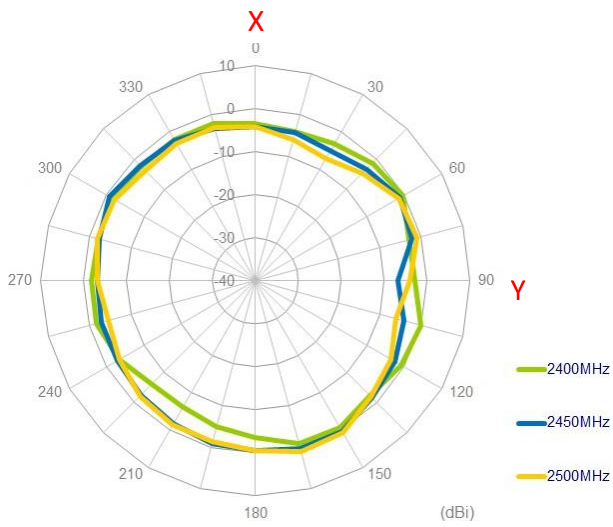

XZ Plane

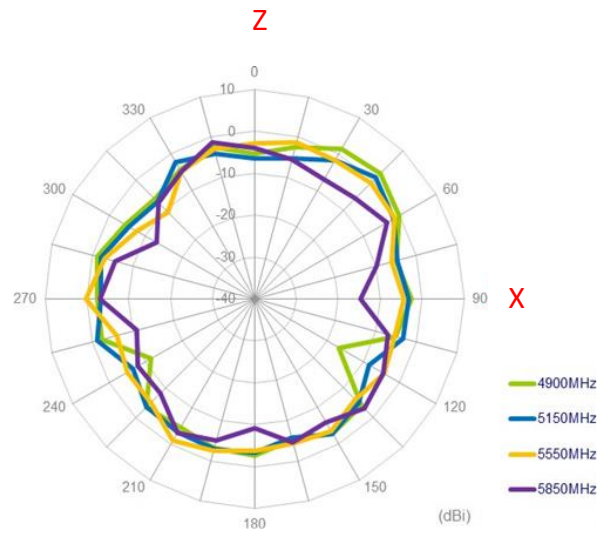
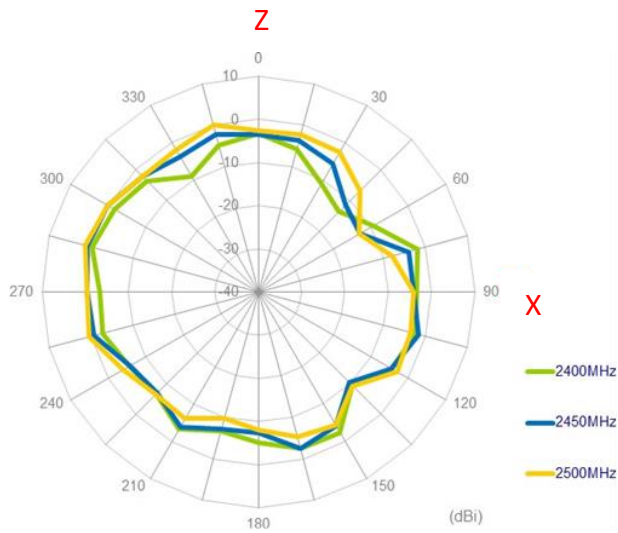

YZ Plane

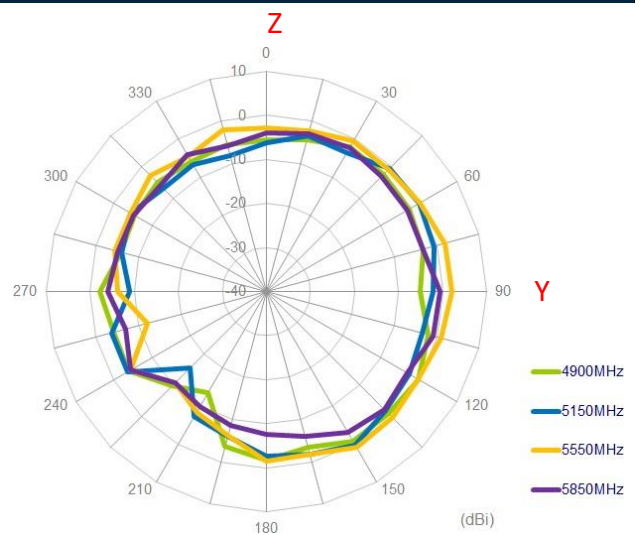
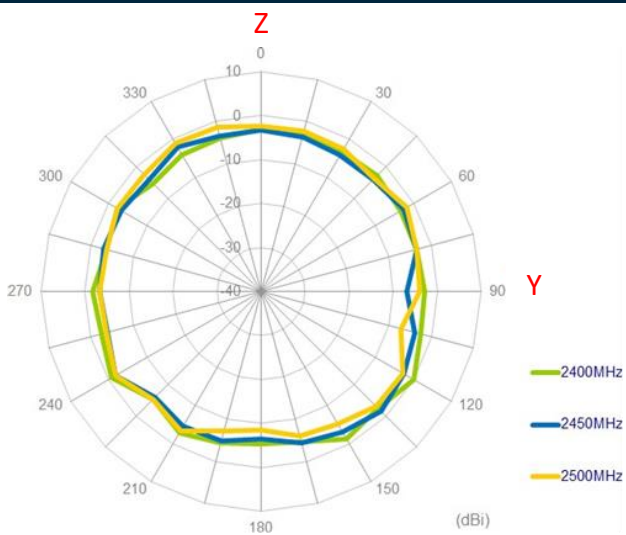

4.4 GNSS

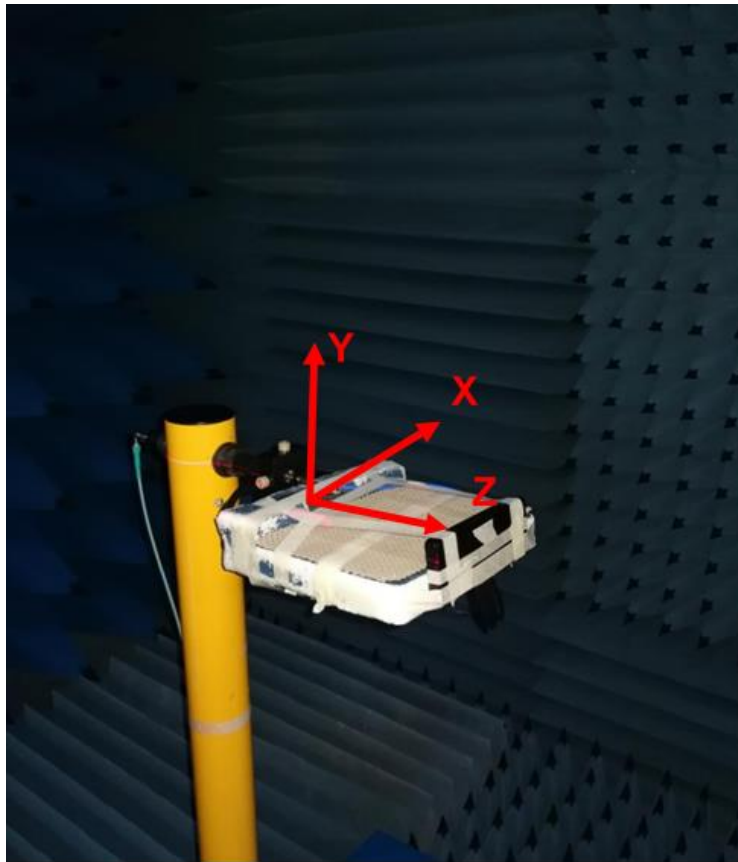

XY Plane

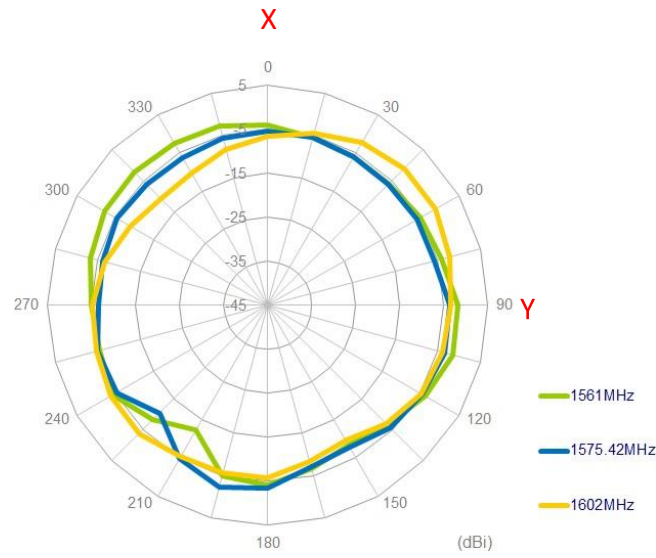

XZ Plane

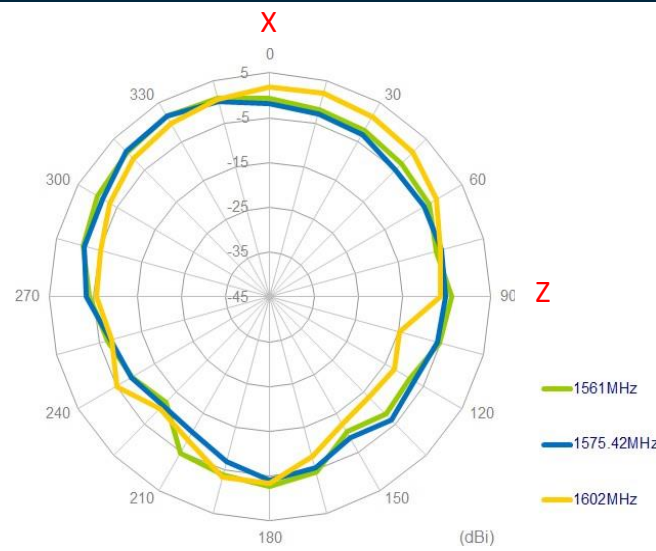

YZ Plane

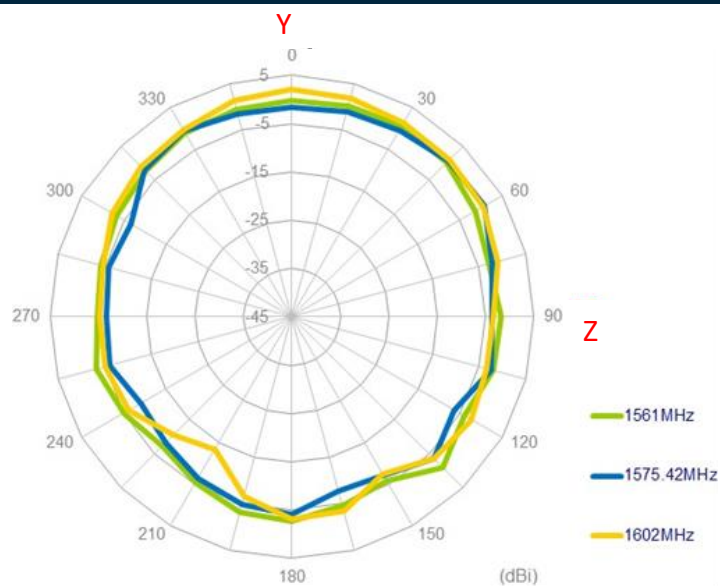

5. 3D Radiation Patterns

5.1 3D Radiation Patterns

LTE MIMO 1

698 MHz

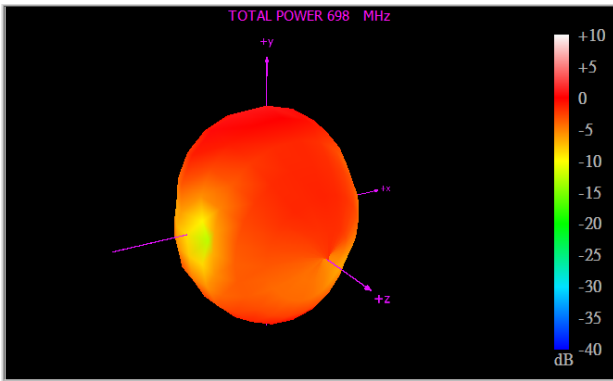

751 MHz

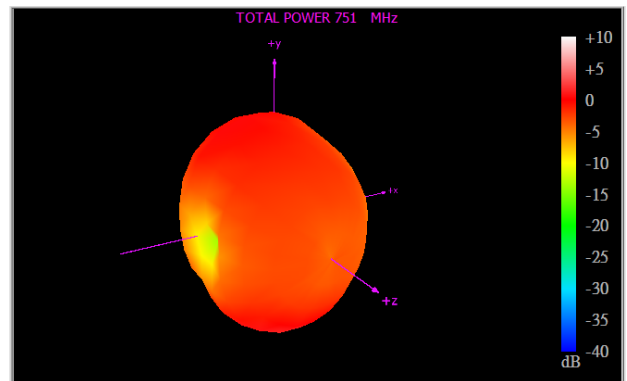

824 MHz

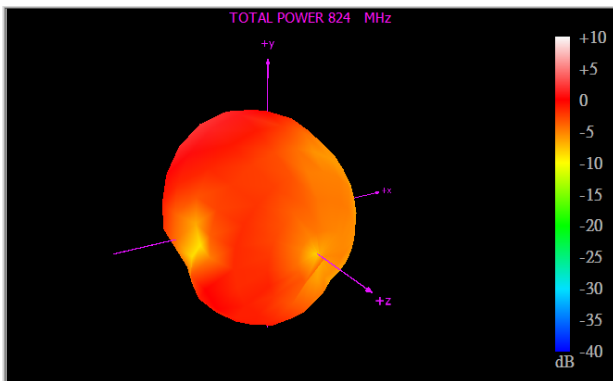

960 MHz

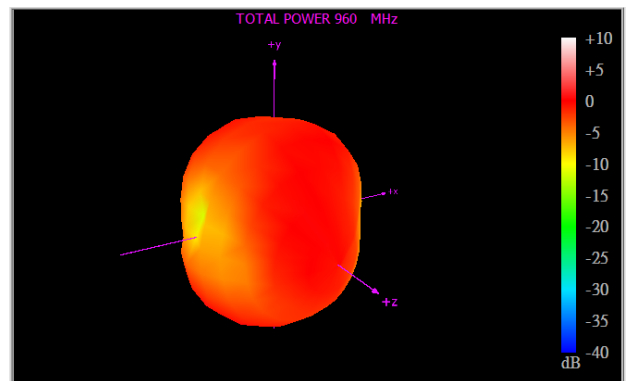

1710 MHz

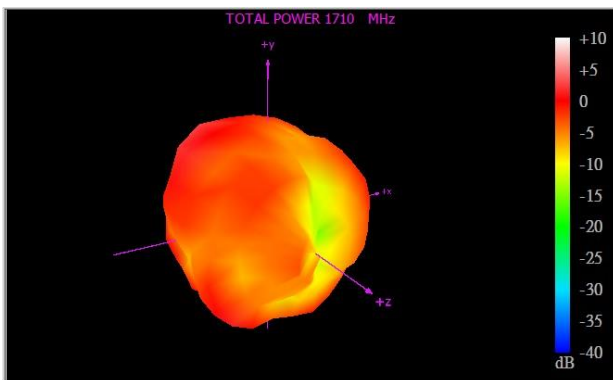

1850 MHz

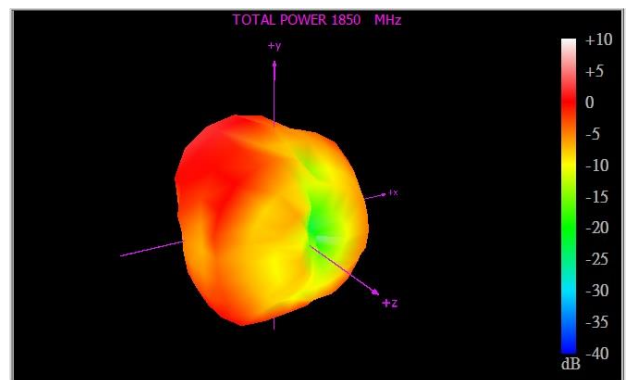

1990 MHz

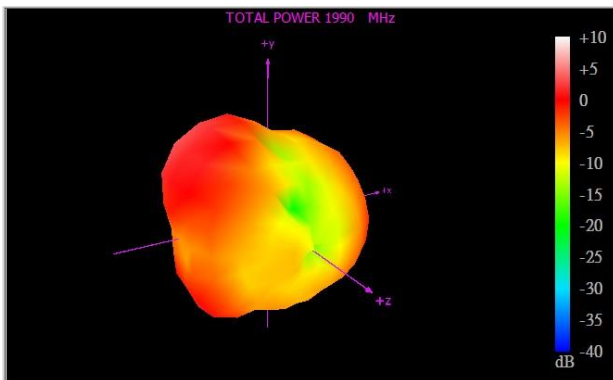

2170 MHz

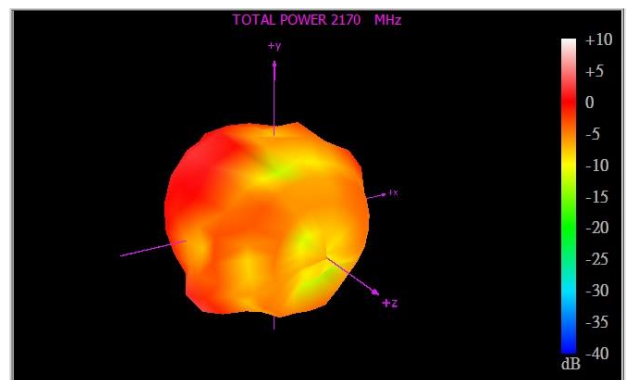

2500 MHz

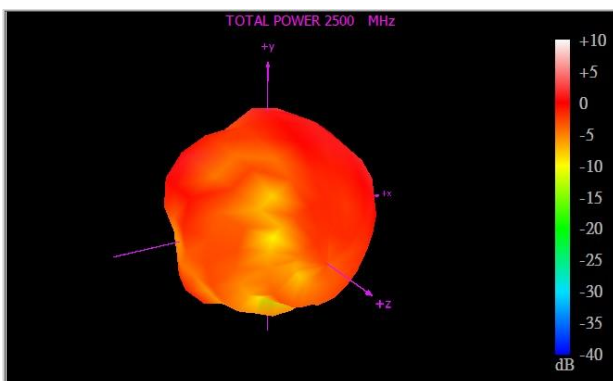

2690 MHz

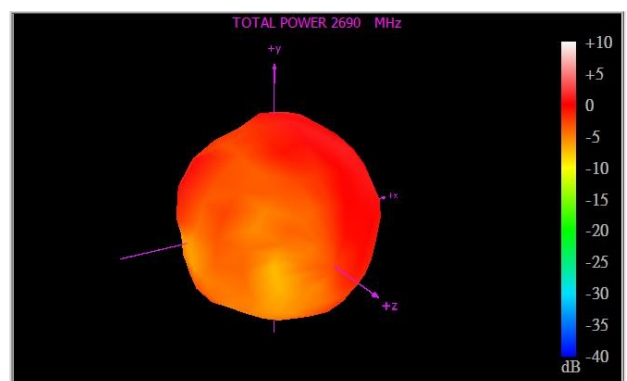

LTE MIMO 2

698 MHz

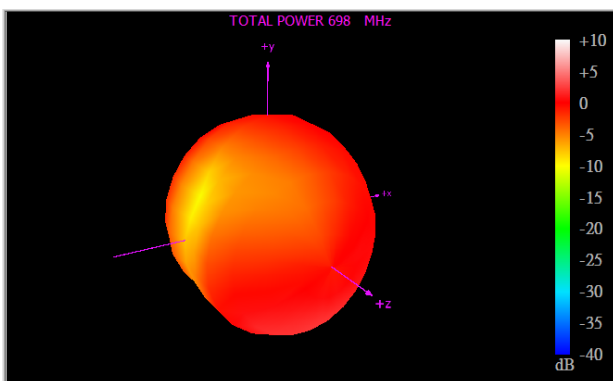

751 MHz

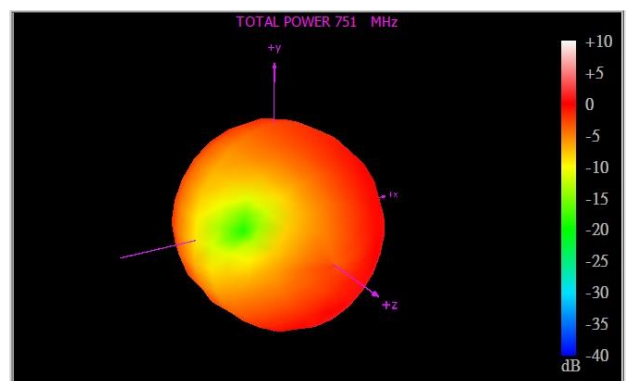

824 MHz

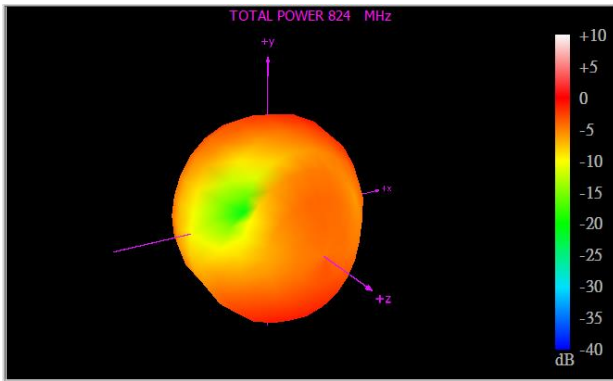

960 MHz

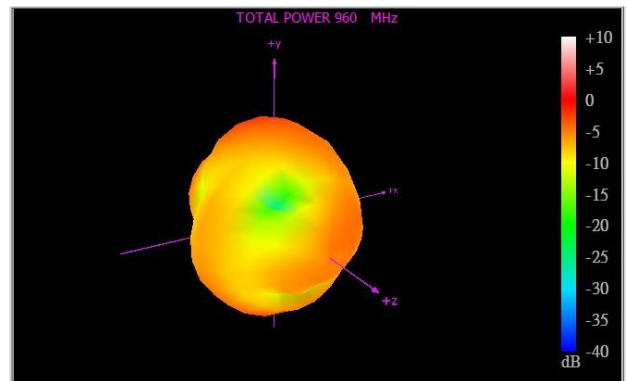

1710 MHz

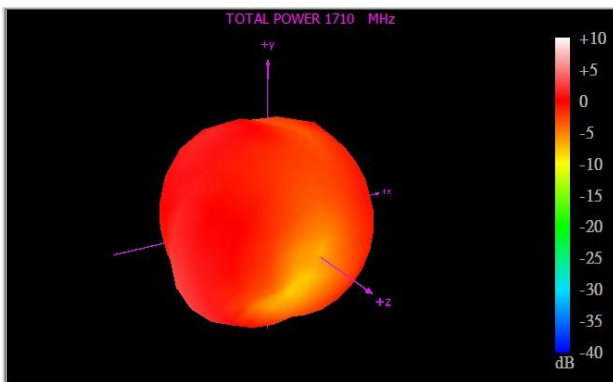

1850 MHz

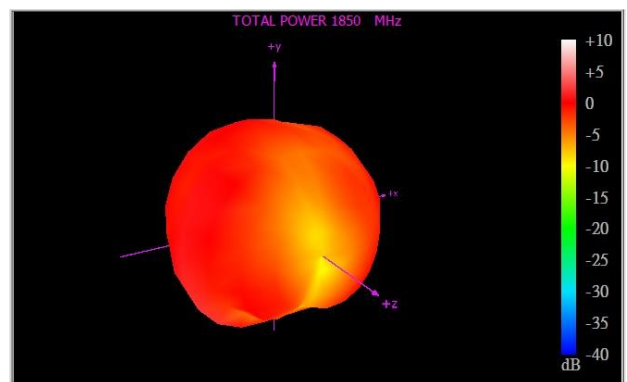

1990 MHz

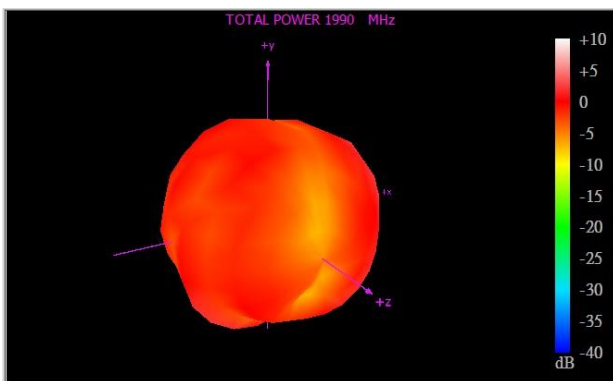

2170 MHz

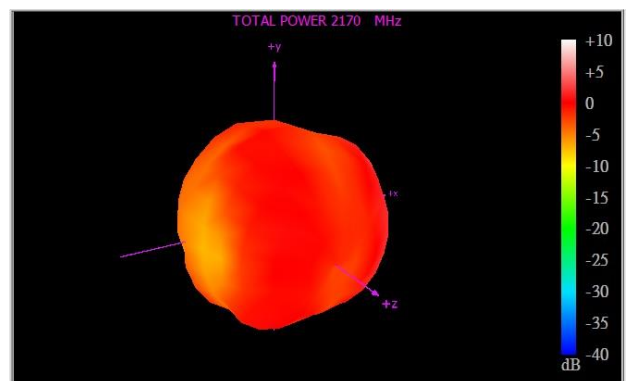

2500 MHz

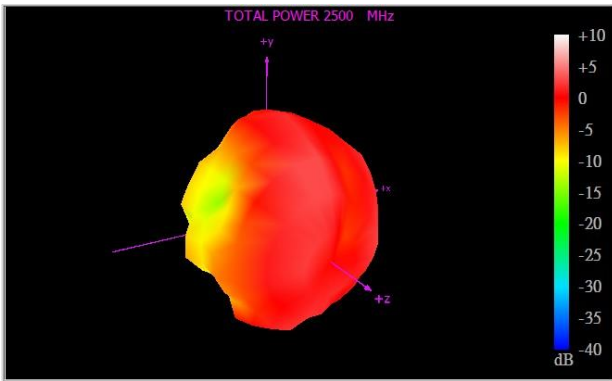

2690 MHz

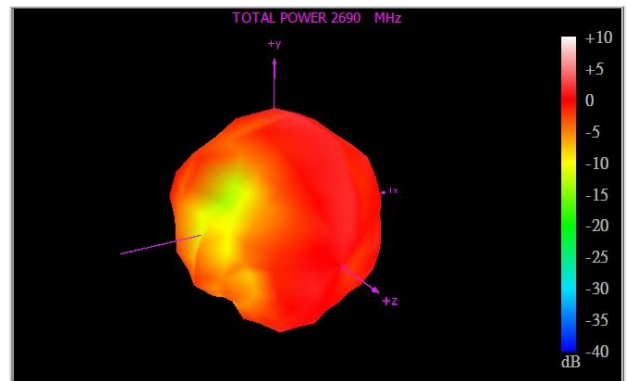

Wi-Fi

2400 MHz

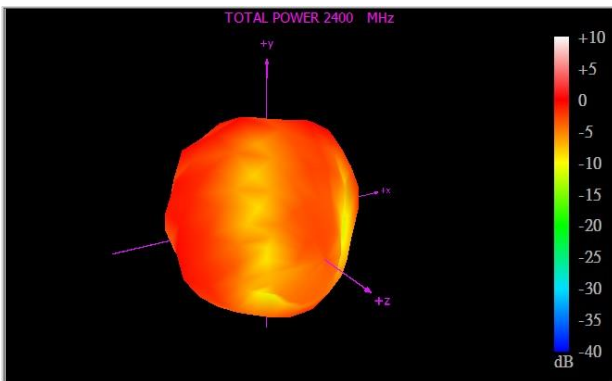

2450 MHz

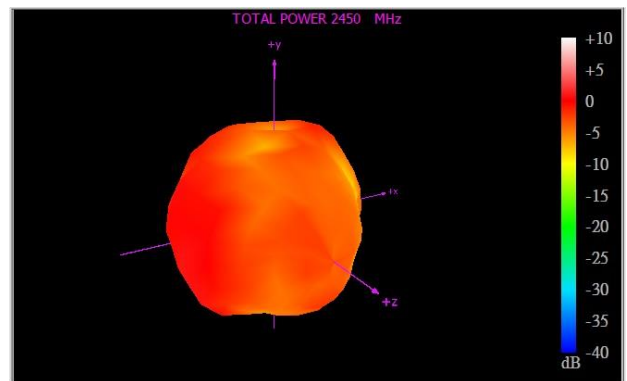

2500 MHz

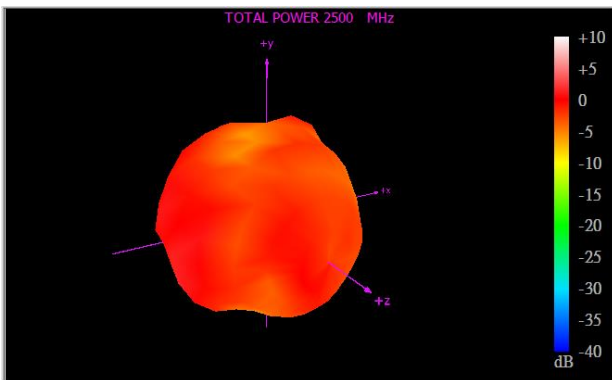

4900 MHz

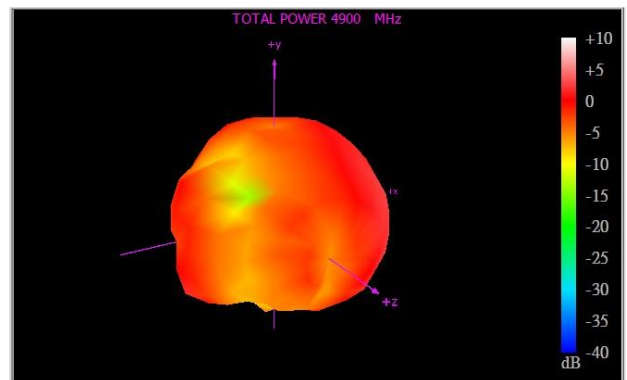

5150 MHz

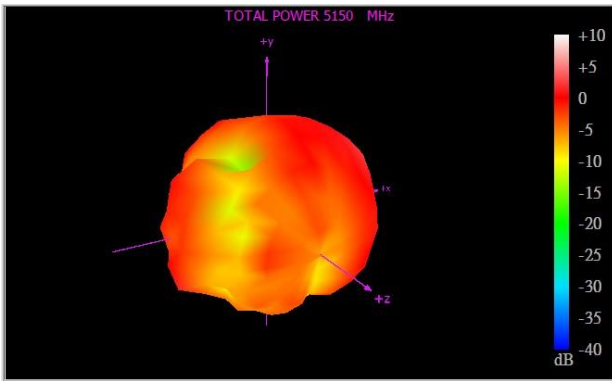

5550 MHz

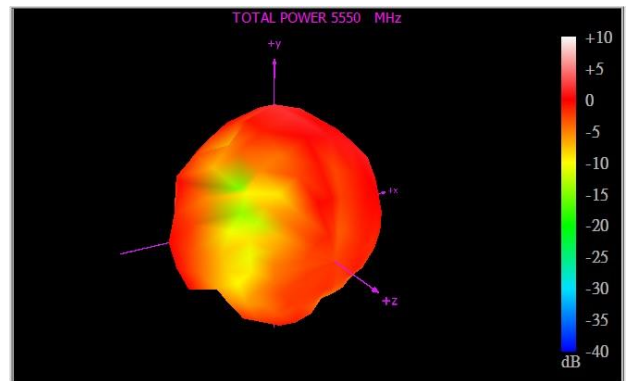

5850 MHz

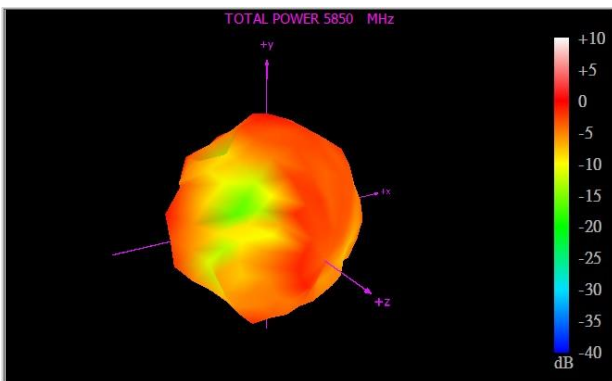

GNSS

1561 MHz

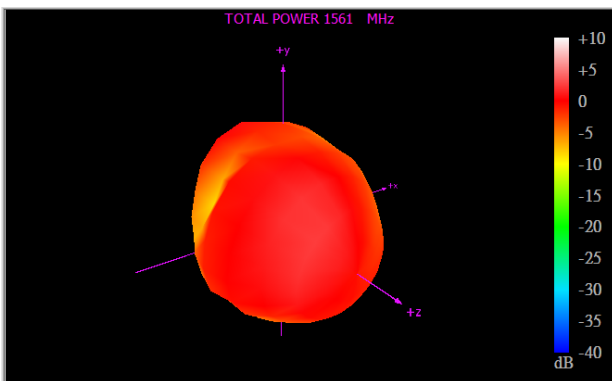

1575.42 MHz

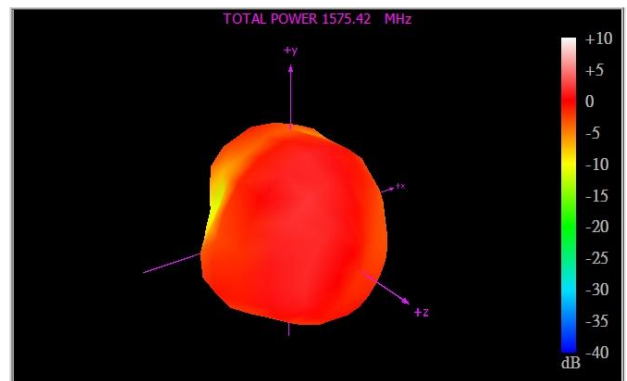

1602 MHz

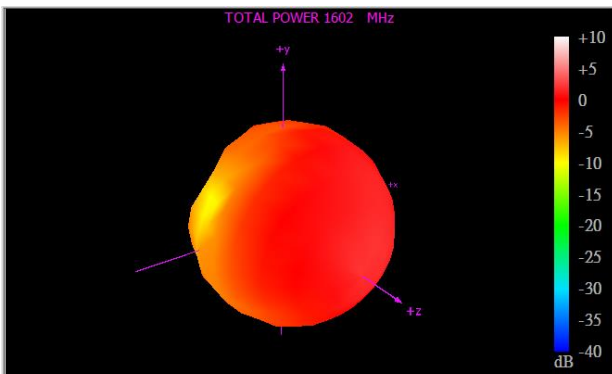

6. Mechanical Drawing (Units: mm)

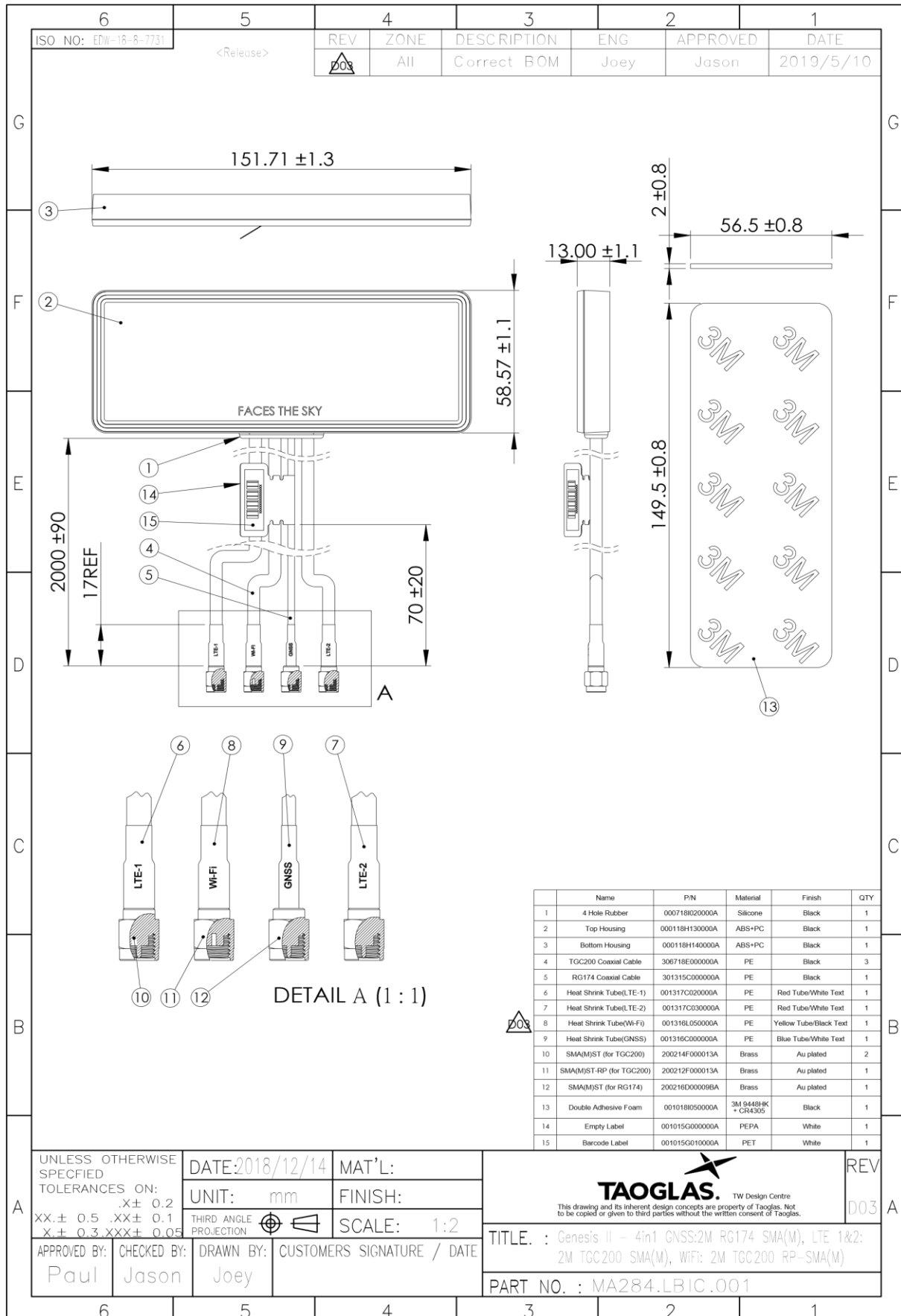

7. Packaging

1 pc MA284.LBIC.001 per PE Bag
 Dimensions - 280*450mm
 Weight - 352g

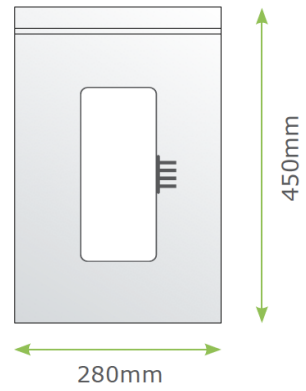

10 PE Bags per Small Carton
 Carton Dimensions - 390*260*330mm
 Weight - 3.5Kg

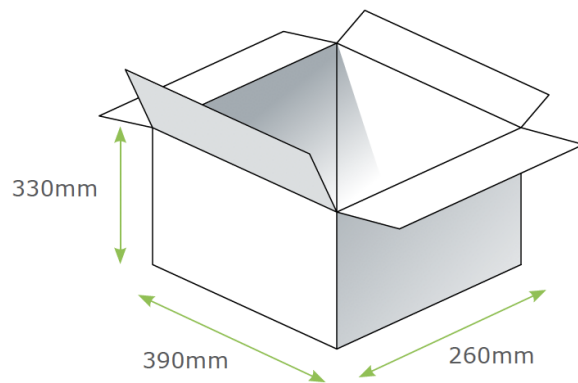

8. Application Notes

The MA284 antenna Performance with different cable lengths is shown below.

8.1 Return Loss

LTE MIMO 1

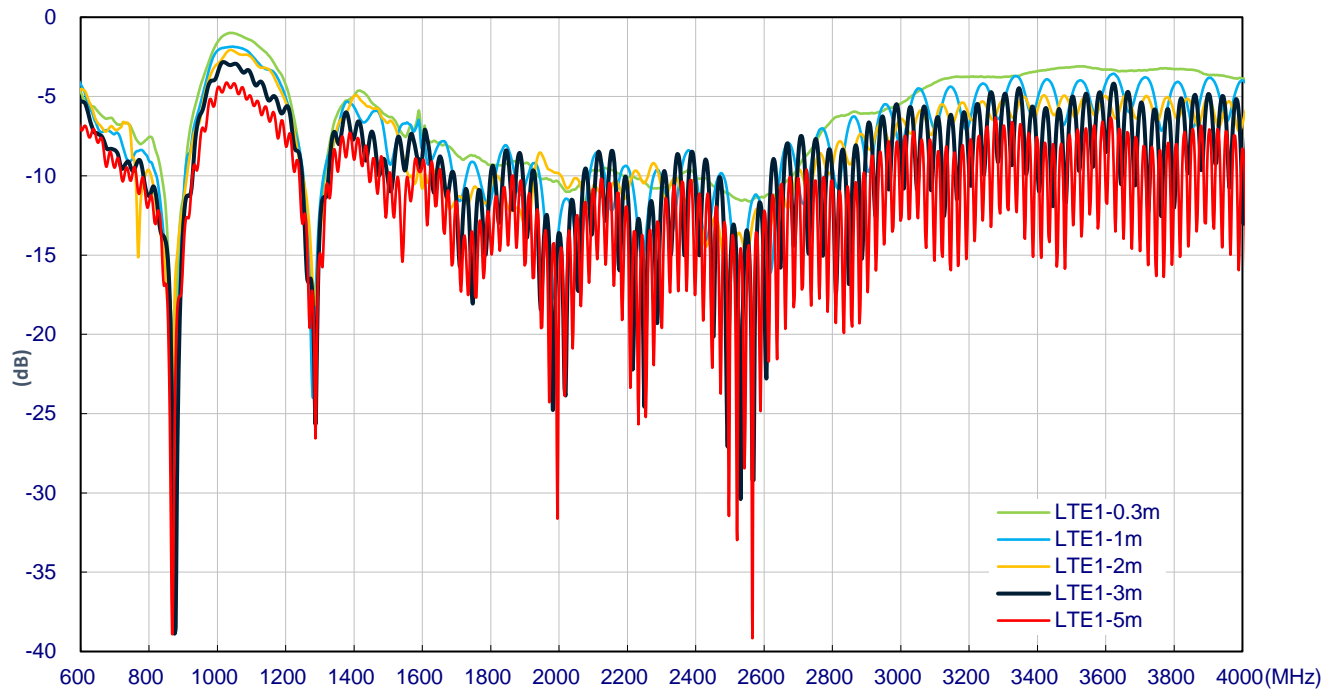

LTE MIMO 2

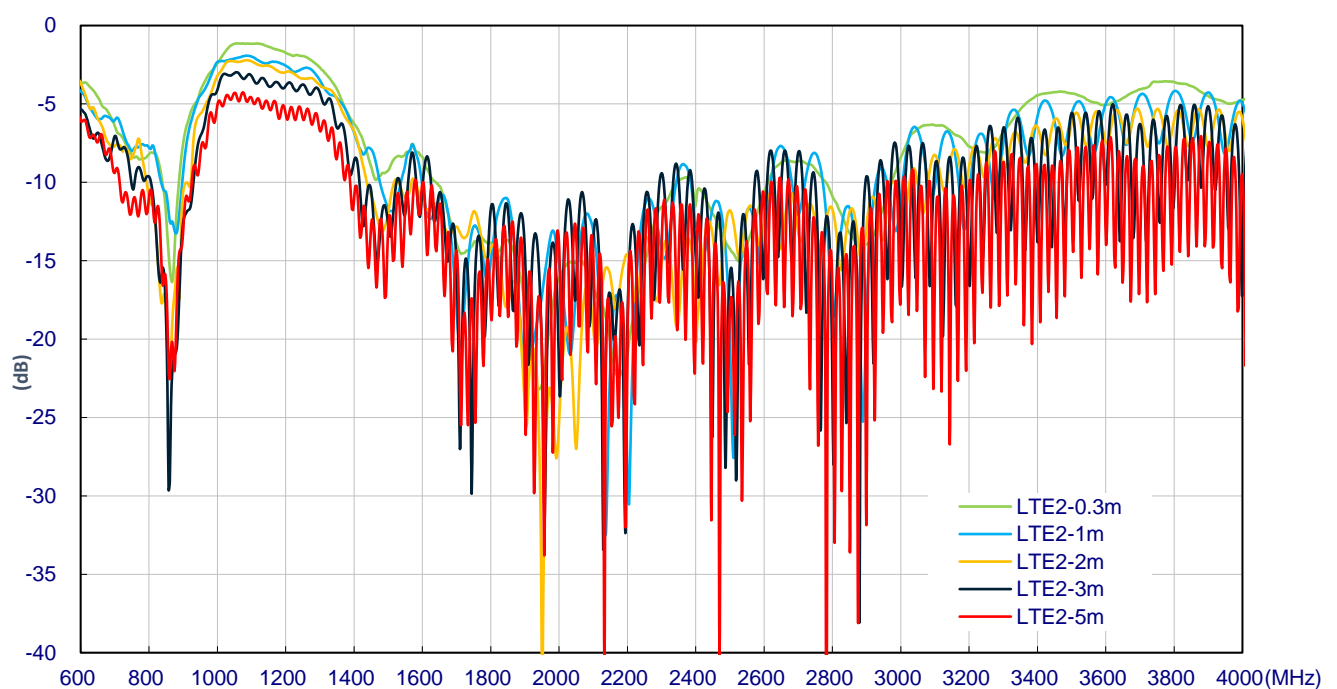

Wi-Fi

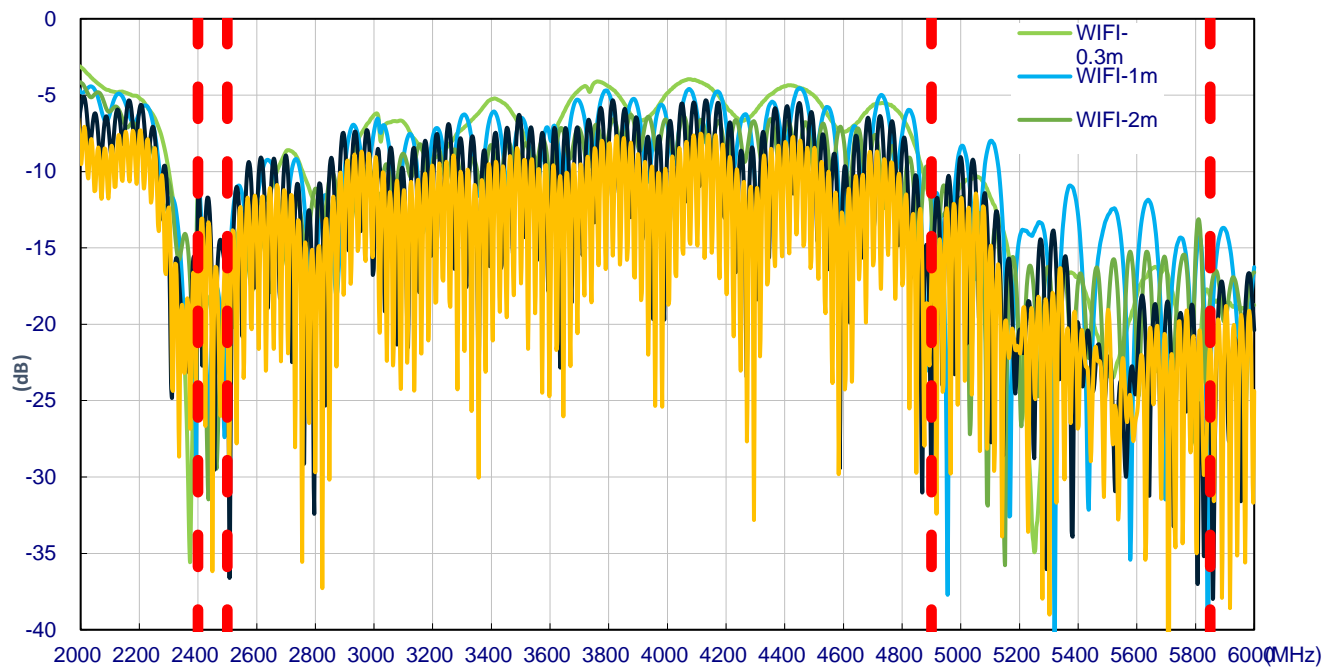

8.2 Efficiency

LTE MIMO 1

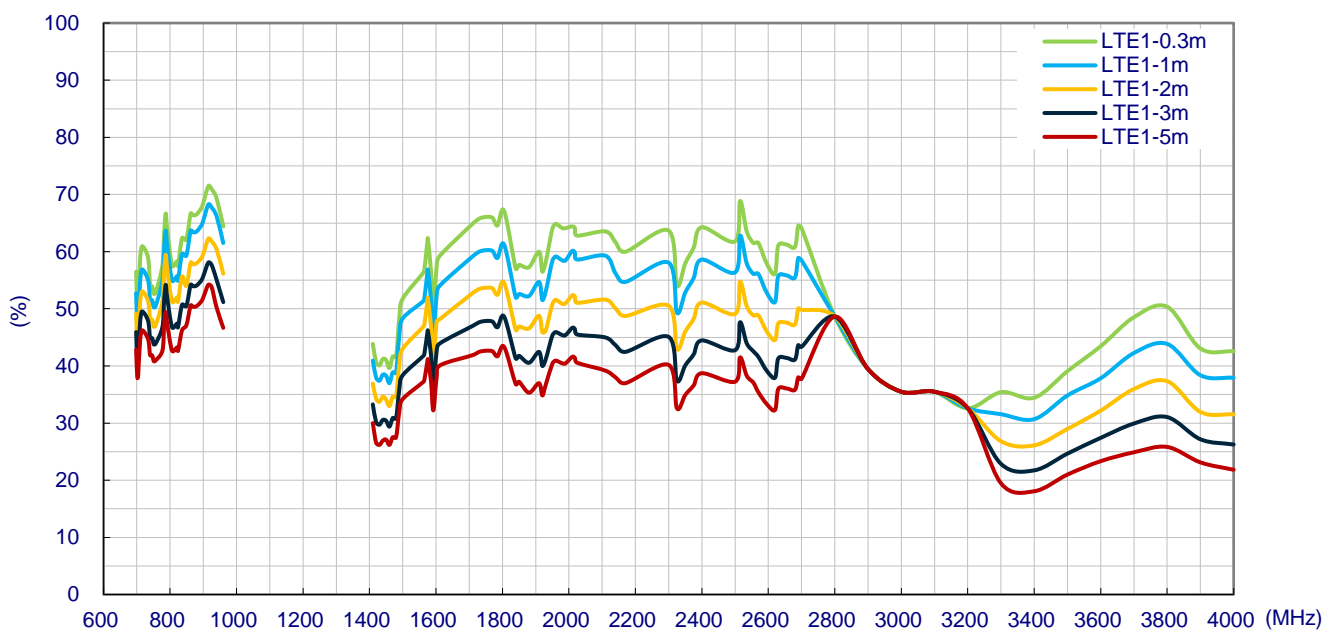

LTE MIMO 2

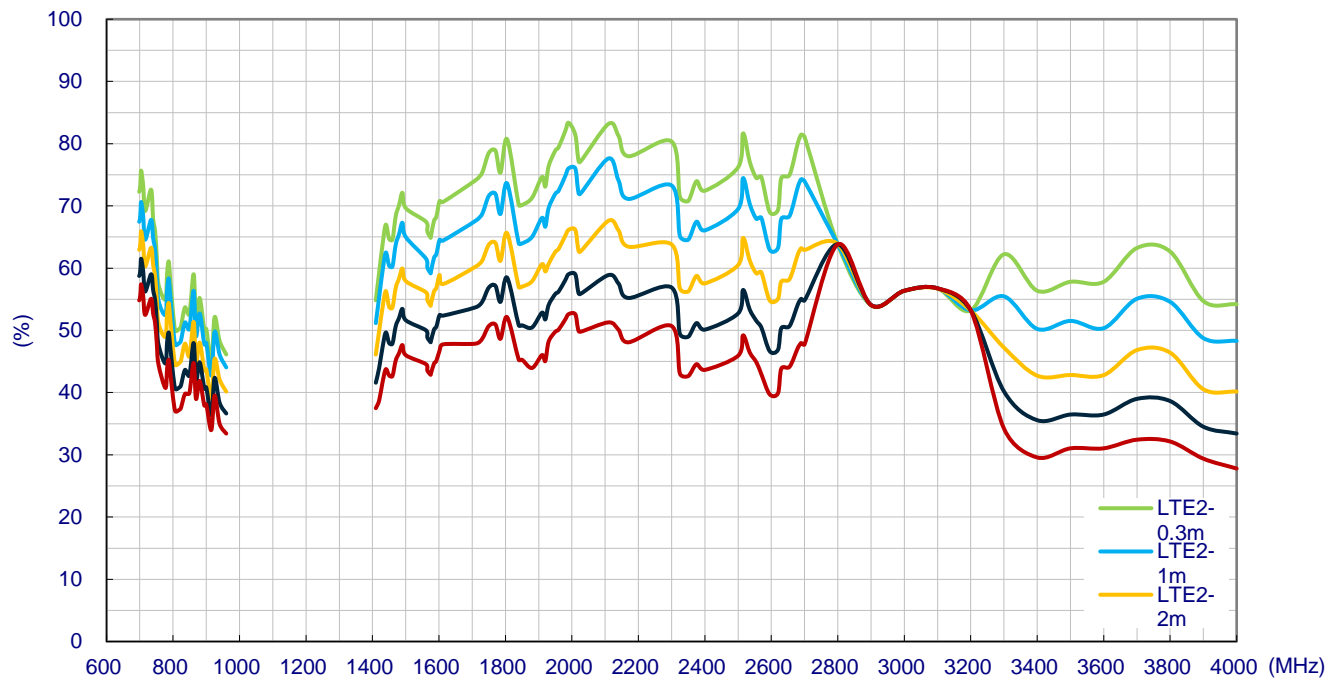

Wi-Fi

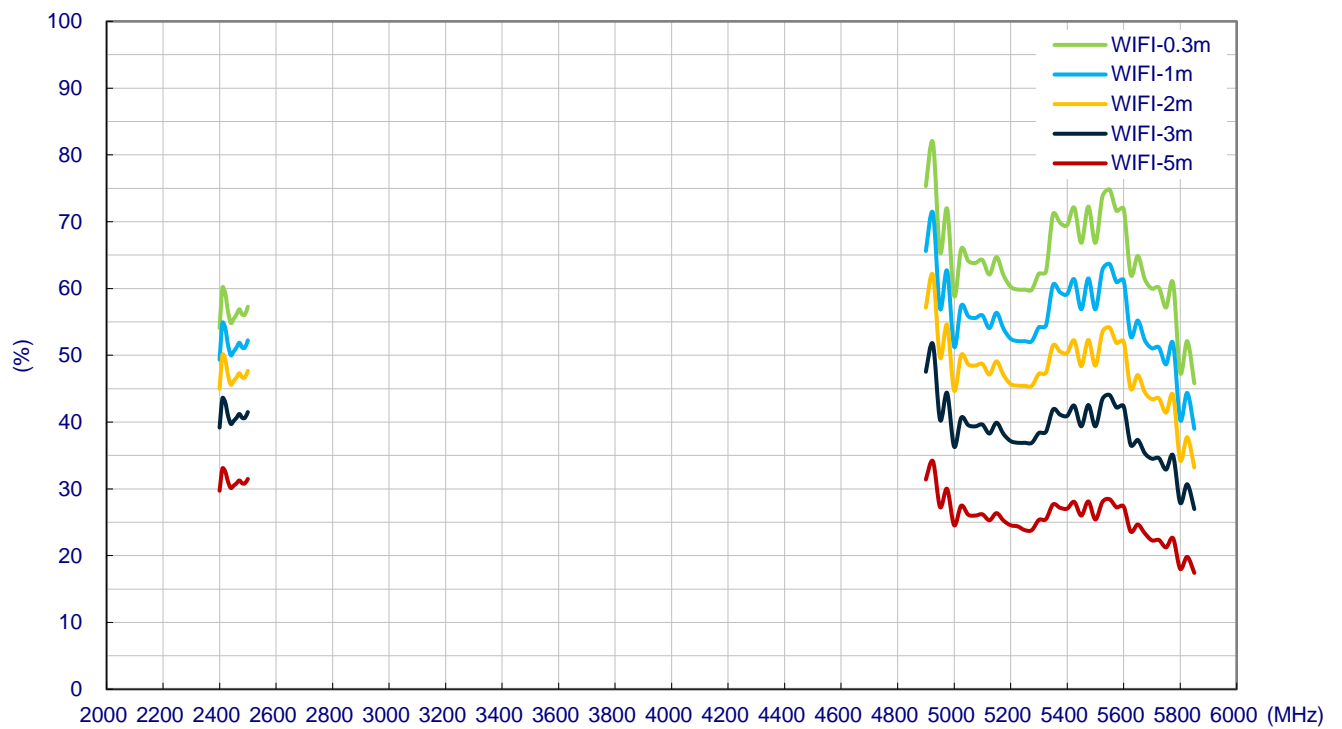

8.2 Average Gain

LTE MIMO 1

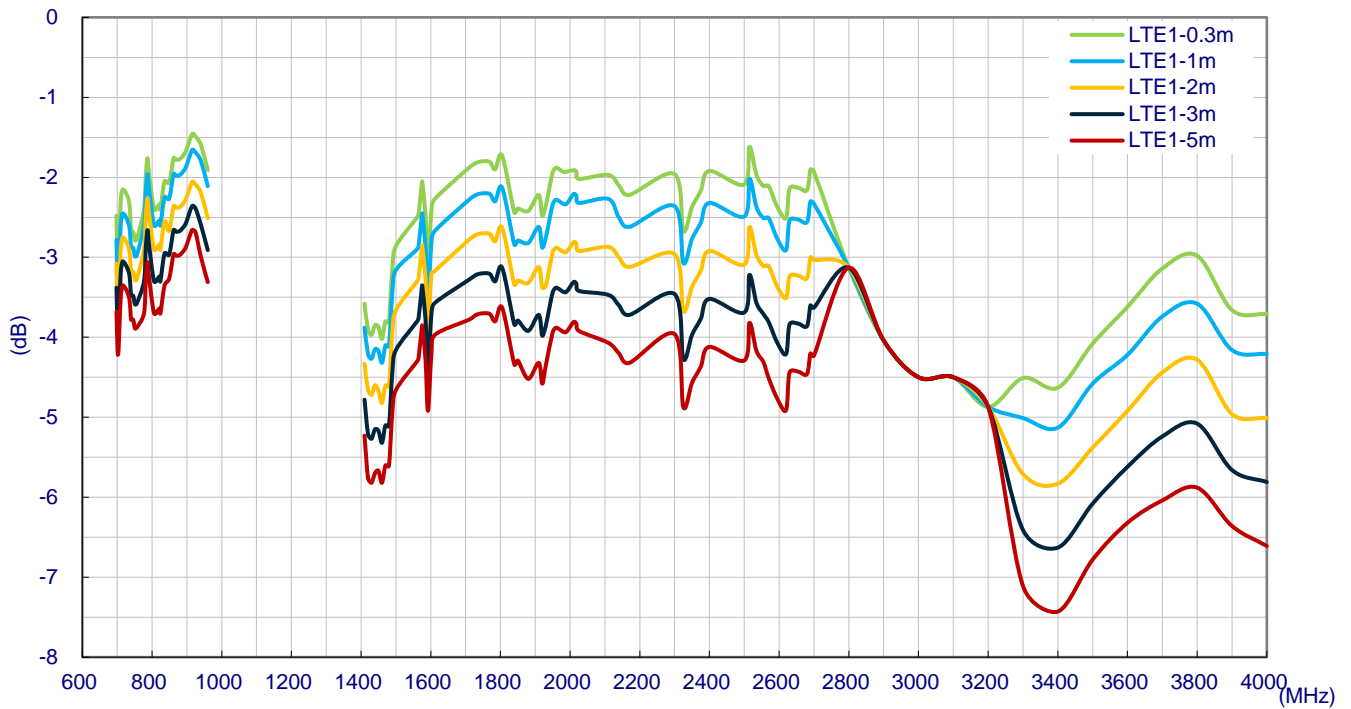

LTE MIMO 2

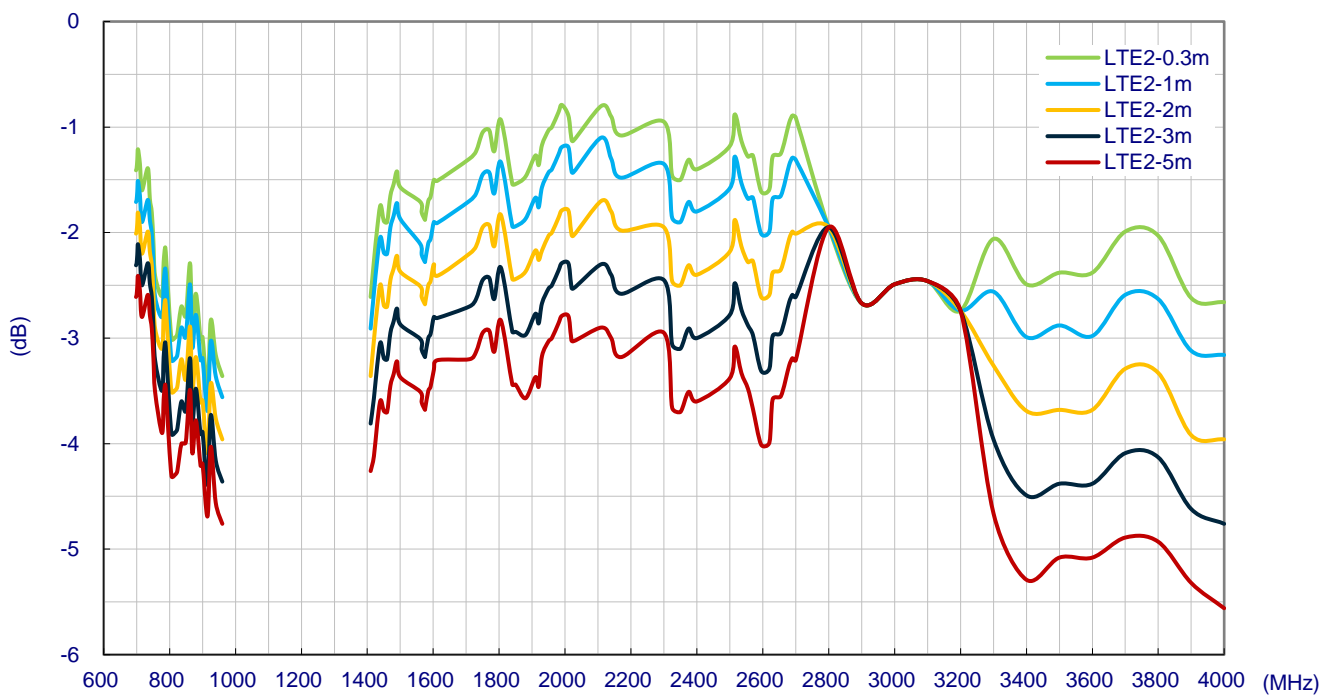

Wi-Fi

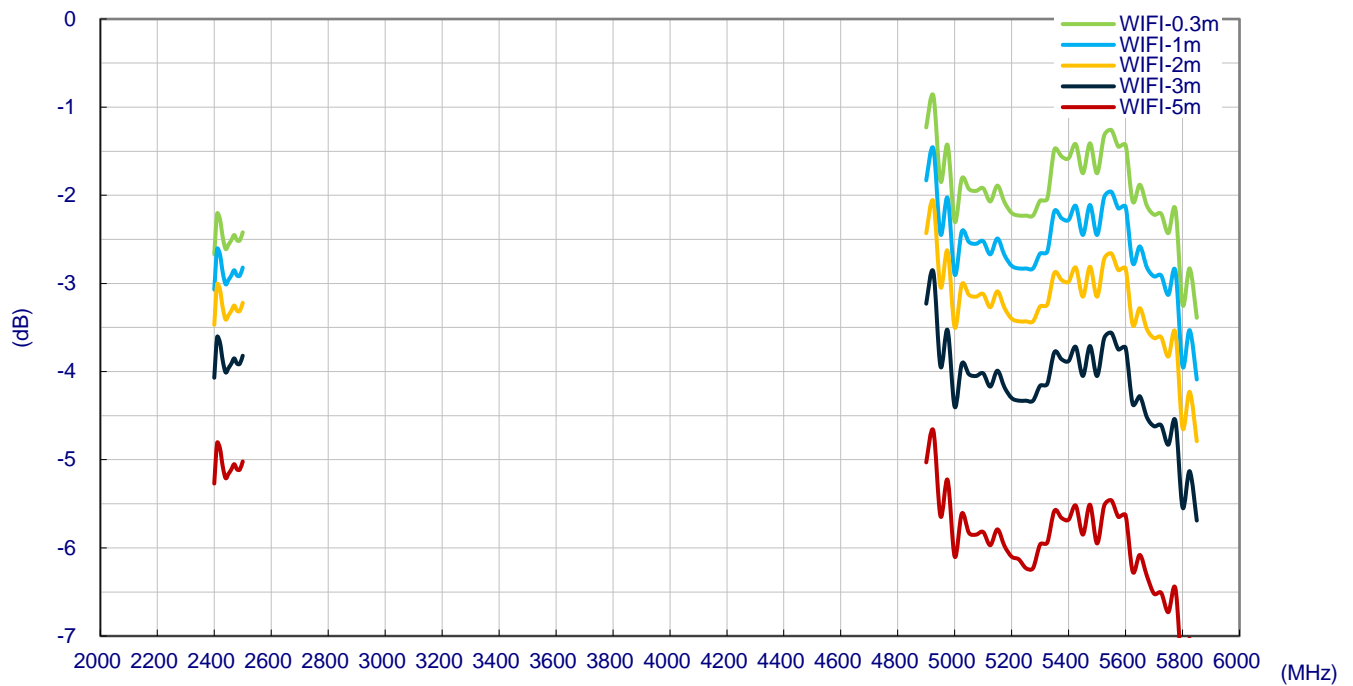

8.2 Peak Gain

LTE MIMO 1

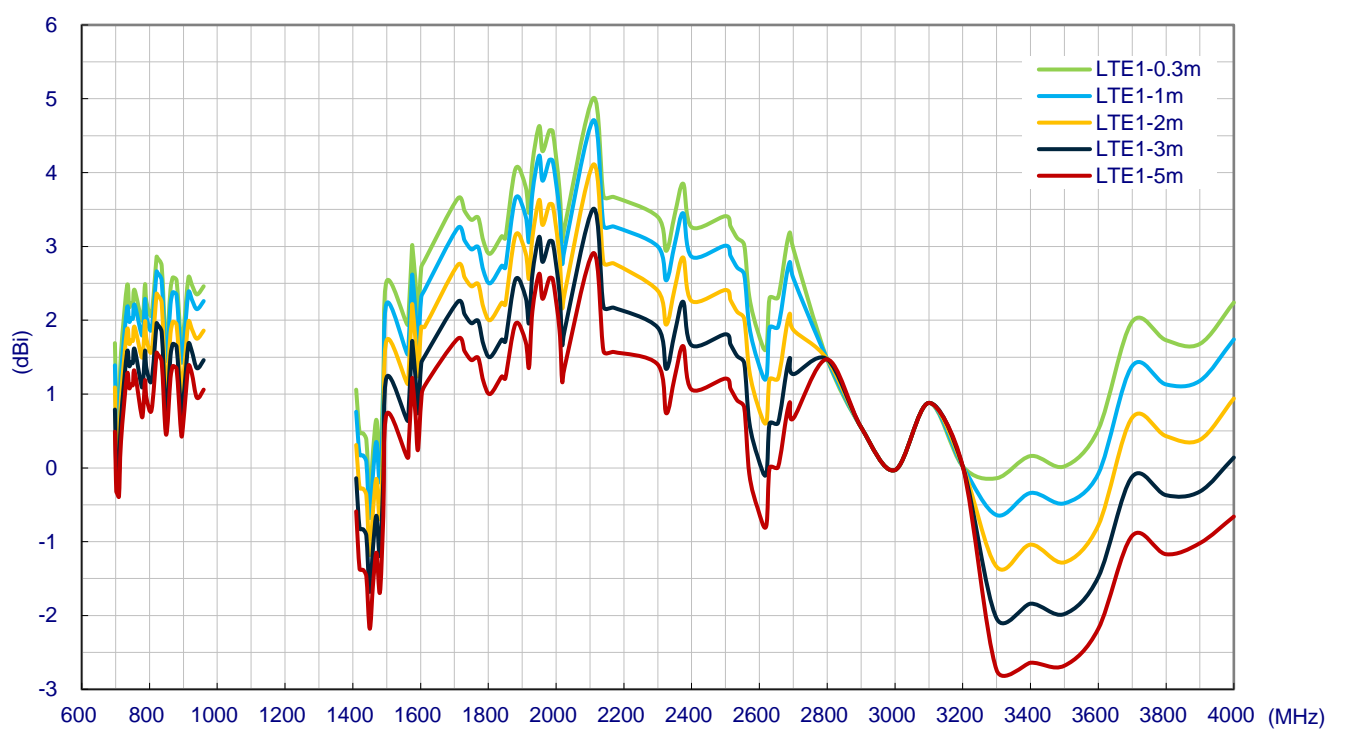

LTE MIMO 2

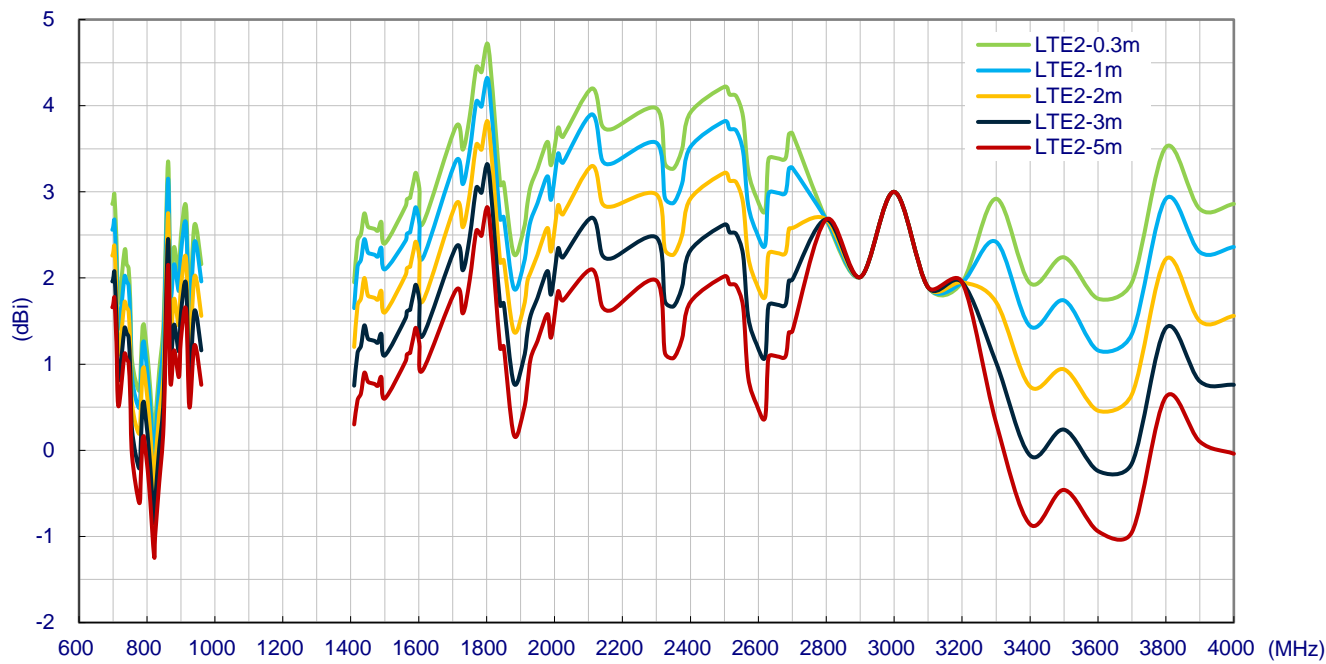

Wi-Fi

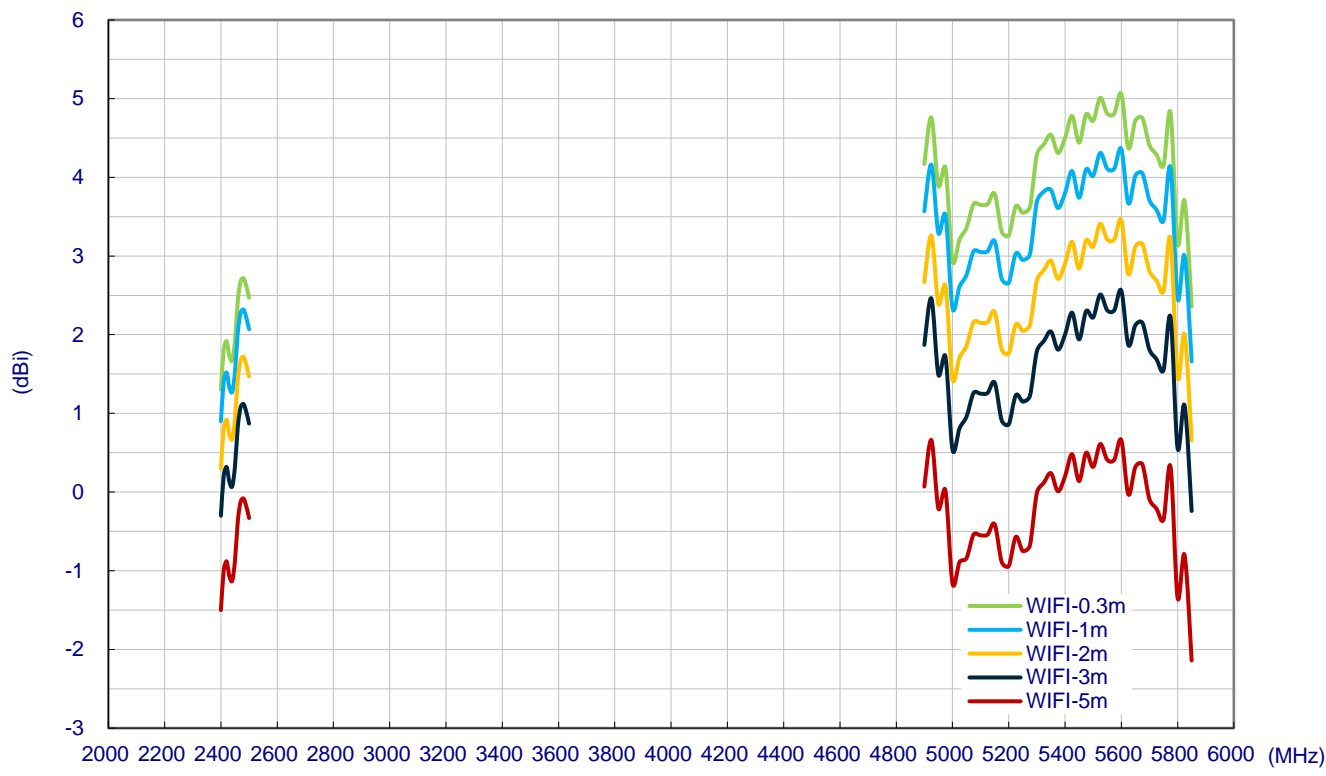

9. Vibration Test

Product Category:	Antenna
Product Series Name:	Genesis II
Product Model Part No.:	MA284.LBIC.001
Quantity Tested:	2 pcs
Date of Testing:	03/13-14 , 2019
Test Required:	Vibration Test
Batch No:	(SWEI001)

9.1 Test Equipment

<i>Name</i>	<i>Brand</i>	<i>Model</i>	<i>Serial No.</i>	<i>Calibration Date</i>
Vibration test system	Vibration-Source	VS-300V	E00404	2018/08/07
Controller	V5.0	Super-2	243552379	2018/08/07
Network Analyzer	KEYSIGHT	E5071C	MY46526857	2018/12/23

9.2 Lab Environmental Conditions

Ambient Temperature	25±3°C
Relative Humidity	65±20%RH

9.3 Test Method/Specification

Sample condition:	Unpacked														
Wave form:	Random														
Frequency:	10~1000Hz														
	<table border="1"> <thead> <tr> <th>Frequency (Hz)</th> <th>PSD (m/s²)²/Hz</th> </tr> </thead> <tbody> <tr> <td>10</td> <td>20</td> </tr> <tr> <td>55</td> <td>6.5</td> </tr> <tr> <td>180</td> <td>0.25</td> </tr> <tr> <td>300</td> <td>0.25</td> </tr> <tr> <td>360</td> <td>0.14</td> </tr> <tr> <td>1000</td> <td>0.14</td> </tr> </tbody> </table>	Frequency (Hz)	PSD (m/s ²) ² /Hz	10	20	55	6.5	180	0.25	300	0.25	360	0.14	1000	0.14
	Frequency (Hz)	PSD (m/s ²) ² /Hz													
	10	20													
	55	6.5													
	180	0.25													
300	0.25														
360	0.14														
1000	0.14														
Equivalent to 27.8 (m/s ²)rms															
Direction:	X Y Z axis														
Duration:	8 hours / each axis TOTAL = 8hoursX3axis=24 hours														
Test Standard:	ISO 16750														

Inspection items:

- Visual inspection before and after test
- Functional inspection before and after test
- Electrical test

LTE



Wi-Fi



GPS

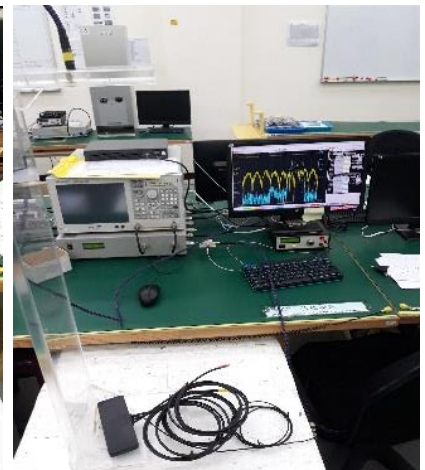

9.4 Test Setup

X axis



Y axis

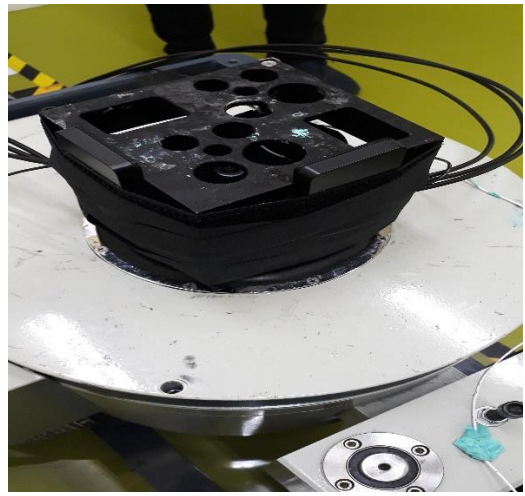

Z axis



Test Profile

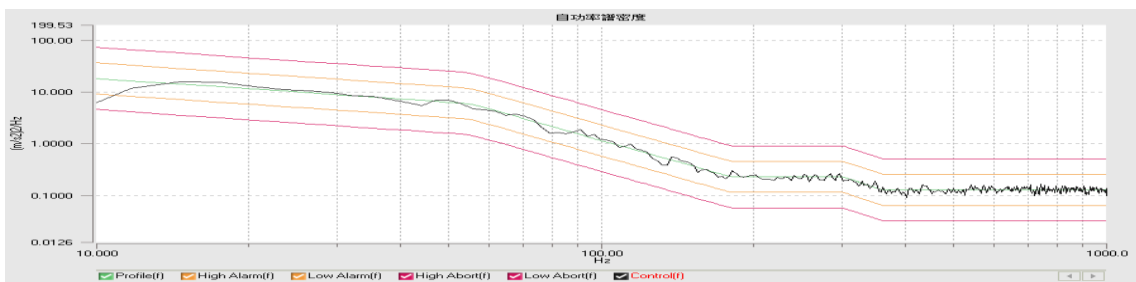

9.5 Test Results

Visual Inspection

Item No./Part No.	Visual Inspection Result	PASS/FAIL
Vibration 1	No visible damage	PASS
Vibration 2	No visible damage	PASS



LTE1							
Criteria (VSWR)	<2.2	>5	<2.8	<2.8	<2.8	PASS/FAIL	
Frequency	900MHZ	1105MHZ	1710MHZ	2170MHZ	2700MHZ	PASS/FAIL	
Vibration 1	Before	1.3347	7.0476	2.6222	1.4834	1.6754	PASS
	After	1.1472	7.2373	1.6731	1.5361	2.1083	
Vibration 2	Before	1.9120	6.4033	2.1130	1.5582	2.1467	PASS
	After	1.5809	5.4005	1.6619	1.2008	2.1523	

LTE2							
Criteria (VSWR)	<2.4	>3	<2.2	<2.1	<2.4	PASS/FAIL	
Frequency	900MHZ	1115MHZ	1710MHZ	2170MHZ	2700MHZ	PASS/FAIL	
Vibration 1	Before	1.9251	7.2172	1.5013	1.4896	1.7385	PASS
	After	1.4965	7.0566	1.7504	1.3874	1.5214	
Vibration 2	Before	1.8827	7.6574	2.0452	1.5664	1.8541	PASS
	After	1.6043	7.4674	1.5320	1.4418	1.7818	

Wi-Fi						
Criteria (VSWR)	>5	<2.2	<2.1	<2.4	<2.8	
Frequency	1000MHz	2400MHz	2500MHz	5150MHz	5850MHz	PASS/FAIL
Vibration 1	Before	10.0216	1.3117	1.3304	1.3167	PASS
	After	8.9460	1.2674	1.4397	1.3442	
Vibration 2	Before	10.3904	1.4363	1.5880	1.7094	PASS
	After	8.9847	1.4832	1.4731	1.3257	

GPS						
Criteria(dB)		S11<-10	S11<-10	S11<-10	1-18mA	
Frequency		1561MHz	1575.42MHz	1602MHz	Current: mA	PASS/FAIL
Vibration 1	Before	-16.3506	-31.1750	-29.3838	10.850	PASS
	After	-18.2042	-26.1143	-19.0034	11.840	
Vibration 2	Before	-16.1836	-34.4040	-22.2276	11.360	PASS
	After	-16.7525	-19.5971	-28.7449	11.450	
Criteria(dB)		-8<S12<6	-7<S12<8	-11<S12<4		
Frequency		1561MHz	1575.42MHz	1602MHz		PASS/FAIL
Vibration 1	Before	-7.5716	-4.1983	-7.5066		PASS
	After	-3.2787	-3.4108	-6.2810		
Vibration 2	Before	-7.3068	-4.3941	-5.6974		PASS
	After	-5.0373	-1.8334	-10.0224		

9.6 VNA Results

LTE1 & 2

Before Test

After Test

Vibration 1

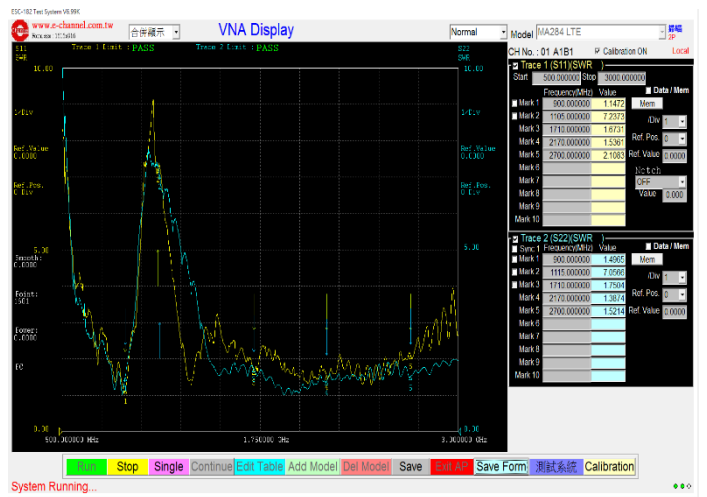
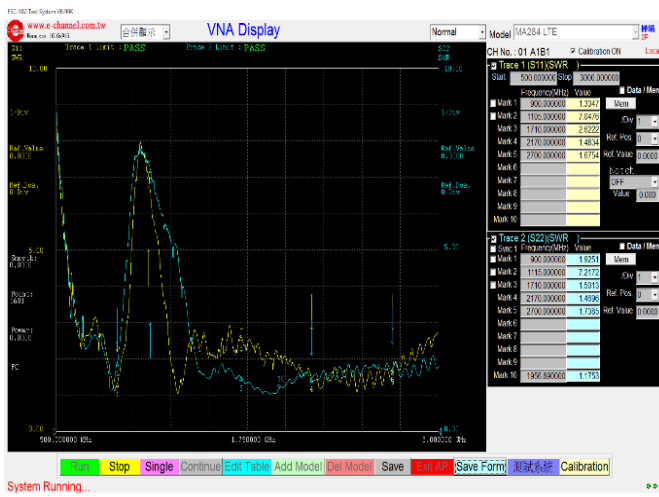

Vibration 2

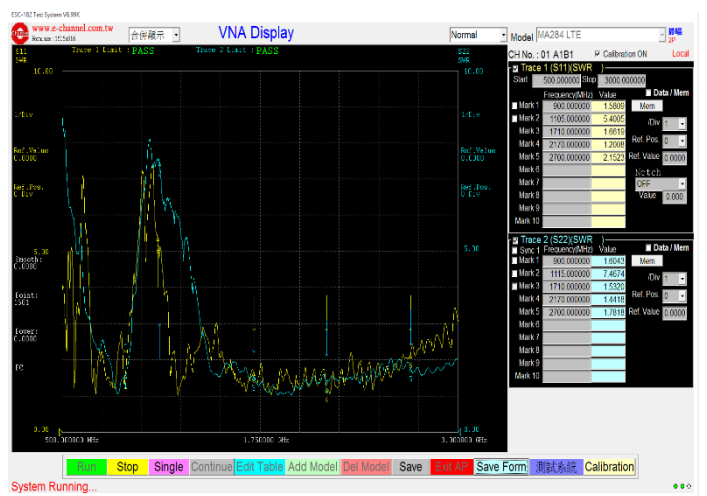
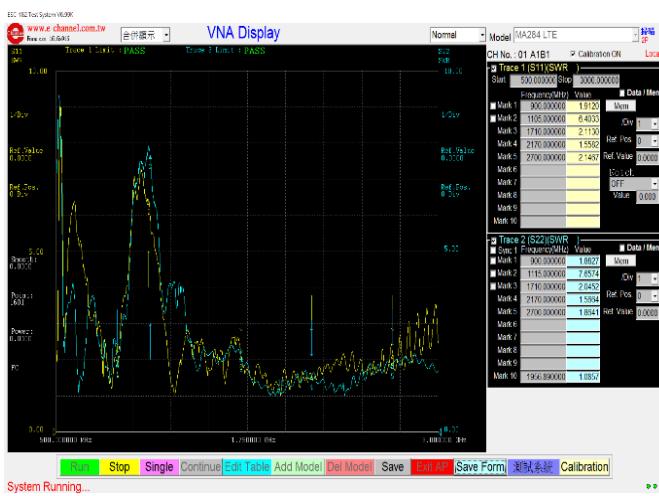

Wi-Fi

Before Test

After Test

Vibration 1

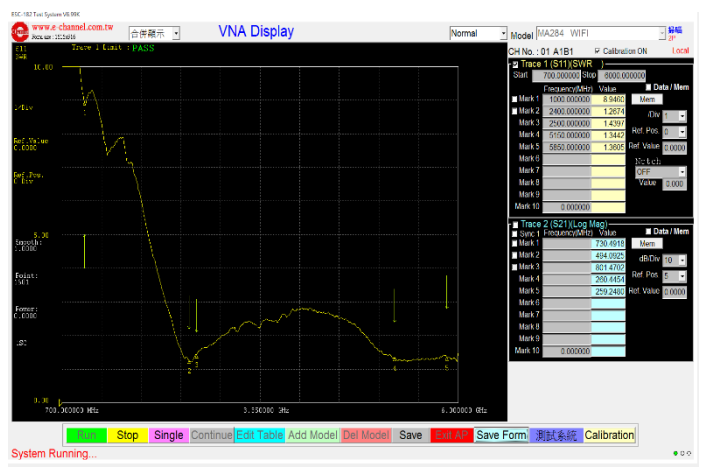
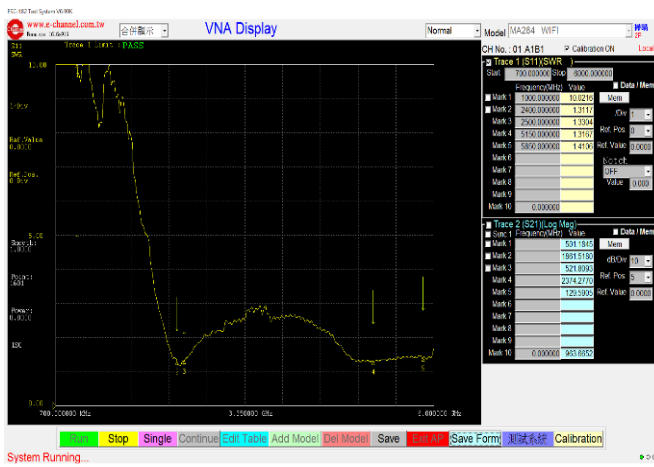

Vibration 2

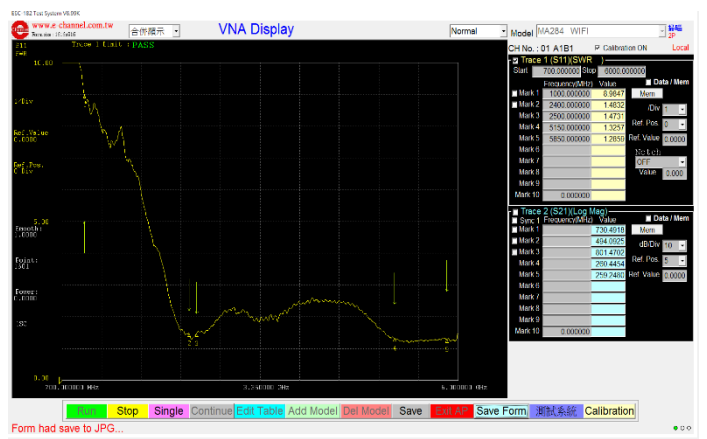
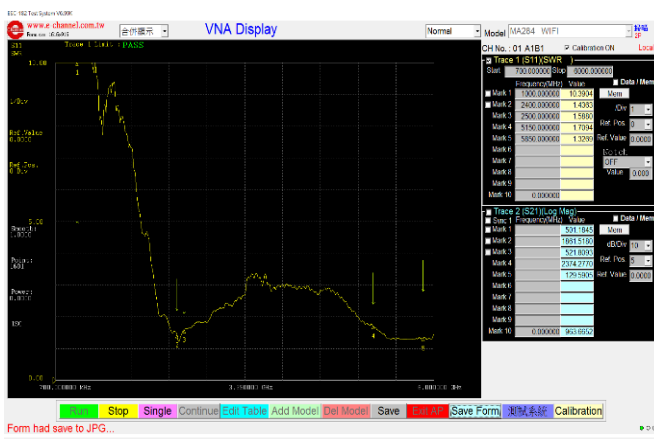

GPS

Before Test

After Test

Vibration 1

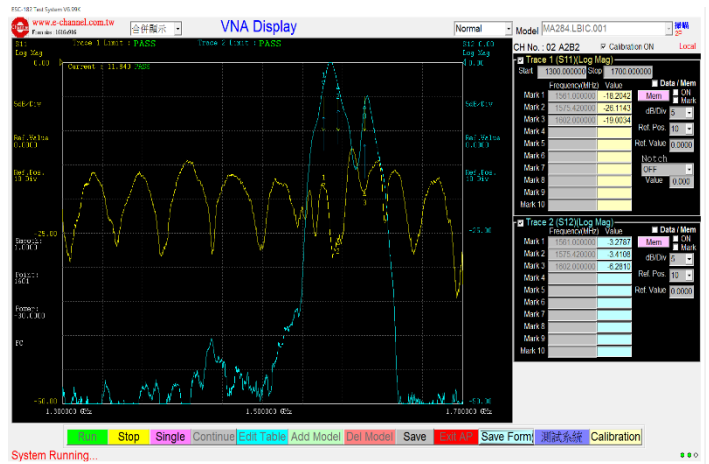
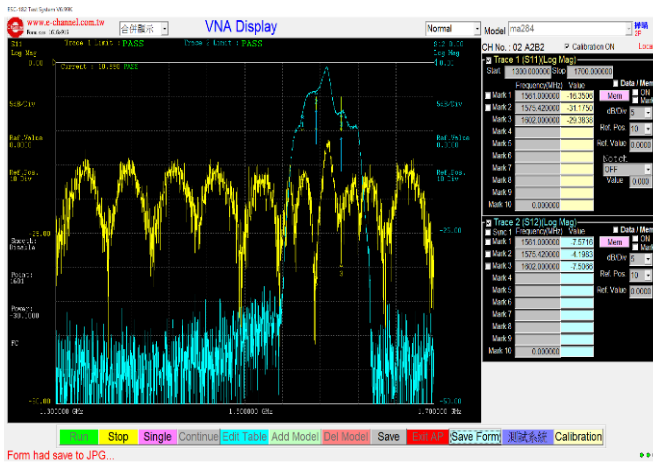

Vibration 2

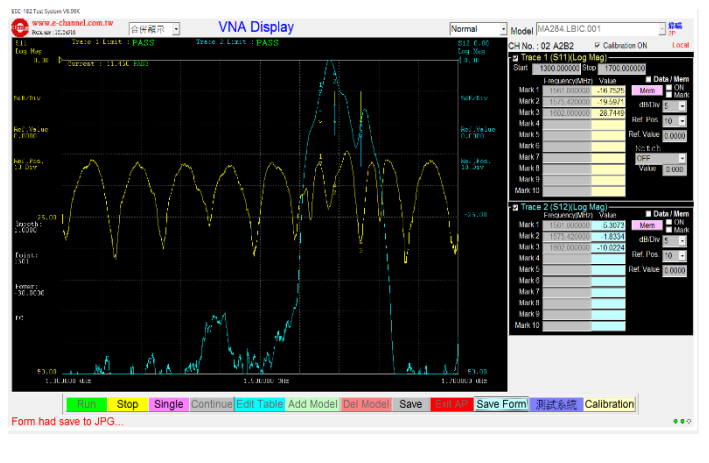
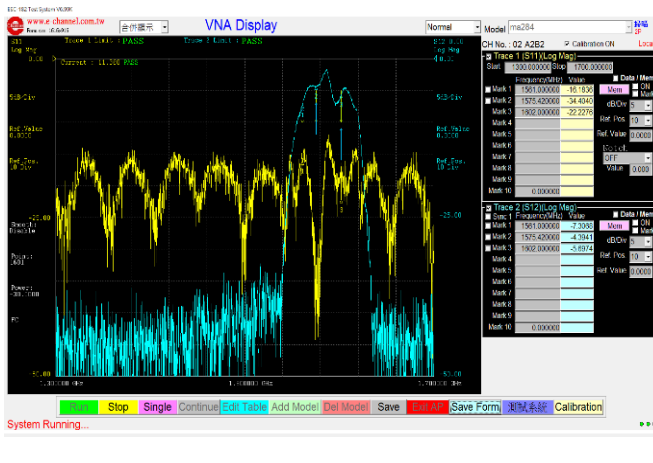

9.7 Conclusion

The Vibration test result for MA284.LBIC.001 was a PASS

Visual Inspection Result: PASS

Electrical test: PASS

Test method: Frequency: 10~1000Hz / Direction: X axis / Duration: 8 hours , each axis

(Total = 8hoursX 3 axis=24 hours)

Frequency (Hz)	PSD (m/s ²) ² /Hz
10	20
55	6.5
180	0.25
300	0.25
360	0.14
1000	0.14
Equivalent to 27.8 (m/s ²)rms	

10. Mechanical Shock Test

Product Category:	Antenna
Product Series Name:	Genesis II
Product Model Part No.:	MA284.LBIC.001
Quantity Tested:	2 pcs
Date of Testing:	03/13-14 , 2019
Test Required:	Mechanical Shock Test
Batch No:	(SWEI001)

10.1 Test Equipment

<i>Name</i>	<i>Brand</i>	<i>Model</i>	<i>Serial No.</i>	<i>Calibration Date</i>
Vibration test system	Vibration-Source	VS-300V	E00404	2018/08/07
Controller	V5.0	Super-2	243552379	2018/08/07
Network Analyzer	KEYSIGHT	E5071C	MY46526857	2018/12/23

10.2 Lab Environmental Conditions

Ambient Temperature	25±3°C
Relative Humidity	65±20%RH

10.3 Test Method/Specification

Sample condition:	Unpacked
Pulse Shape:	Half Sinusoidal
Acceleration:	50G
Pulse Duration:	6ms
Shock Direction:	±X, ±Y, ±Z, 6axis
Times:	10 shocks/Axis, total=60 shocks
Test standard	ISO 16750

Inspection items:

- Visual inspection before and after test
- Functional inspection before and after test.

10.4 Test Setup



10.5 Test Results

Test	Visual Inspection Result	PASS/FAIL
Shock	No visible damage	PASS

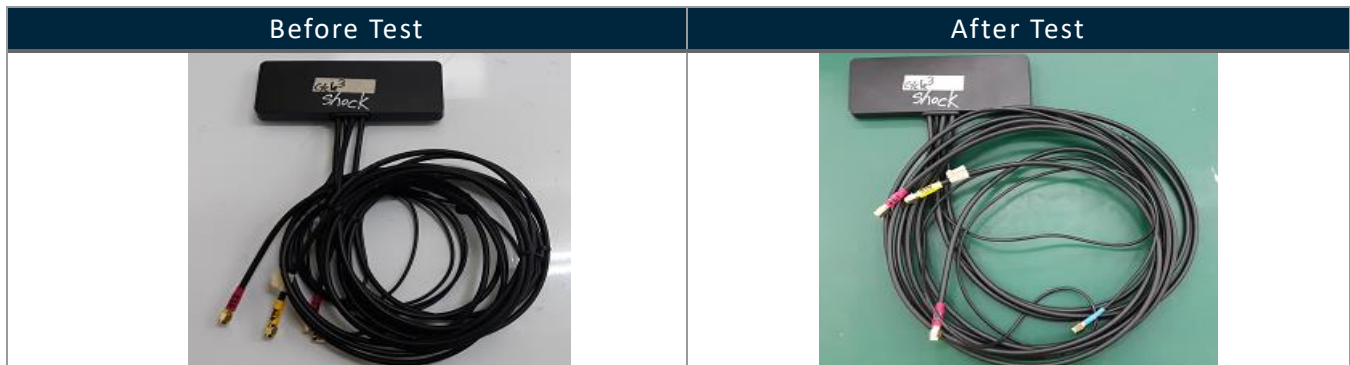

LTE1						
Criteria (VSWR)	<2.2	>5	<2.8	<2.8	<2.8	
Frequency	900MHz	1105MHz	1710MHz	2170MHz	2700MHz	PASS/FAIL
Before	1.4541	7.1812	1.5995	1.1837	2.0464	PASS
After	1.9596	6.5141	1.9945	1.2279	1.5090	
LTE2						
Criteria (VSWR)	<2.4	>3	<2.2	<2.1	<2.4	
Frequency	900MHz	1115MHz	1710MHz	2170MHz	2700MHz	PASS/FAIL
Before	1.5062	7.7703	1.5716	1.4493	1.8727	PASS
After	2.1882	6.8598	1.4510	1.4735	1.7561	
Wi-Fi						
Criteria (VSWR)	>5	<2.2	<2.1	<2.4	<2.8	
Frequency	1000MHz	2400MHz	2500MHz	5150MHz	5850MHz	PASS/FAIL
Before	10.0889	1.2495	1.5280	1.4056	1.3422	PASS
After	9.5431	1.3953	1.3000	1.3563	1.4295	
GPS						
Criteria(dB)	S11<-10	S11<-10	S11<-10	1-18mA		
Frequency	1561MHz	1575.42MHz	1602MHz	Current Unit :mA		PASS/ FAIL
Before	-19.5439	-20.3237	-30.2115	10.920	PASS	
After	-23.4871	-20.7000	-16.9670	11.340		
Criteria(dB)	-8<S12<6	-7<S12<8	-11<S12<4			
Frequency	1561MHz	1575.42MHz	1602MHz			PASS/ FAIL
Before	-7.4385	-3.9109	-4.5607	PASS		
After	-4.9585	2.4792	-5.1544			

LTE1 & 2

Before Test

After Test

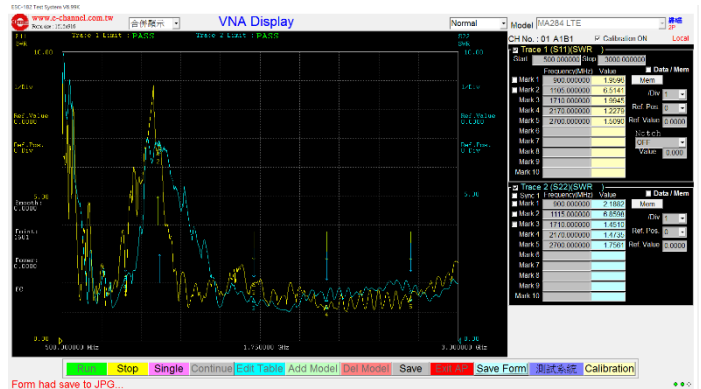
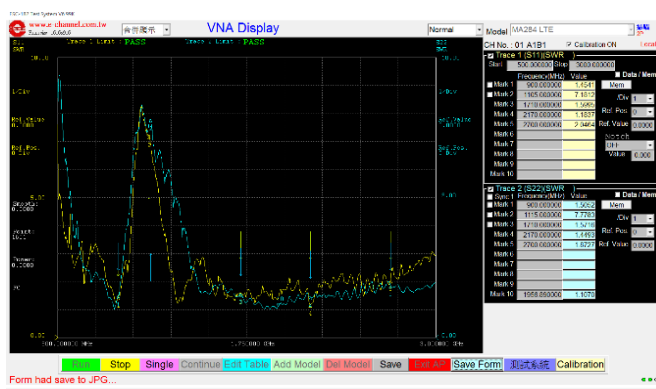

Wi-Fi

Before Test

After Test

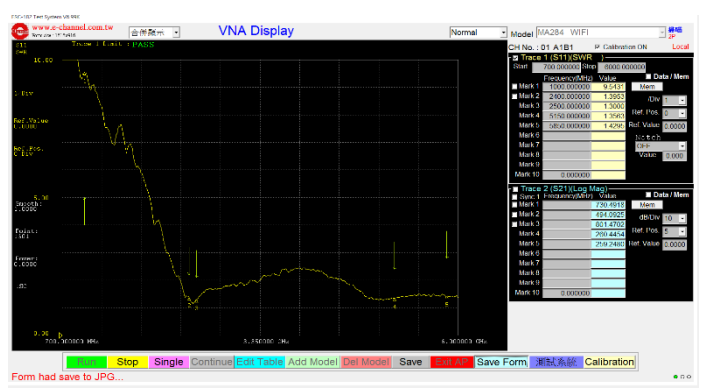
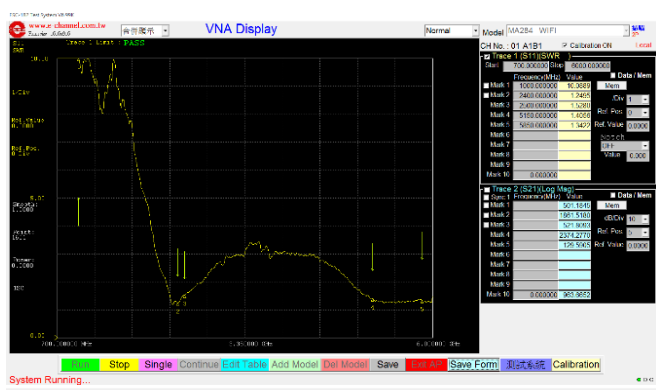

GPS

Before Test

After Test

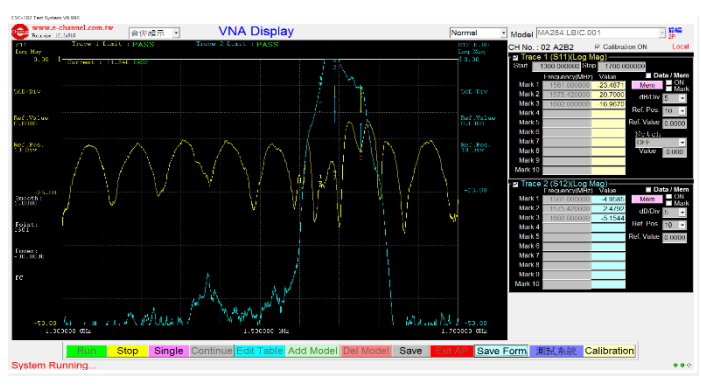
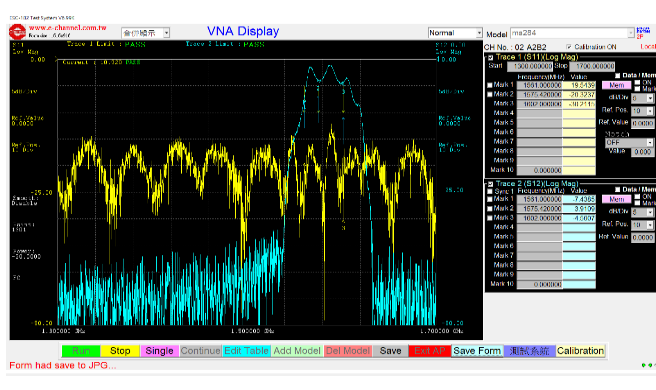

10.6 Conclusion

The Mechanical Shock test result for MA284.LBIC.001 was a PASS

Visual inspection: PASS

Electrical inspection: PASS

Sample condition:	Unpacked
Pulse Shape:	Half Sinusoidal
Acceleration:	50G
Pulse Duration:	6ms
Shock Direction:	±X, ±Y, ±Z, 6axis
Times:	10 shocks/Axis, total=60 shocks
Test standard	ISO 16750

11. Drop Test

Test Report Taoglas Taiwan Reliability Test Lab

Product Category:	Antenna
Product Model Part No.:	MA284.LBIC.001
Quantity Tested:	1 pc
Date of Testing:	03/11 , 2019
Test Required:	Drop Test
Batch No:	(SWEI001)

Product picture:



1. Test Equipment

Name	Brand	Model	Serial No.	Calibration Date
Network Analyzer	KEYSIGHT	E5071C	MY46526857	2018/12/13

2. Lab Environmental Conditions:

Ambient temperature: 25±3°C

Relative humidity: 65±20%RH

3. Test Method/Specification

Sample condition:	Unpacked
Fall Height:	1 M
Test times	1 time/each test
Test set:	Ground
Test Standard:	Follow Taoglas' Reliability Test Operation Procedure

Inspection items:

- Visual inspection before and after test
- Functional inspection before and after test

Test Equipment Set-up

Drop test photo



6 faces drop test photo



FACE A

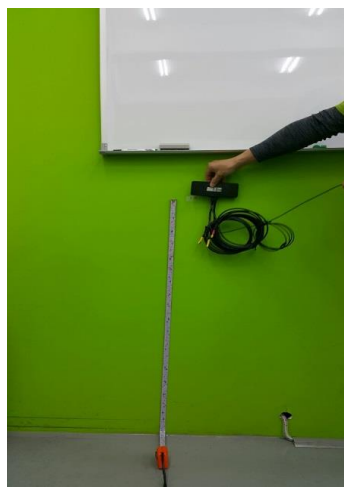

FACE B

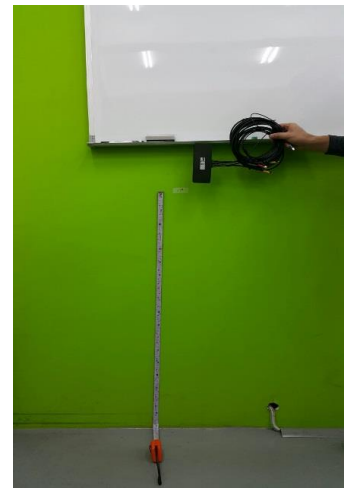

FACE C

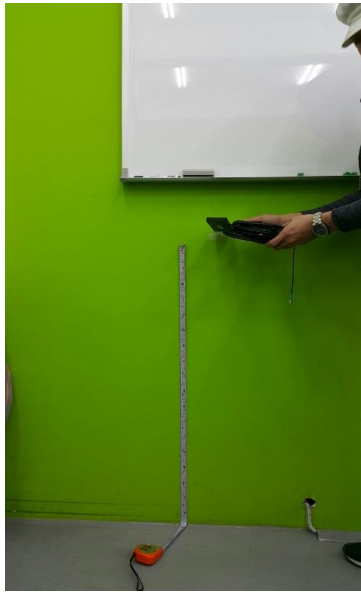

FACE D



FACE E



FACE F

Angle 1

Angle 1 test photo



Axis 2

3 Axis test photo:



Axis 1

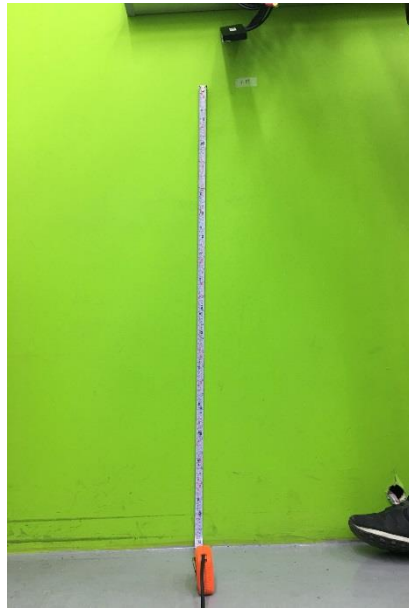

Axis 2



Axis 3

4. Test Results

4.1. Visual Inspection

Item No./Part No.	Visual Inspection Result	PASS/FAIL
Sample 1	No visible damage or break	PASS

4.2. Test Picture

Before Test

After Test

SAMPLE 1



4.3. Functional Inspection

LTE1							
Criteria(VSWR)		<2.2	>5	<2.8	<2.8	<2.8	
Part No./ Sample No.		900MHz	1105MHz	1710MHz	2170MHz	2700MHz	PASS/FAIL
Sample 1	Before	1.2210	7.3961	2.1198	1.2980	2.5111	PASS
	After	1.4451	7.9390	1.8249	1.5937	2.6301	

LTE2							
Criteria(VSWR)		<2.4	>3	<2.2	<2.1	<2.4	
Part No./ Sample No.		900MHz	1115MHz	1710MHz	2170MHz	2700MHz	PASS/FAIL
Sample 1	Before	1.7324	7.0355	1.8092	1.6304	1.4320	PASS
	After	1.9199	7.3320	1.7001	1.7662	1.3798	

WIFI1							
Criteria(VSWR)		>5	<2.2	<2.1	<2.4	<2.8	
Part No./ Sample No.		1000MHz	2400MHz	2500MHz	5150MHz	5850MHz	PASS/FAIL
Sample 1	Before	9.0964	1.3290	1.7865	1.3550	1.3672	PASS
	After	8.8443	1.2898	1.6789	1.2678	1.2600	

WIFI2							
Criteria(VSWR)		>5	<2.2	<2.1	<2.4	<2.8	
Part No./ Sample No.		1000MHz	2400MHz	2500MHz	5150MHz	5850MHz	PASS/FAIL
Sample 1	Before	9.9164	1.4077	1.5340	1.5580	1.3856	PASS
	After	9.4661	1.3840	1.5516	1.4238	1.4693	

GNSS						
	Criteria(dB)	S11<-10	S11<-10	S11<-10	1-18mA	
Part No./ Sample No.	Before /After	1561MHz	1575.42MHz	1602MHz	Current Unit :mA	PASS/FAIL
Sample 3	Before	-15.8166	-14.2037	-14.4567	11.750	PASS
	After	-20.2241	-26.3585	-23.0684	11.750	PASS
	Criteria(dB)	-8<S12<6	-7<S12<8	-11<S12<4		
Part No./ Sample No.	Before /After	1575.42MHz	1575.42MHz	1602MHz		PASS/ FAIL
Sample 3	Before	-5.2258	0.1317	-5.5774		PASS
	After	-4.9625	-1.7349	-6.4786		PASS

4.4. Function test photo

LTE1 & 2

Before Test

After Test

SAMPLE 1

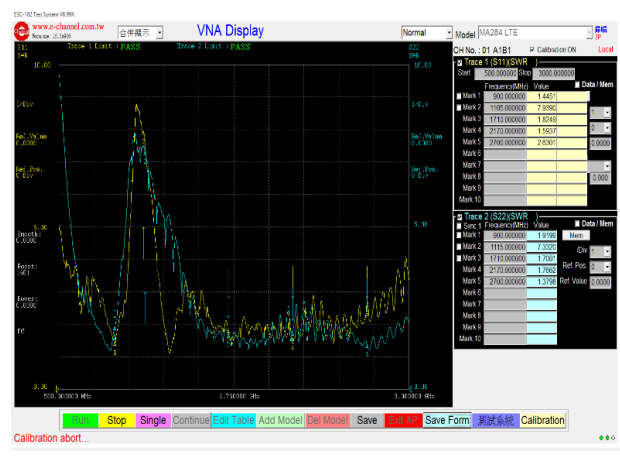
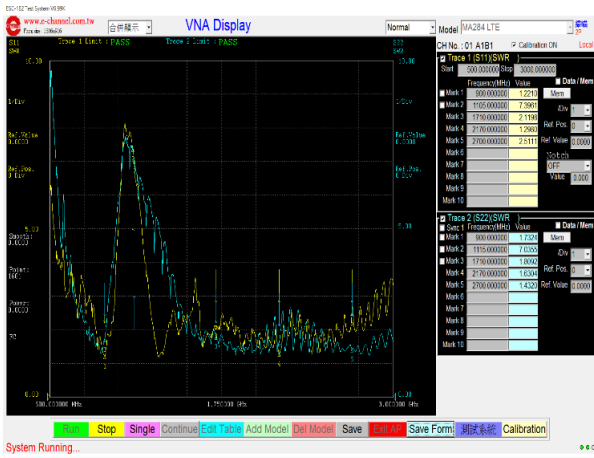

Wi-Fi 1

Before Test

After Test

SAMPLE 1

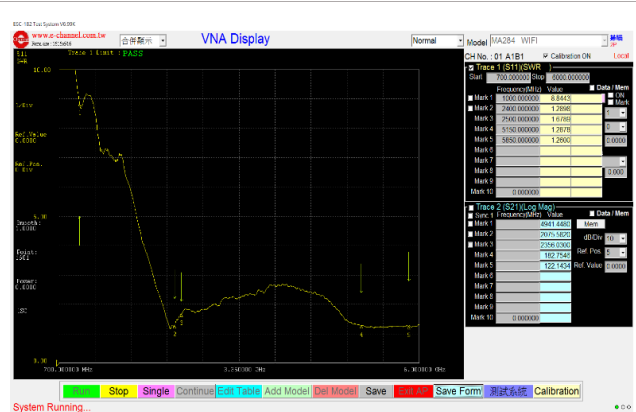
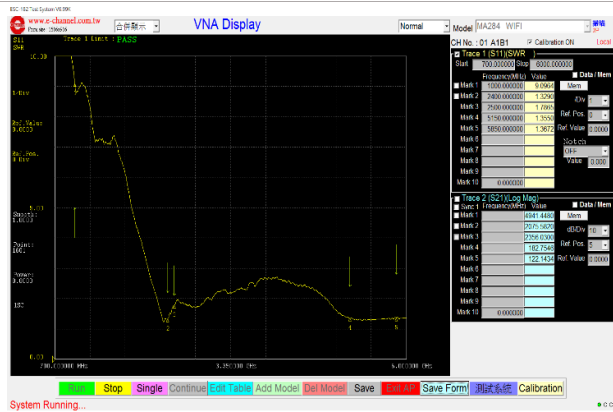

Wi-Fi 2

Before Test

After Test

SAMPLE 1

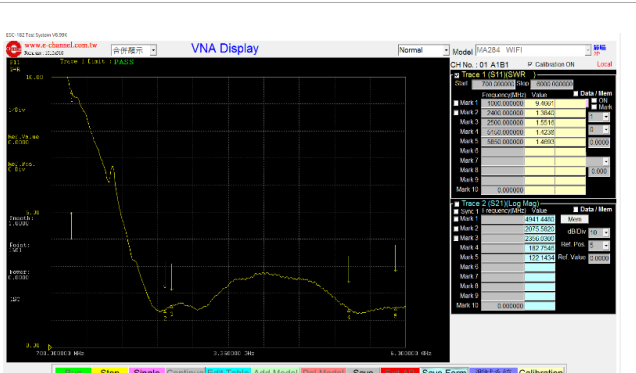
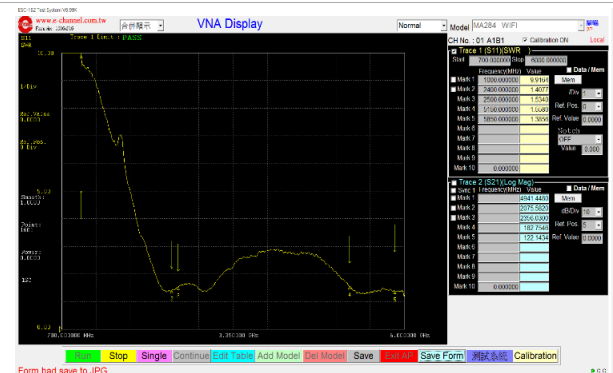

5. Conclusion

5.1. The drop test result for MA284.LBIC.001 shows PASS

Visual inspection:	PASS
Electrical test:	PASS

5.2. Test method: Follow Taoglas' Reliability Test Operation Procedure

Fall Height:	1 M
Test times:	1 time/each test
Test set:	Ground

Changelog for the datasheet

SPE-19-8-009 – MA284.LBIC.001

Revision: B (Current Version)

Date:	2020-02-12
Notes:	Updated to include some 5G bands
Author:	Jack Conroy

Previous Revisions

Revision: A (Original First Release)

Date:	2019-01-28
Notes:	Initial Datasheet Release
Author:	Yu Kai Yeung



TAOGLAS®

www.taoglas.com



X-ON Electronics

Largest Supplier of Electrical and Electronic Components

Click to view similar products for [Antennas](#) category:

Click to view products by [Taoglas](#) manufacturer:

Other Similar products are found below :

[GAN30084EU](#) [930-033-R](#) [GW17.07.0250E](#) [1513563-1](#) [EXE902SM](#) [APAMPG-117](#) [MAF94383](#) [W3908B0100](#) [W6102B0100](#) [YE572113-30RSMM](#) [108-00014-50](#) [66089-2406](#) [SPDA17RP918](#) [A09-F8NF-M](#) [A09-F5NF-M](#) [RGFRA1903041A1T](#) [W3593B0100](#) [W3921B0100](#) [SIMNA-868](#) [SIMNA-915](#) [SIMNA-433](#) [W1044](#) [W1049B090](#) [A75-001](#) [WTL2449CQ1-FRSMM](#) [CPL9C](#) [EXB148BN](#) [0600-00060](#) [TRA9020S3PBN-001](#) [Y4503](#) [GD5W-28P-NF](#) [MA9-7N](#) [GD53-25](#) [GD5W-21P-NF](#) [C37](#) [MAF94051](#) [MA9-5N](#) [EXD420PL](#) [B1322NR](#) [QWFTB120](#) [MAF94271](#) [MAF94300](#) [GPSMB301](#) [FG4403](#) [AO-AGSM-OM54](#) [5200232](#) [MIKROE-2349](#) [WCM.01.0111](#) [MIKROE-2393](#) [MIKROE-2352](#)