

SPECIFICATION

Part No.	:	MAT.500.A
Product Name	:	MAT.500 Embedded Antenna Board 6in1 for Telematics Devices LTE MIMO + GPS/GLONASS + Satellite L Band 1621MHz
Features	:	2* LTE MIMO 698-960MHz/1710-2170MHz/ 2490-2690MHz/3300-3600MHz 2* Wi-Fi MIMO 2.4GHz/5.8GHz 1* GPS-GLONASS Antenna 1* Satellite L Band 1621MHz Antenna Worldwide 4G Bands including 3G and 2G Dims: 157.32*103.19*30mm IPEX connectors, 1.37mm cables RoHS Compliant

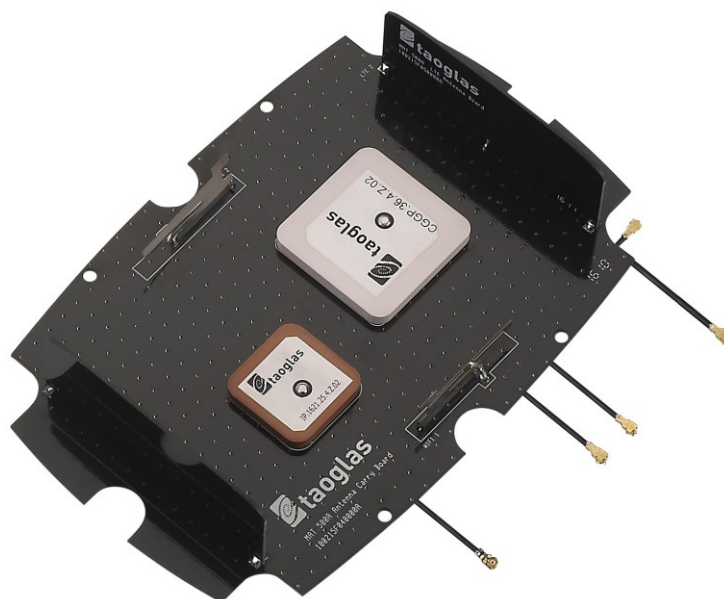

1. Introduction

The MAT.500.A embedded antenna board combines LTE MIMO antennas, Wi-Fi MIMO antennas, plus GPS/GLONASS and Iridium[®] 1621MHz antennas. It can be used as a reference design or actual embedded antenna for telematics devices in applications such as fleet management, asset tracking, and security/surveillance.

The board comes with six IPEX connectors and 1.37mm coax cables for LTE, Wi-Fi, GPS/GLONASS and Iridium 1621MHz.

Typical applications:

- High speed data links with a need for satellite communication as fallback
- Automotive and Heavy Equipment Vehicle Tracking and Telematics
- Remote Asset and Pipeline Monitoring
- HD Video over LTE
- First Responder and Emergency Services
- Global data communications/IoT

LTE 4G applications demand high speed data uplink and downlink. High efficiency and high gain MIMO antennas are necessary to achieve the required signal to noise ratio and throughput required to solve these challenges. Taoglas also takes care to have high isolation between the two MIMO antennas to prevent self-interference. Low loss cables are used to keep efficiency high over long cable lengths. The GPS-GLONASS passive antenna receives efficiently on all two bands, leading to higher location accuracy and stability of tracking in urban environments.

The unique omnidirectional Wi-Fi antennas provide high efficiency and high isolation between antenna elements in a heavy-duty low profile compact structure, delivering powerful MIMO antenna technology for Wi-Fi 802.11n and emerging 802.11ac.

Finally, a low axial ratio 1621MHz Antenna is also embedded, providing connectivity for the Iridium satellite system, enabling global coverage, and back-up in case of cellular network failure. Cable length and connector types are customizable. Contact your regional Taoglas sales office for support.

2. Specification (in Reference Housing)

GPS-GLONASS	
Center Frequency	GPS: 1575.42±1.023 MHz GLONASS: 1602±5 MHz
Passive Antenna Efficiency	GPS: 75% GLONASS: 68%
Average gain	GPS: -1.2dBi GLONASS: -1.6dBi
Peak gain	GPS: 5.47dBi GLONASS: 4.9dBi
VSWR	2:1 Max
Impedance	50Ω
Axial Ratio	GPS: < 5.1 GLONASS: < 6.3
Polarization	RHCP
Cable	Ø1.37 Micro Coax. 68mm standard, fully customizable
Connector	IPEX standard, fully customizable

Satellite L-Band 1621MHz	
Center Frequency	Satellite L-Band: 1621±5 MHz
Passive Antenna Efficiency	70%
Average gain	-1.52dBi
Peak gain	5.11dBi
VSWR	2:1 Max
Impedance	50Ω
Axial Ratio	<7.3
Polarization	RHCP
Cable	Ø1.37 Micro Coax. 83mm standard, fully customizable
Connector	IPEX standard, fully customizable

4G/3G/2G LTE Antenna							
Frequency (MHz)	LTE700	GSM850	GSM900	DCS	PCS	UMTS1	LTE2600
	698~803	824~894	880~960	1710~1880	1850~1990	1920~2170	2490~2690
Efficiency (%)							
MIMO_1	44.65	50.40	28.06	68.20	67.23	56.83	33.30
MIMO_2	40.43	35.92	25.54	66.06	60.22	56.20	29.30
Average Gain(dBi)							
MIMO_1	-3.58	-3.04	-5.70	-1.67	-1.74	-2.55	-4.78
MIMO_2	-4.00	-4.60	-5.93	-1.83	-2.21	-2.51	-5.34
Peak Gain(dBi)							
MIMO_1	0.28	1.70	1.70	6.79	7.06	6.81	1.35
MIMO_2	0.55	1.07	-1.42	5.23	5.23	4.64	1.38
Envelope Correlation Coefficient (ECC)				< 0.33			
Impedance				50Ω			
Polarization				Linear			
VSWR				< 4			
Cable				Ø1.37 78mm/MIMO_1,133mm/MIMO_2 standard, fully customizable			
Connector				I-PEX standard , fully customizable			

2.4GHz/5.8GHz Wi-Fi Antenna		
Frequency (MHz)	2400~2500	4900~5850
Efficiency (%)		
MIMO_1	50.51	61.87
MIMO_2	65.72	60.18
Average Gain(dBi)		
MIMO_1	-2.97	-2.10
MIMO_2	-1.84	-2.22
Peak Gain(dBi)		
MIMO_1	5.14	4.77
MIMO_2	5.82	4.96
Impedance		
50Ω		
Polarization		
Linear		
VSWR		
< 2.2		
Cable		
Ø1.37 Micro Coax. 68mm for MIMO_1, 118mm for MIMO_2 standard, fully customizable		
Connector		
I-PEX standard , fully customizable		

MECHANICAL	
Antenna Dimensions	157.32*103.19*30mm
Weight	66g
ENVIRONMENTAL	
Operation Temperature	-40°C to 85°C
Storage Temperature	-40°C to 90°C
Humidity	Non-condensing 65°C 95% RH

3. Antenna Characteristics (In Reference Housing)

3.1 GPS-GLONASS Antenna

3.1.1 Test Setup



3.1.2 GPS-GLONASS Return Loss

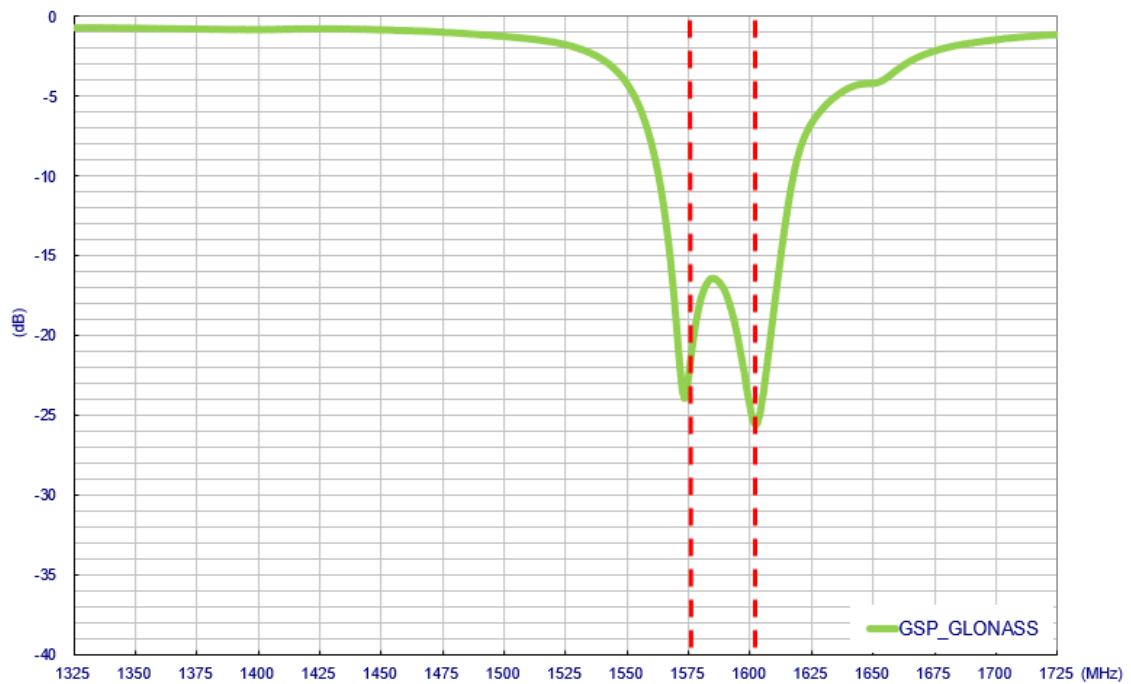

3.1.3 GPS-GLONASS Smith Chart

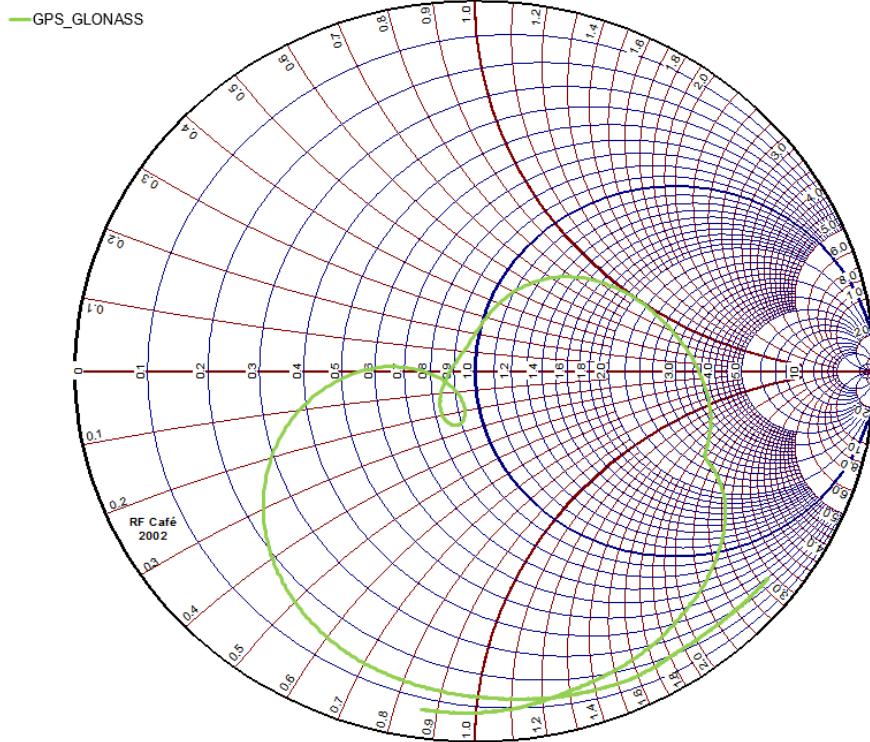

3.1.4 GPS-GLONASS VSWR

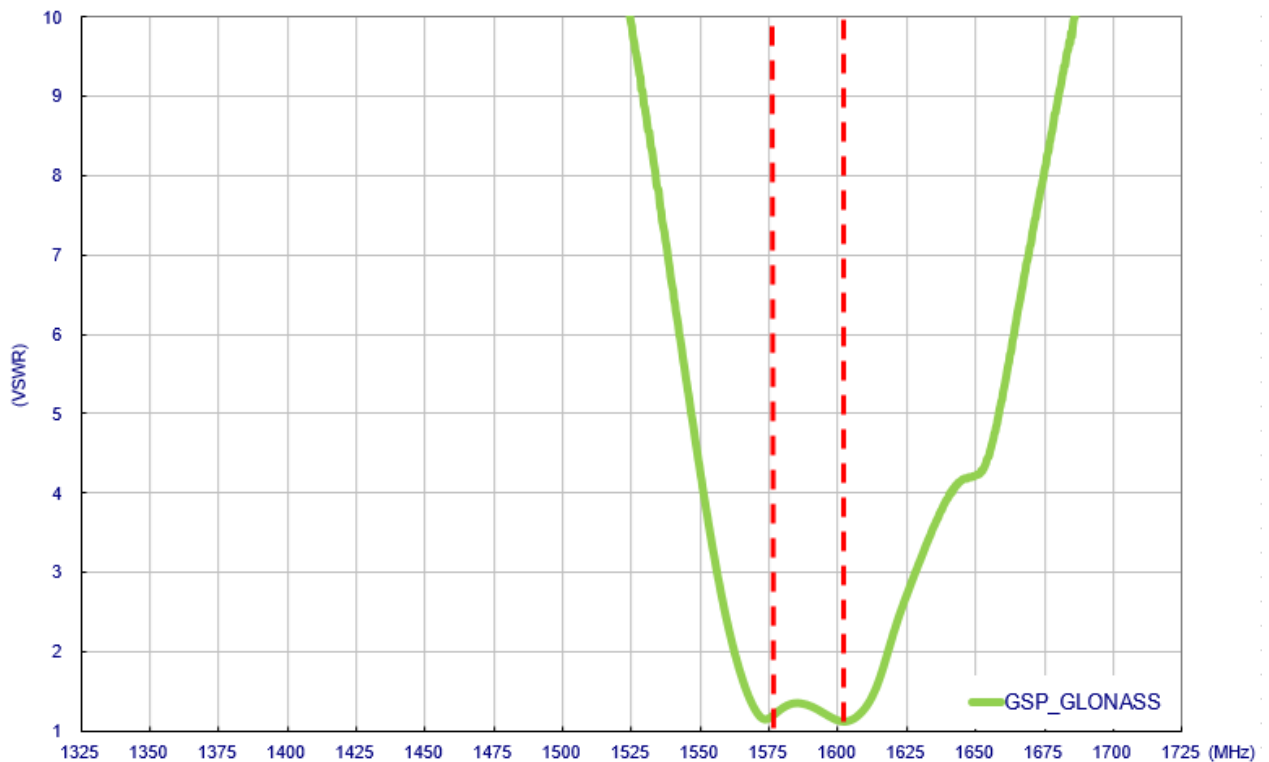

3.1.5 GPS-GLONASS Efficiency

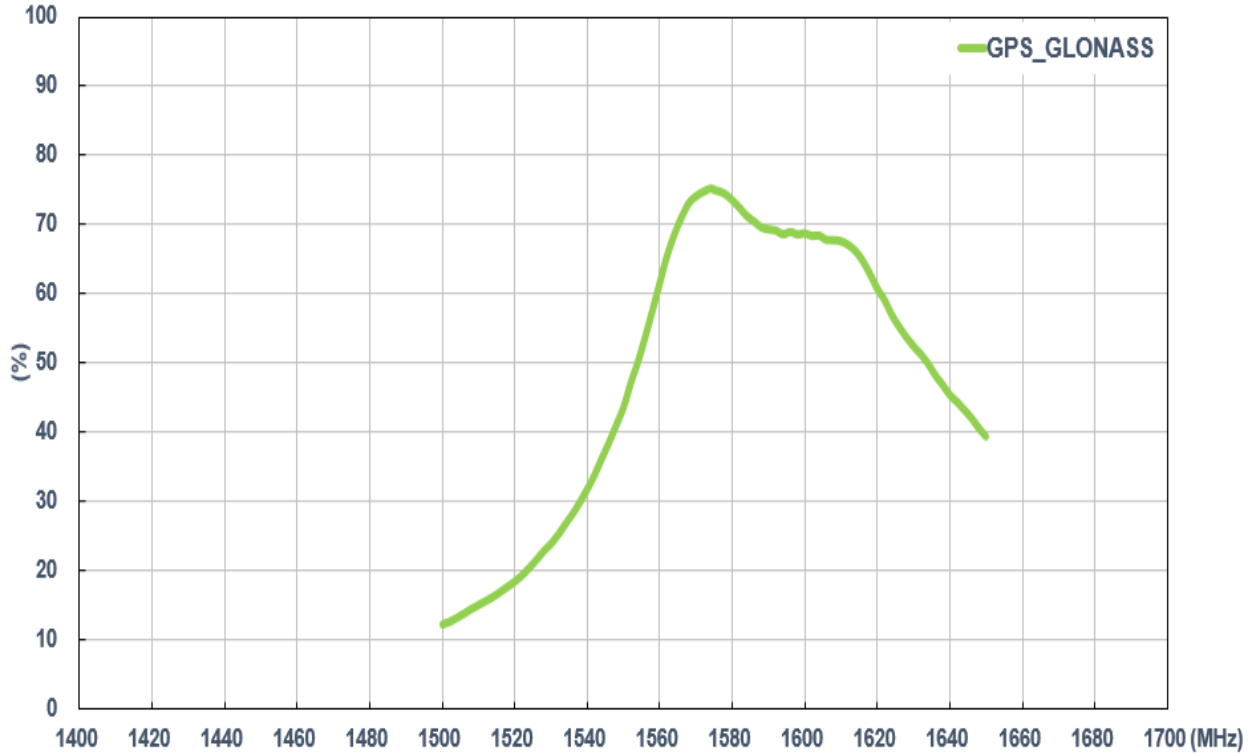

3.1.6 GPS-GLONASS Average gain

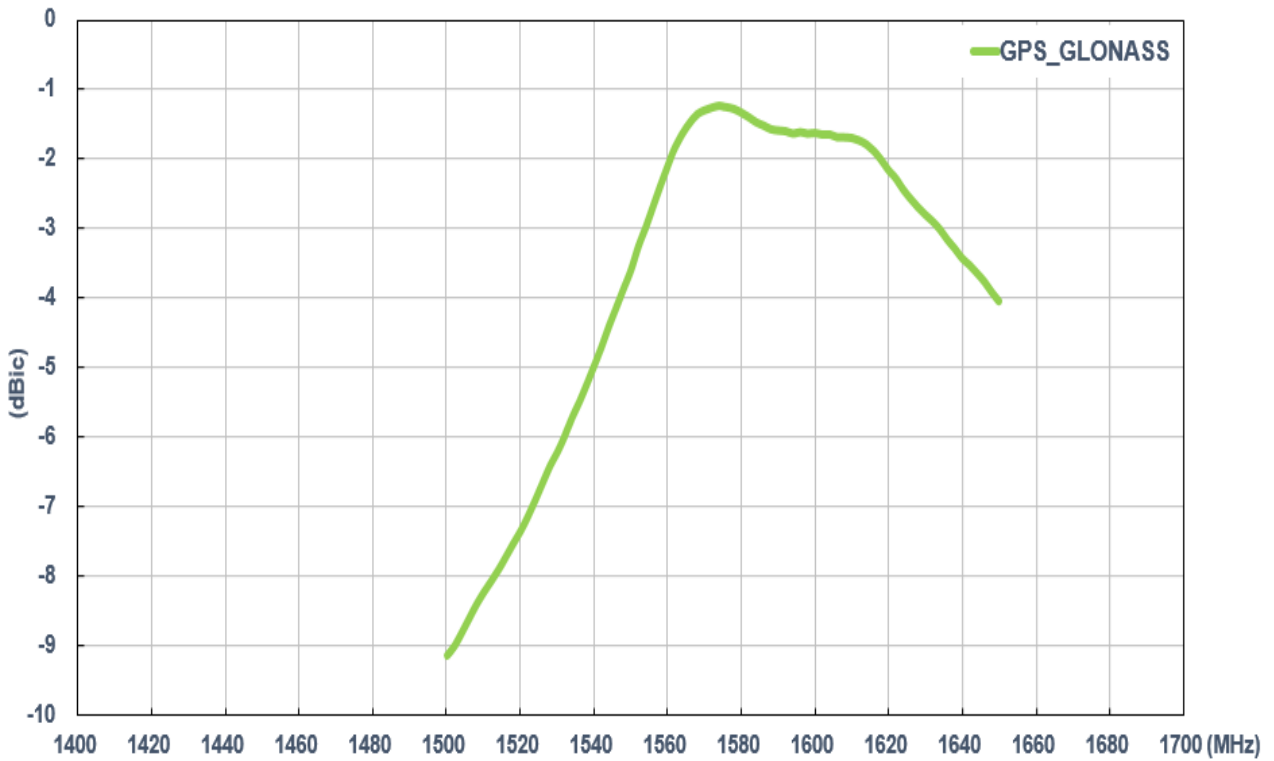

3.1.7 GPS-GLONASS Peak gain

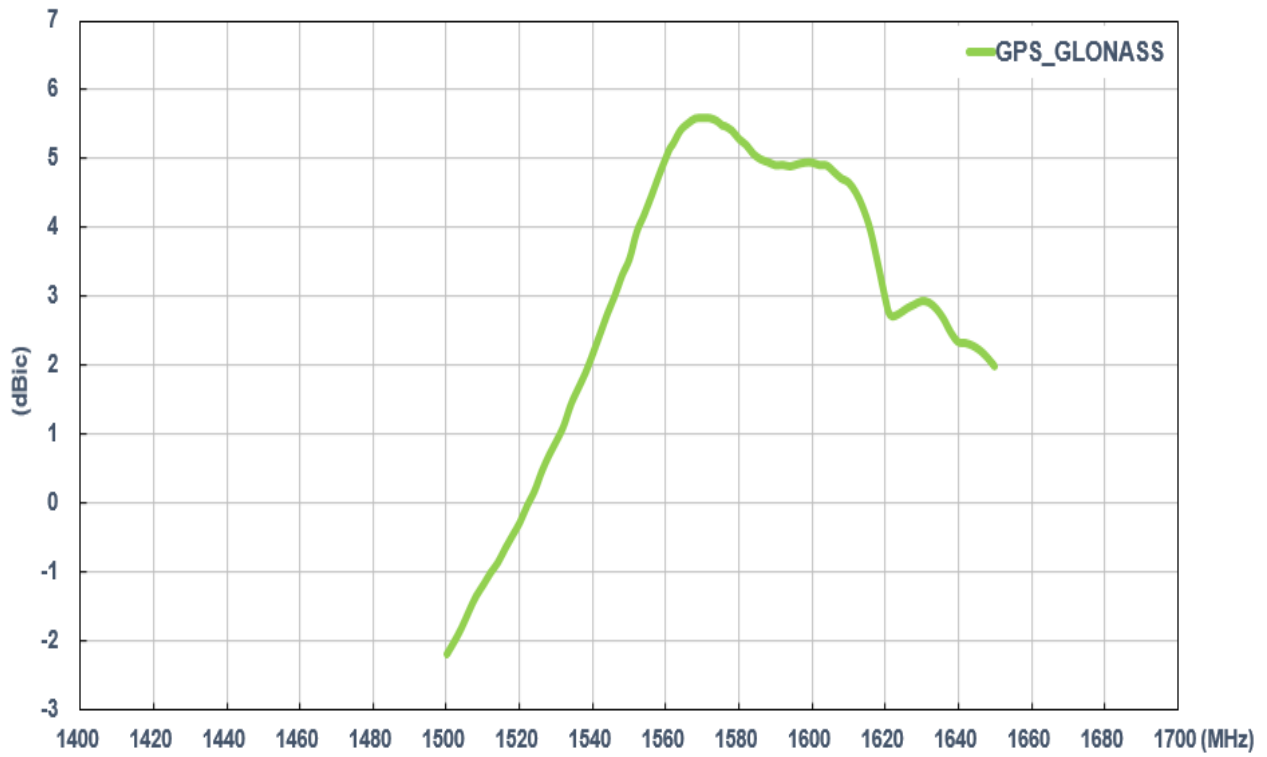

3.1.8 Test Setup For Antenna Radiation Pattern

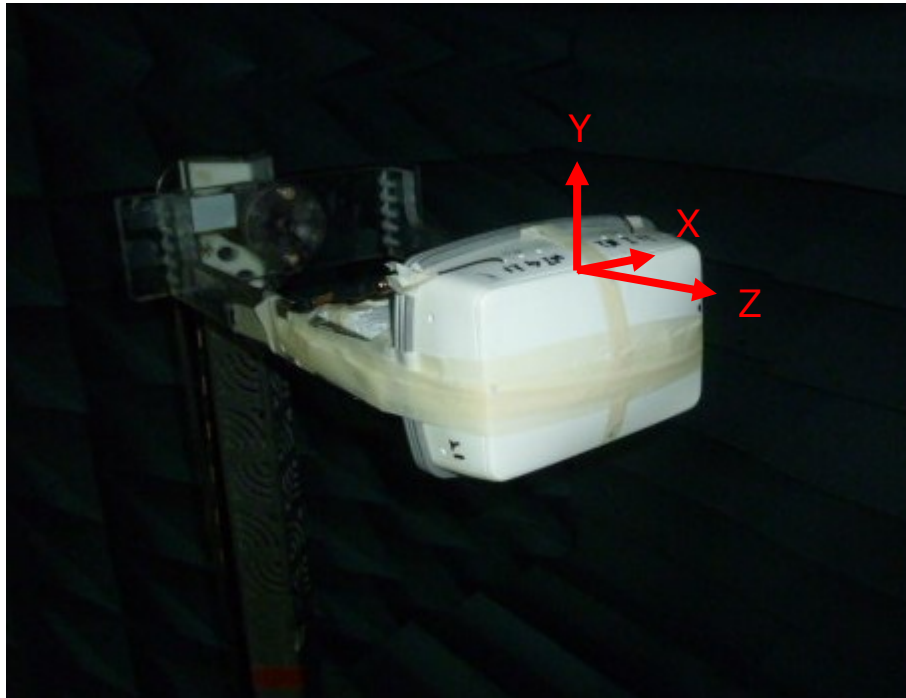

In free space

3.1.9 GPS-GLONASS 2D Radiation Pattern

2D Radiation Pattern @ 1575.42MHz

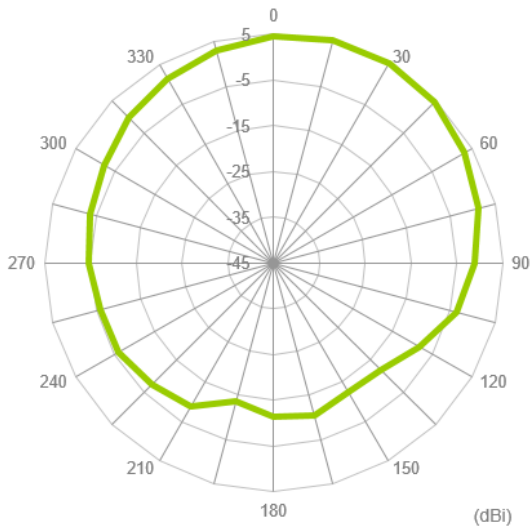

XZ Plane ($\phi=0^\circ$, $\Theta=0\sim 360^\circ$)

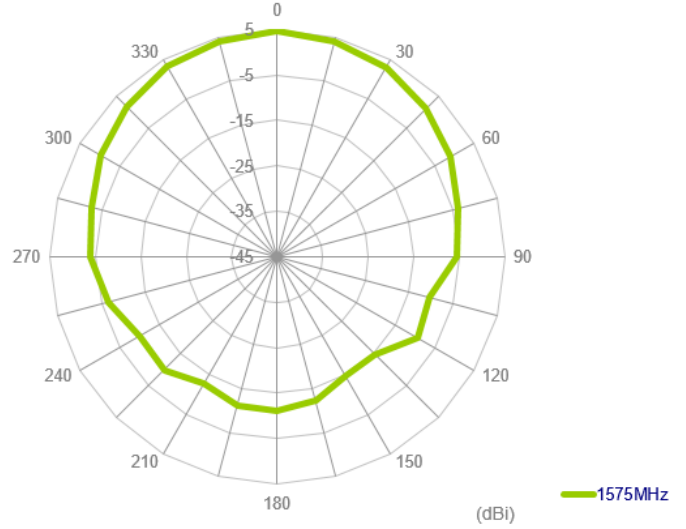

YZ Plane ($\phi=90^\circ$, $\Theta=0\sim 360^\circ$)

3.1.10 GPS-GLONASS 3D Radiation Pattern

3D Radiation pattern @ 1575.42MHz

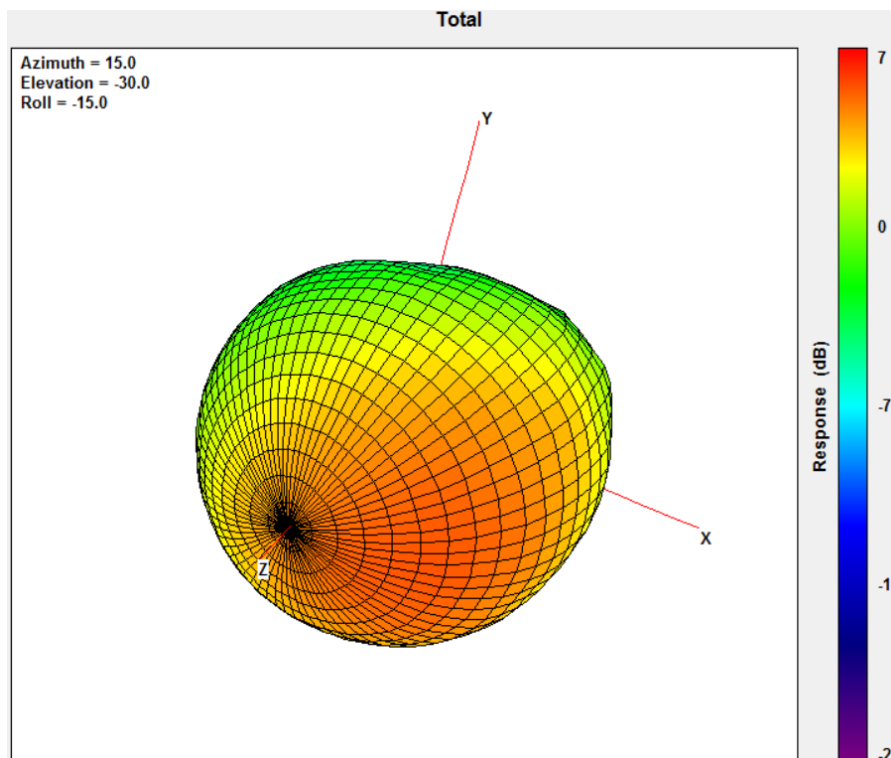

3.1.11 GPS-GLONASS 2D Radiation Pattern

2D Radiation pattern @ 1602MHz

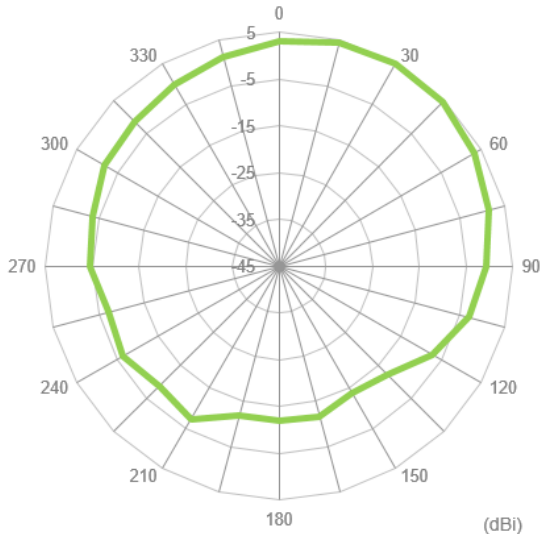

XZ Plane ($\phi=0^\circ$, $\Theta=0\sim 360^\circ$)

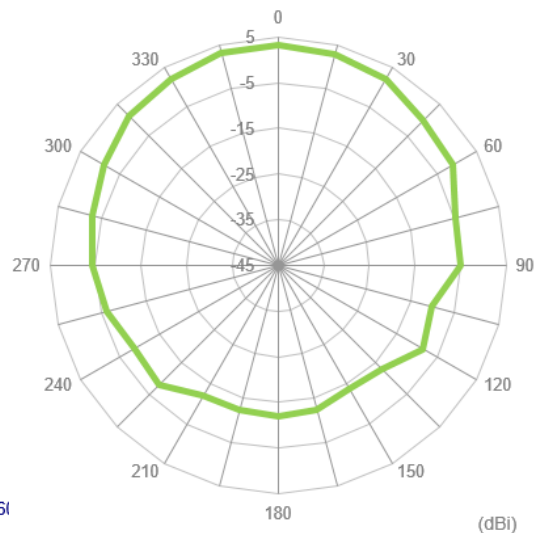

YZ Plane ($\phi=90^\circ$, $\Theta=0\sim 360^\circ$)

3.1.12 GPS-GLONASS 3D Radiation Pattern

3D Radiation pattern @ 1602MHz

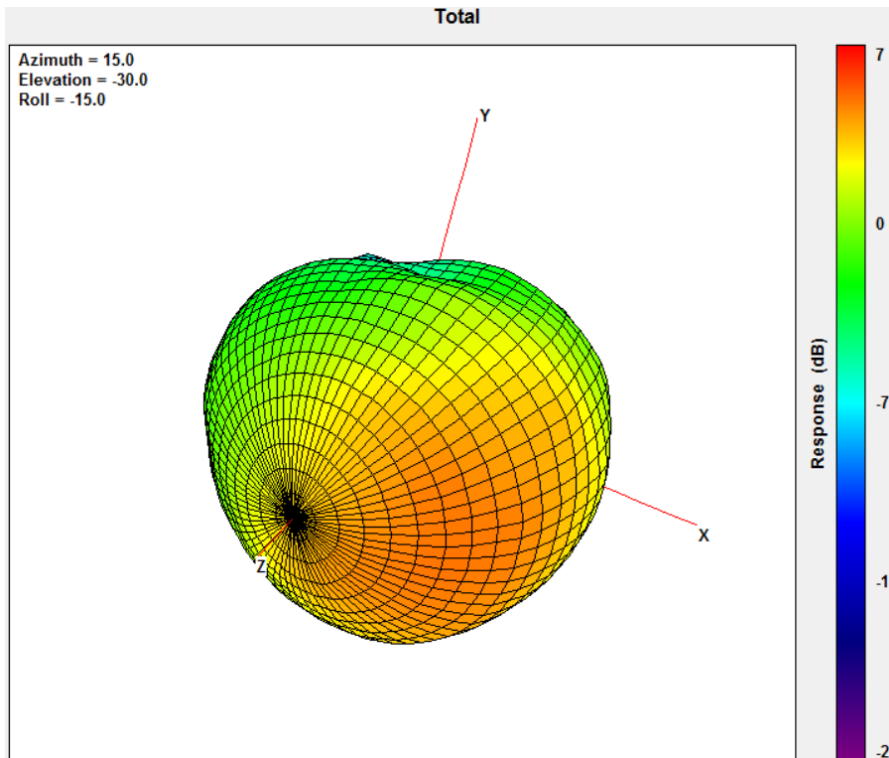

3.1.13 Axial Ratio Pattern

Frequency: 1575.42MHz

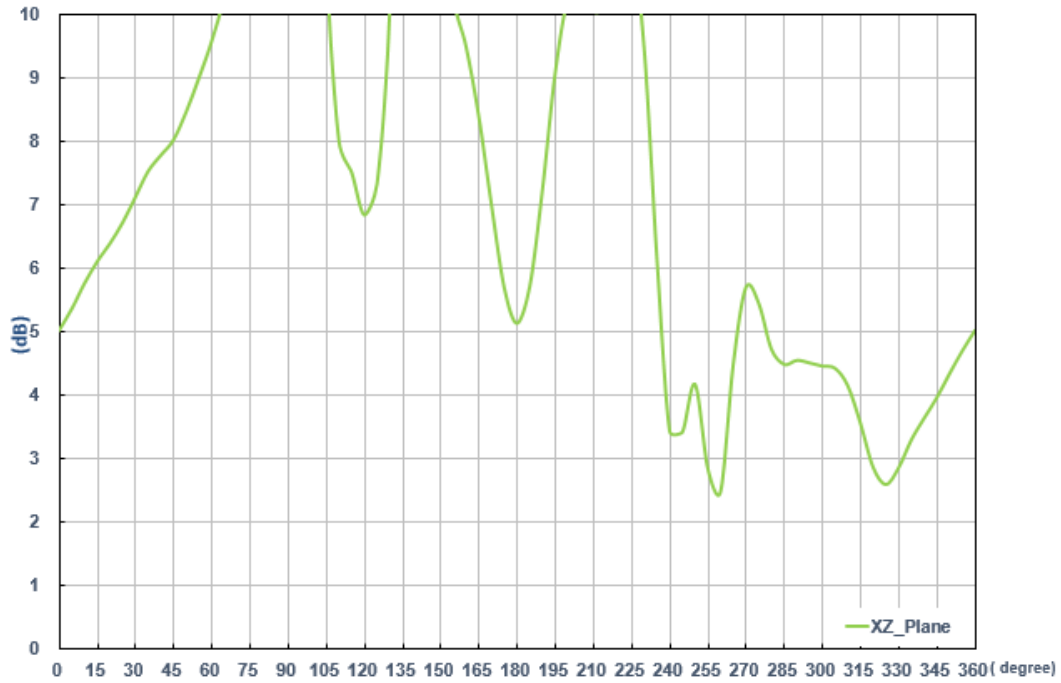

XZ Plane ($\phi=0^\circ$, $\Theta=-180\sim 180^\circ$)

Frequency: 1602MHz

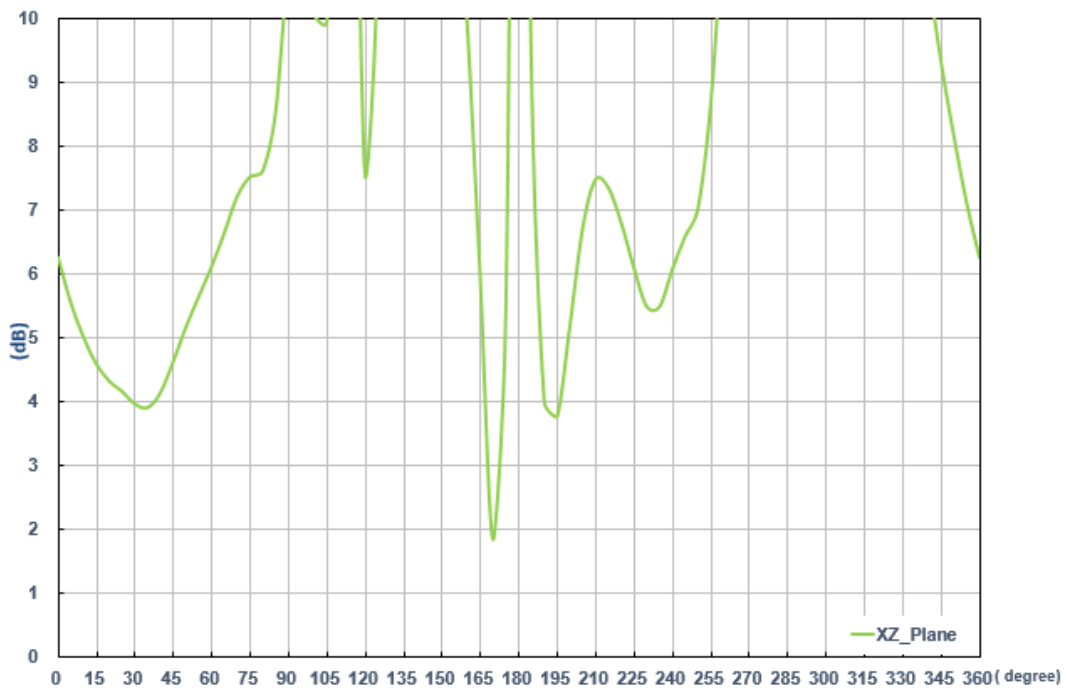

XZ Plane ($\phi=0^\circ$, $\Theta=-180\sim 180^\circ$)

3.2 Satellite L-Band 1621MHz Antenna

3.2.1 Test Setup



3.2.2 Satellite L-Band 1621MHz Return Loss

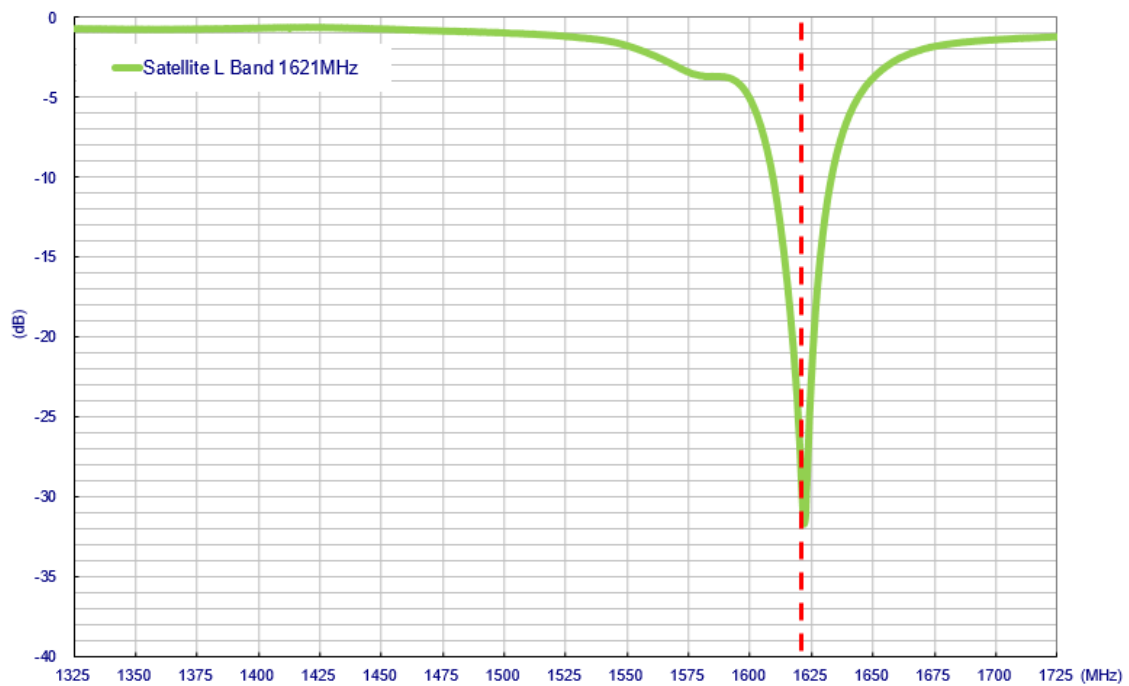

3.2.3 Satellite L-Band 1621MHz Smith Chart

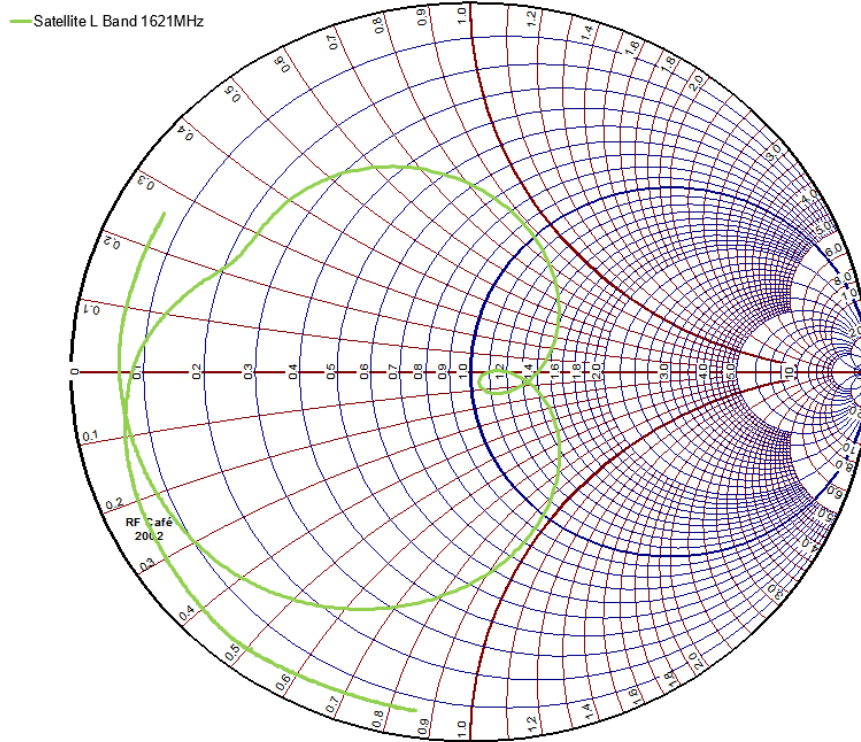

3.2.4 Satellite L-Band 1621MHz VSWR

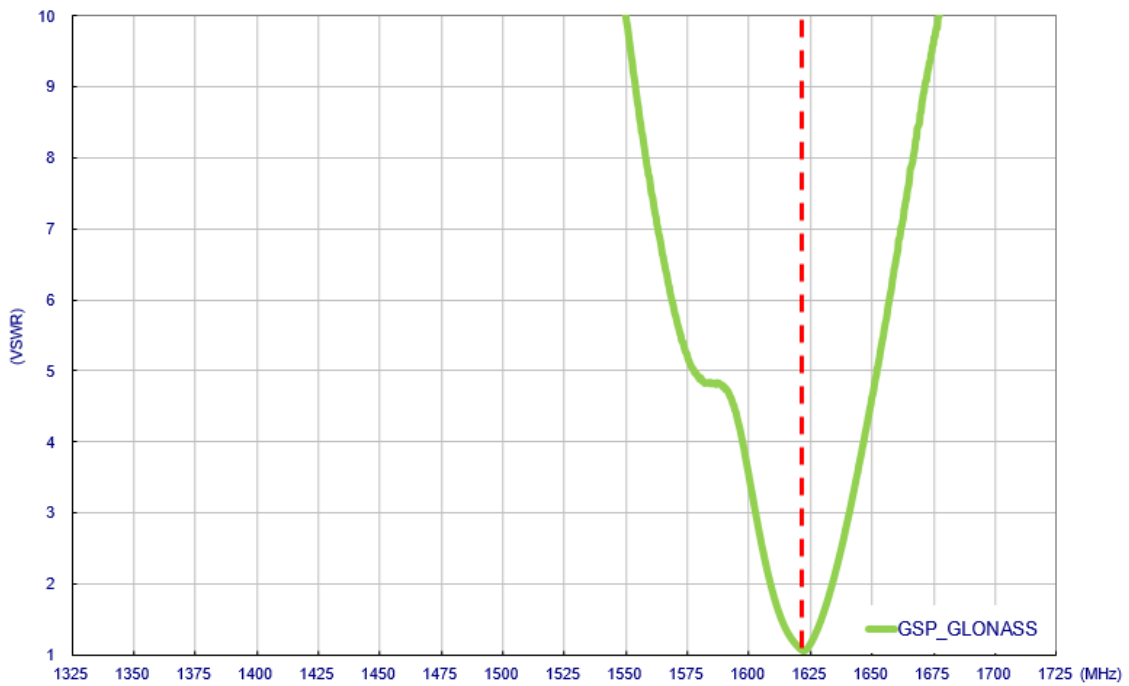

3.2.5 Satellite L-Band 1621MHz Efficiency

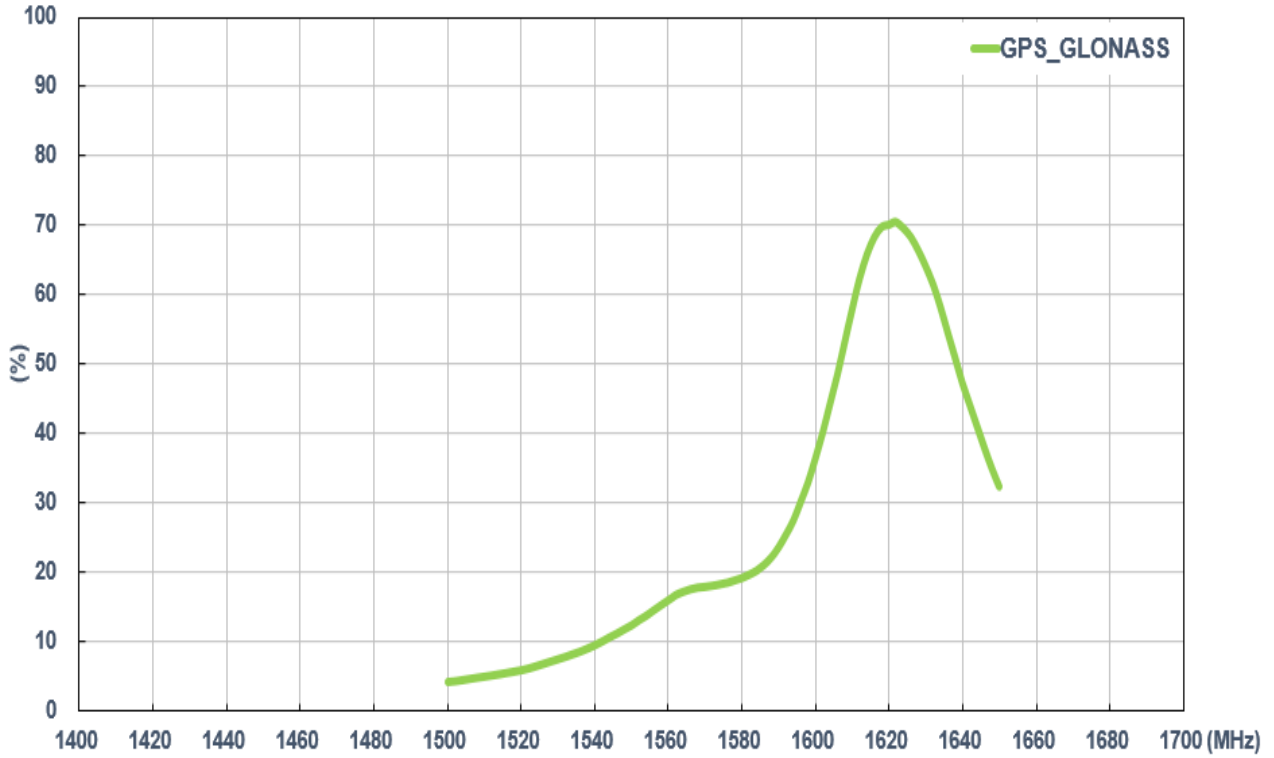

3.2.6 Satellite L-Band 1621MHz Average gain

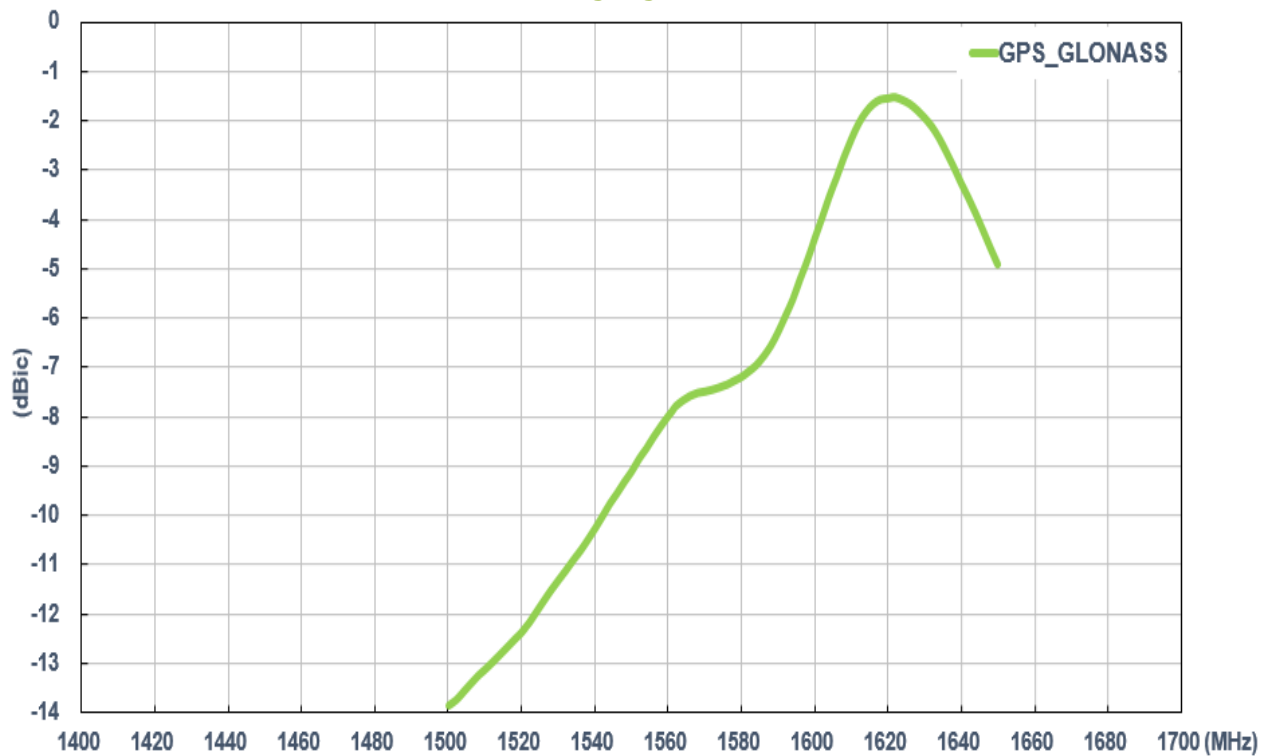

3.2.7 Satellite L-Band 1621MHz Peak gain

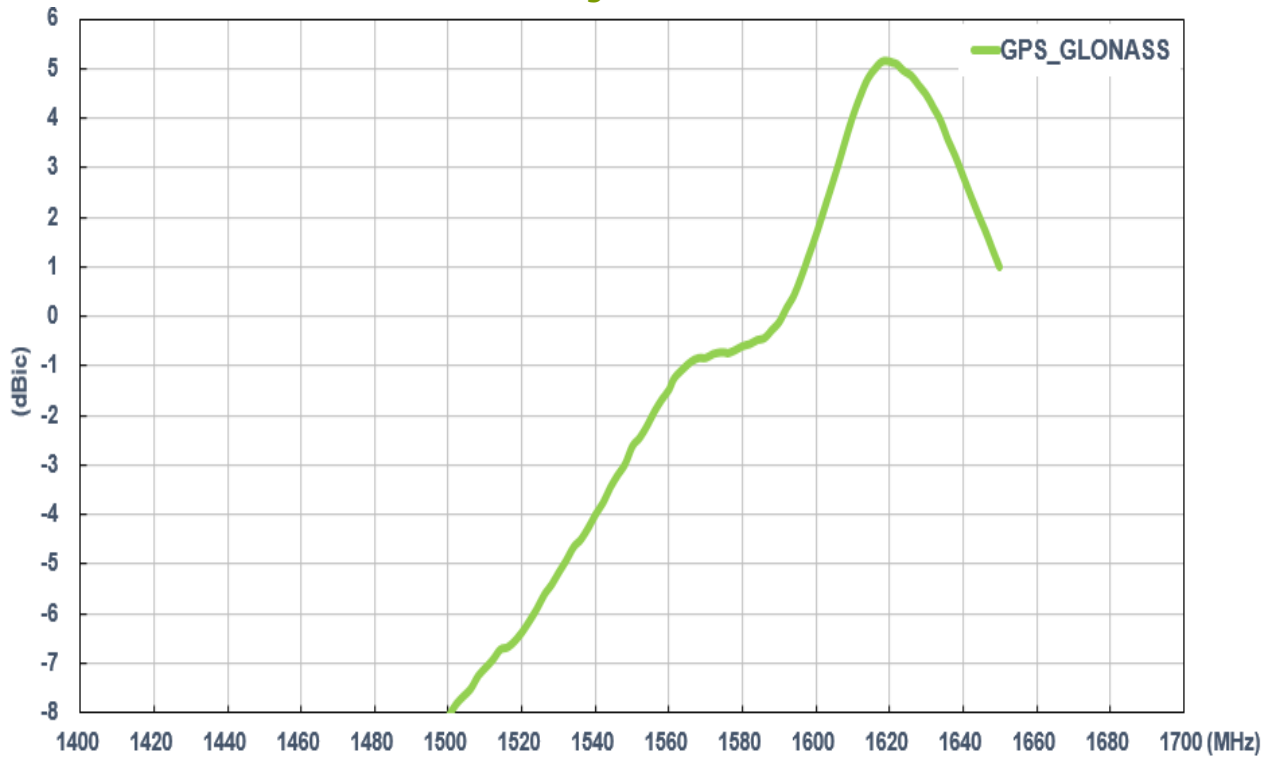

3.2.8 Test Setup For Antenna Radiation Pattern

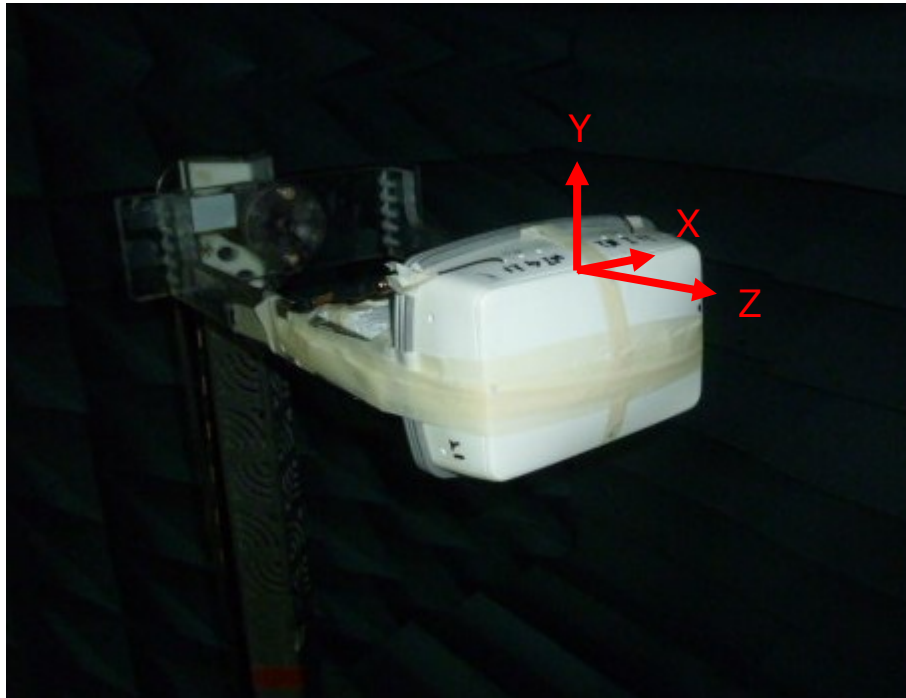

In free space

3.2.9 Satellite L-Band 1621MHz 2D Radiation Pattern

2D Radiation pattern @ 1621MHz

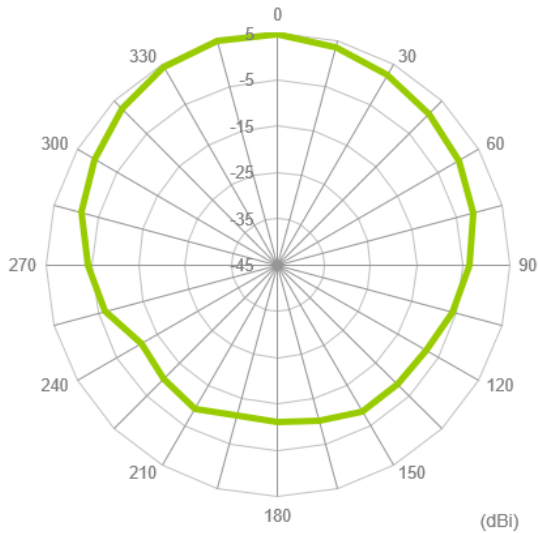

XZ Plane ($\phi=0^\circ$, $\Theta=0\sim 360^\circ$)

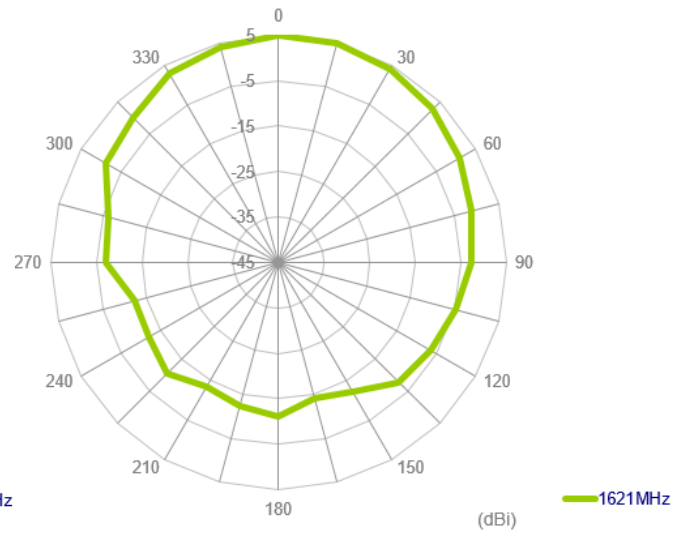

YZ Plane ($\phi=90^\circ$, $\Theta=0\sim 360^\circ$)

3.2.10 Satellite L-Band 1621MHz 3D Radiation Pattern

3D Radiation pattern @ 1621MHz

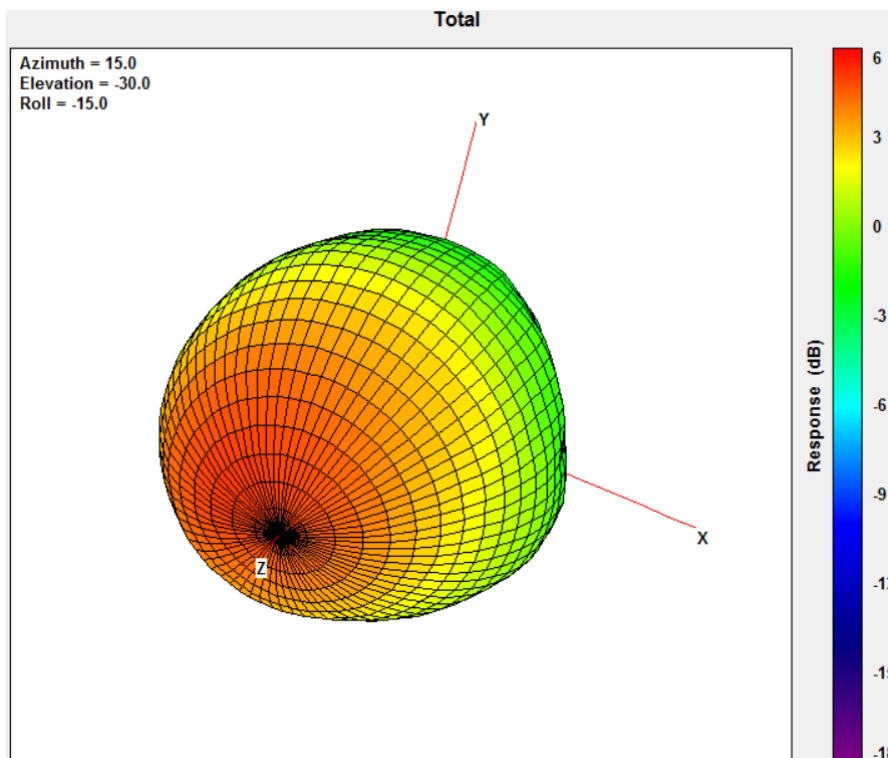

3.2.11 Axial Ratio Pattern

Frequency: 1621MHz

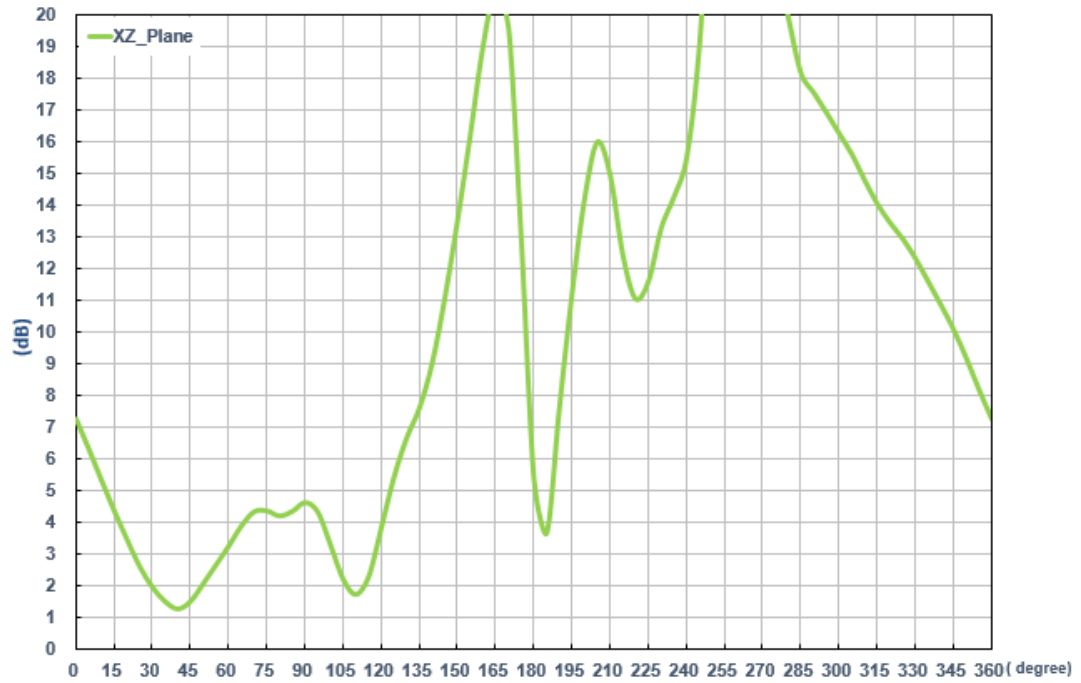

XZ Plane (phi=0° , Theta=-180~180°)

3.3 LTE_MIMO/Wi-Fi_MIMO Antenna

3.3.1 Test Setup



In free space

3.3.2 LTE MIMO Antenna S-parameters

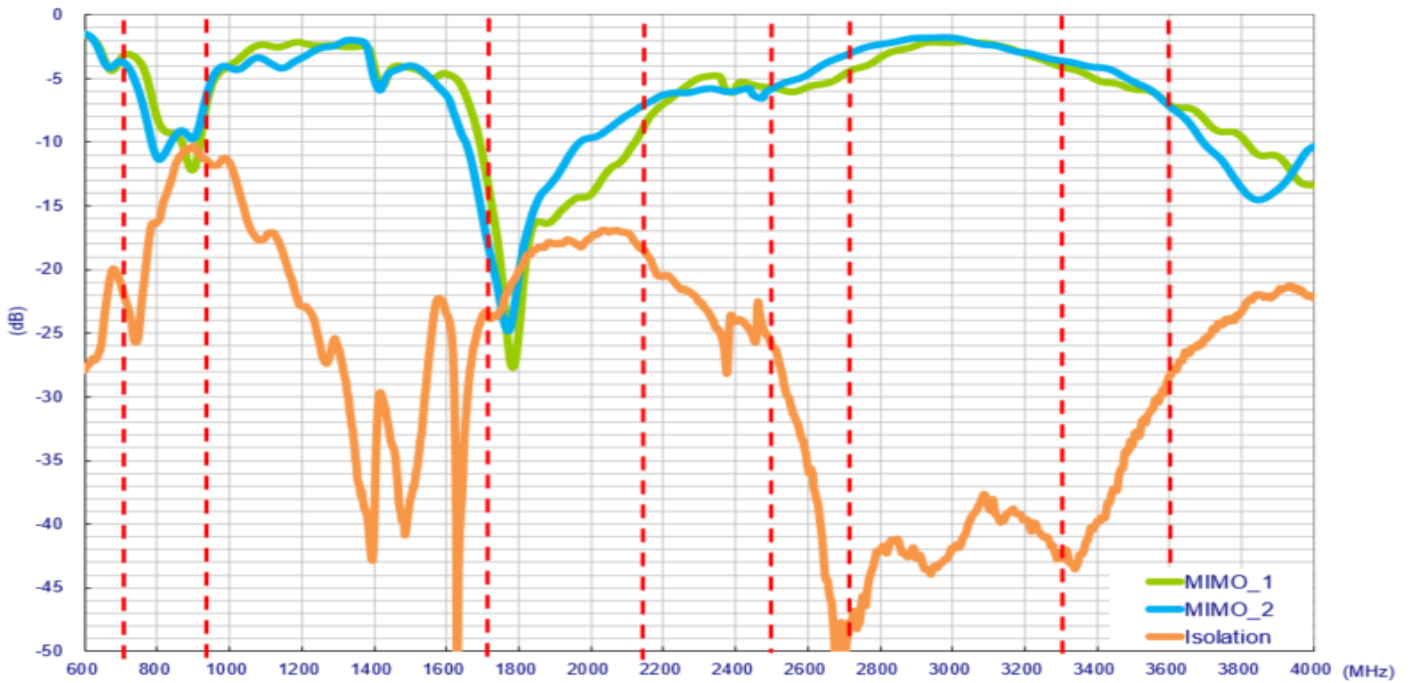

3.3.3 Envelope Correlation Coefficient (LTE)

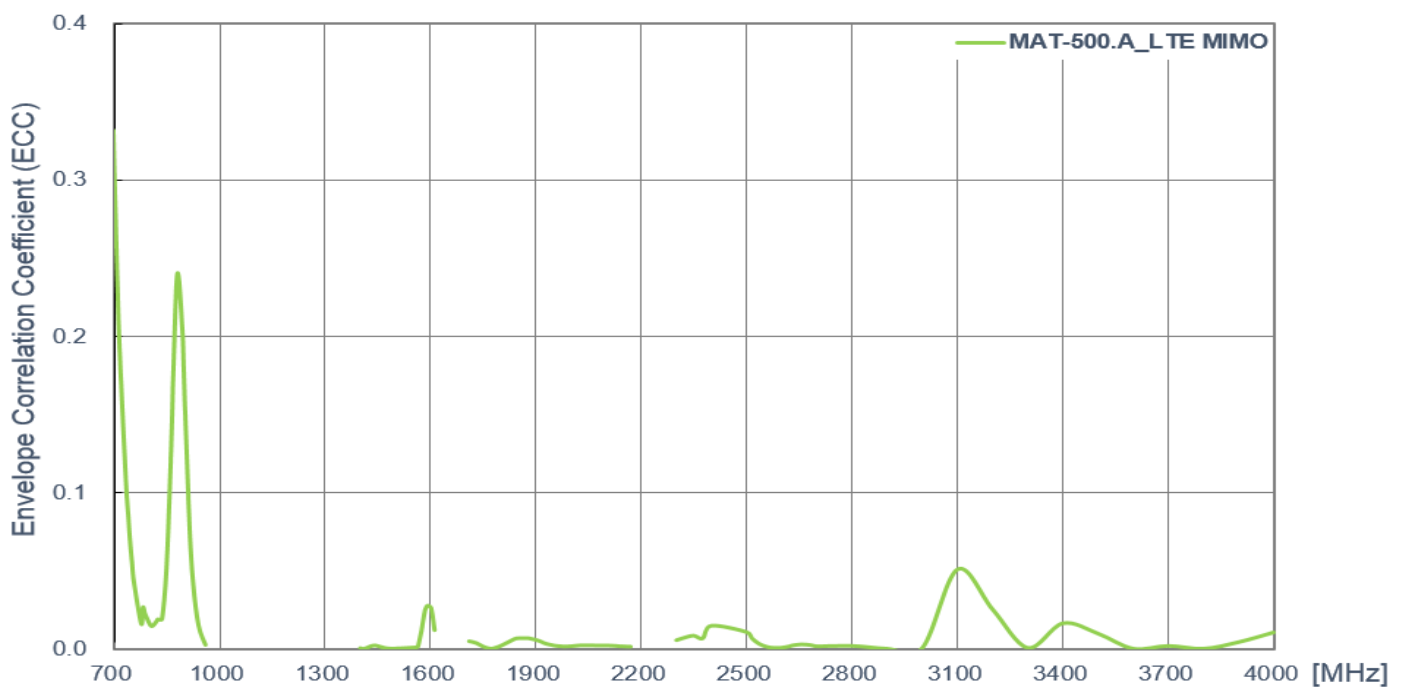

3.3.4 LTE Antenna Efficiency

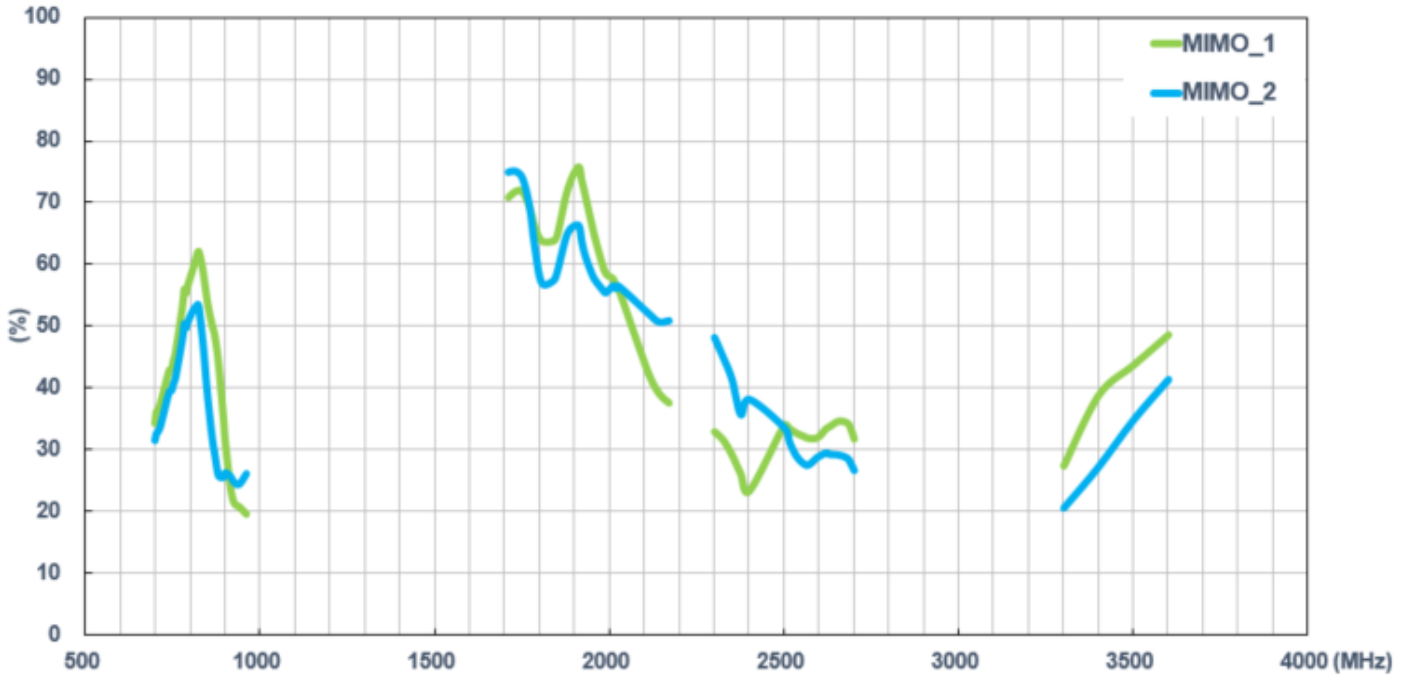

3.3.5 LTE Antenna Peak Gain

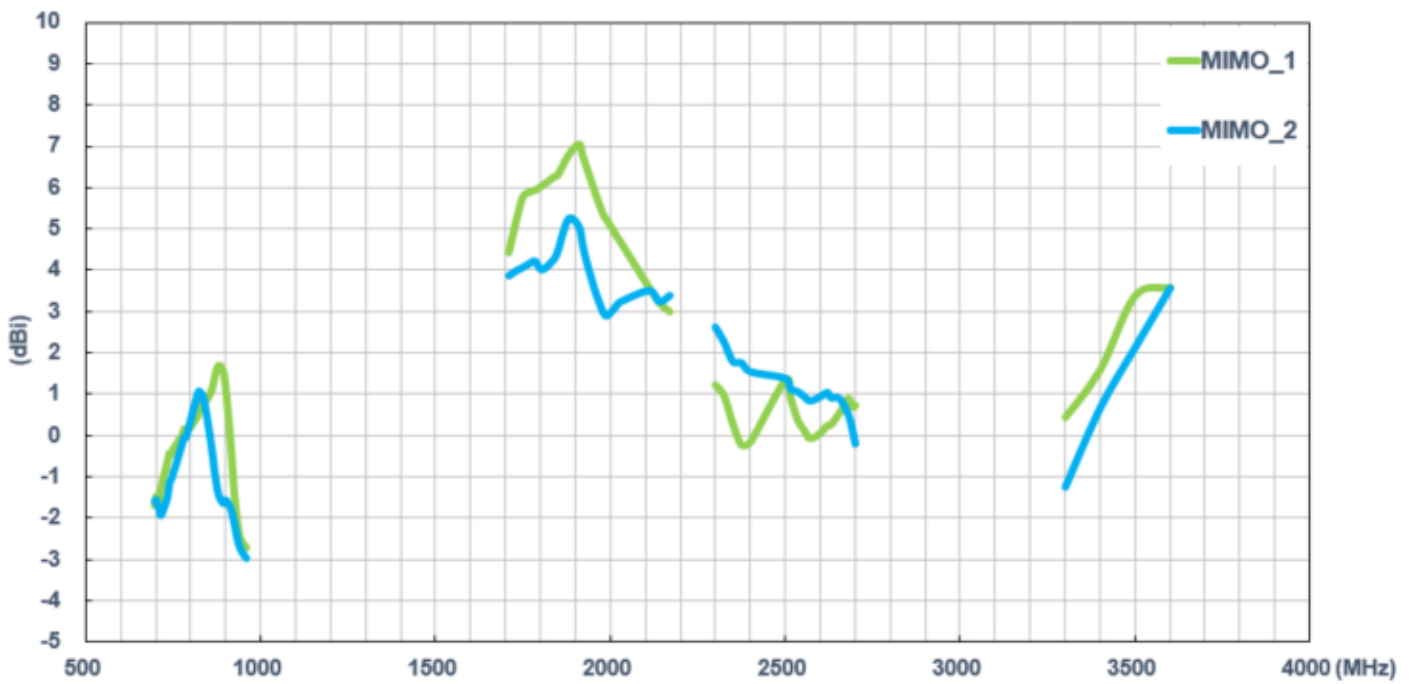

3.3.6 LTE Antenna Peak Gain

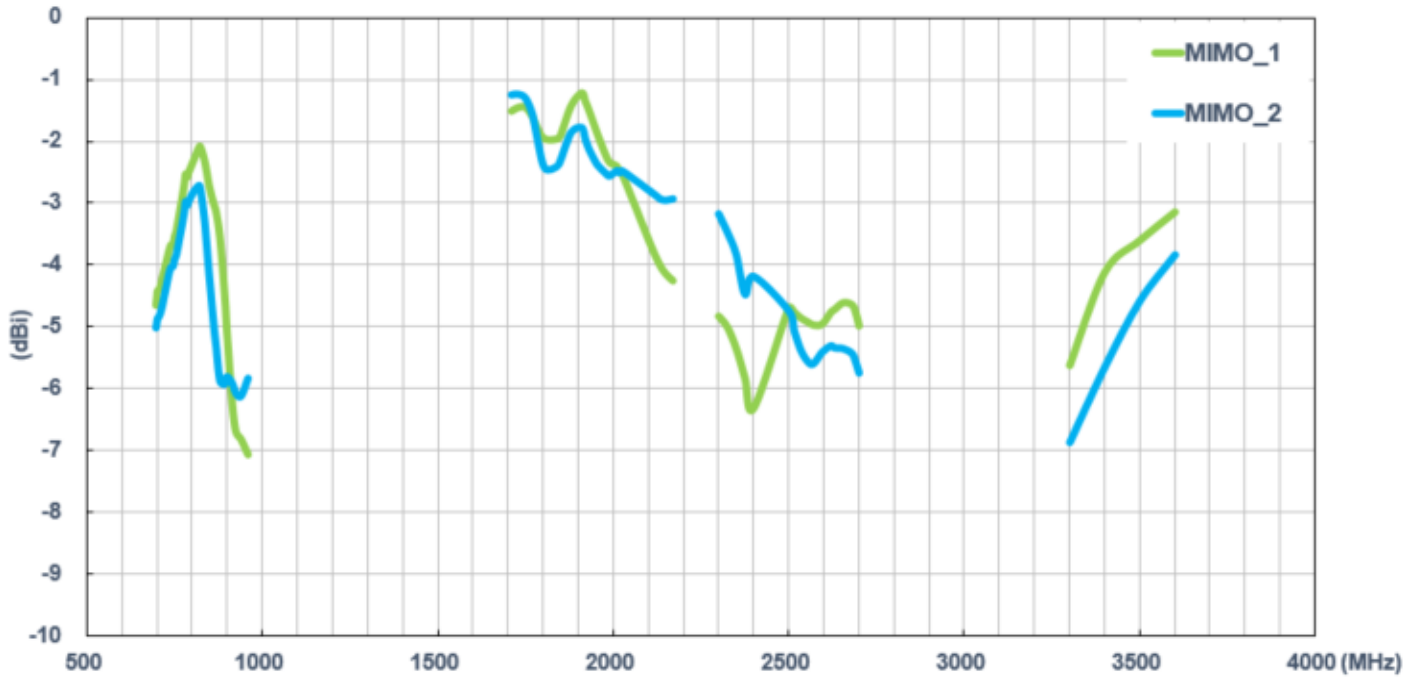

3.3.7 Wi-Fi Antenna Return Loss

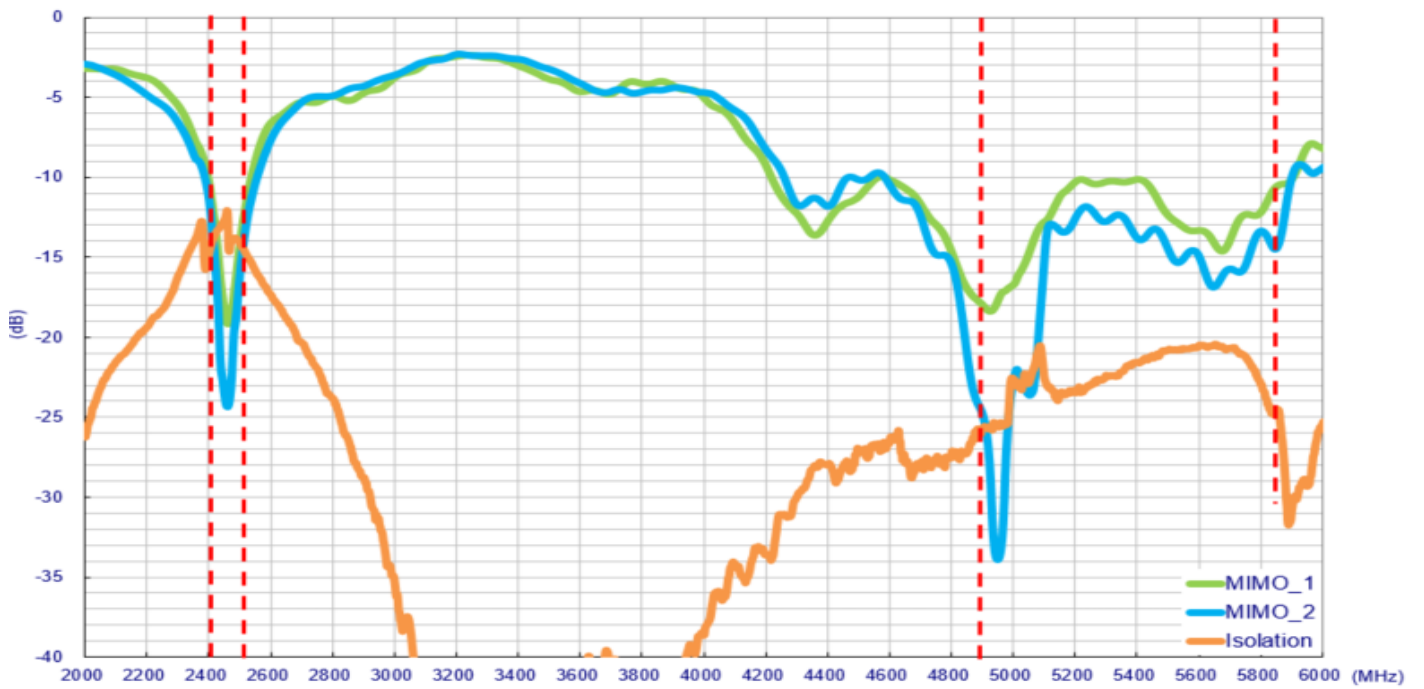

3.3.8 Envelope Correlation Coefficient

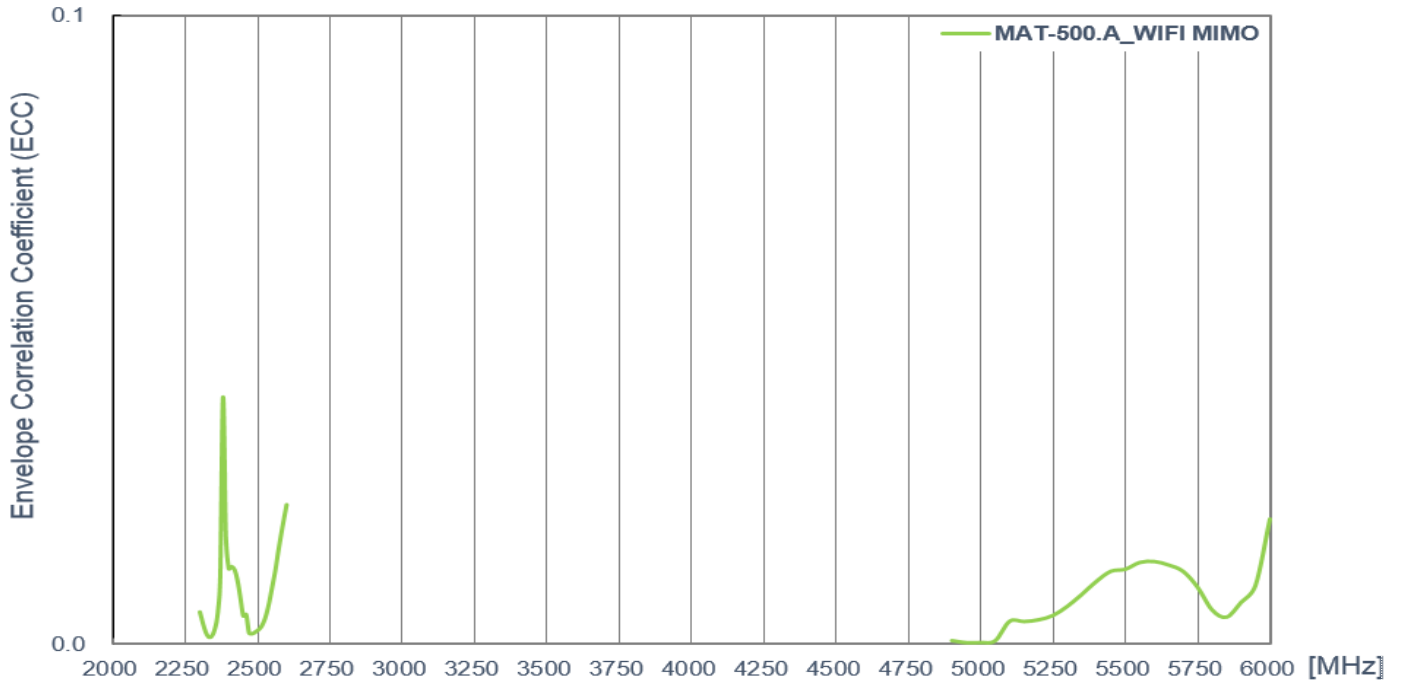

3.3.9 Wi-Fi Antenna Efficiency

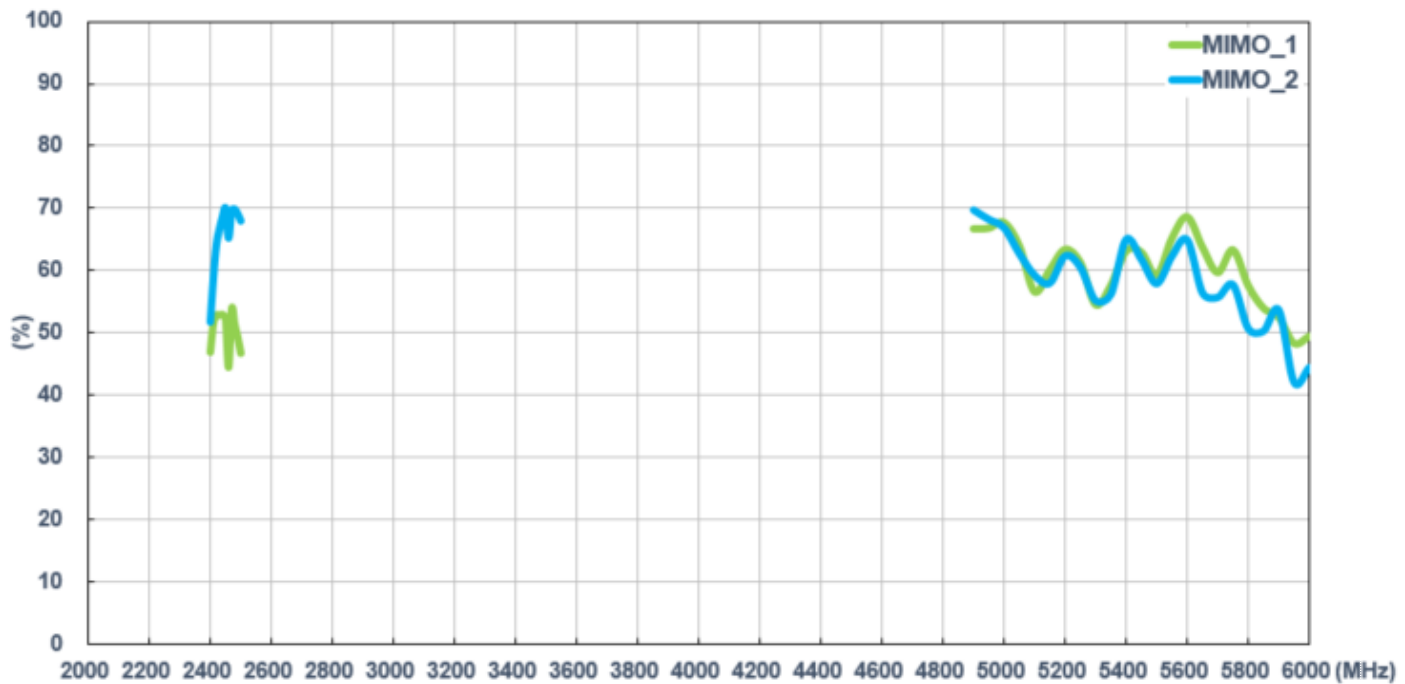

3.3.10 Wi-Fi Antenna Peak Gain

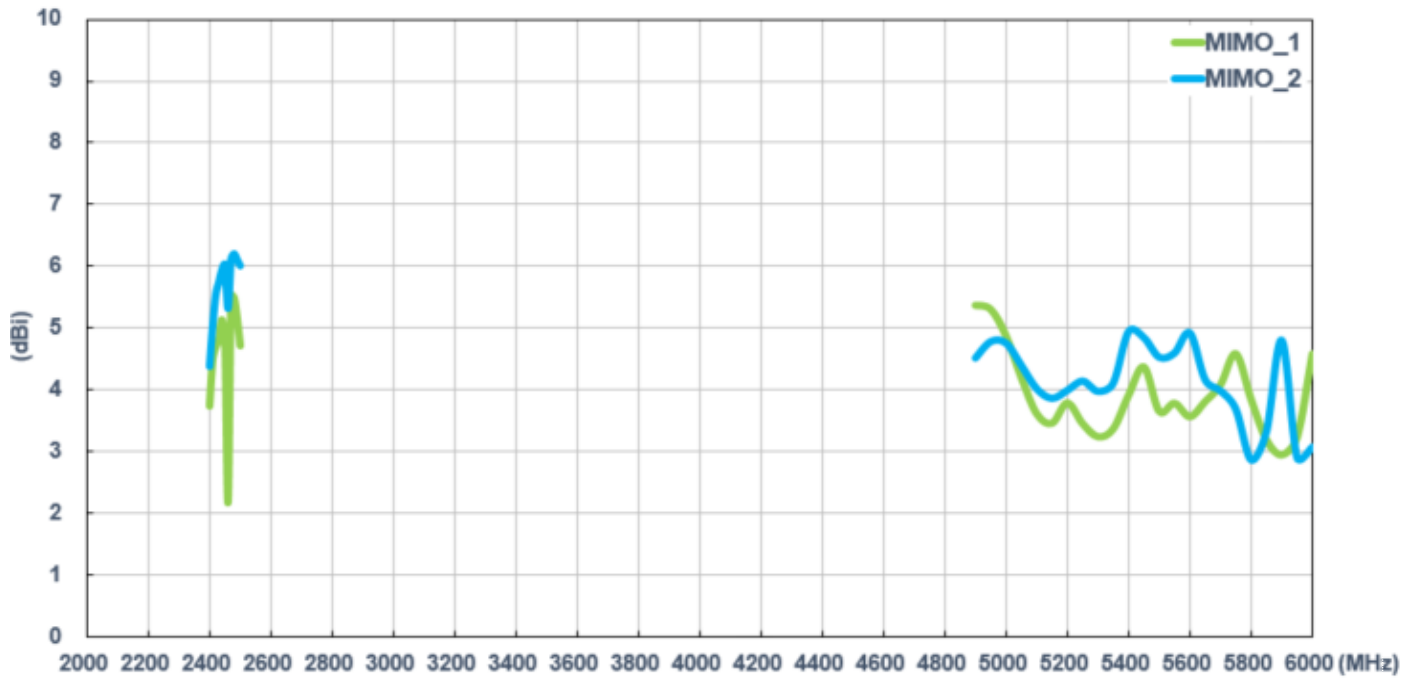

3.3.11 Wi-Fi Antenna Average Gain

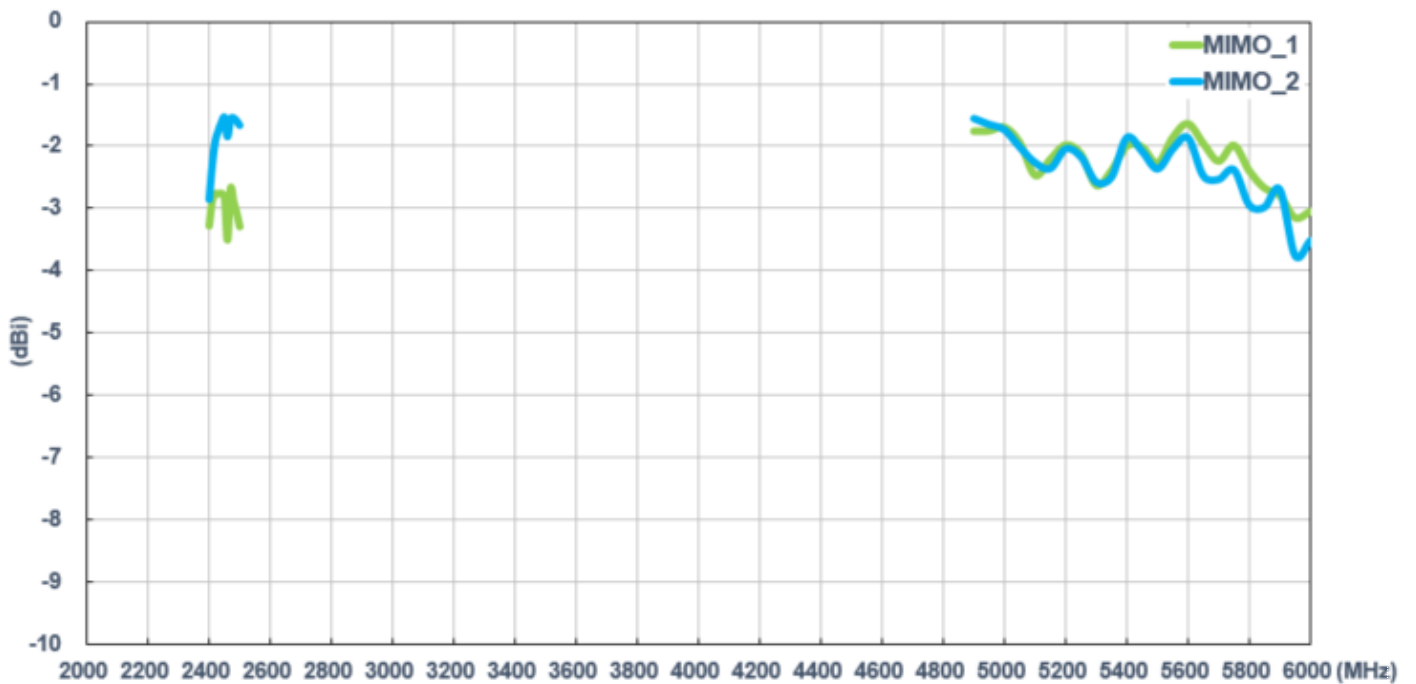

3.3.12 Test Setup For Antenna Radiation Pattern (ETS Anechoic chamber)

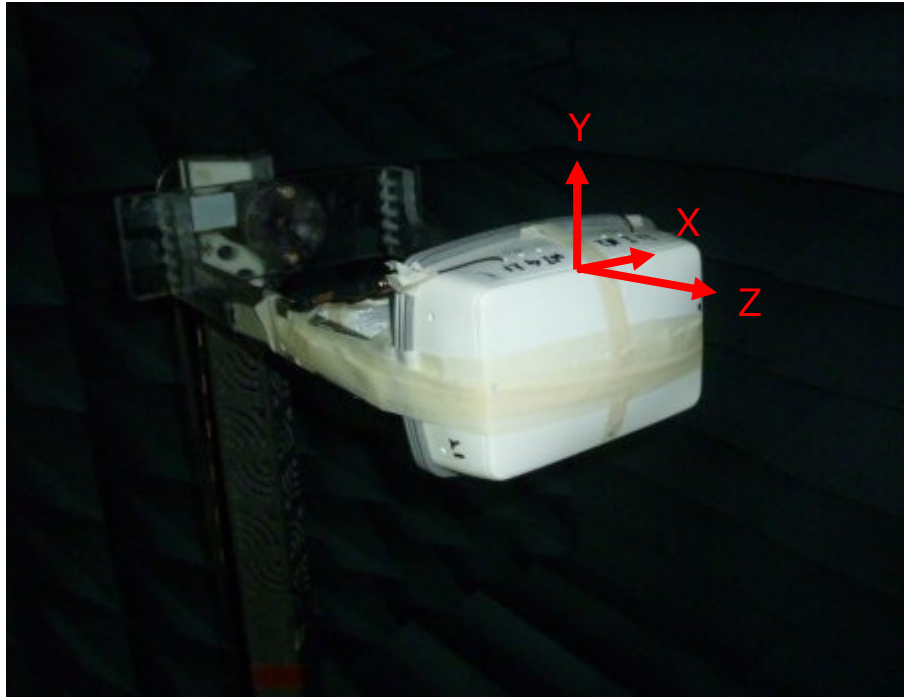

In free space

3.3.13 2D Radiation Pattern (LTE_MIMO1)

XY Plane

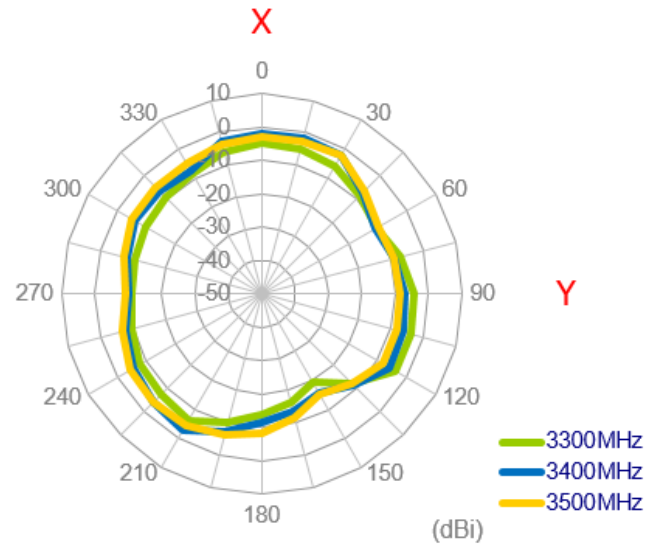
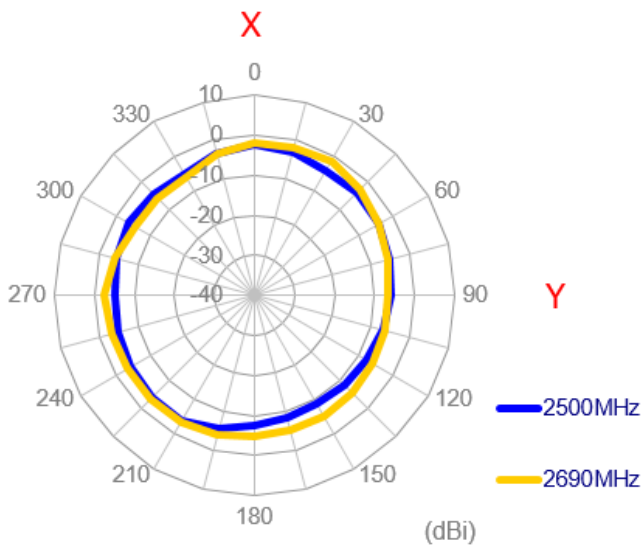
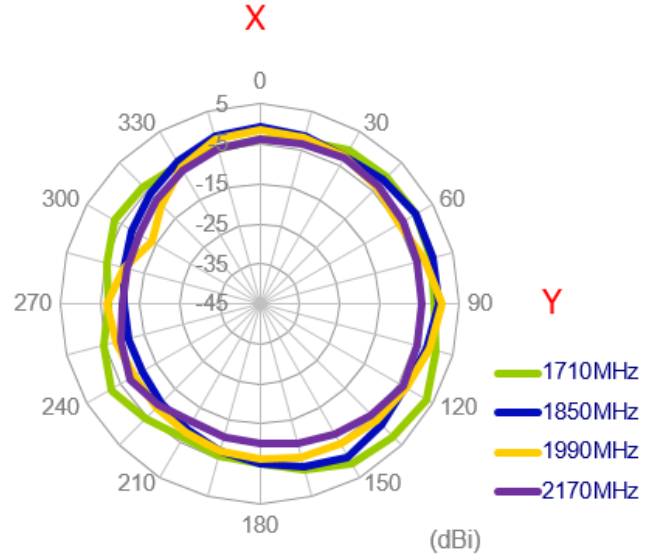
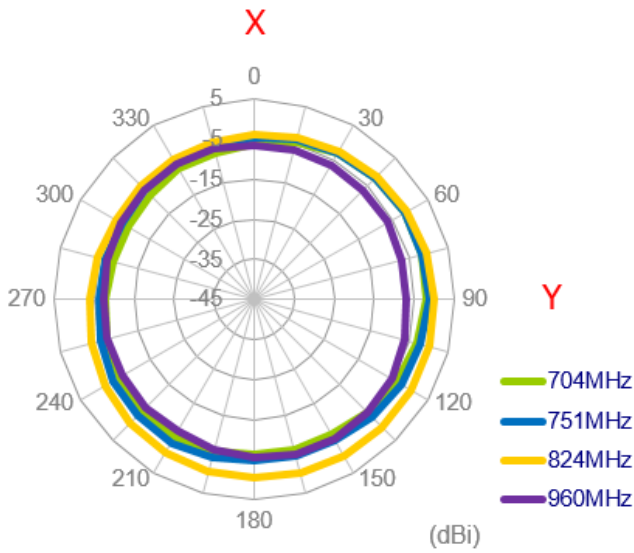

XZ Plane

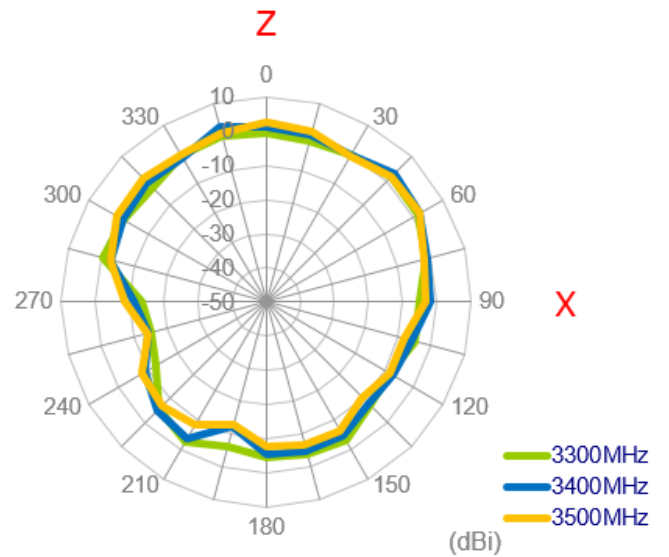
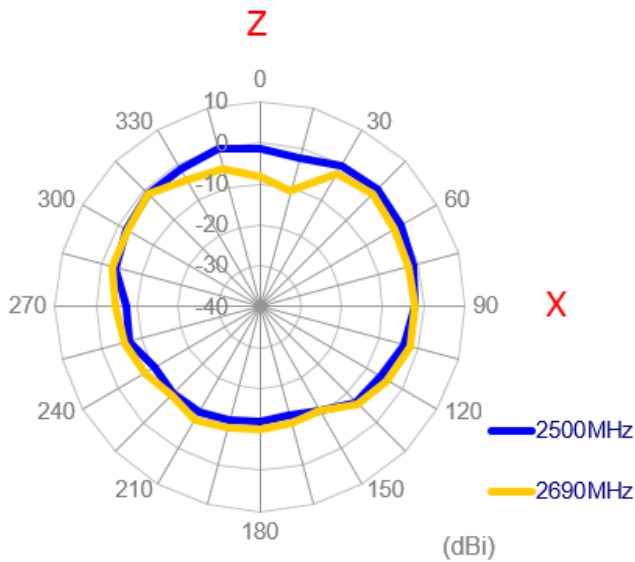
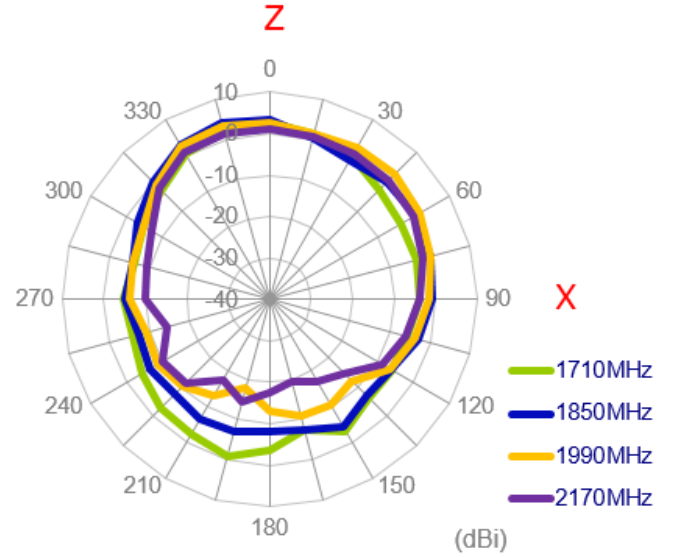
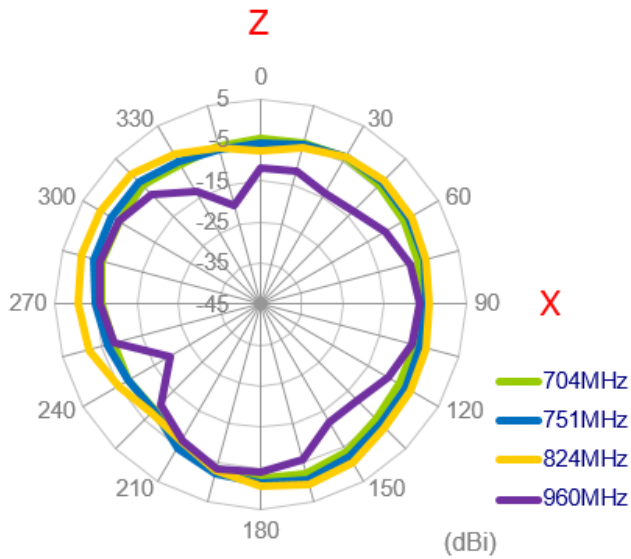

YZ Plane

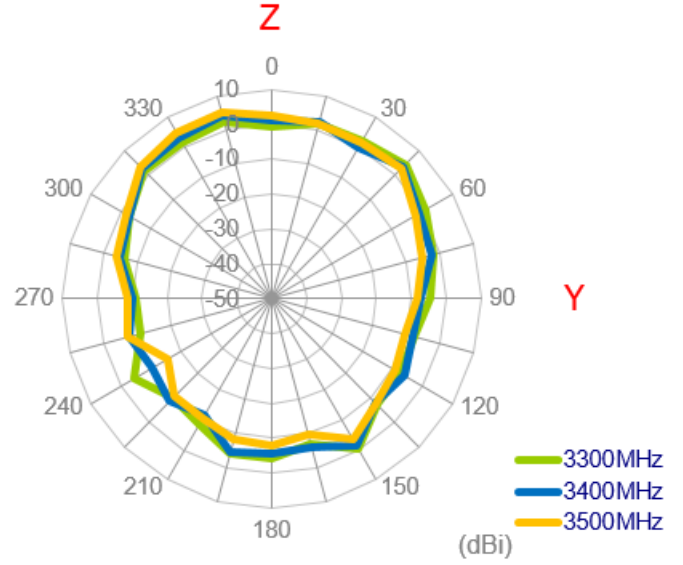
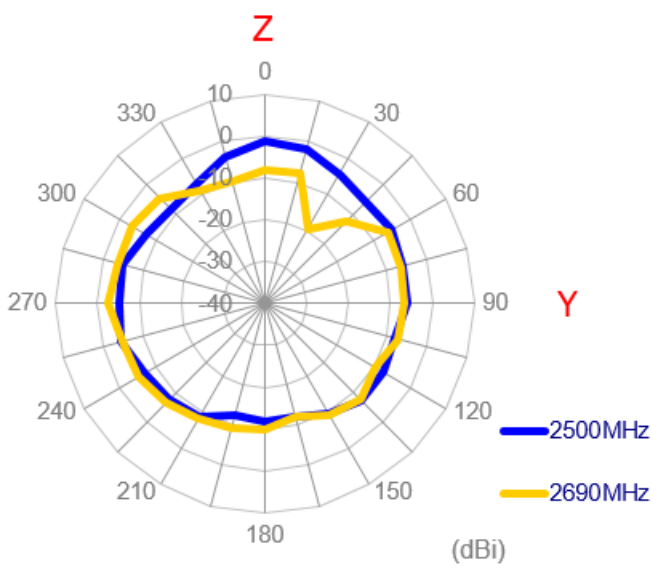
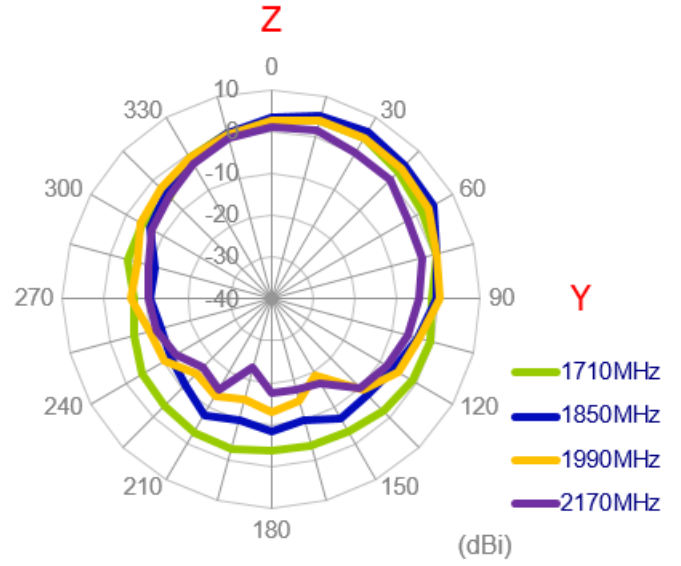
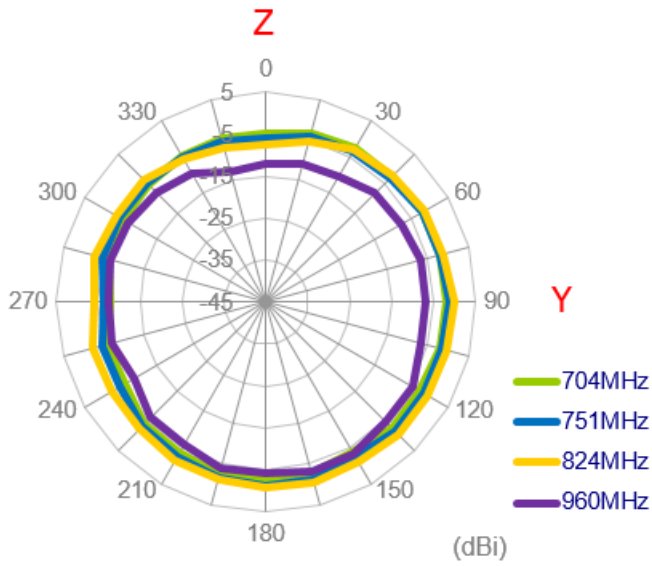

3.3.14 3D Radiation Pattern (LTE_MIMO1)

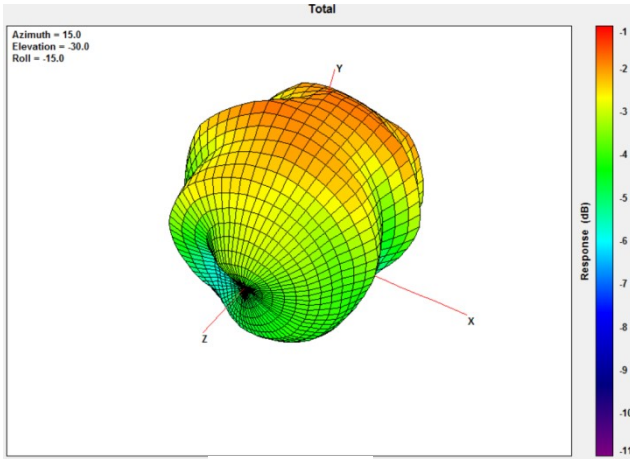

704MHz

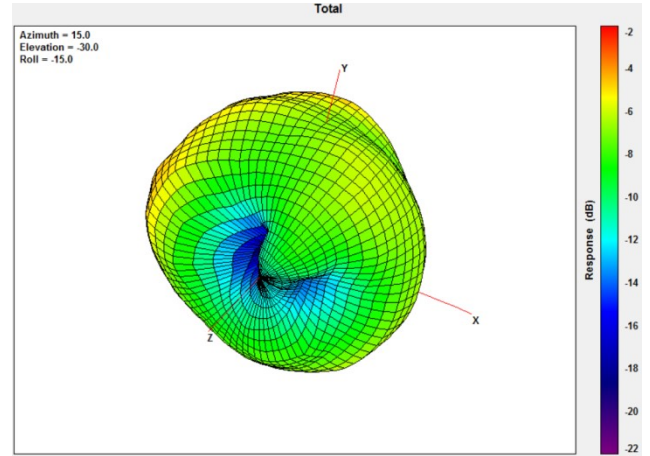

960MHz

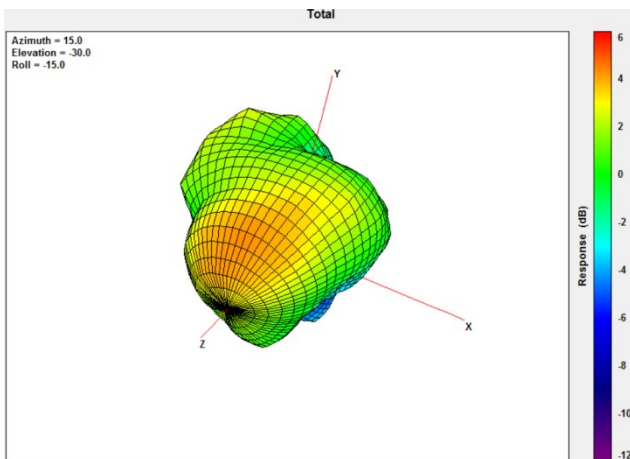

1710MHz

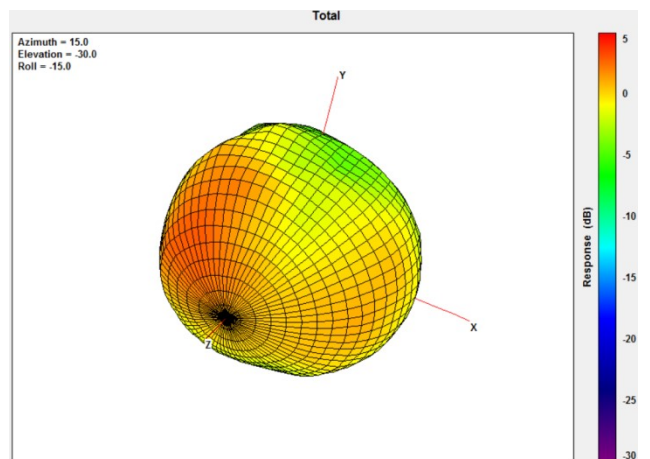

2170MHz

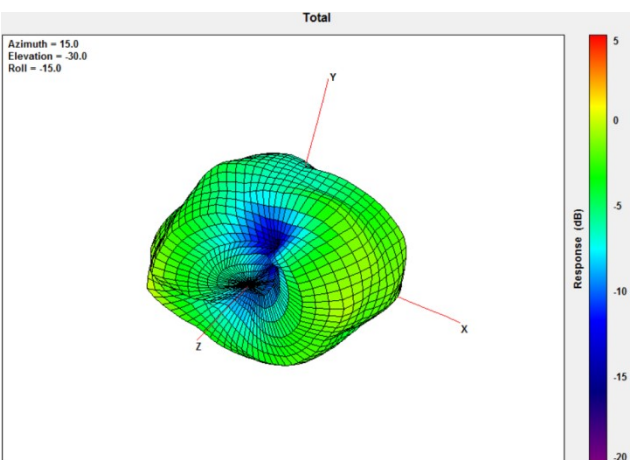

2690MHz

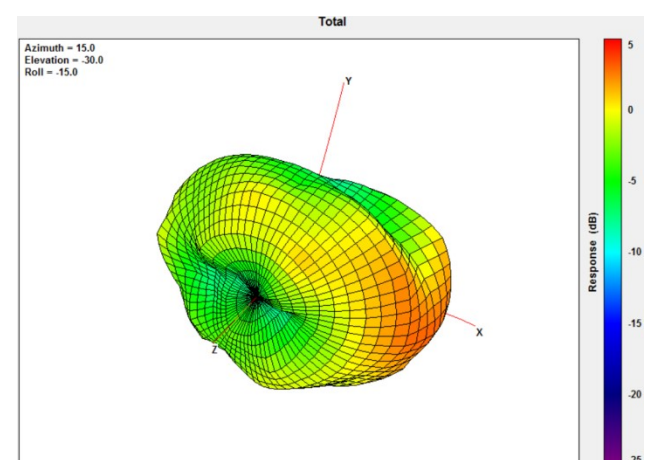

3500MHz

3.3.15 2D Radiation Pattern (LTE_MIMO2)

XY Plane

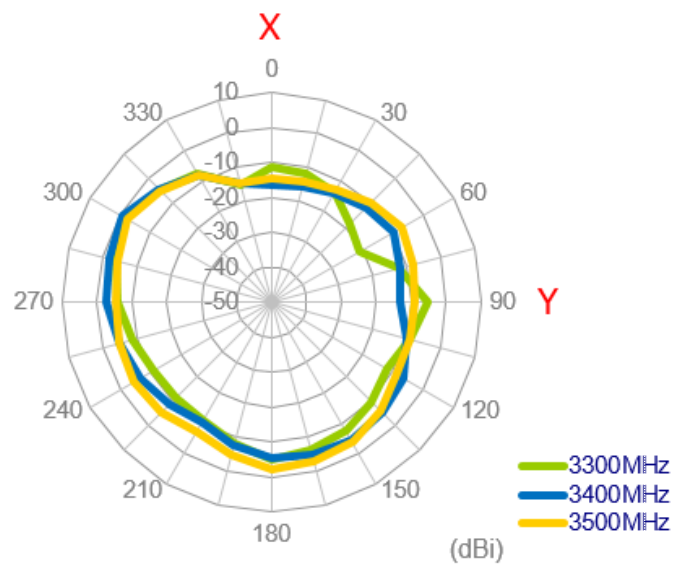
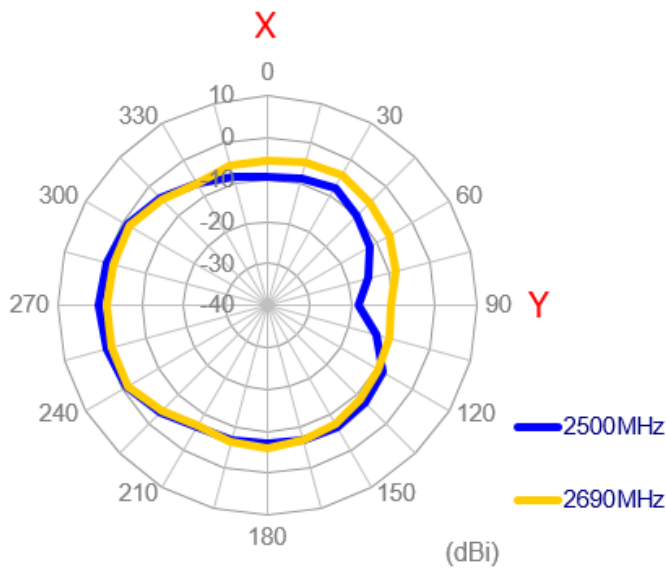
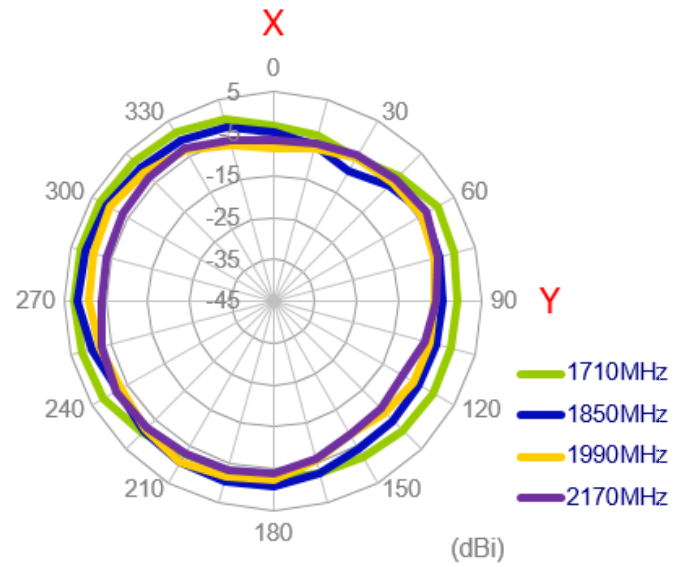
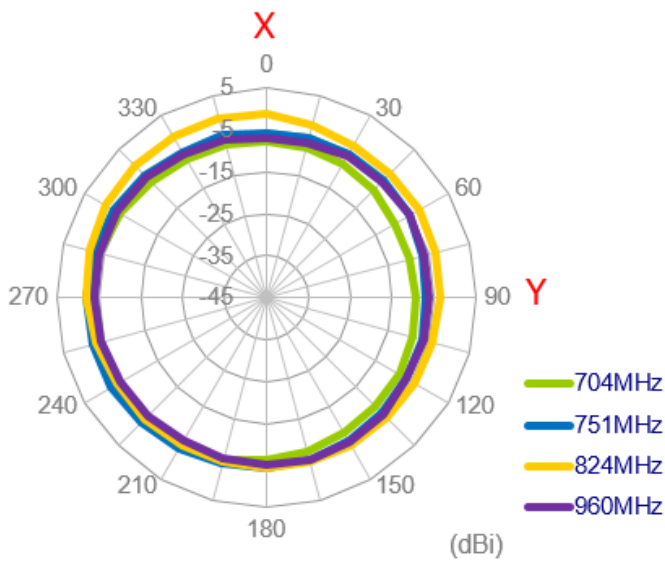

XZ Plane

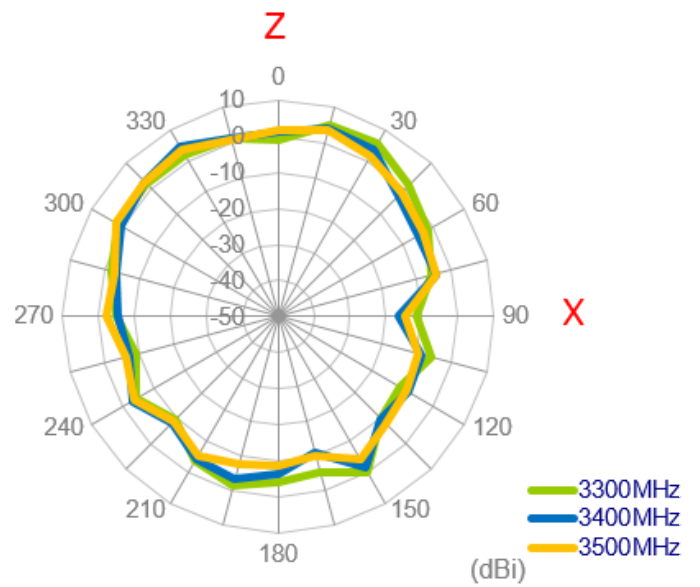
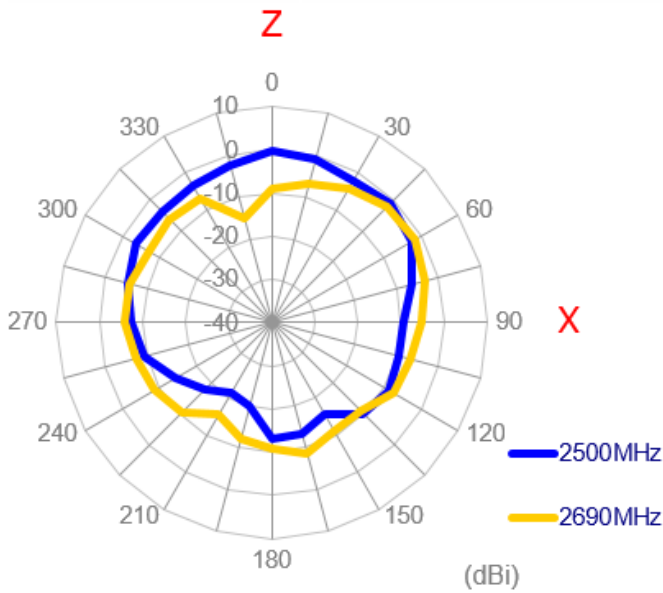
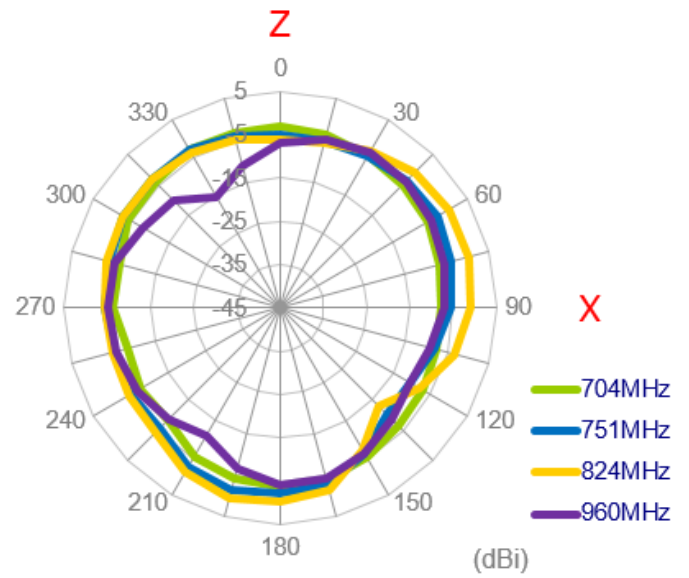
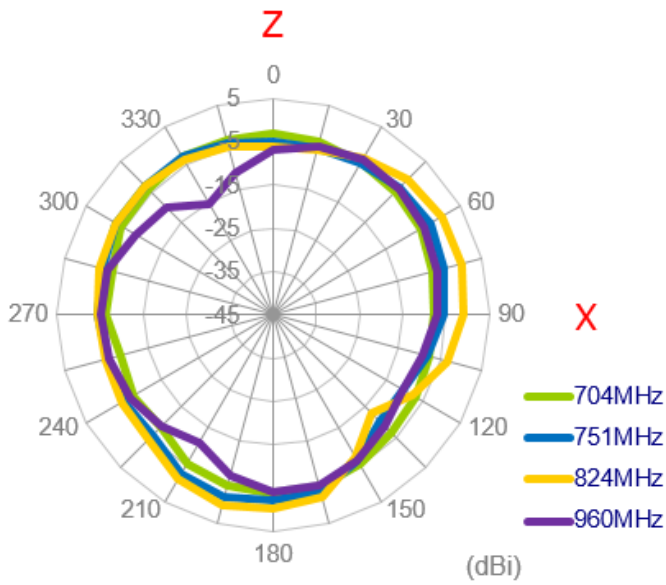

YZ Plane

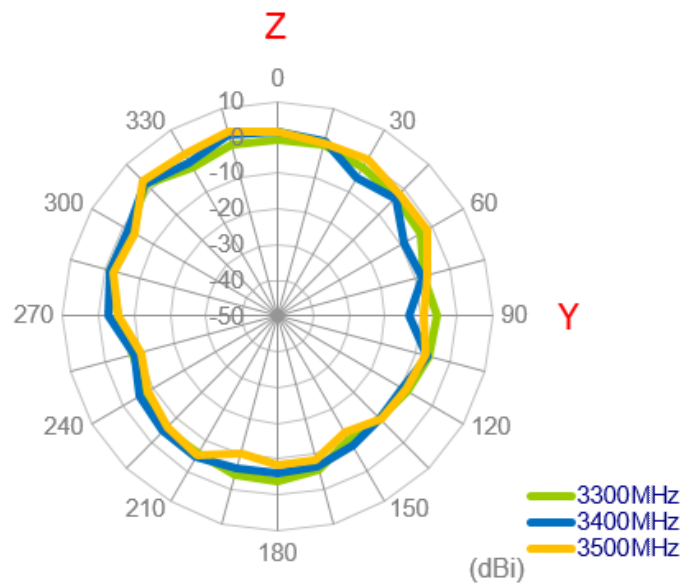
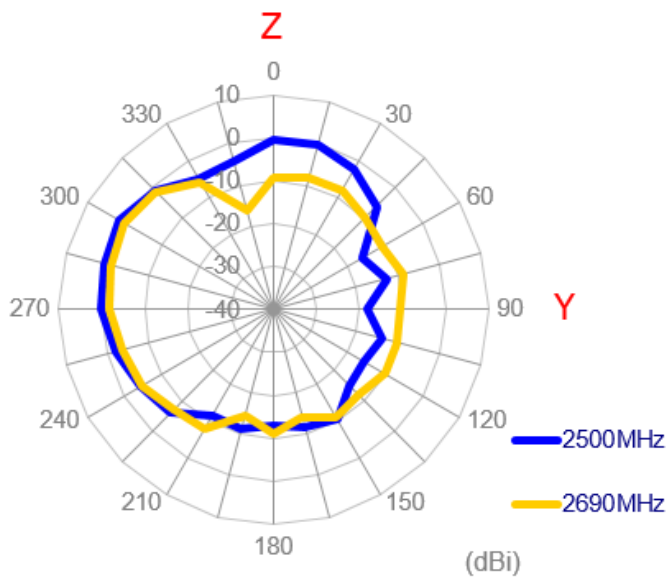
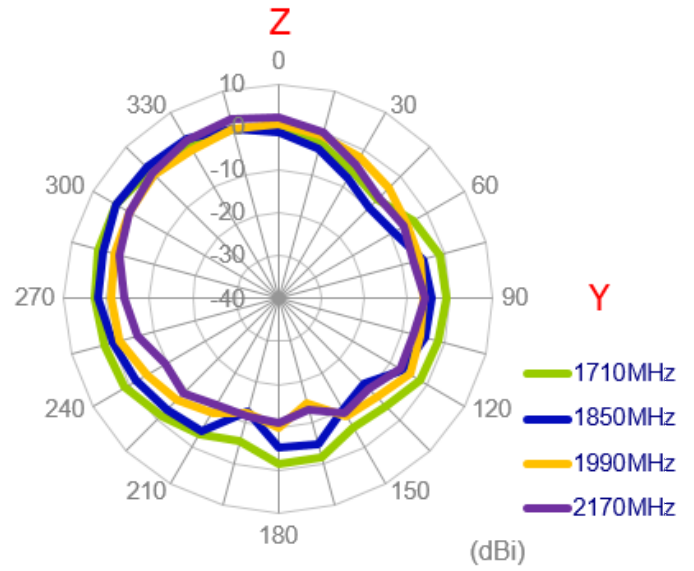
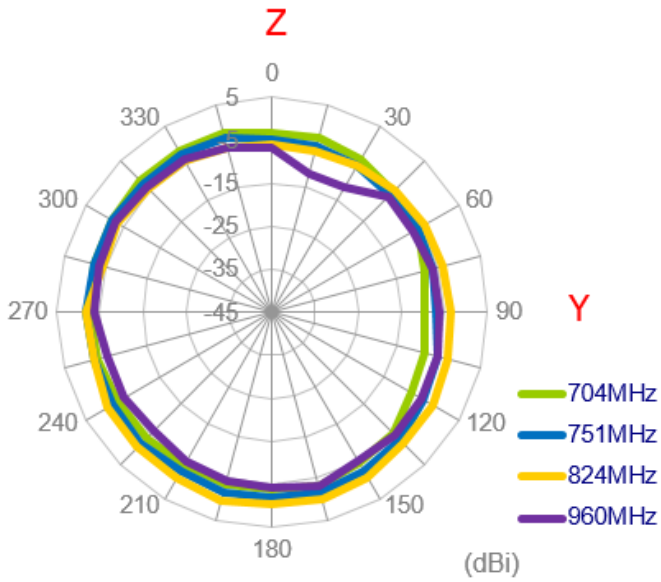

3.3.16 3D Radiation Pattern (LTE_MIMO2)

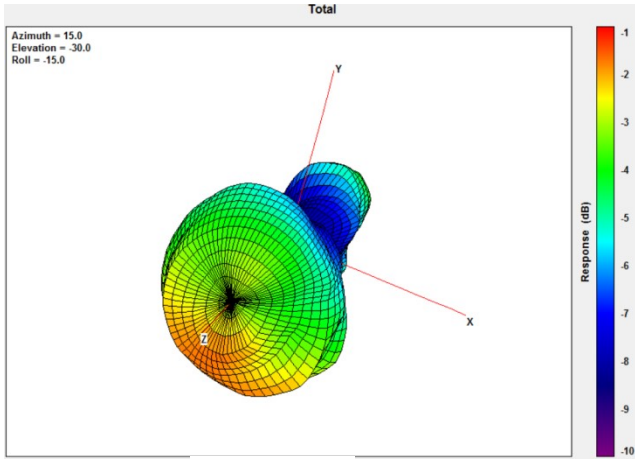

704MHz

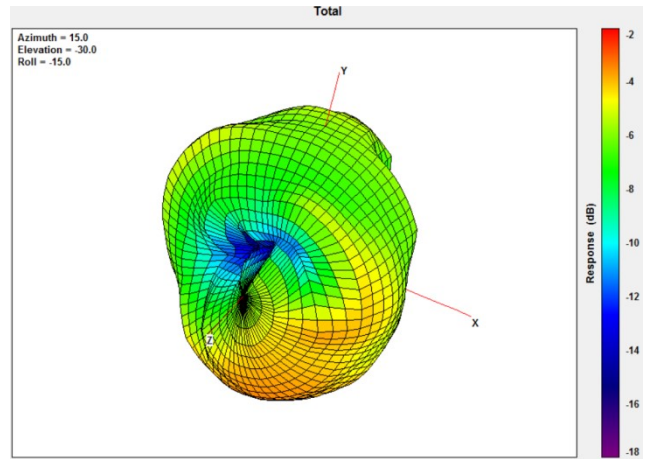

960MHz

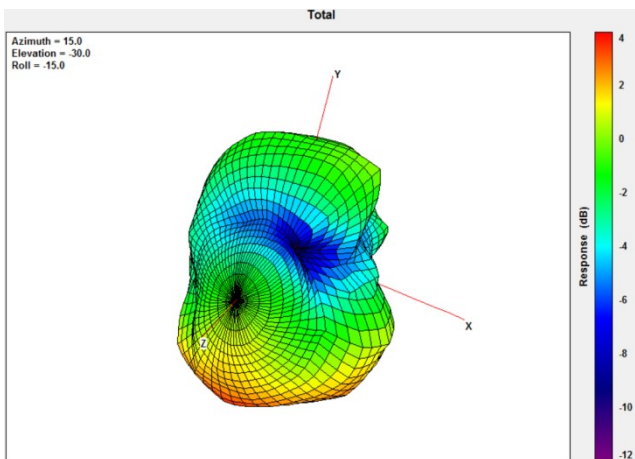

1710MHz

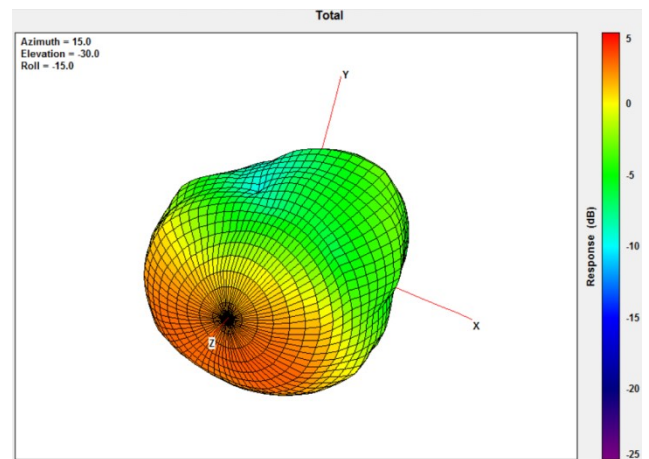

2170MHz

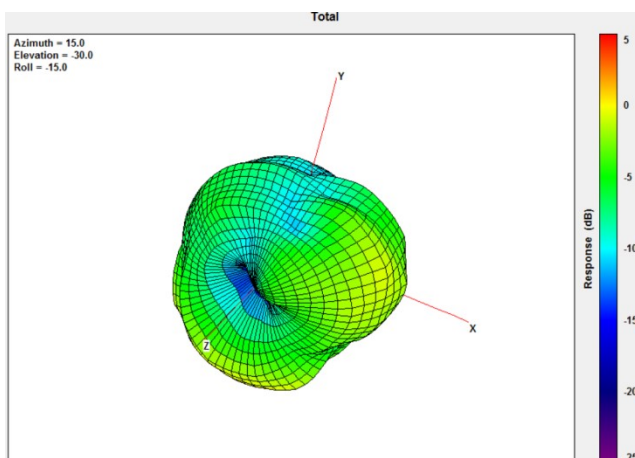

2690MHz

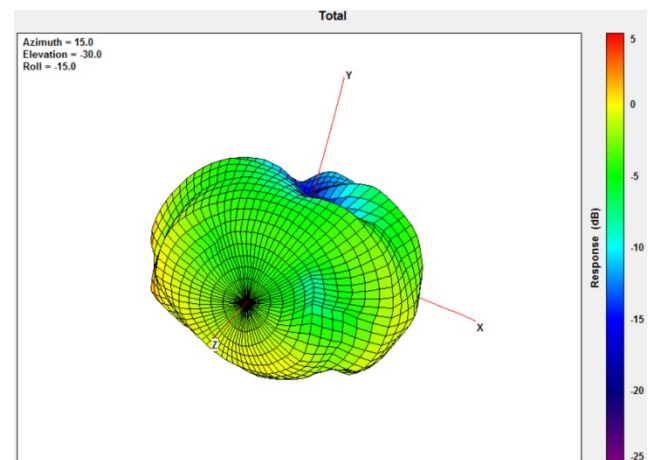

3500MHz

3.3.17 2D Radiation Pattern (Wi-Fi_MIMO1)

XY Plane

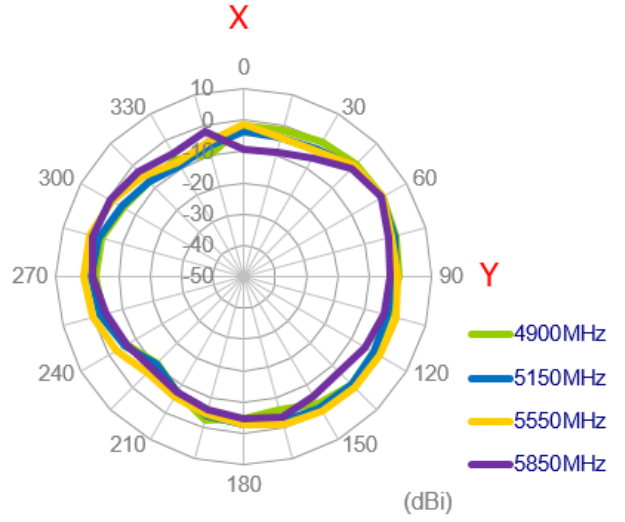
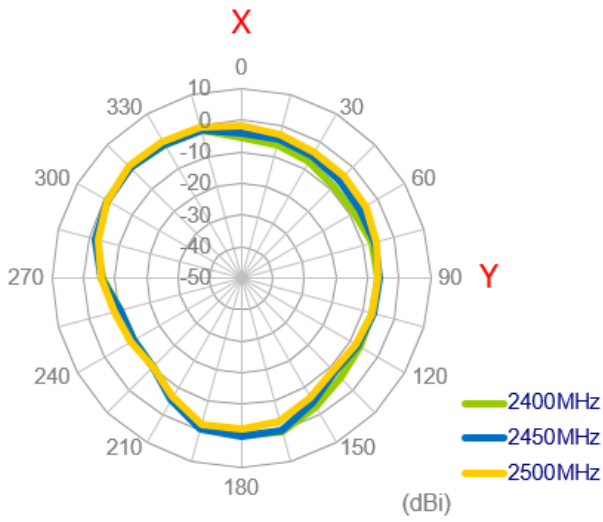

XZ Plane

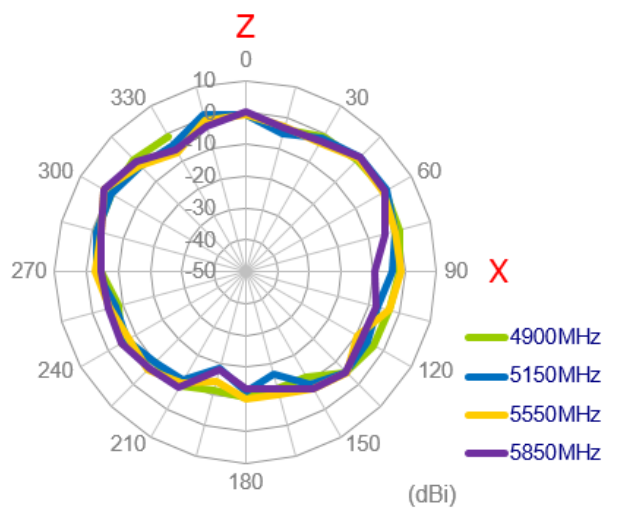
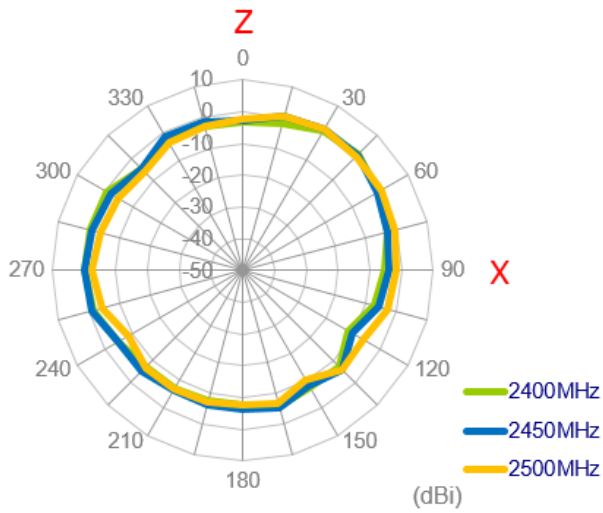

YZ Plane

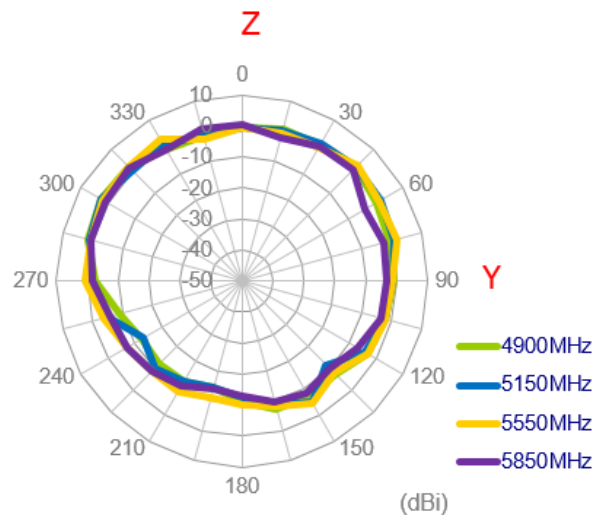
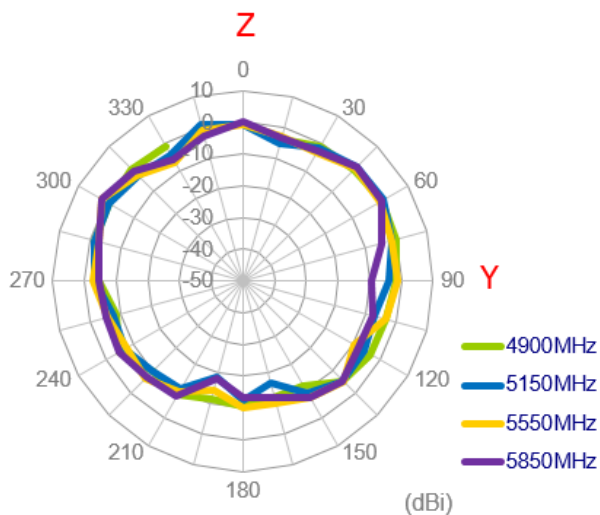

3.3.18 3D Radiation Pattern (Wi-Fi_MIMO1)

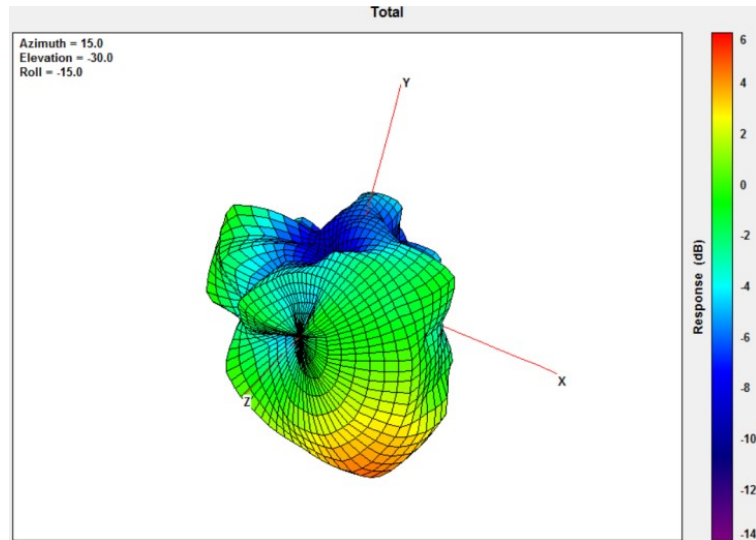

2450MHz

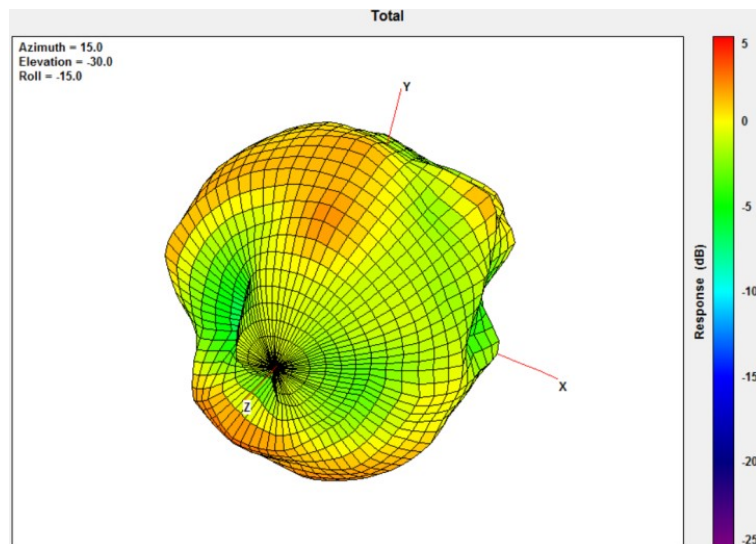

5550MHz

3.3.19 2D Radiation Pattern (Wi-Fi_MIMO2)

XY Plane

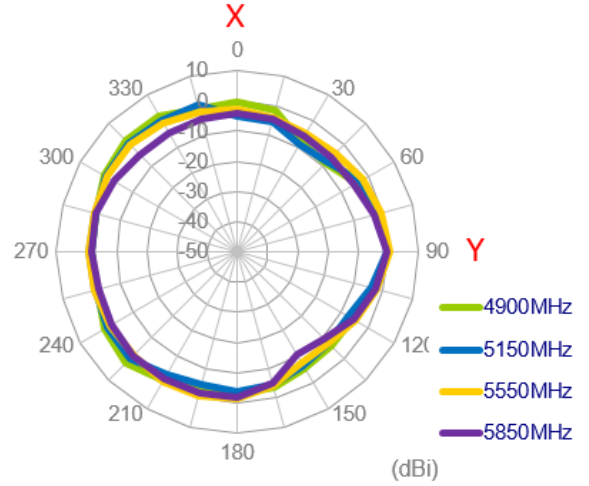
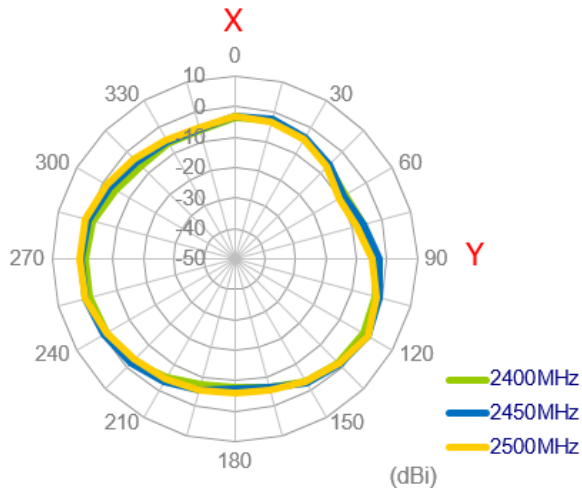

XZ Plane

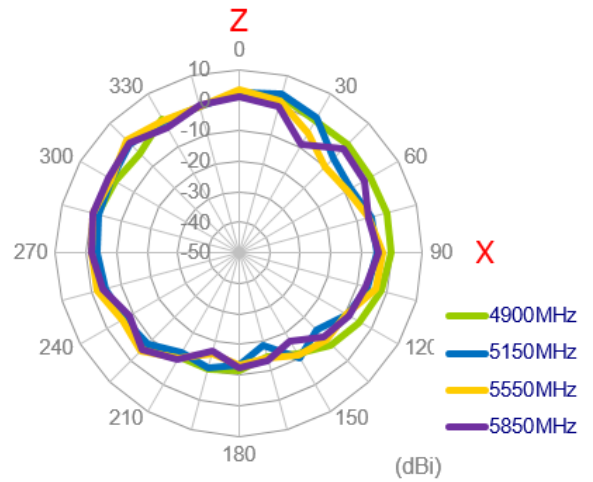
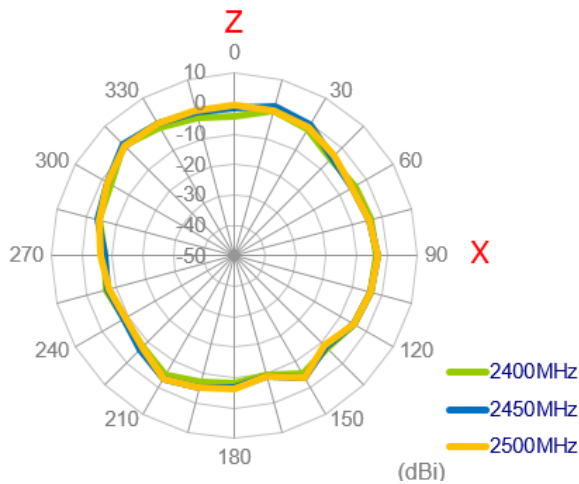

YZ Plane

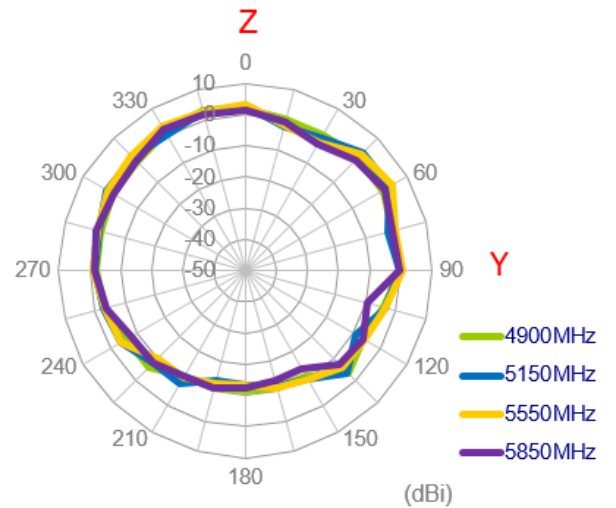
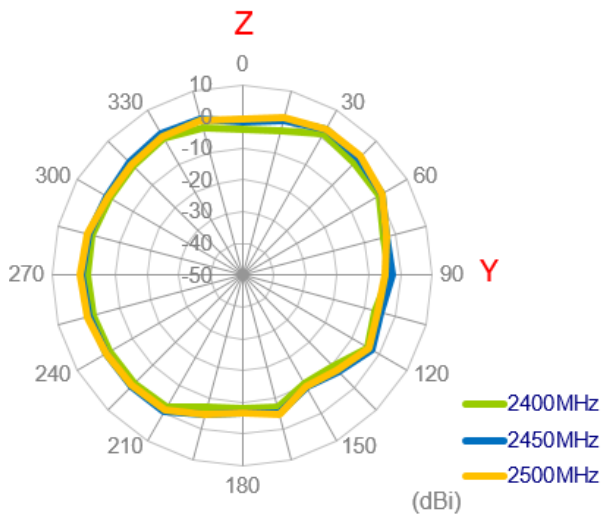

3.3.20 3D Radiation Pattern (Wi-Fi_MIMO2)

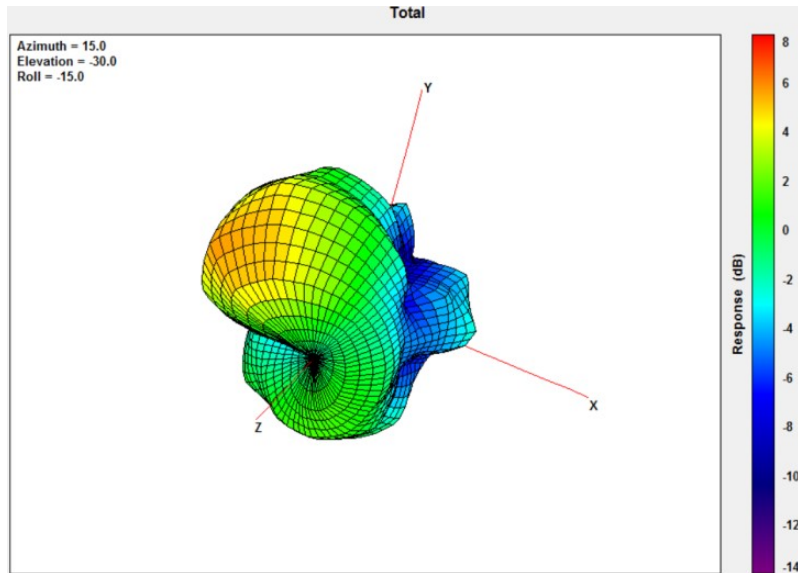

2450MHz

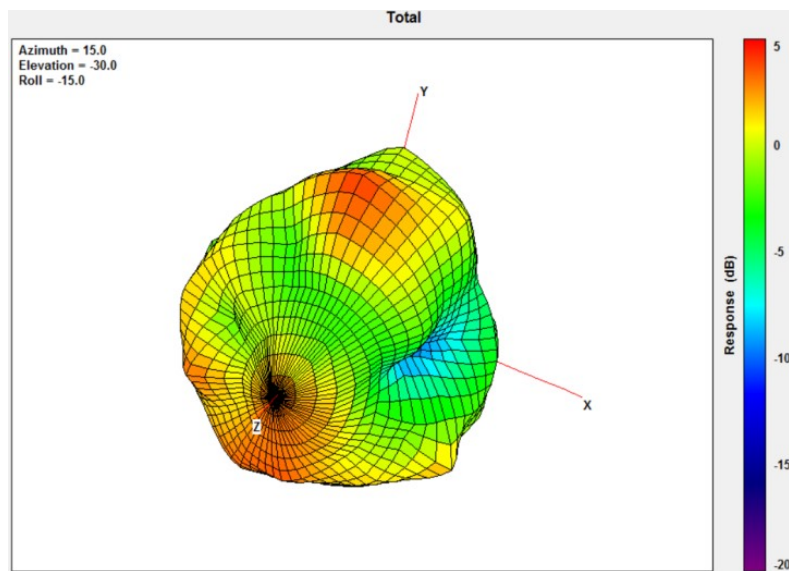

5550MHz

4. Mechanical Drawing (Unit: mm)

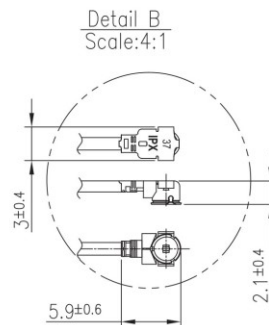
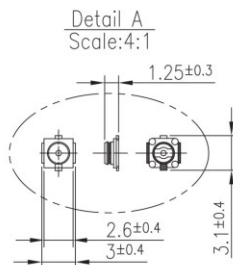
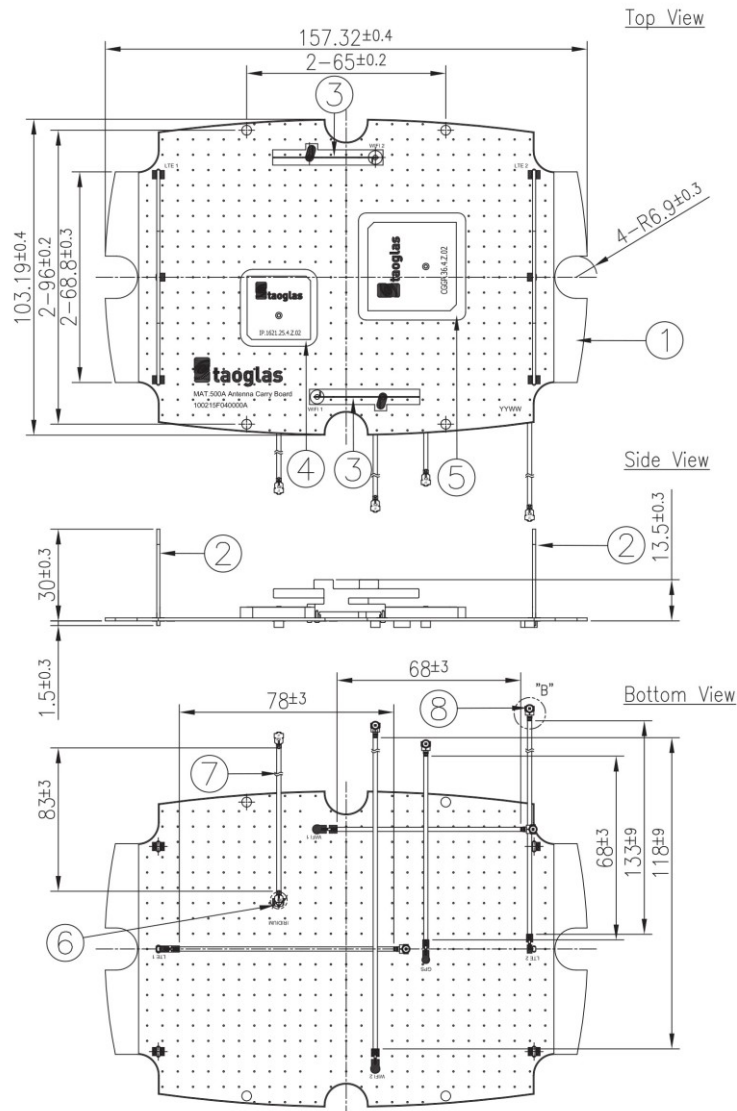

	Name	Material	Finish	QTY
1	MAT.500A Antenna Carry Board	Composite t=1.0	Black	1
2	MAT.500A LTE Antenna Board	Composite t=1.0	Black	2
3	MAT.500 WiFi Antenna	Cu-Ni-Zn Alloy,t=0.25	N/A	2
4	Iridium Antenna (25x25x4)	Ceramic patch	Clear	1
5	GNSS Antenna (36x36x4)	Ceramic patch	Clear	1
6	IPEX MHFI Receptacle	Brass	Au plated	1
7	1.37 Coaxial Cable	FEP	Black	6
8	IPEX.MHFHT	Brass	Au plated	7

5. Packaging

1 pc MAT.500A per PE bag
 Tray Dimensions - 156*260mm
 Total Weight - 780g

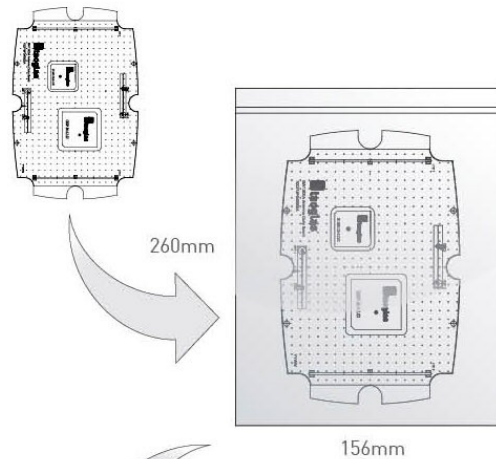

8 pc MAT.500A per inner carton
 Dimensions - 285*180*115
 Weight - 780g

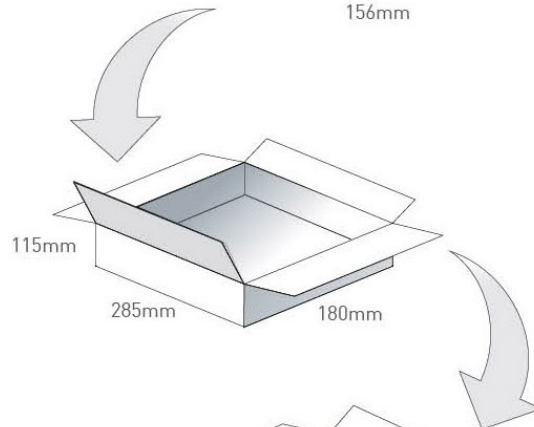

48 pc MAT.500A per outer carton
 Dimensions - 700*360*220
 Weight - 6.74Kg

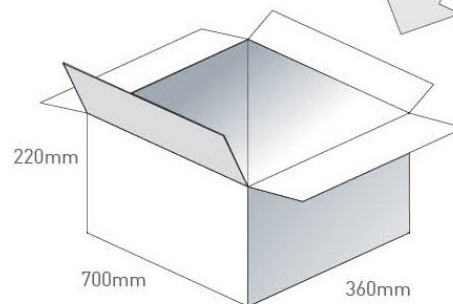

Pallet Dimensions 1060mm*720mm*1470mm
 18 Cartons per pallet
 6 Cartons per layer
 3 Layers

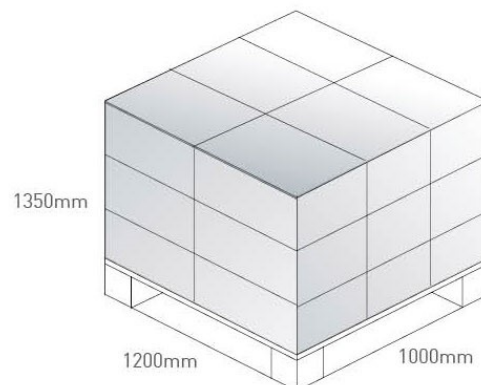

Taoglas makes no warranties based on the accuracy or completeness of the contents of this document and reserves the right to make changes to specifications and product descriptions at any time without notice. Taoglas reserves all rights to this document and the information contained herein.

Reproduction, use or disclosure to third parties without express permission is strictly prohibited.

Copyright © Taoglas Ltd.

X-ON Electronics

Largest Supplier of Electrical and Electronic Components

Click to view similar products for [Antenna Development Tools](#) category:

Click to view products by [Taoglas](#) manufacturer:

Other Similar products are found below :

[0868AT43A0020-EB1SMA](#) [EVALBGSA141MN10TOBO1](#) [A10393-U1](#) [PCSD.06.A](#) [B5771-U1](#) [KIT-LTE-GNSS-01](#) [KIT-WIFI-ISM-01](#)
[A10472-U1](#) [REFLECTOR-EVB-1](#) [A10340-U1](#) [ACAG0201-2450-EVB](#) [ACAG0301-15752450-EVB](#) [ACAG0301-1575-EVB](#) [ACAG0301-24505500-EVB](#) [ACAG0301-5500-EVB](#) [ACAG0801-2450-EVB](#) [ACAG1204-433-EVB](#) [ACAG1204-868-EVB](#) [ACAG1204-915-EVB](#)
[ACAR0301-SW2-EVB](#) [ACAR3005-C2WB-EVB](#) [ACAR3005-S824-EVB](#) [ACAR3705-S698-EVB](#) [ACAR4008-S698-EVB](#) [A10137-D](#)
[A10194-U1](#) [A10204-U1](#) [A5645H-EVB-1](#) [A5645-U1](#) [A5887H-EVB-1](#) [A6111-U1](#) [M20057-EVB-1](#) [SR42W001-U1](#) [SR42W009-U1](#)
[SR4G008-U1](#) [SR4G013-U1](#) [SR4G053-EVB-1](#) [SR4L049-EVB-1](#) [SRC5G027-U1](#) [SRCW004-U1](#) [1001312-01](#) [M310220-01](#) [M620720-01](#)
[M830120-01](#) [M830520-01](#) [EB_NN01-105A](#) [EB_NN02-201-5G](#) [CCKLTE450-NA](#) [AEK-GNCP-TH258L15](#) [MPA-104- KIT](#)