



Datasheet

WarriorX

Part No:
PA.760.A

Description:

WarriorX Wideband (600-6000MHz) Antenna for 5G NR & 4G Bands

Features:

Patent Pending Innovative Design

High Efficiency Wideband Antenna, Covering 600 to 6000 MHz

Supporting all 5G NR Bands

600MHz 5G/4G Band 71 Support

Surface Mount Distribution (SMD) - Supplied on Tape & Reel

Dimensions: 40 x 5 x 6 mm

Manufactured in an IATF16949 Certified Facility

RoHS & REACH Compliant

1. Introduction	3
2. Specifications	4
3. Antenna Characteristics	6
4. Radiation Patterns	8
5. Mechanical Drawing	20
6. Antenna Integration Guide	21
7. Packaging	30
8. Application Note	31
9. Solder Reflow Temperature	35
<hr/>	
Changelog	36

Taoglas makes no warranties based on the accuracy or completeness of the contents of this document and reserves the right to make changes to specifications and product descriptions at any time without notice. Taoglas reserves all rights to this document and the information contained herein. Reproduction, use or disclosure to third parties without express permission is strictly prohibited.



1. Introduction



The Taoglas, WarriorX PA.760.A is a patent pending 5G/4G, high-efficiency, wideband(600-6000MHz) SMD ceramic antenna, designed to cover newly established 5G NR bands for worldwide deployment and worldwide 4G bands. It uses high grade custom ceramic and innovative design techniques to deliver the highest efficiencies in a small footprint across all bands when mounted on the device's main PCB.

The PA.760 is backward compatible for global 3G/2G applications if required. The PA.760 is delivered on tape and reel and mounted securely during the device PCB reflow process. The PA.760 also operates with great efficiency on worldwide NB-IoT and CAT-M frequency bands.

Typical applications include:

- Transportation
- Robotics
- Wearables
- Autonomous/UAVs
- Industrial IoT

The PA.760 is more resistant to detuning compared to other antenna integrations. If tuning is required it can be tuned for the device environment using a matching circuit, or other techniques on the main PCB itself. There is no need for new tooling, thereby saving money if customization is required.

The PA.760.A is manufactured in our IATF16949 approved production facility and made from highly reliable and robust ceramic that is currently used by world leading automotive manufacturers in extremely challenging environments.

The PA.760 has a small profile, 40*6*5mm, allowing for ease of integration. Contact your regional Taoglas customer support team to request these services or additional support to integrate and test this antenna's performance in your device.

2. Specifications

Electrical							
Band	Frequency (MHz)	Efficiency (%)	Average Gain (dB)	Peak Gain (dBi)	Impedance	Polarization	Radiation Pattern
5G NR/4G Band 71	617~698	40.5	-3.9	-0.7	50 Ω	Linear	Omni
4G/3G Band 12,13,14,17,28,29	698~806	49.6	-3.1	0.5			
4G/3G Band 5,8,18,19,20,26,27	824~960	53.2	-2.7	1			
5G NR/4G Band 21,32,74,75,76	1427~1518	28.8	-5.4	-0.5			
4G/3G Band 1,2,3,4,9,23,25,35,39,66	1710~2200	66.8	-1.7	3.4			
4G/3G Band 7,38,41	2490~2690	53.8	-2.7	2.9			
5G NR Band 22,42,48,77,78,79	3300~5000	42.6	-3.7	4.3			
LTE5200/ Wi-Fi 5800	5150~5925	51.5	-2.9	3			

*The PA.760.A antenna performance was measured on a 120x45 ground plane (PAD.760.A)

Mechanical	
Dimensions	40*6*5mm
Material	Ceramic
Termination	Ag (environmental Pb free) - Solder Pad
EVB Connector	SMA-Female
Weight	3g
Environmental	
Temperature Range	-40°C to 85°C
Moisture Sensitivity	Level 3

5G/4G Bands			
Band Number	5GNR / FR1 / LTE / LTE-Advanced / WCDMA / HSPA / HSPA+ / TD-SCDMA		
	Uplink	Downlink	Covered
1	UL: 1920 to 1980	DL: 2110 to 2170	✓
2	UL: 1850 to 1910	DL: 1930 to 1990	✓
3	UL: 1710 to 1785	DL: 1805 to 1880	✓
4	UL: 1710 to 1755	DL: 2110 to 2155	✓
5	UL: 824 to 849	DL: 869 to 894	✓
7	UL: 2500 to 2570	DL: 2620 to 2690	✓
8	UL: 880 to 915	DL: 925 to 960	✓
9	UL: 1749.9 to 1784.9	DL: 1844.9 to 1879.9	✓
11	UL: 1427.9 to 1447.9	DL: 1475.9 to 1495.9	✓
12	UL: 699 to 716	DL: 729 to 746	✓
13	UL: 777 to 787	DL: 746 to 756	✓
14	UL: 788 to 798	DL: 758 to 768	✓
17	UL: 704 to 716	DL: 734 to 746	✓
18	UL: 815 to 830	DL: 860 to 875	✓
19	UL: 830 to 845	DL: 875 to 890	✓
20	UL: 832 to 862	DL: 791 to 821	✓
21	UL: 1447.9 to 1462.9	DL: 1495.9 to 1510.9	✓
22	UL: 3410 to 3490	DL: 3510 to 3590	✓
23	UL: 2000 to 2020	DL: 2180 to 2200	✓
24	UL: 1625.5 to 1660.5	DL: 1525 to 1559	✓
25	UL: 1850 to 1915	DL: 1930 to 1995	✓
26	UL: 814 to 849	DL: 859 to 894	✓
27	UL: 807 to 824	DL: 852 to 869	✓
28	UL: 703 to 748	DL: 758 to 803	✓
29	UL: -	DL: 717 to 728	✓
30	UL: 2305 to 2315	DL: 2350 to 2360	✓
31	UL: 452.5 to 457.5	DL: 462.5 to 467.5	✗
32	UL: -	DL: 1452 – 1496	✓
35		1850 to 1910	✓
38		2570 to 2620	✓
39		1880 to 1920	✓
40		2300 to 2400	✓
41		2496 to 2690	✓
42		3400 to 3600	✓
43		3600 to 3800	✓
48		3550 to 3700	✓
66	UL: 1710-1780	DL: 2110-2200	✓
71		617 to 698	✓
74/75/76		1427 to 1518	✓
77		3300 to 4200	✓
78		3300 to 3800	✓
79		4400 to 5000	✓

3. Antenna Characteristics

3.1 Return Loss

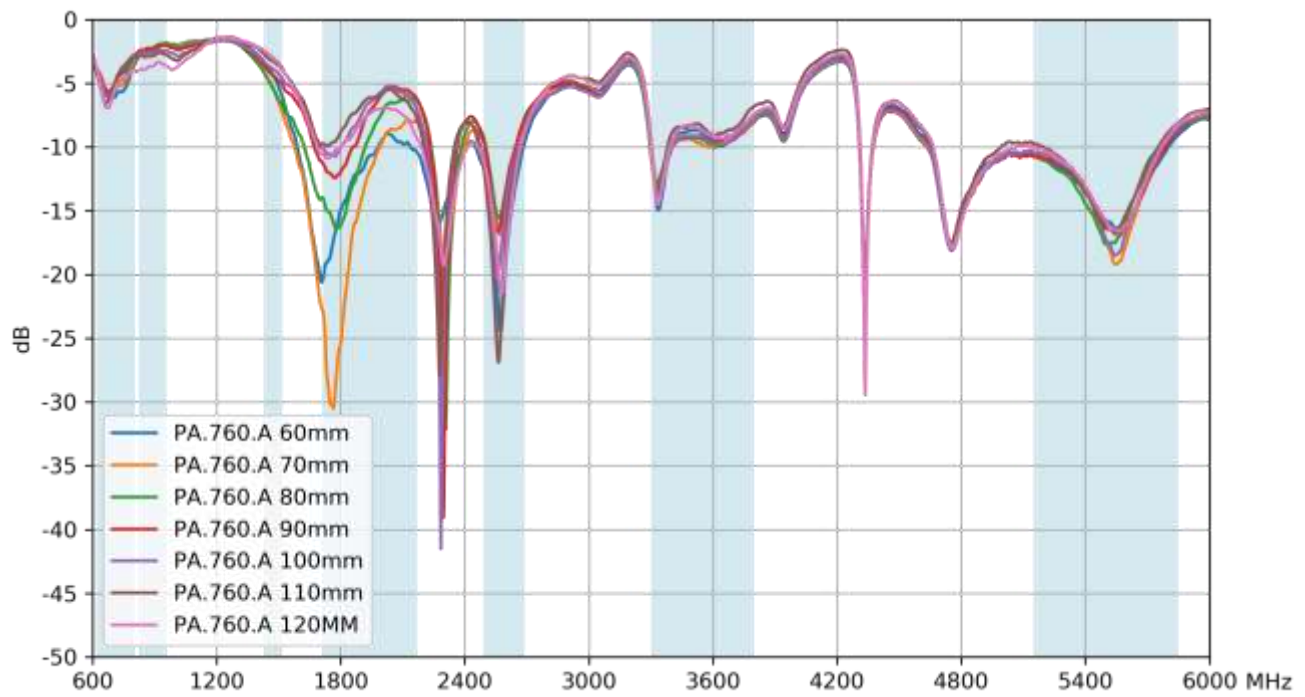

3.2 Efficiency

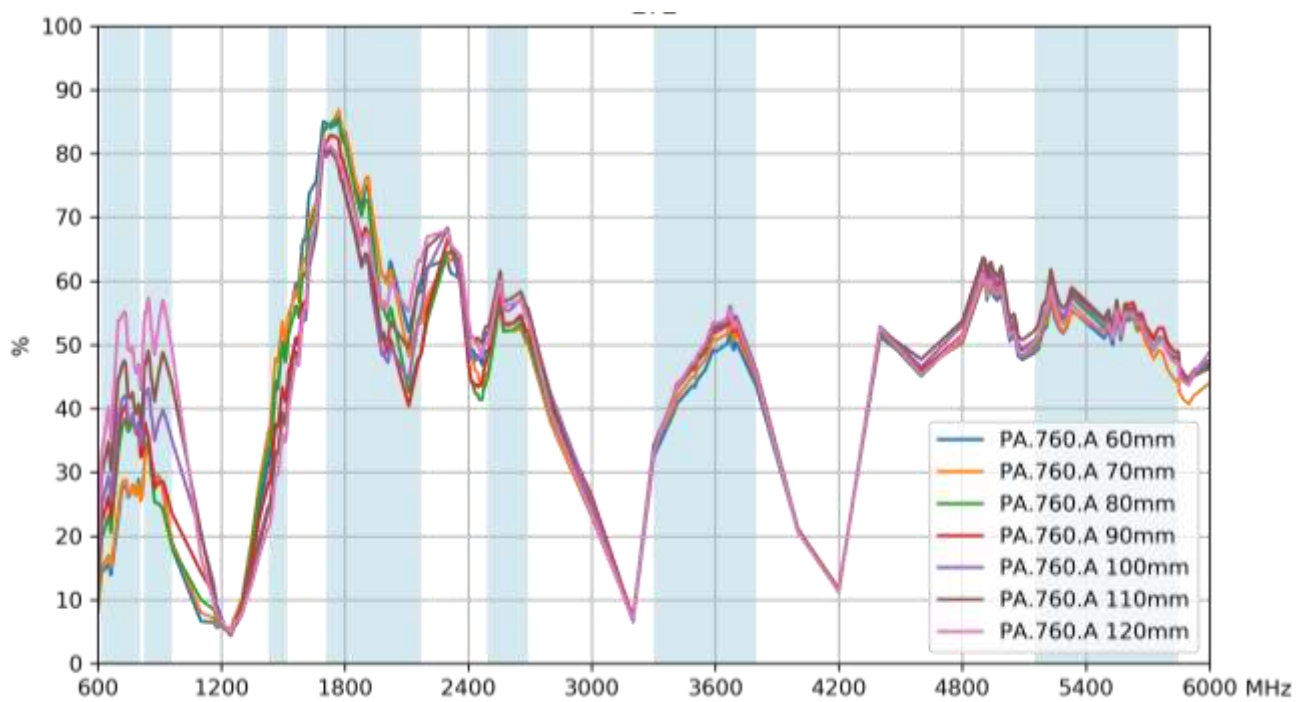

3.3 Average Gain

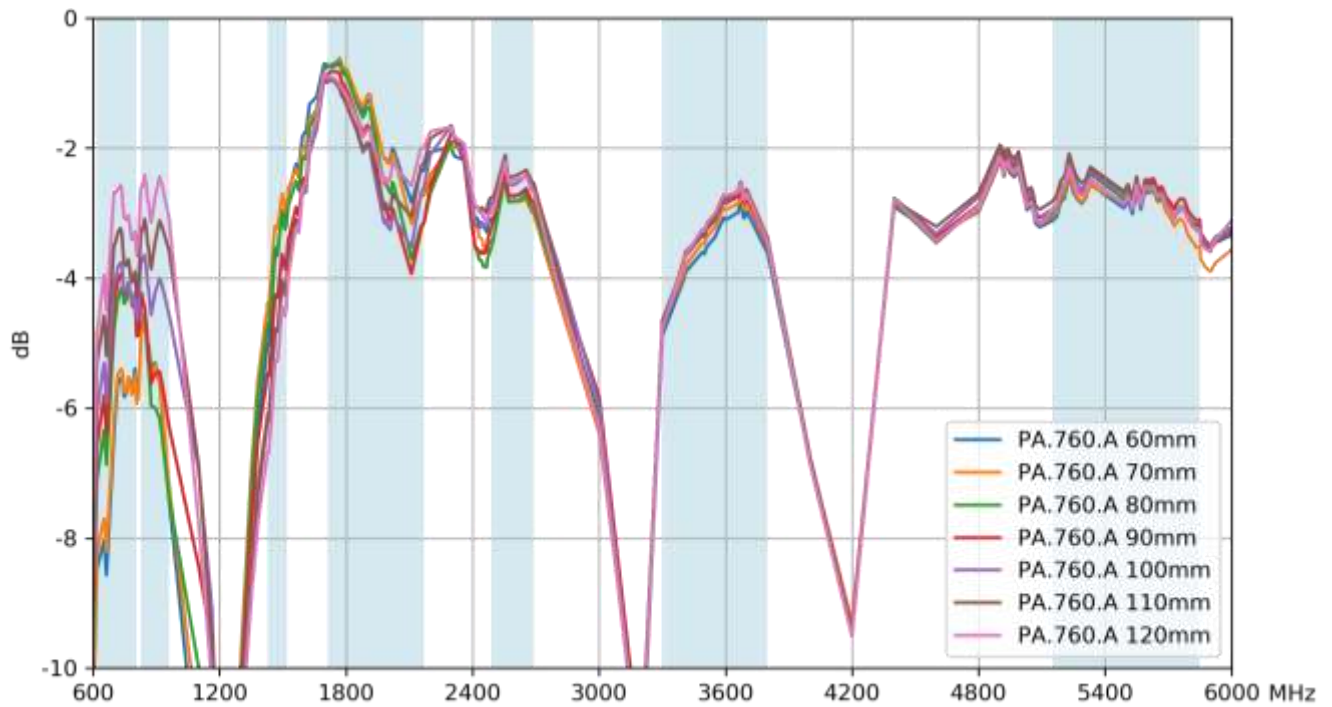

3.4 Peak Gain

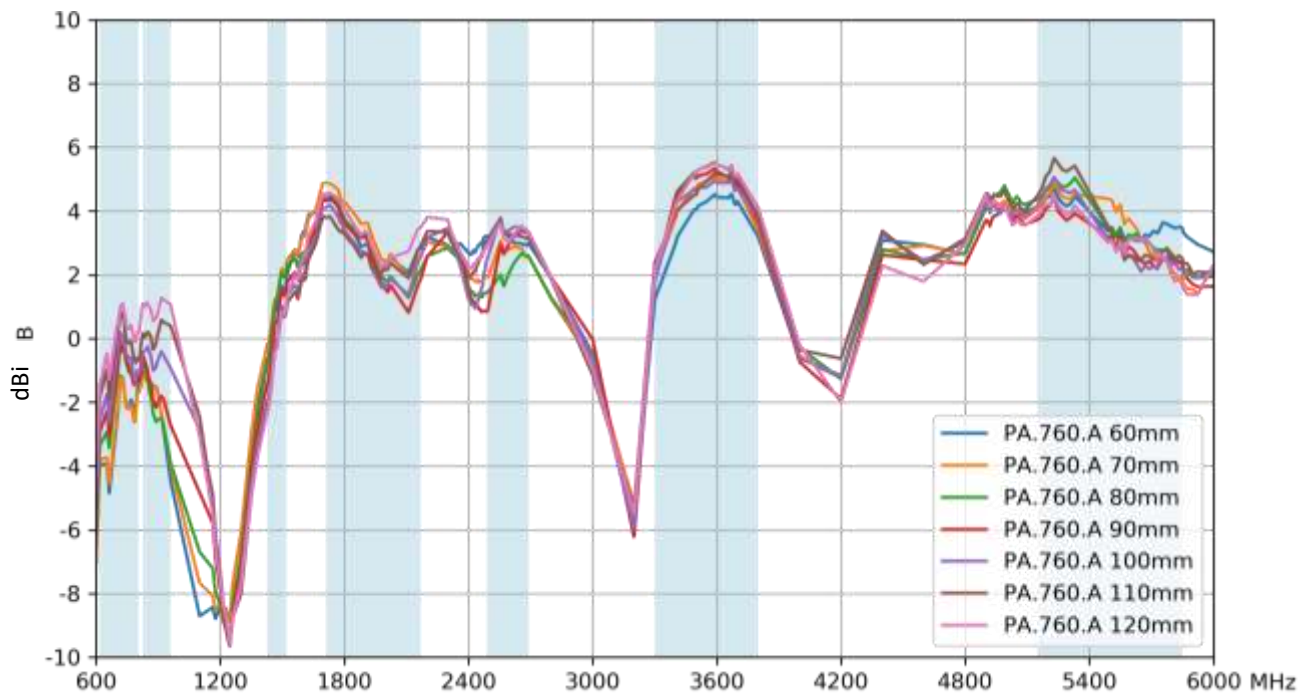

4. 2D Radiation Patterns

4.1 Test Setup



Tested on PAD.760.A Evaluation board(120x45mm)

4.2 On Evaluation Board 120*45mm 2D & 3D Radiation Patterns

600MHz

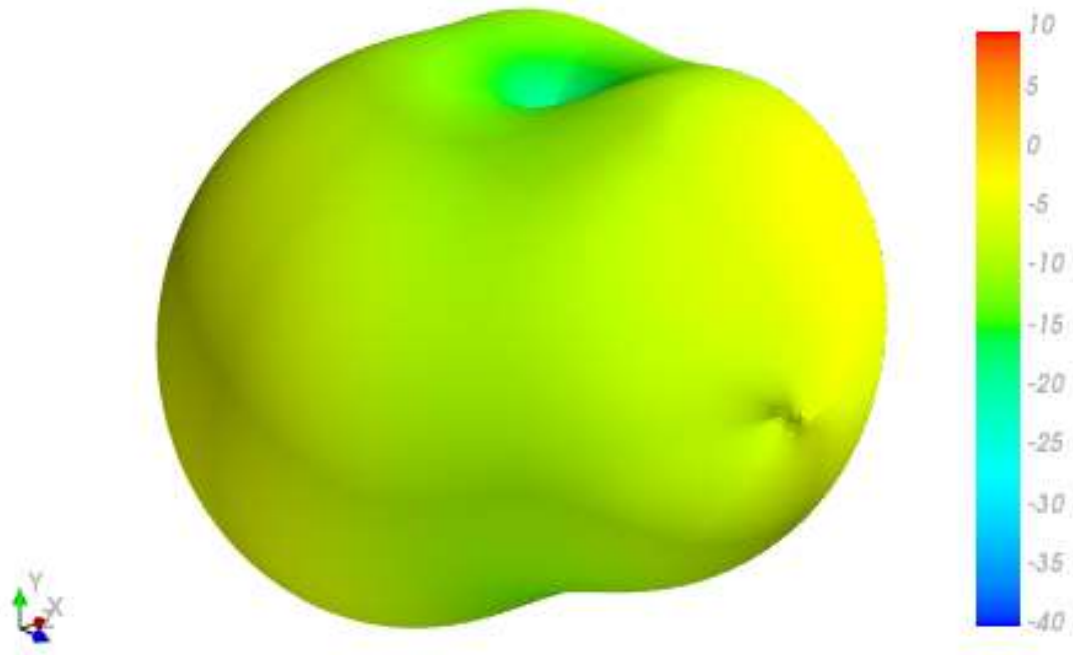

XY Plane

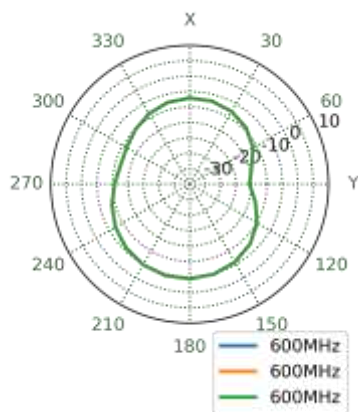

XZ Plane

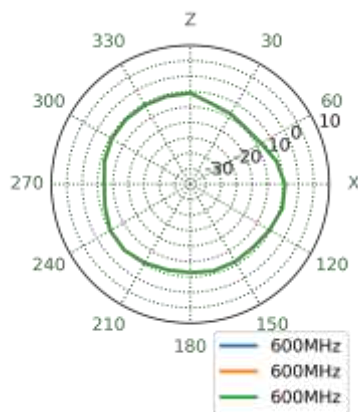

YZ Plane

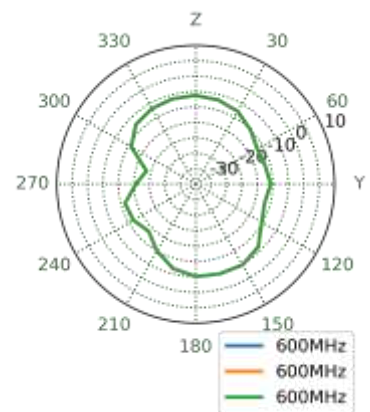

652MHz

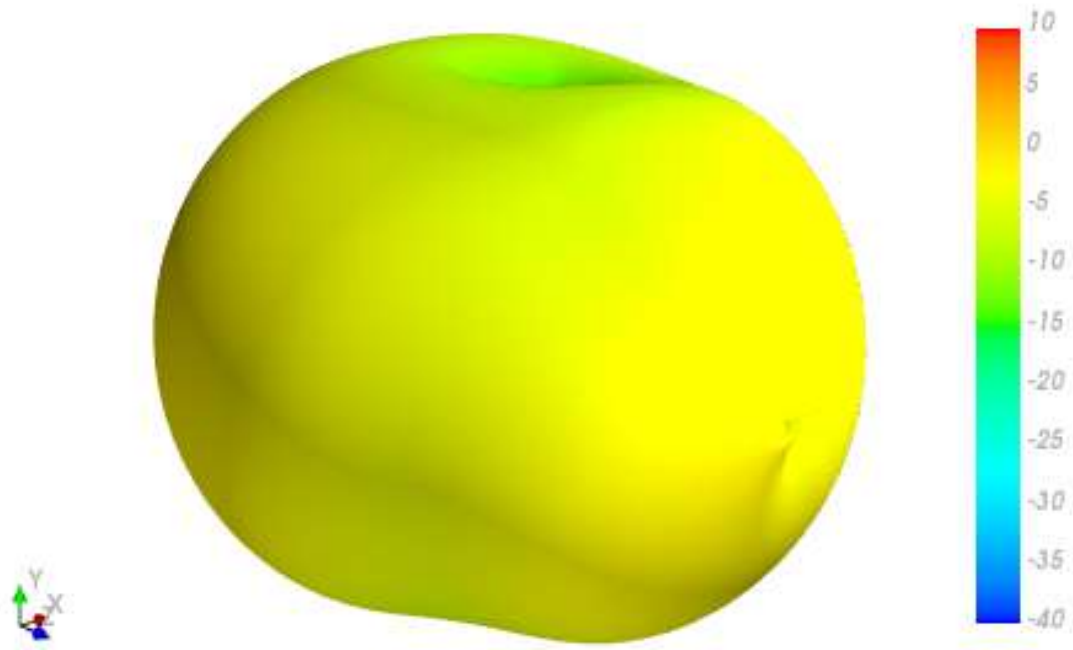

XY Plane

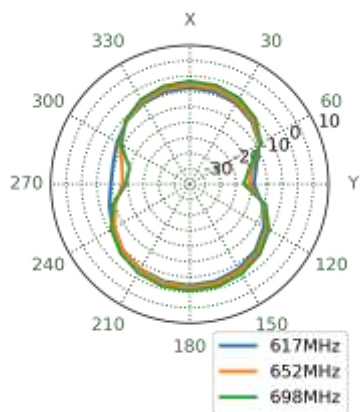

XZ Plane

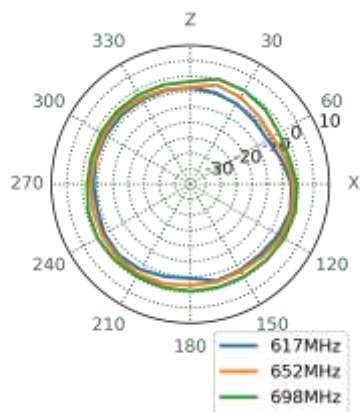

YZ Plane

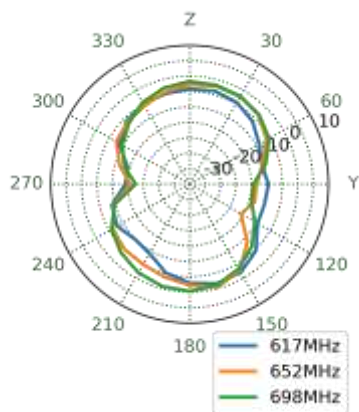

751MHz

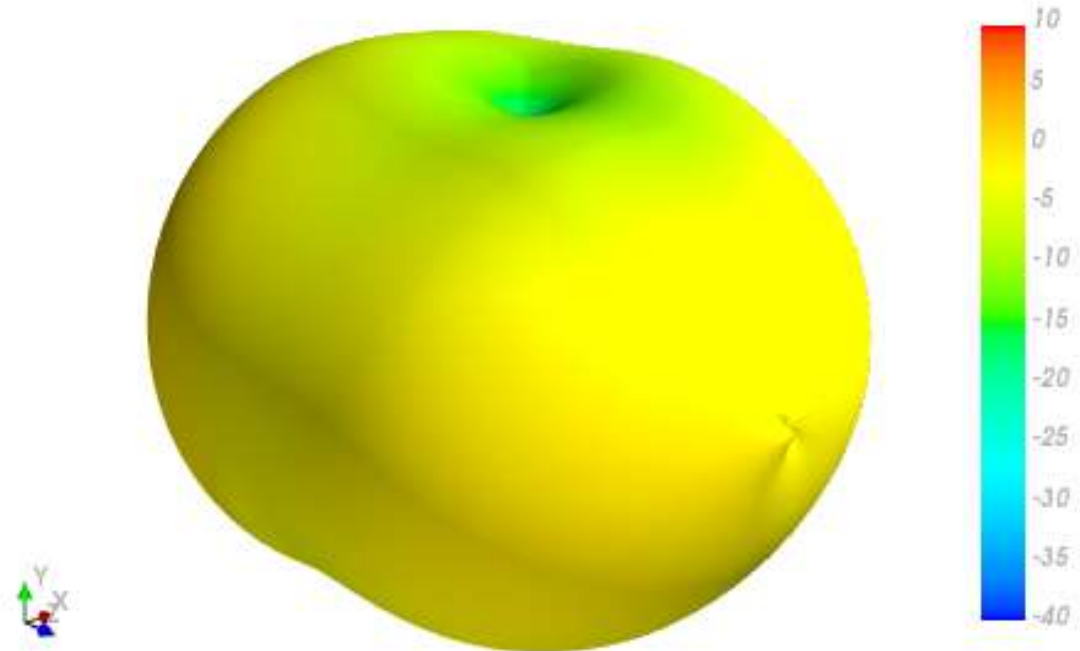

XY Plane

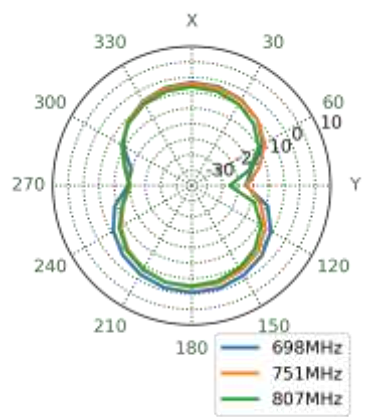

XZ Plane

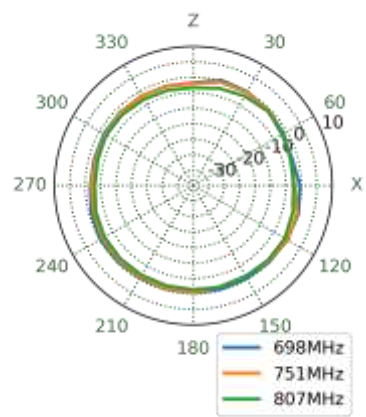

YZ Plane

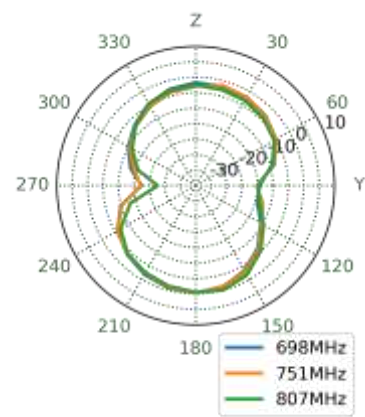

890MHz

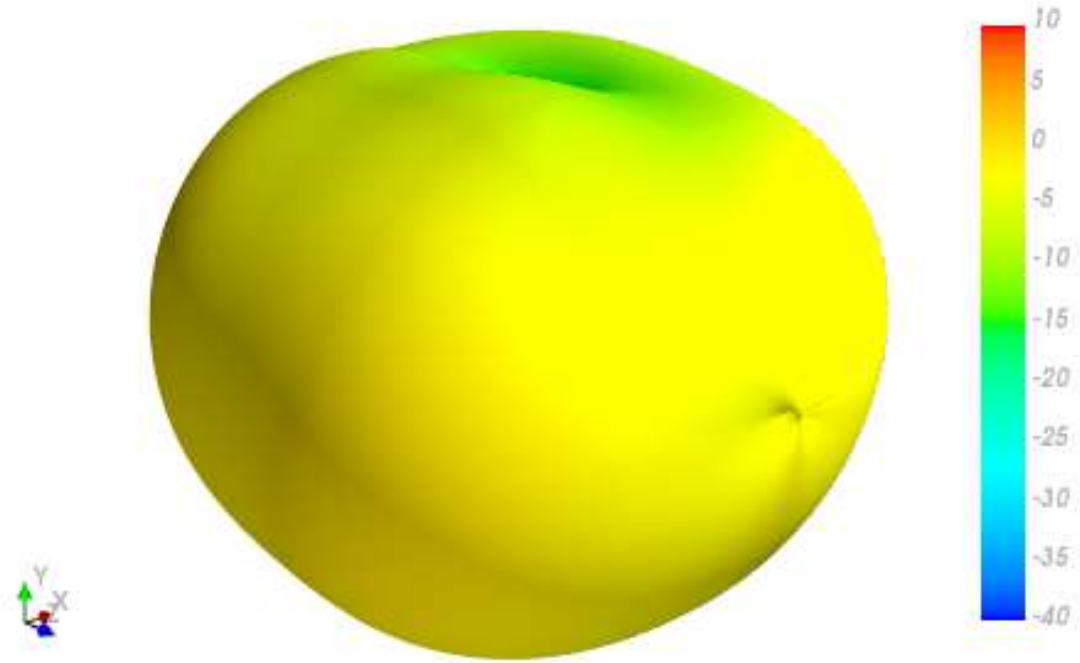

XY Plane XZ Plane YZ Plane

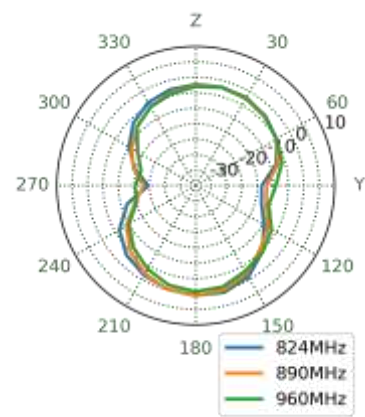
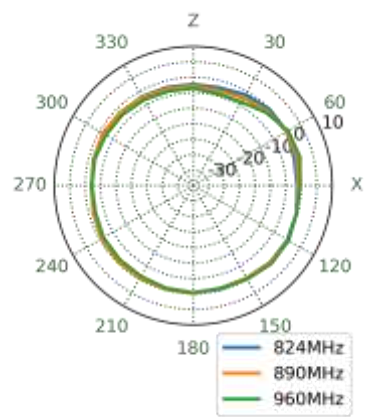
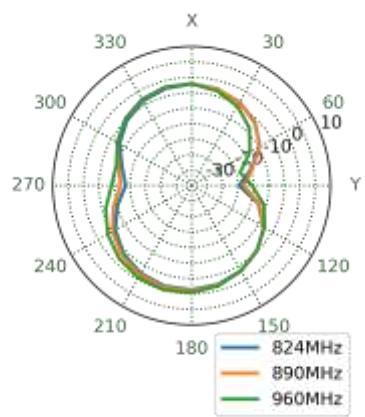

1470MHz

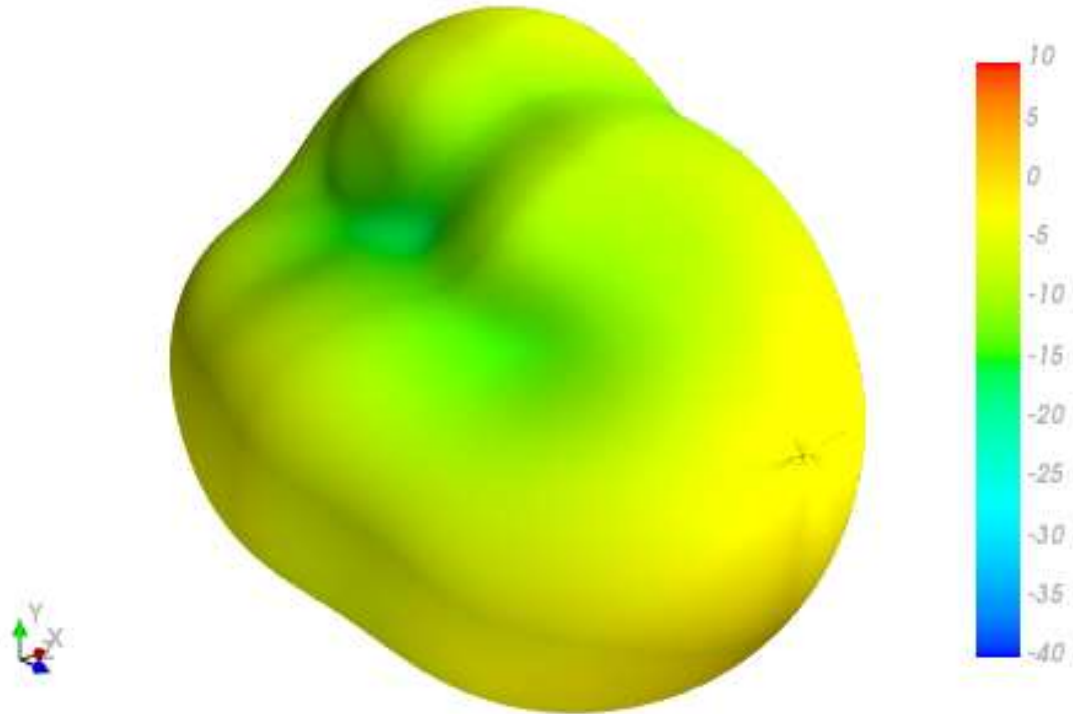

XY Plane

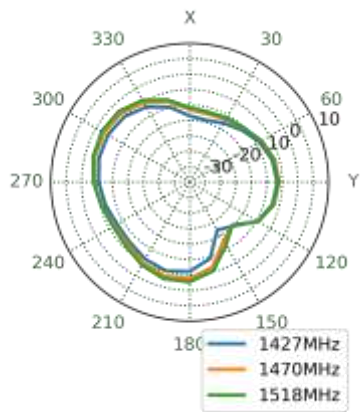

XZ Plane

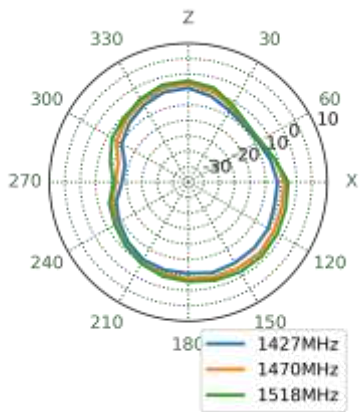

YZ Plane

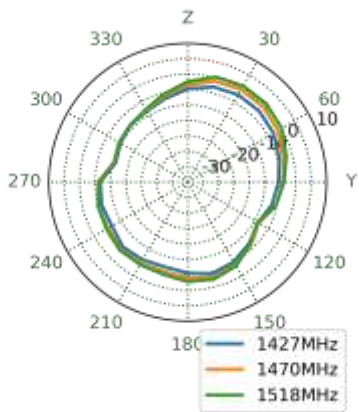

1805MHz

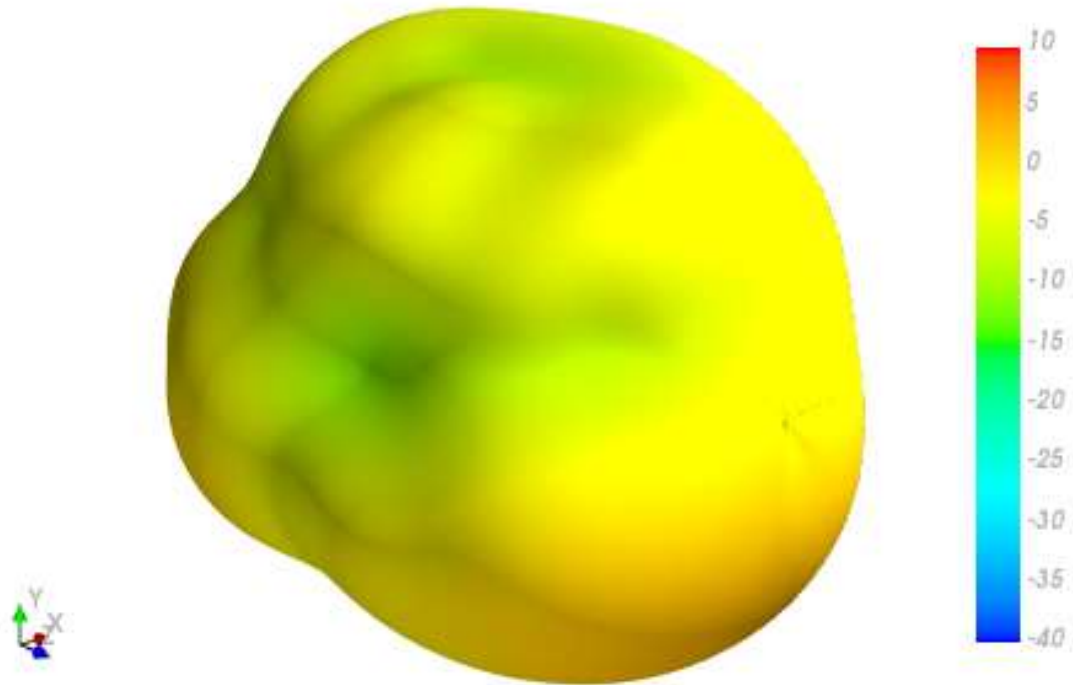

XY Plane

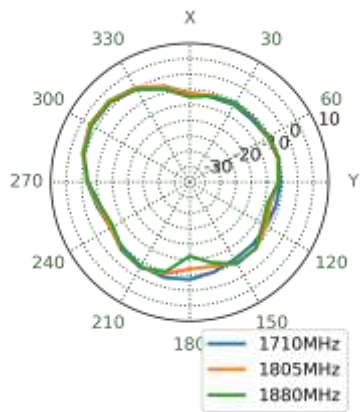

XZ Plane

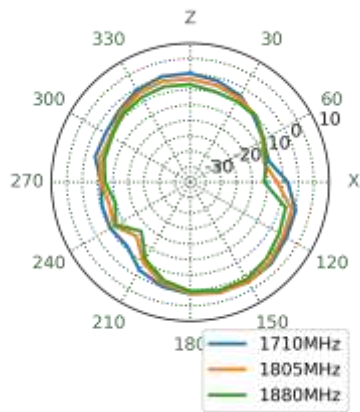

YZ Plane

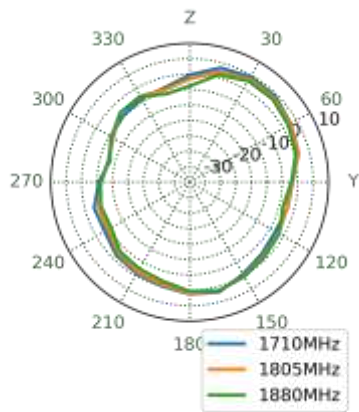

1920MHz

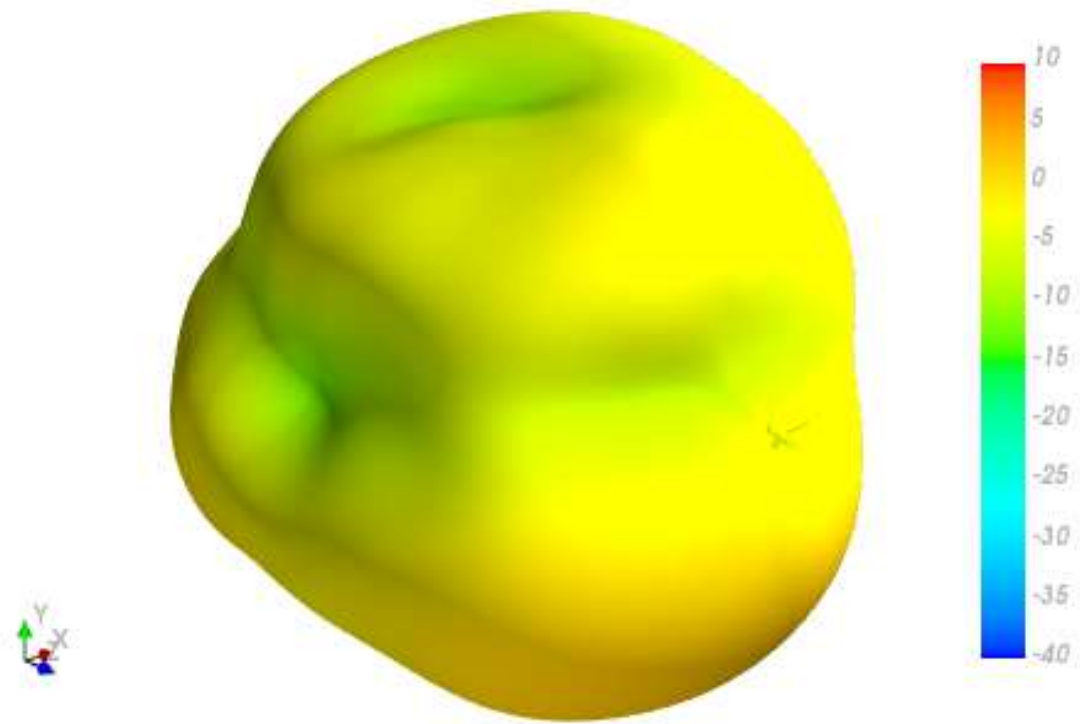

XY Plane XZ Plane YZ Plane

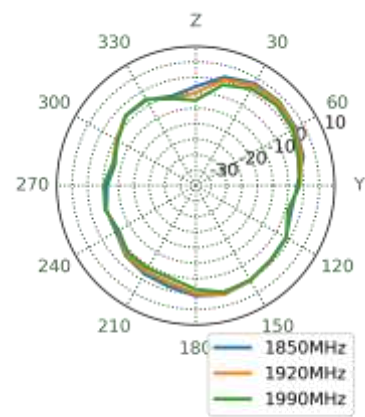
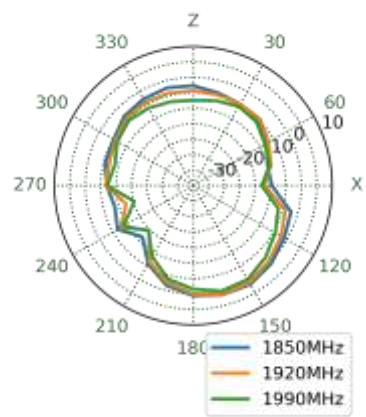
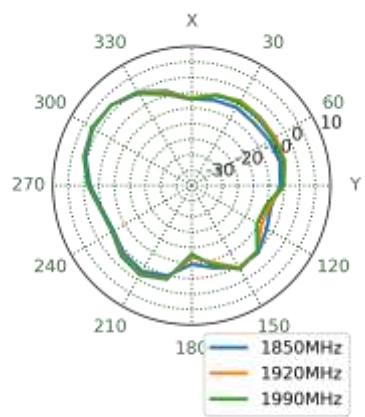

1990MHz

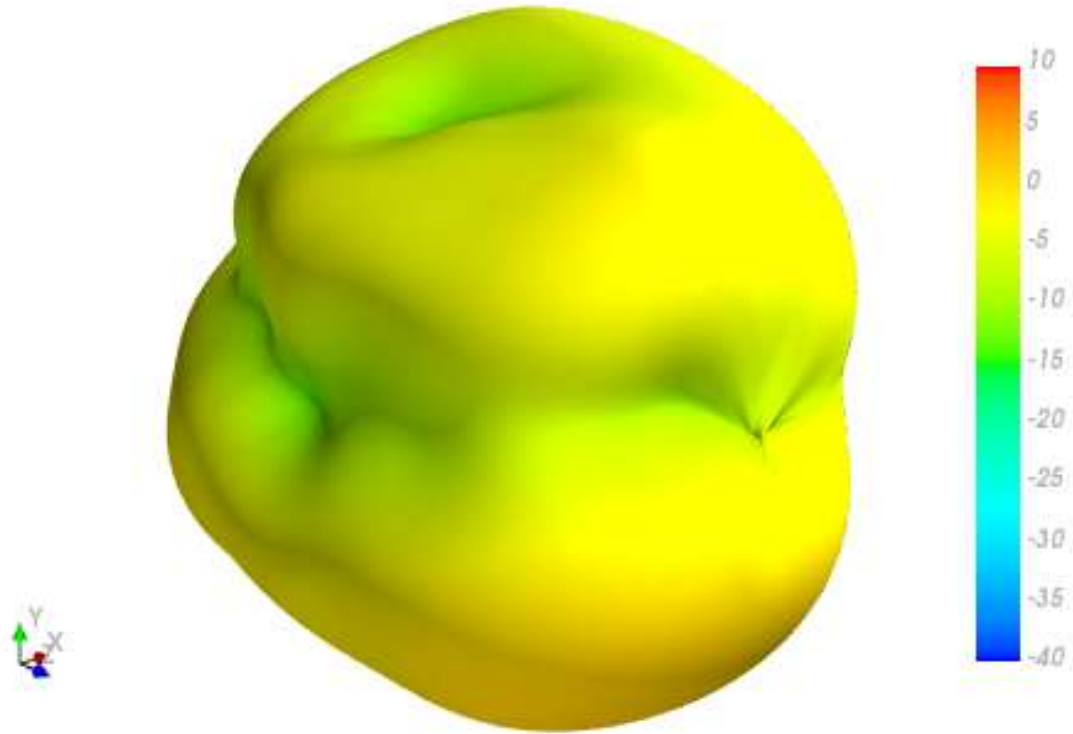

XY Plane

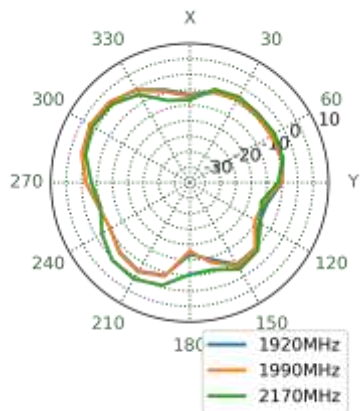

XZ Plane

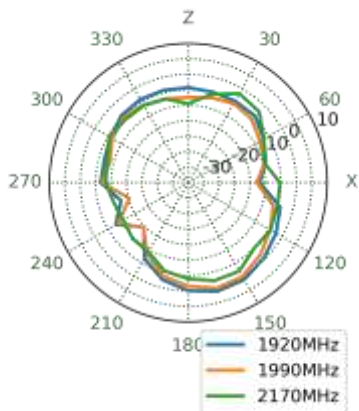

YZ Plane

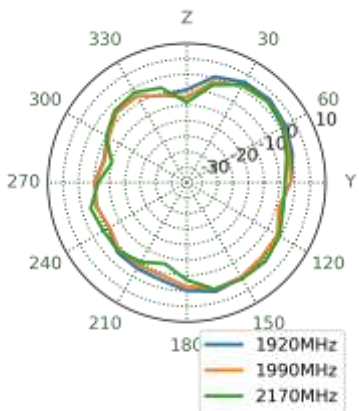

2595MHz

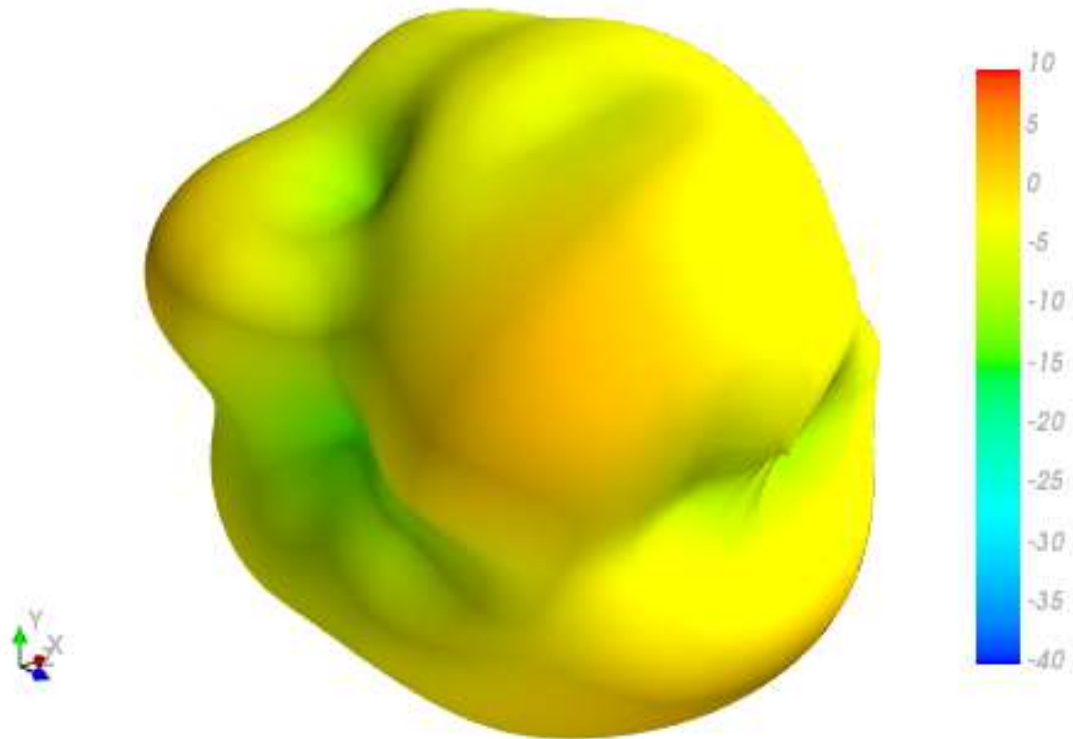

XY Plane

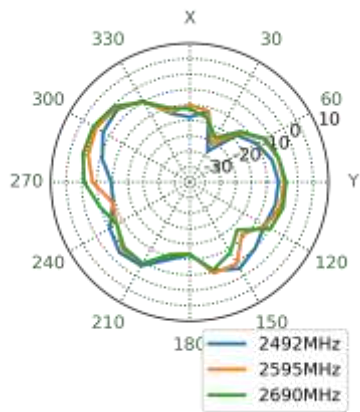

XZ Plane

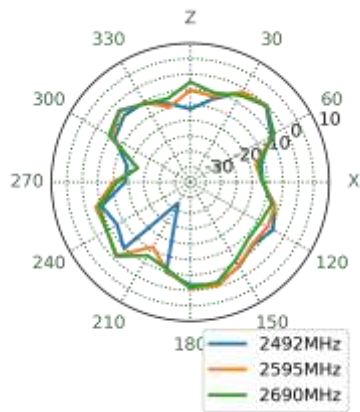

YZ Plane

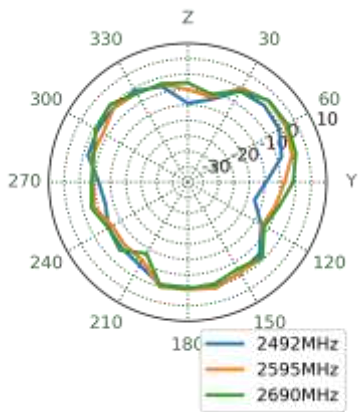

3550MHz

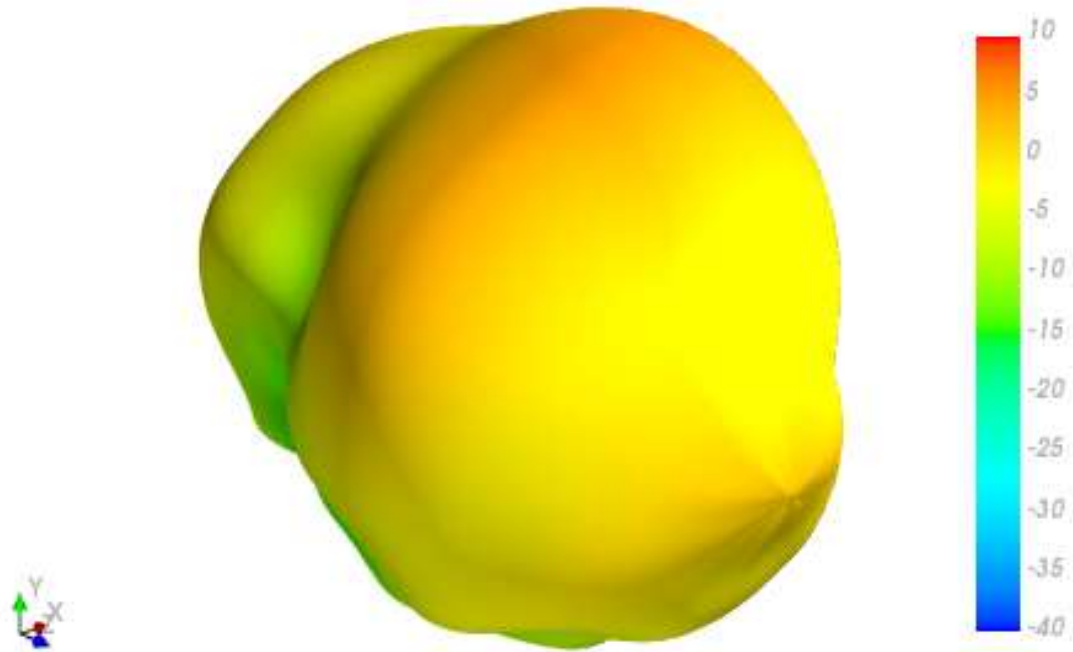

XY Plane

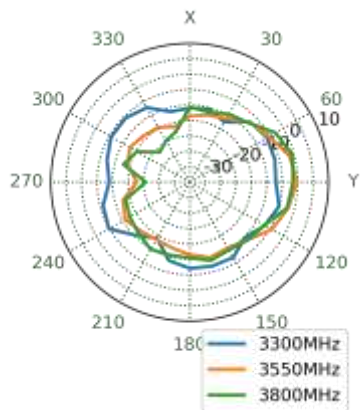

XZ Plane

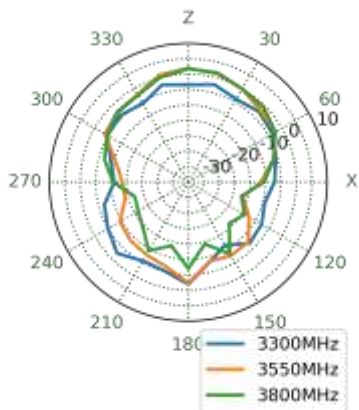

YZ Plane

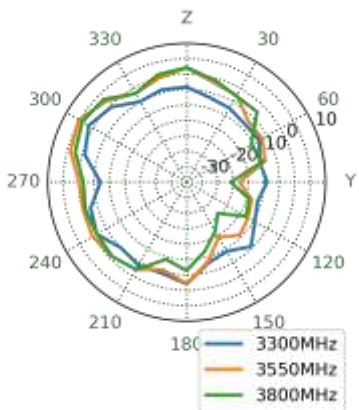

5530MHz

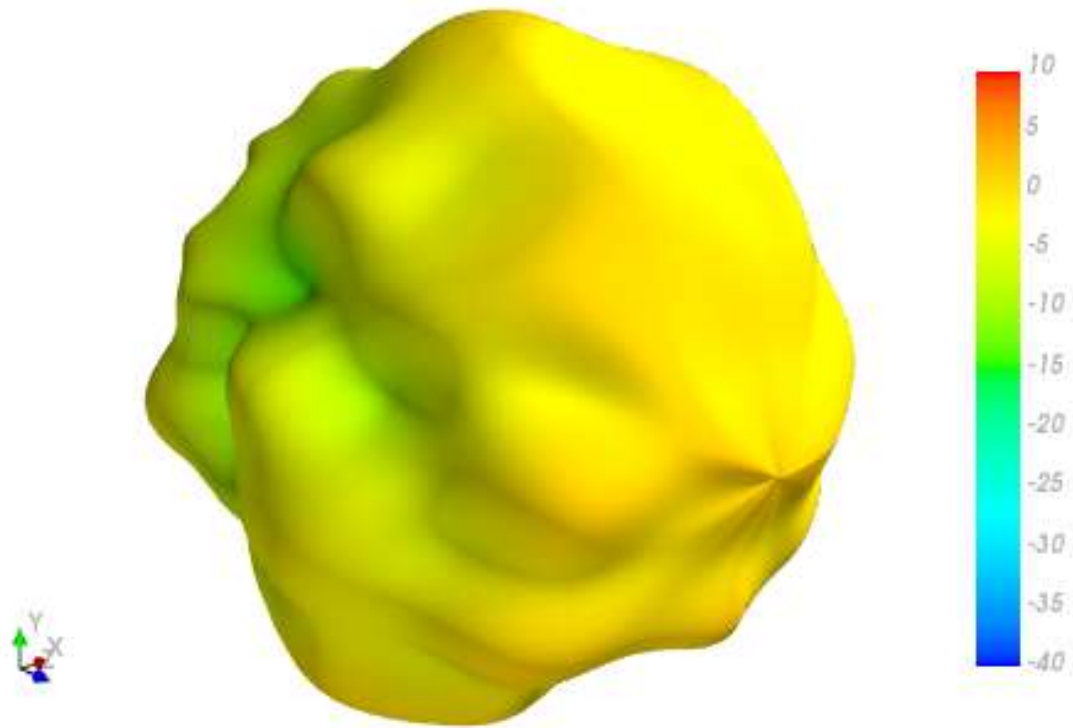

XY Plane

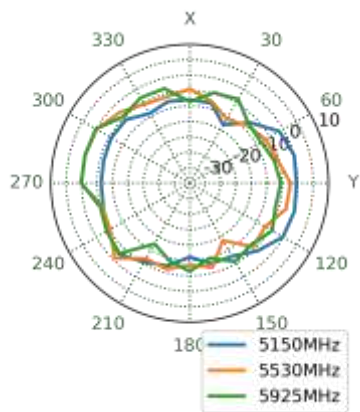

XZ Plane

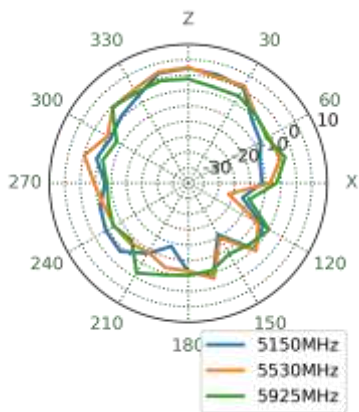

YZ Plane

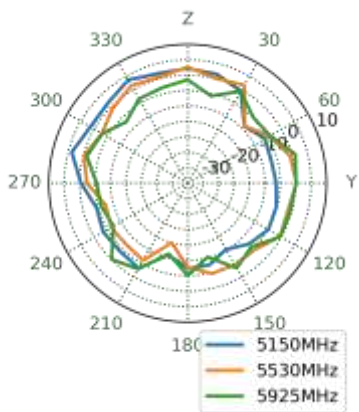

5. Mechanical Drawing (Units: mm)

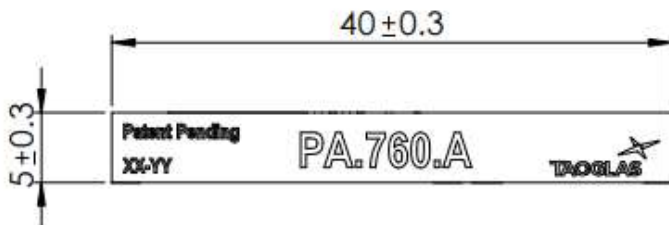

TOP VIEW

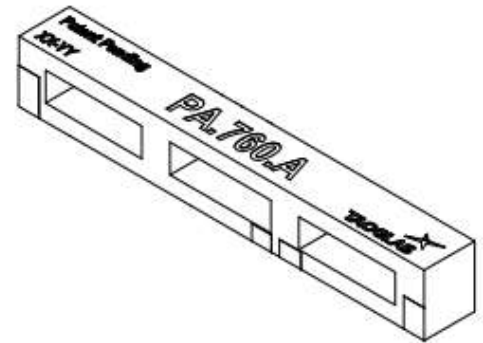

ISOMETRIC VIEW

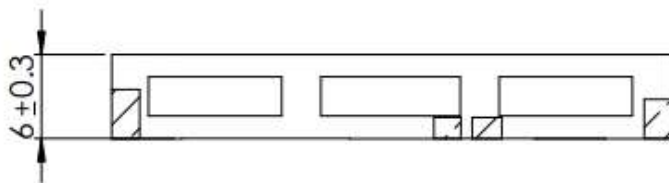

FRONT VIEW

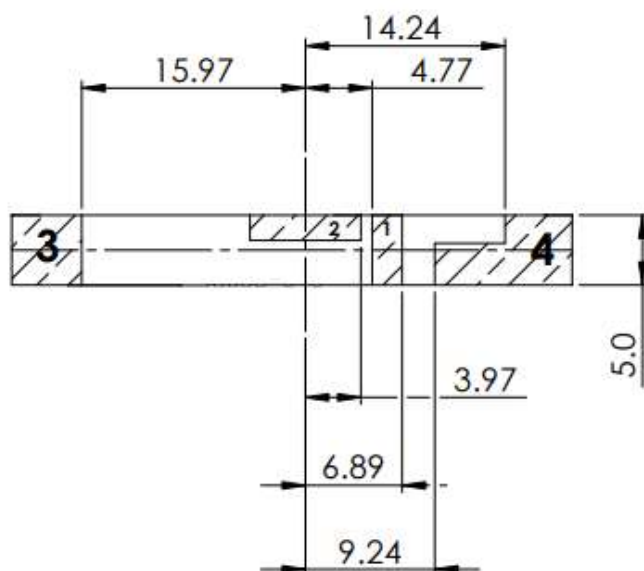

BOTTOM VIEW

6. Antenna Integration Guide



6.1 Schematic Symbol and Pin Definition

The circuit symbol for the antenna is shown below. The antenna has 4 pins with only two pins (Pin 1 and Pin 2) as functional. Pins 3 and 4 are for mechanical strength.

Pin	Description
1	RF Feed
2	Ground
3, 4	Mechanical, Not Connected

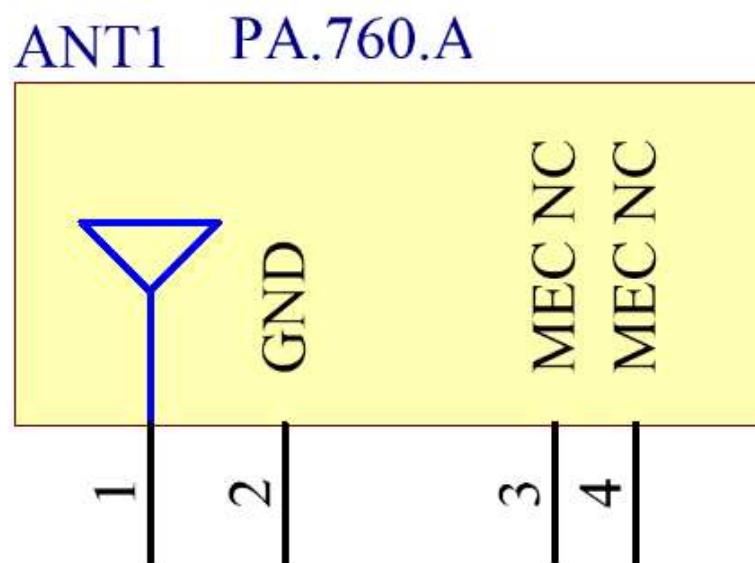

6.2 Antenna Integration

Whatever the size of the PCB, the antenna should ideally be placed on the PCB's shortest side, to take advantage of the ground plane. Optimized matching components can be placed as shown.

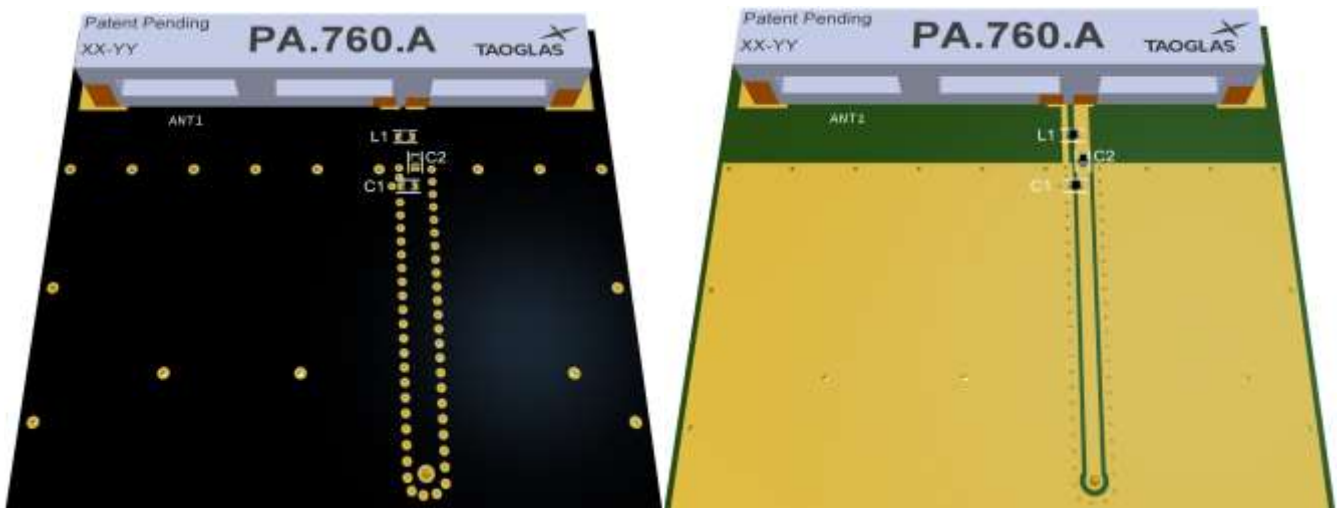

6.3 PCB Layout

The footprint and clearance on the PCB must meet the antenna specification. An example of the PCB layout shows the antenna footprint with clearance. Note the placement of the optimized components. L1 is positioned outside the ground plane and C2 is sitting across the ground plane and the copper clearance area. C1 is optional as a component but it is recommended to include these pads in case they are needed.

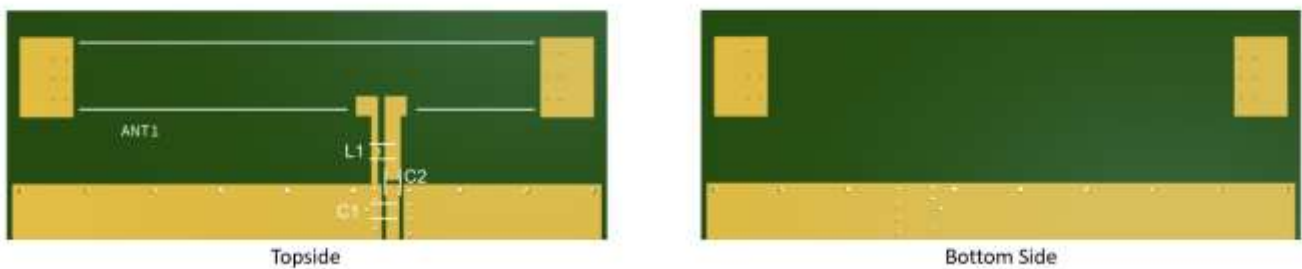

6.4 PCB Keep Out

Below shows the antenna footprint and clearance through ALL layers on the PCB. Only the antenna pads and connections to feed and GND are present within this clearance area (marked RED). The clearance area extends to 5mm from the antenna mechanical pads to the ground area. This clearance area includes the bottom side and ALL internal layers on the PCB.

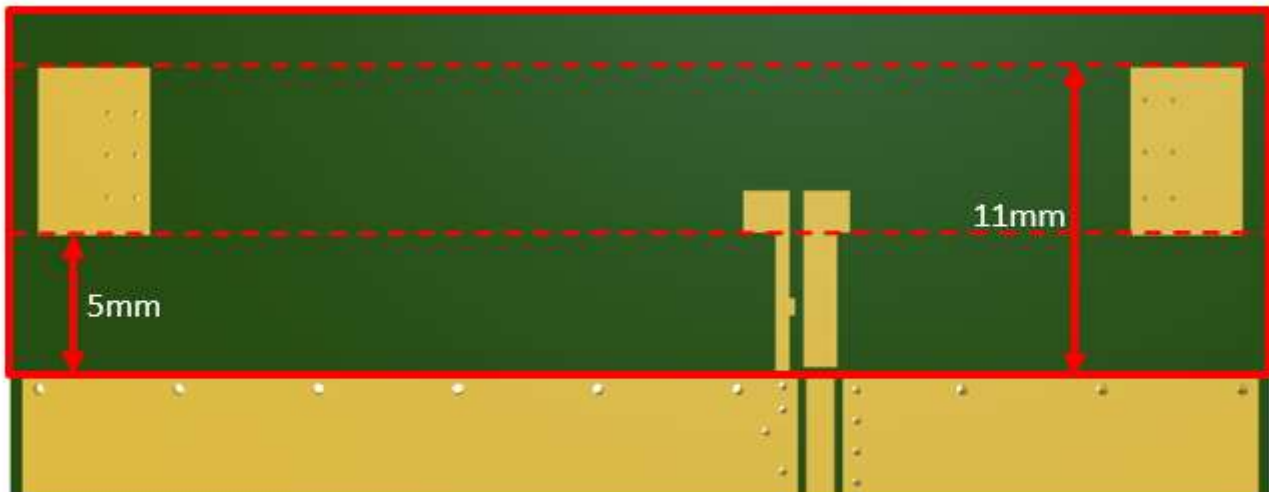

Top Side

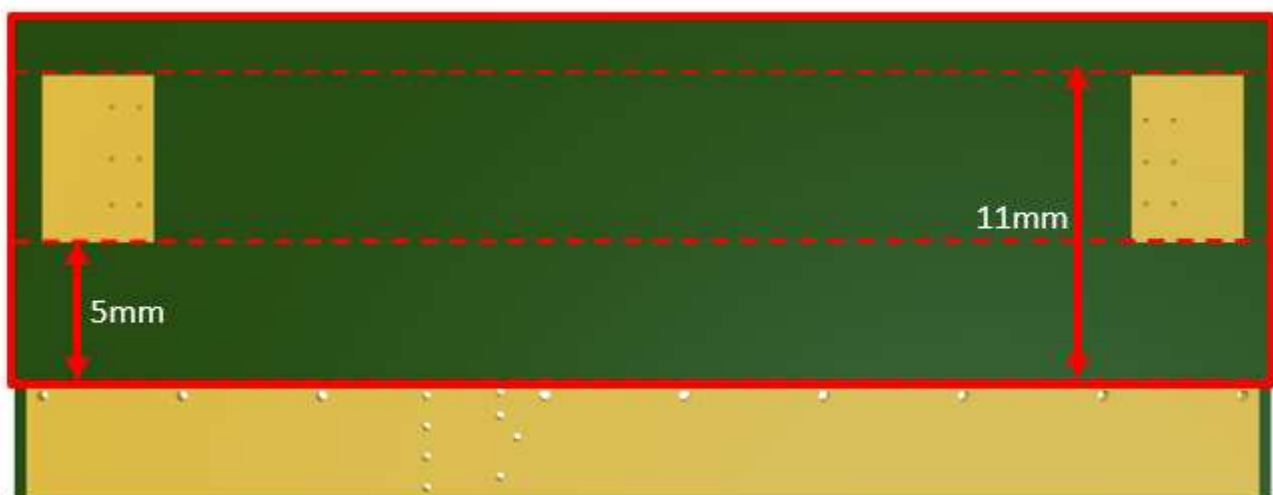

Bottom Side

6.5 Evaluation Board



6.6 Evaluation Board Ground Plane Length



Ground Plane Length
107mm

6.7 Evaluation Board Matching Circuit

A matching component (L1) in parallel with the PA.710.A is required for the antenna to have optimal performance on the evaluation board, located outside of the ground plane in the space specified in the above images. Additional matching components may be necessary for your device, so we recommend incorporating extra component footprints, forming a “pi” network, between the cellular module and the edge of the ground plane.

Designator	Type	Value	Description
L1	Inductor	7.5nH	TDK:MLG1005S
C1	Capacitor	Not Fitted	
C2	Capacitor	3.9pF	Murata:GRM1555 Series

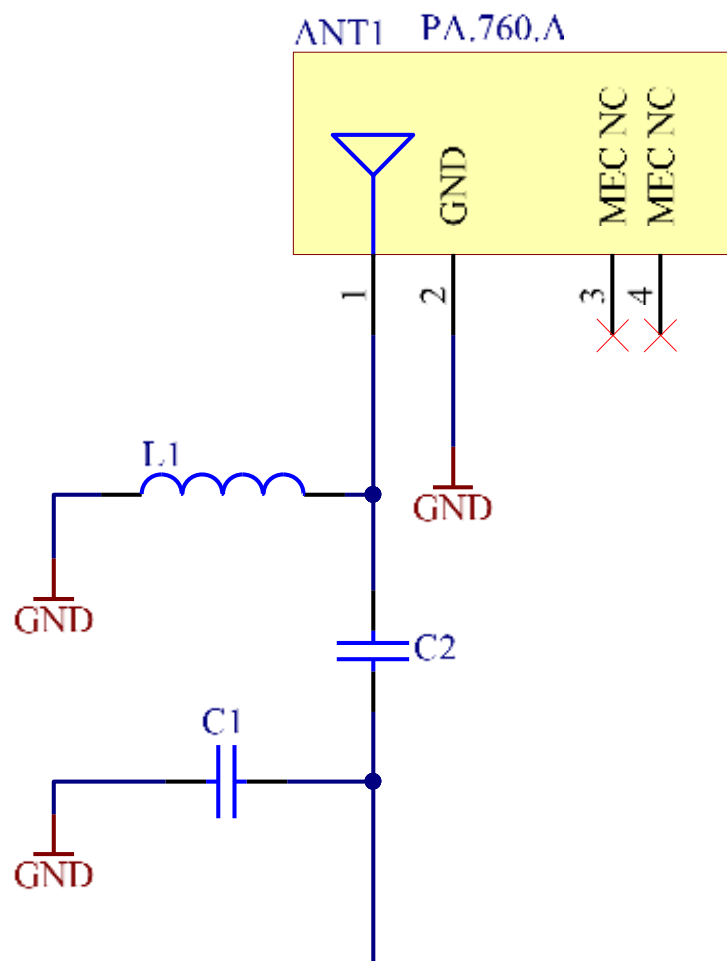

6.8 Footprint Information

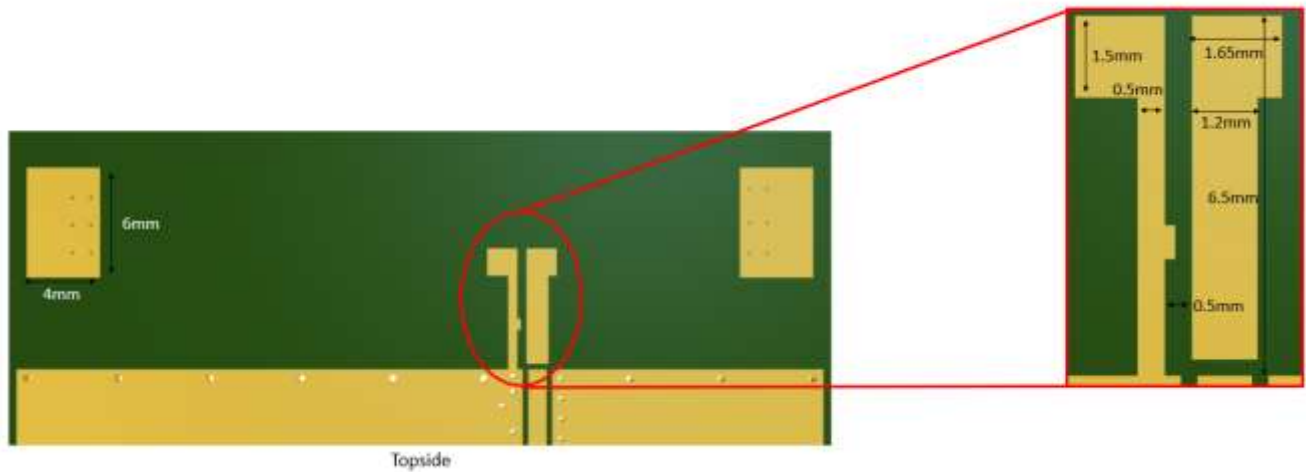

6.9 Vias in Mechanical Pads

Vias are placed in the “no-connect” pads to provide mechanical strength for the pad. These vias are 0.2mm and plated. These vias should be filled with a non-conductive material. Please ensure that the topside surface finish is flat on these pads and the RF Feed and Ground Pad. Vias are covered with soldermask (tenting) on the bottom side.



6.10 PCB Footprint

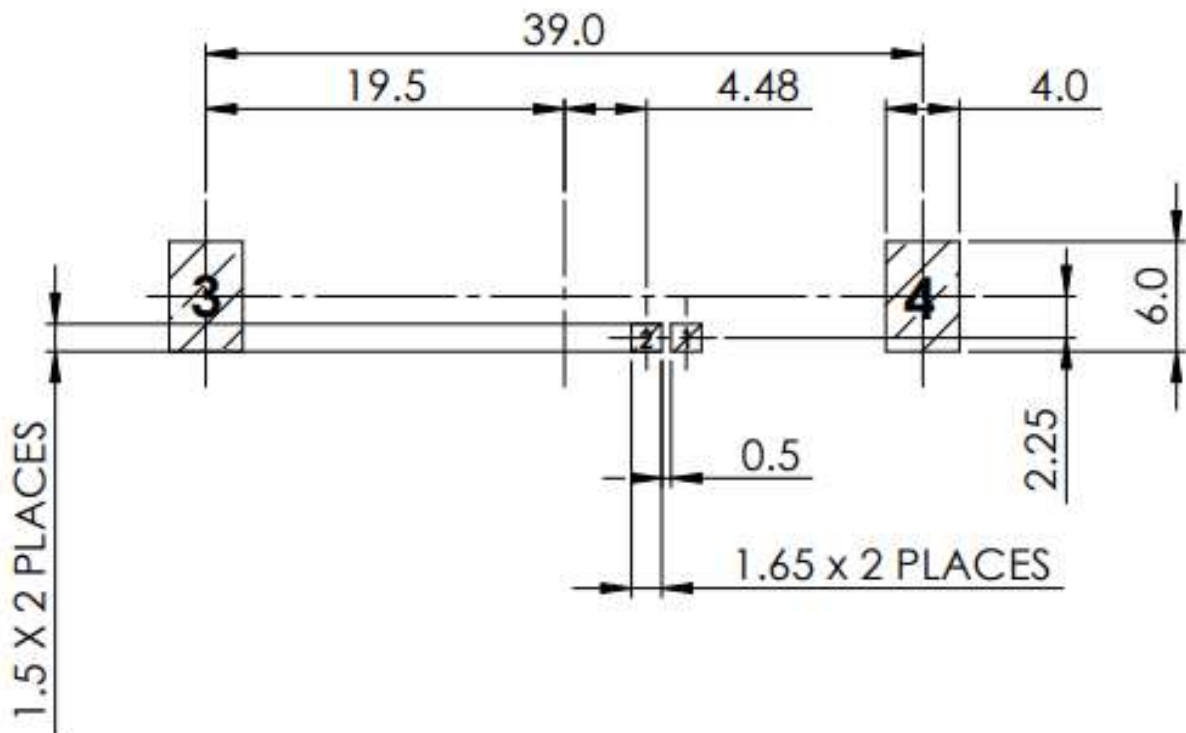

PCB FOOTPRINT

<u>PIN:</u>	<u>DESCRIPTION:</u>
1	Feed (50 ohm)
2	Ground
3,4	NC

7. Packaging

450 pc PA.760.A per Tape & Reel



330mm

330mm

1 reel in small inner box
Dimensions: 350*350*70mm
Weight: 2.4Kg

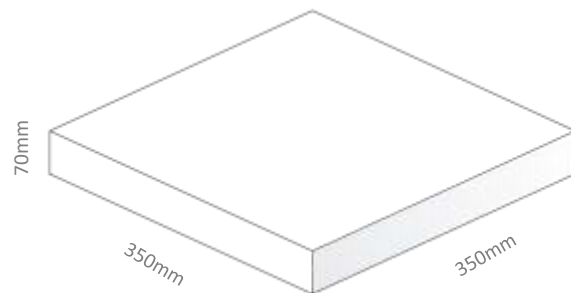

70mm

350mm

350mm

1350 pcs in one carton
Dimensions: 370*360*275mm
Weight: 7.5Kg

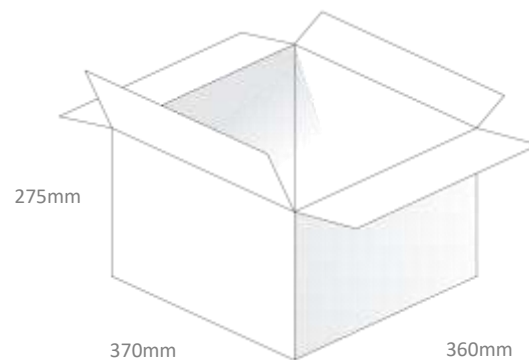

275mm

370mm

360mm

Pallet Dimensions:
1110*1320*1100mm
36 Cartons Per Pallet
9 Cartons Per Layer, 4 Layers

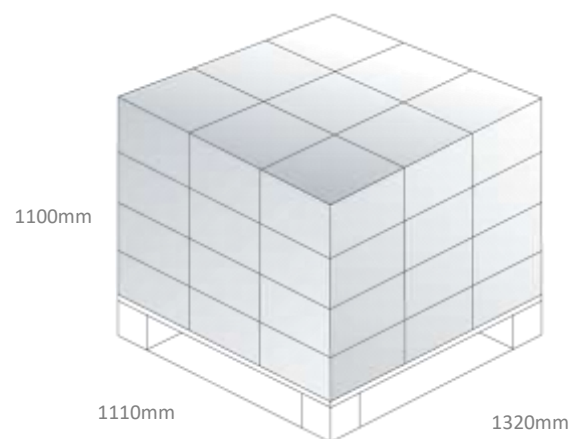

1100mm

1110mm

1320mm

8. Application Note

The PA.760.A has been tested on various size ground planes (180 to 50mm), see the below graphs for performance details.

8.1 Return Loss

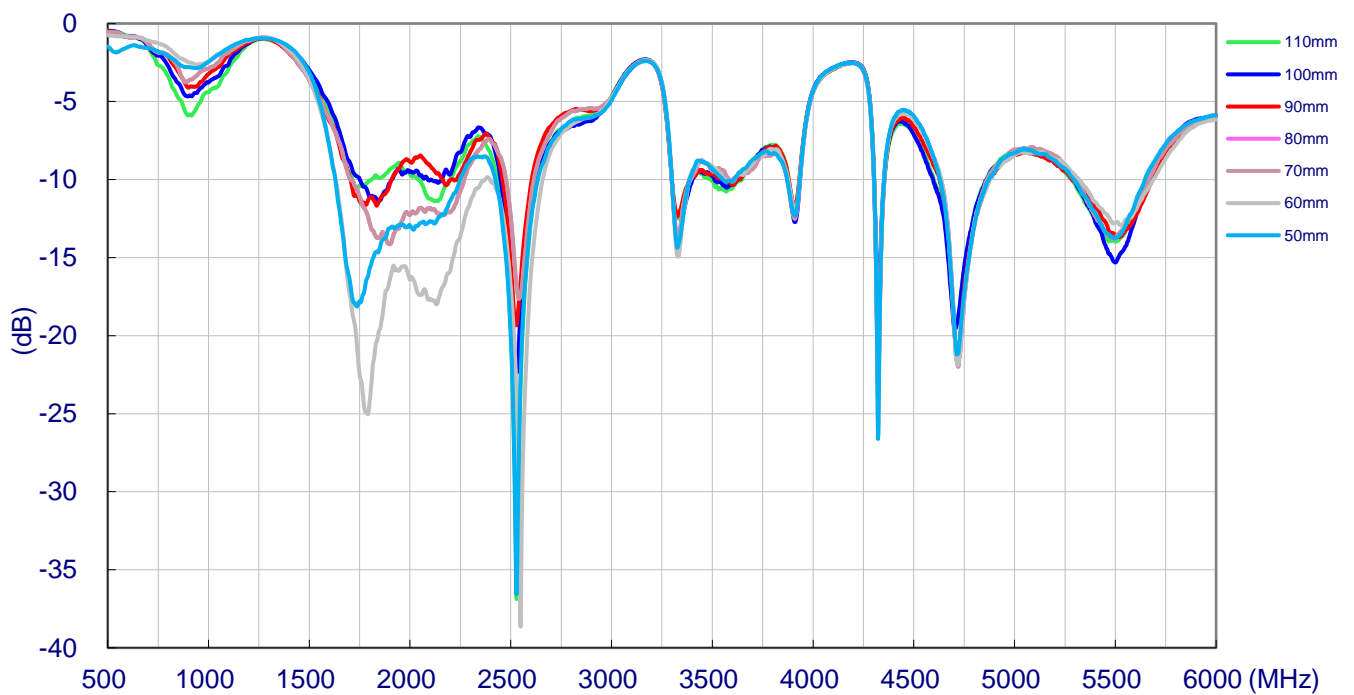
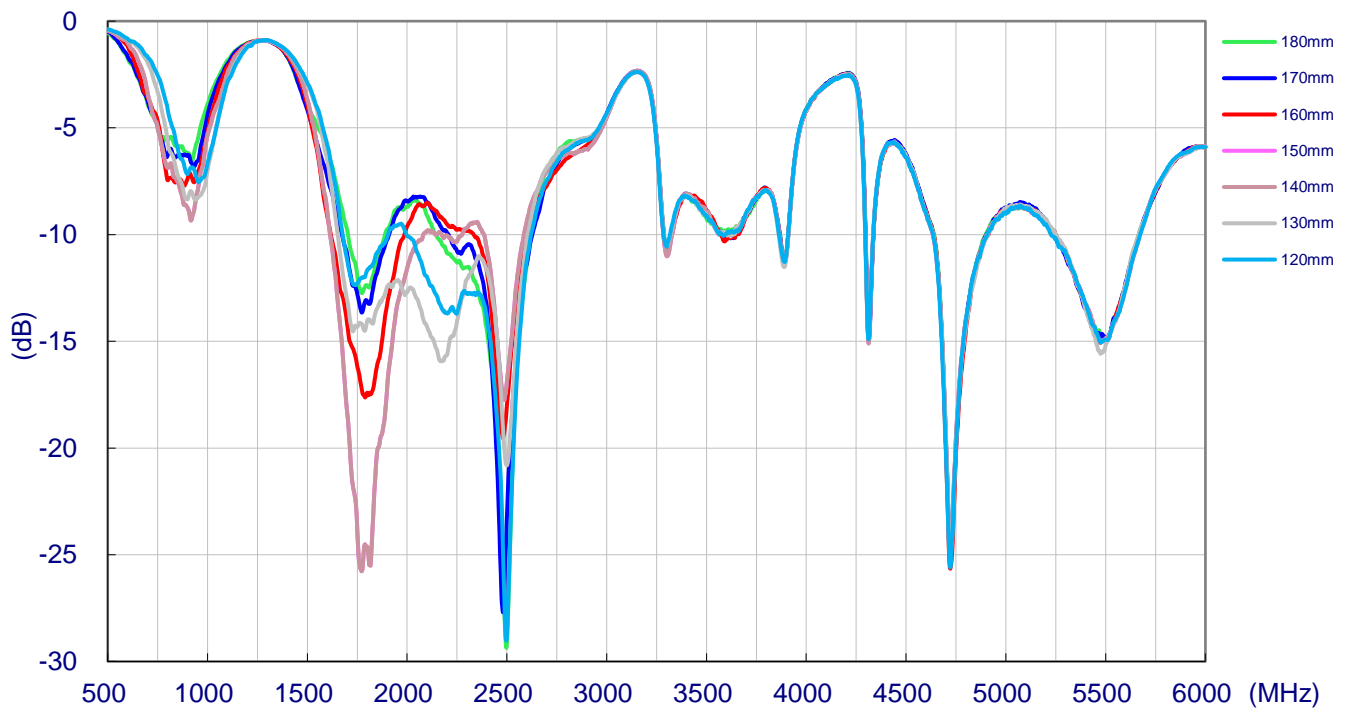

8.2 Efficiency

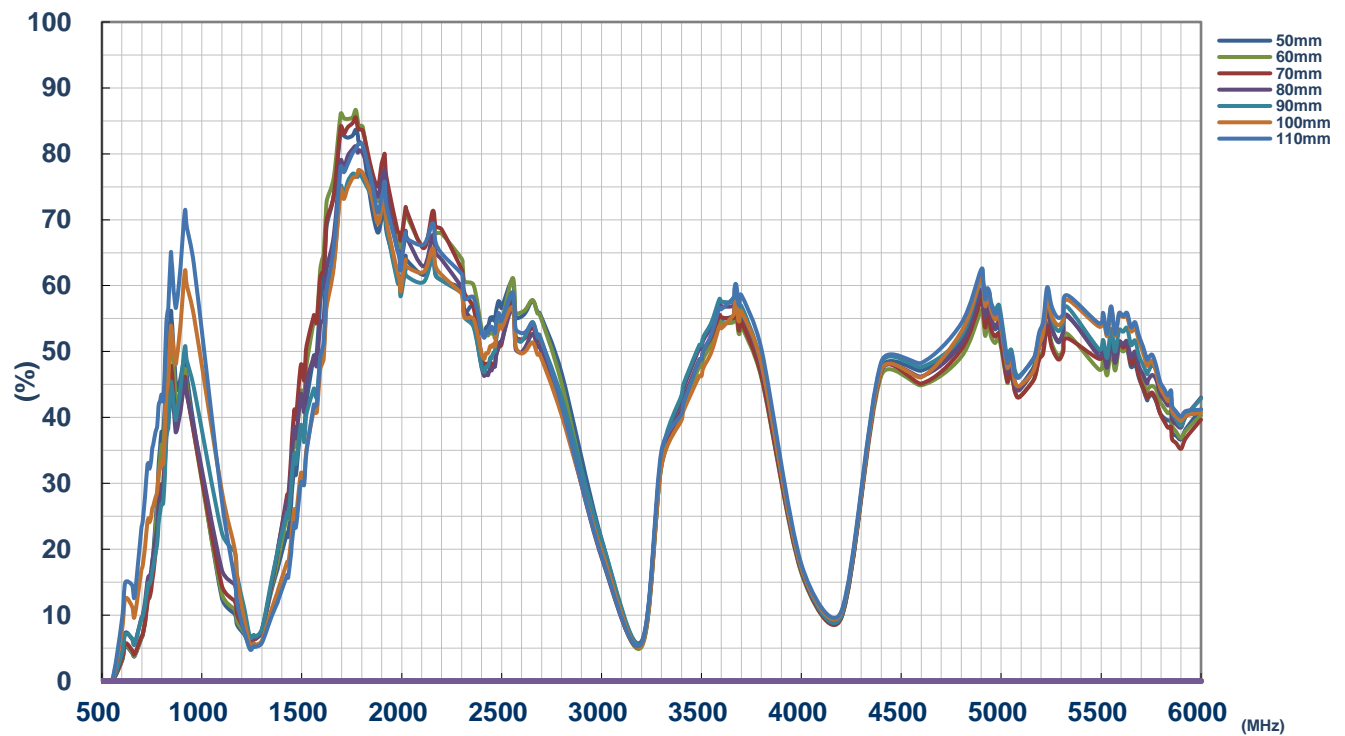
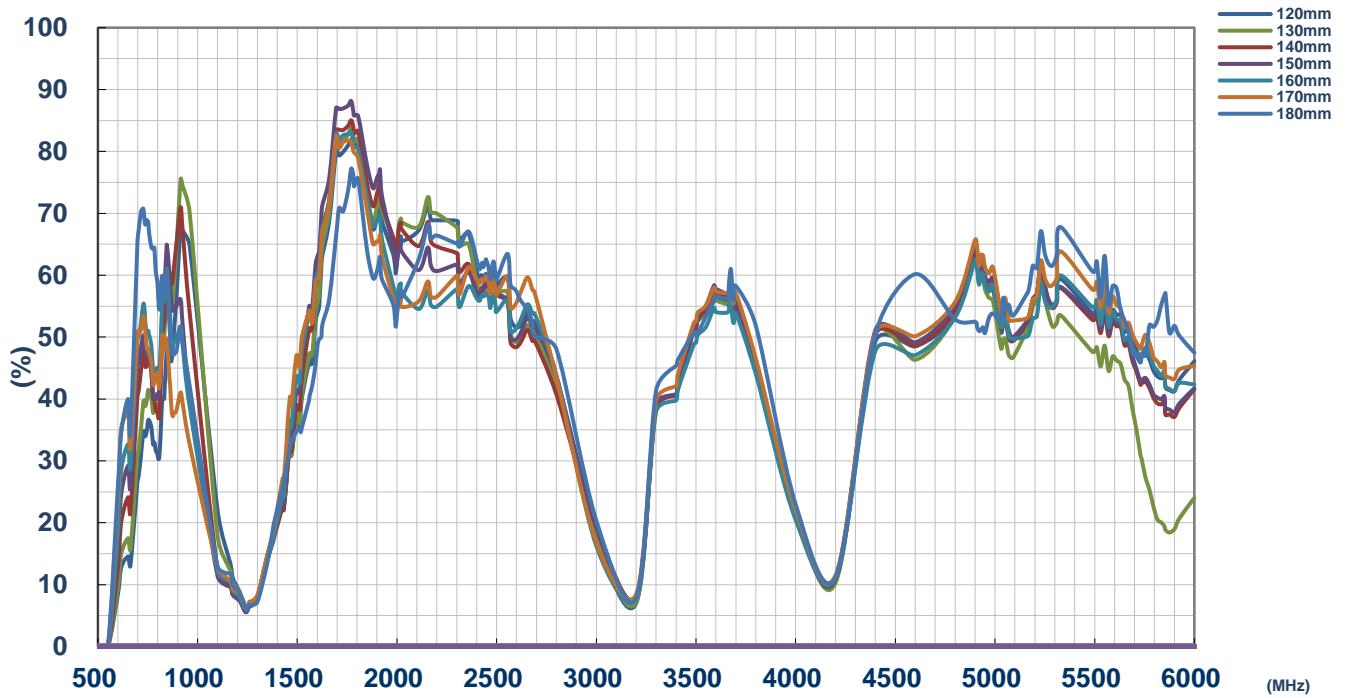

8.3 Average Gain

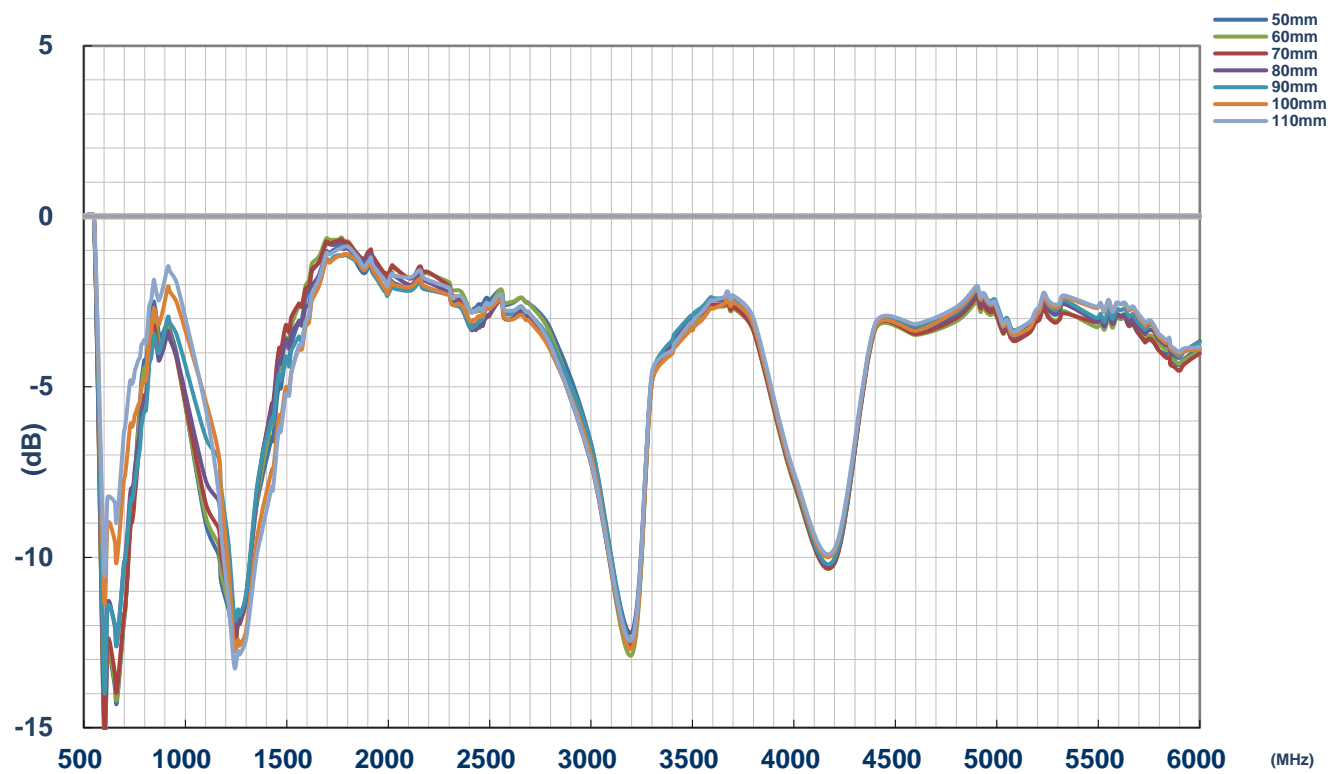
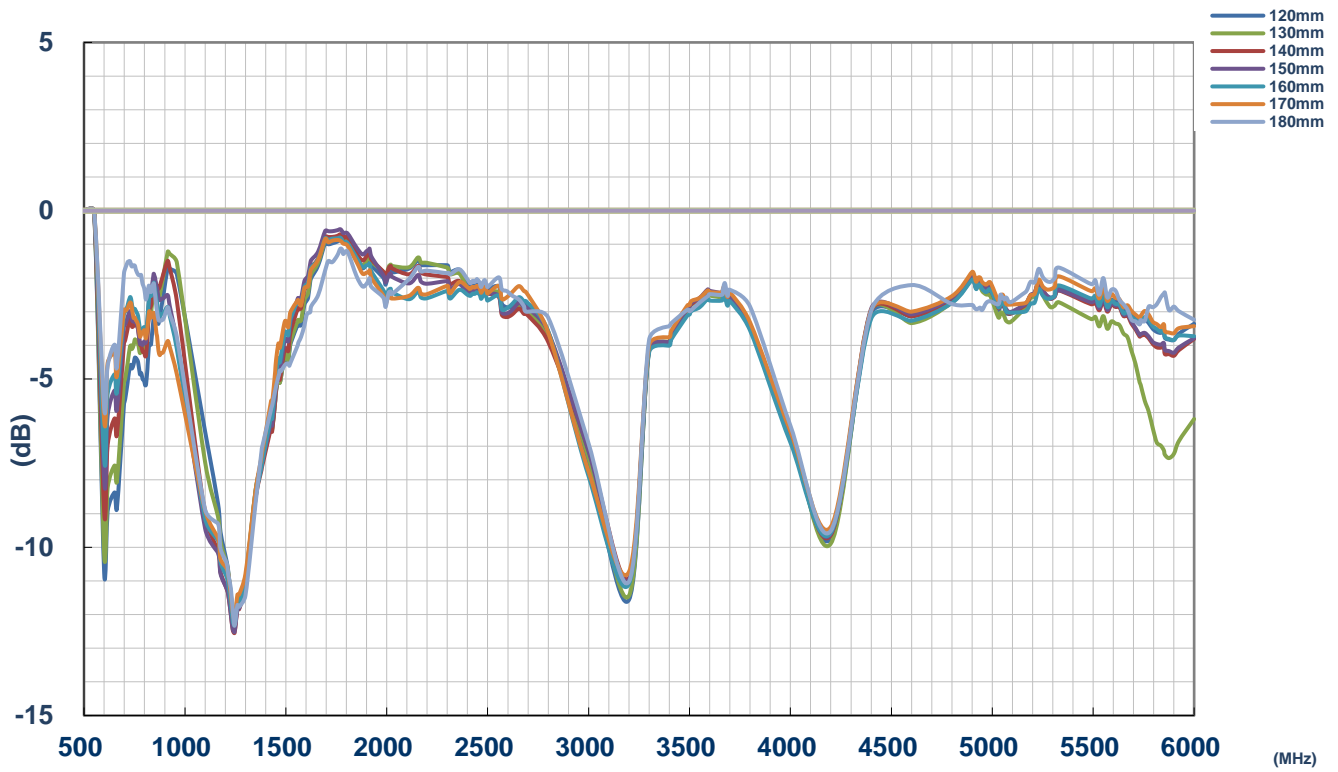

8.4 Peak Gain

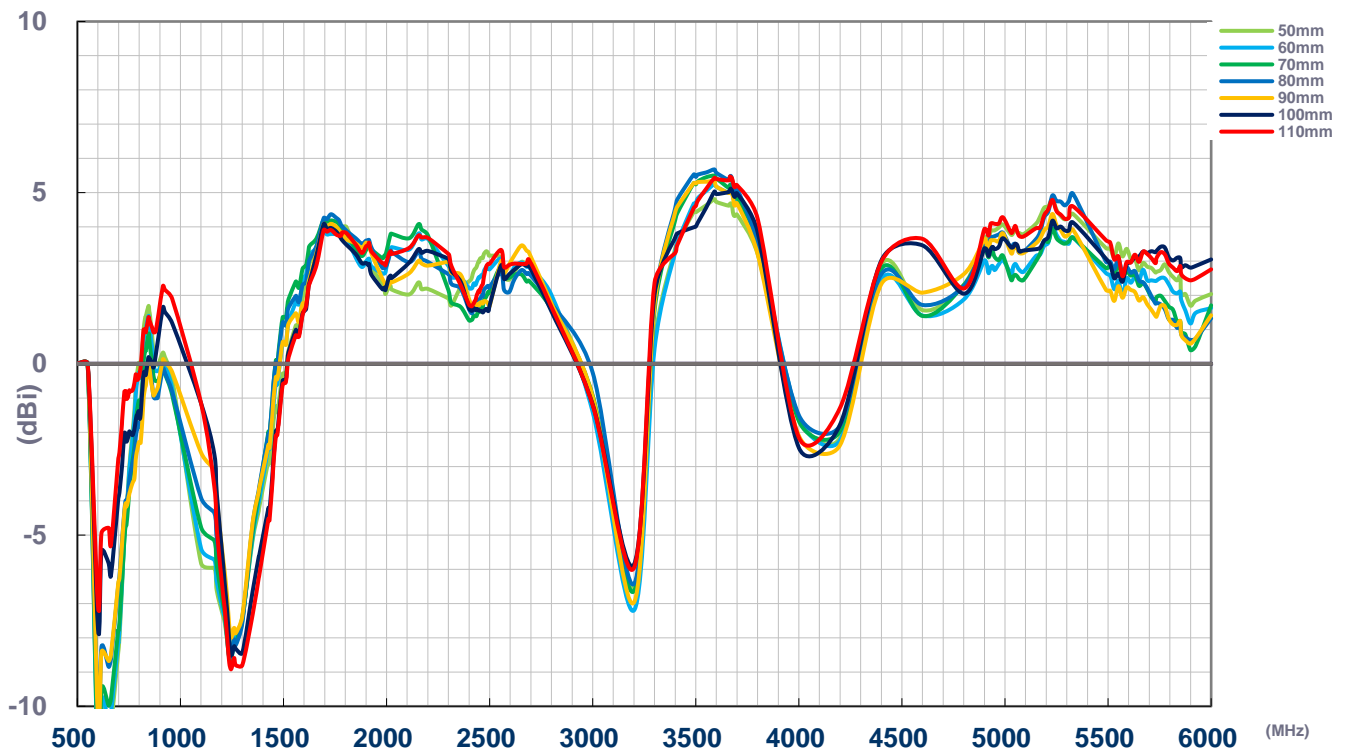
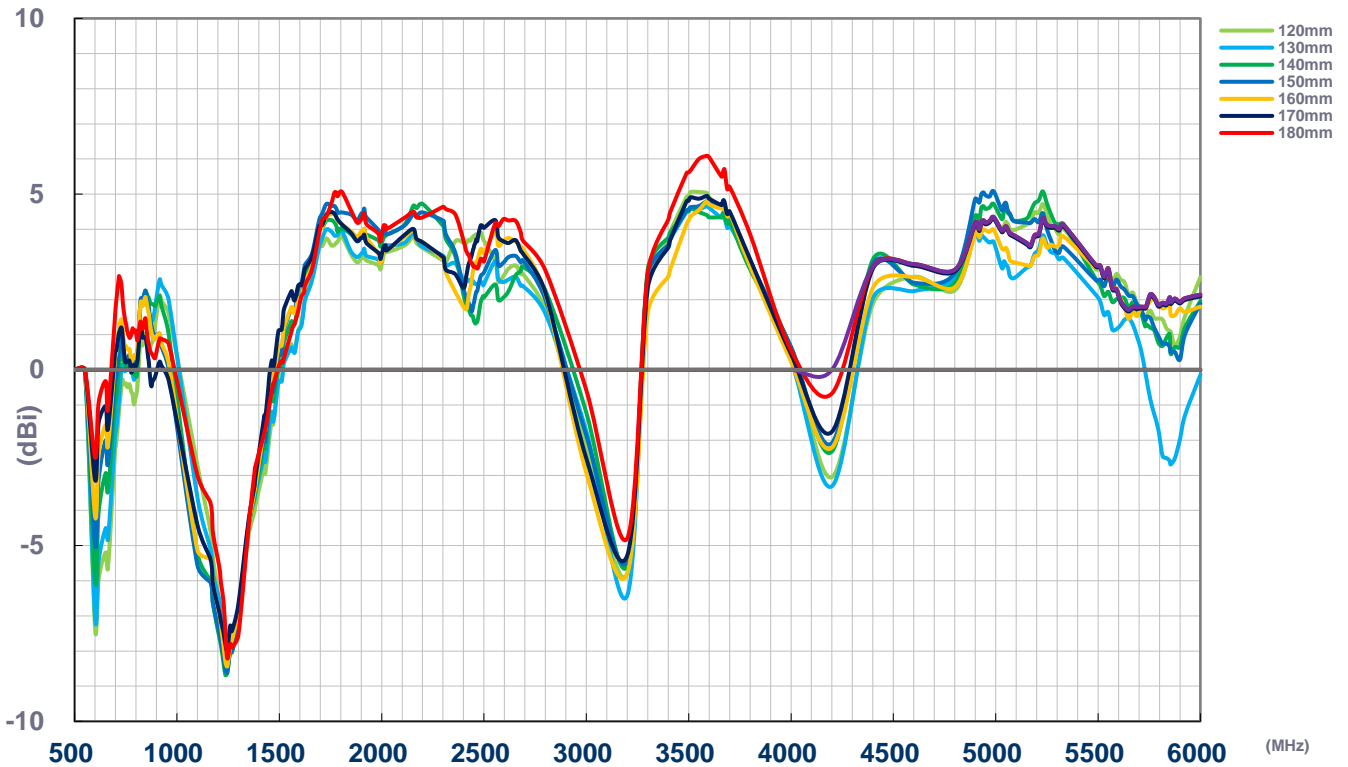

9. Solder Reflow Temperature

PA.760.A can be assembled following either Sn-Pb or Pb-Free assembly processes. The recommended soldering temperatures are as follows:

Phase	Profile Features	Sn-Pb Assembly	Pb-Free Assembly (SnAgCu)
Ramp-Up	Avg. Ramp-Up Rate (T _{smax} to T _P)	3°C/second (max)	3°C/second (max)
Preheat	Temperature Min (T _{smin})	100°	100°
	Temperature Max (T _{smax})	150°	150°
	Time (t _{smin} to t _{smax})	60-120 seconds	60-120 seconds
Reflow	Temperature (T _L)	183°C	217°C
	Total Time Above T _L b(t _L)	60-150 seconds	60-150 seconds
Peak	Temperature (T _P)	235°C	260°C
	Time (t _p)	10-30 seconds	20-40 seconds
Ramp-Down	Rate	6°C/second (max)	6°C/second (max)
Time from 25°C to peak Temperature		6 minutes max	8 minutes max

Temperature profile – (green area) for the assembly process in reflow ovens

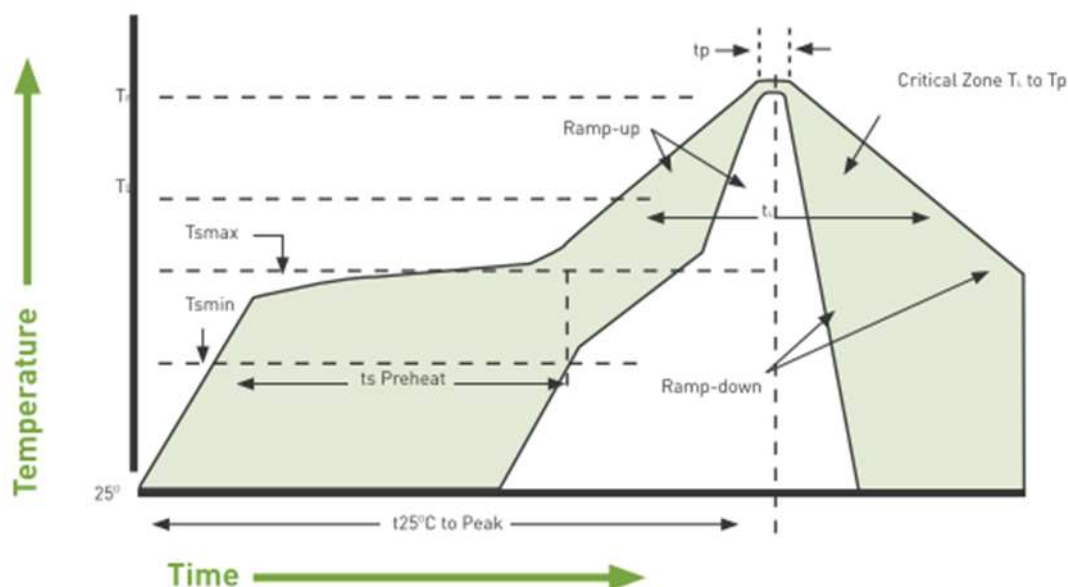

Changelog for the datasheet

SPE-19-8-134 – PA.760.A

Revision: C (Current Version)

Date:	2021-05-06
Changes:	Addition of Antenna Integration Guide
Changes Made by:	Gary West

Previous Revisions

Revision: B

Date:	2020-11-05
Changes:	Specifications table amended
Changes Made by:	Dan Cantwell

Revision: A (Original First Release)

Date:	2019-10-18
Notes:	Initial Release
Author:	Jack Conroy



TAOGLAS®

www.taoglas.com



X-ON Electronics

Largest Supplier of Electrical and Electronic Components

Click to view similar products for [Antennas](#) category:

Click to view products by [Taoglas](#) manufacturer:

Other Similar products are found below :

[GAN30084EU](#) [930-033-R](#) [GW17.07.0250E](#) [1513563-1](#) [EXE902SM](#) [APAMPG-117](#) [MAF94383](#) [W3908B0100](#) [W6102B0100](#) [YE572113-30RSMM](#) [108-00014-50](#) [66089-2406](#) [A09-F8NF-M](#) [A09-F5NF-M](#) [RGFRA1903041A1T](#) [W3593B0100](#) [W3921B0100](#) [SIMNA-868](#) [SIMNA-915](#) [SIMNA-433](#) [W1044](#) [W1049B090](#) [A75-001](#) [WTL2449CQ1-FRSMM](#) [CPL9C](#) [EXB148BN](#) [0600-00060](#) [TRA9020S3PBN-001](#) [GD5W-28P-NF](#) [MA9-7N](#) [GD53-25](#) [GD5W-21P-NF](#) [C37](#) [MAF94051](#) [MA9-5N](#) [EXD420PL](#) [B1322NR](#) [QWFTB120](#) [MAF94271](#) [MAF94300](#) [GPSMB301](#) [FG4403](#) [AO-AGSM-OM54](#) [5200232](#) [MIKROE-2349](#) [WCM.01.0111](#) [MIKROE-2393](#) [MIKROE-2352](#) [MIKROE-2350](#) [MAF94153](#)