



TAOGLAS®



Datasheet

Taoglas Reach Series - PCS.66.A

Description:

Reach Low Profile Wideband 5G/4G SMD Antenna

Features:

Patent Pending Innovative Design

High Efficiency Wideband Antenna, Covering 600 to 6000 MHz

Supporting 5G FR1 Bands

600 MHz 5G/4G Band 71 Support

Backwards Compatible with all 3G/2G applications

Surface Mount Distribution – Supplied on Tape & Reel

Dimensions: 32 x 25 x 1.6 mm

RoHS & REACH Compliant

1. Introduction	3
2. Specifications	5
3. Antenna Characteristics	6
4. 2D Radiation Patterns	9
5. 3D Radiation Patterns	12
6. Mechanical Drawing	17
7. Layout Dimensions	18
8. EVB Dimensions	19
9. Matching Circuit	20
10. Packaging	21
<hr/>	
Changelog	22

Taoglas makes no warranties based on the accuracy or completeness of the contents of this document and reserves the right to make changes to specifications and product descriptions at any time without notice. Taoglas reserves all rights to this document and the information contained herein. Reproduction, use or disclosure to third parties without express permission is strictly prohibited.



1. Introduction

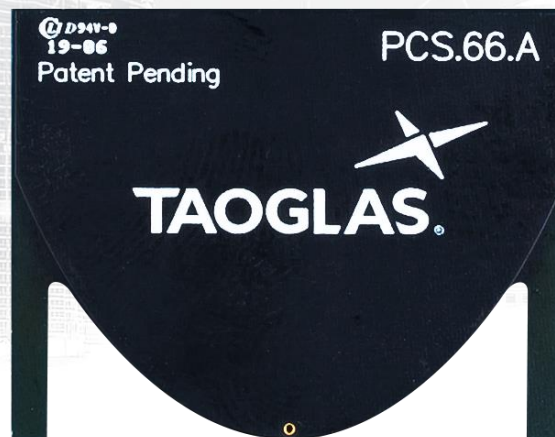

The Taoglas Reach series, are a revolutionary, low profile, small footprint, range of patent pending SMD mount PCB wide-band antennas. The PCS.66.A has been designed to cover all 5G bands, including all sub-6GHz deployments across the 600MHz to 6000MHz spectrum on a very small footprint of just 32 x 25mm. It also covers 3G and 2G bands to allow for fall-back when 5G/4G is not available.

The patent pending design uses printed circuit board material and innovative design techniques to deliver the highest efficiencies at all bands when mounted on the device's main PCB. The PCS.66.A is suitable for lower cost 5G/4G applications, especially IoT projects requiring wide bandwidth and comes supplied on tape and reel to allow it be mounted via 'pick & place' onto the PCB.

If tuning is required, it can also be tuned specifically depending on device environment. If PCB space is an issue, the Reach PCS.86, covering 791 – 6000MHz, could be an option with an even smaller footprint of just 32 x 16mm. Contact your local Taoglas customer support team for advice on integrating the Reach into your device.

1.1 Key Advantages

1. Highest efficiency in small footprint

A comparative antenna to the Reach, for example, metal/ceramic/FPC, would have much-reduced efficiency in this configuration due to their high substrate loss at high frequencies. Very high efficiency antennas are critical to 4G and 5G devices ability to deliver the stated data-speed rates of systems such as 5G and 4G.

2. Low profile

Many antennas require a large keep-out area in addition to the mechanical size to work correctly, which limits the usable PCB space. The Reach requires only .3 mm of additional keep-out, allowing board designers to maximize their PCB space.

3. Adaptable

The high radiation efficiency of the Reach over its entire operating bandwidth means that the total efficiency is only limited by the impedance mismatch loss. As a result, this antenna can be optimized via a matching network to the specific bands needed for any application. Efficiencies as high as 90% have been measured when the return loss is very high (-15 dB or more).

4. More resistant to detuning compared to other antenna integrations

If tuning is required it can be tuned for the device environment using a matching circuit, or other techniques on the main PCB itself. There is no need for new tooling, thereby saving money if customization is required.

5. Surface Mount Distribution (SMD)

Direct mount, 'on-board' antennas save on labor, cable and connector costs, leads to higher integration yield rates and reduces losses in transmission.

6. Minimum Transmission and Reception Losses

These are kept to an absolute minimum resulting in much improved OTA (over the air), i.e. TRP (Total Radiated Power) / TIS (Total Isotropic Radiation), device performance compared to similar efficiency cable and connector antenna solutions. This means it is an ideal antenna to be used for devices that need to pass for example USA carrier network approvals.

2. Specifications

Electrical								
Standard	5G NR Band 71/LTE/GSM/CDMA	5G NR Band 74,75,76	LTE/GSM/HSPA/CDMA	UMTS/HSPA	Wi-Fi 2400	LTE 2600	5G NR Band 77,78,79	Wi-Fi 5800
Operation Frequency (MHz)	617-960	1427-1518	1710-1990	1920-2170	2400-2500	2500-2700	3300-5000	5150-5850
Peak Gain	1.3 dBi	2.5 dBi	3.2 dBi	3.5 dBi	3.5 dBi	5.7 dBi	5.5 dBi	3.5 dBi
Average Gain	-2.6 dB	-3.3 dB	-1.6 dB	-1.7 dB	-2 dB	-1.5 dB	-1 dB	-3.4 dB
Efficiency	55%	46%	69%	68%	63%	70%	80%	45%
VSWR	<3.0:1							
Impedance	50Ω							
Polarization	Linear							
Radiation Properties	Omni-directional							
Max Input Power	5 W							

The Reach PCS.66.A antenna performance was measured on a 107x32 ground plane

Mechanical	
Dimensions	32mm x 25mm x 1.6mm
Material	PCB
Termination	Solder Pad
EVB Connector	SMA-Female

Environmental	
Operation Temperature	-40°C to 85°C
Storage Temperature	-40°C to 105°C
Relative Humidity	Non-condensing 65°C 95% RH
RoHs & REACH Compliant	Yes
Moisture Sensitivity	Level 3

3. Antenna Characteristics

3.1 Test Setup

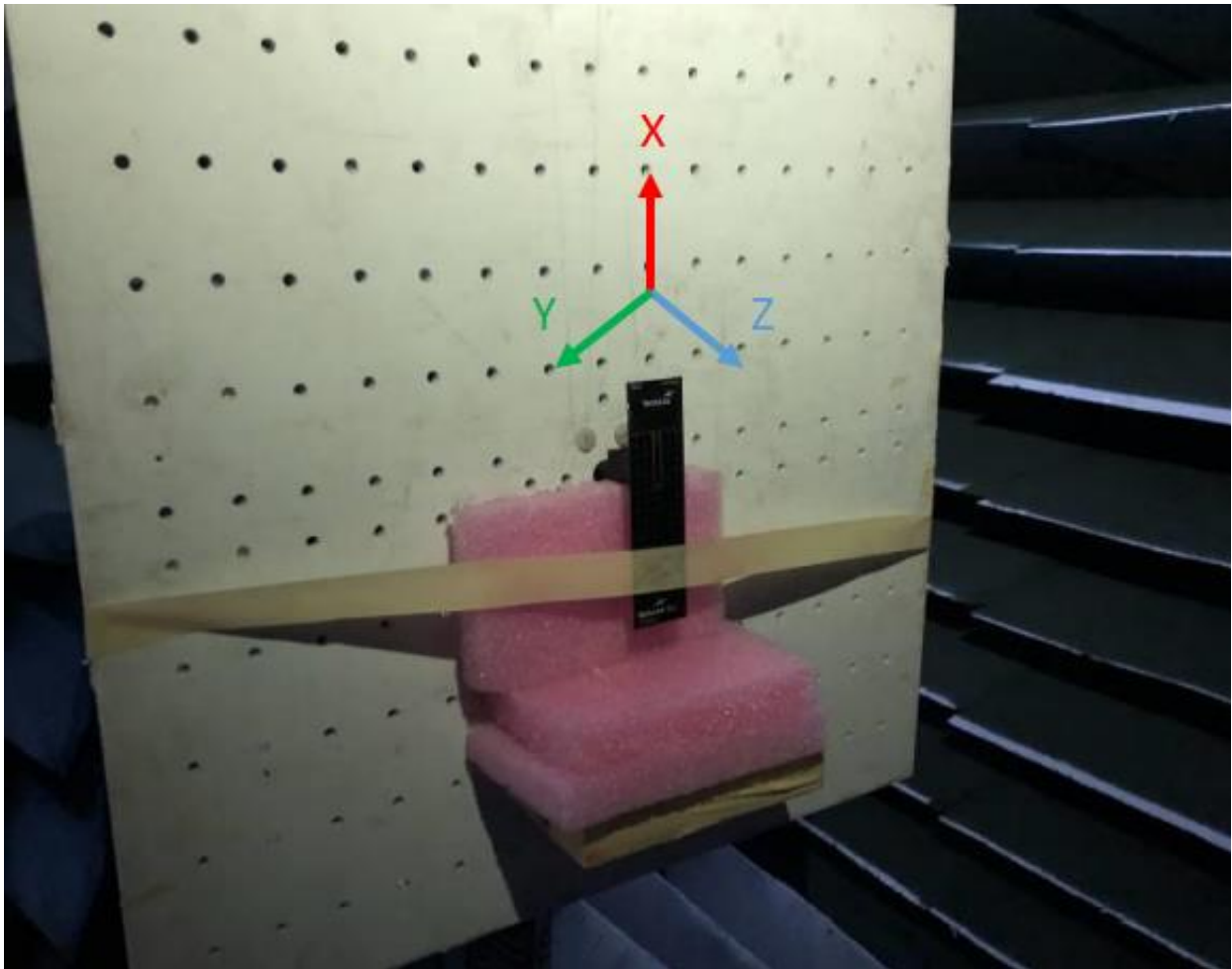

On Evaluation Board

3.2 Return Loss

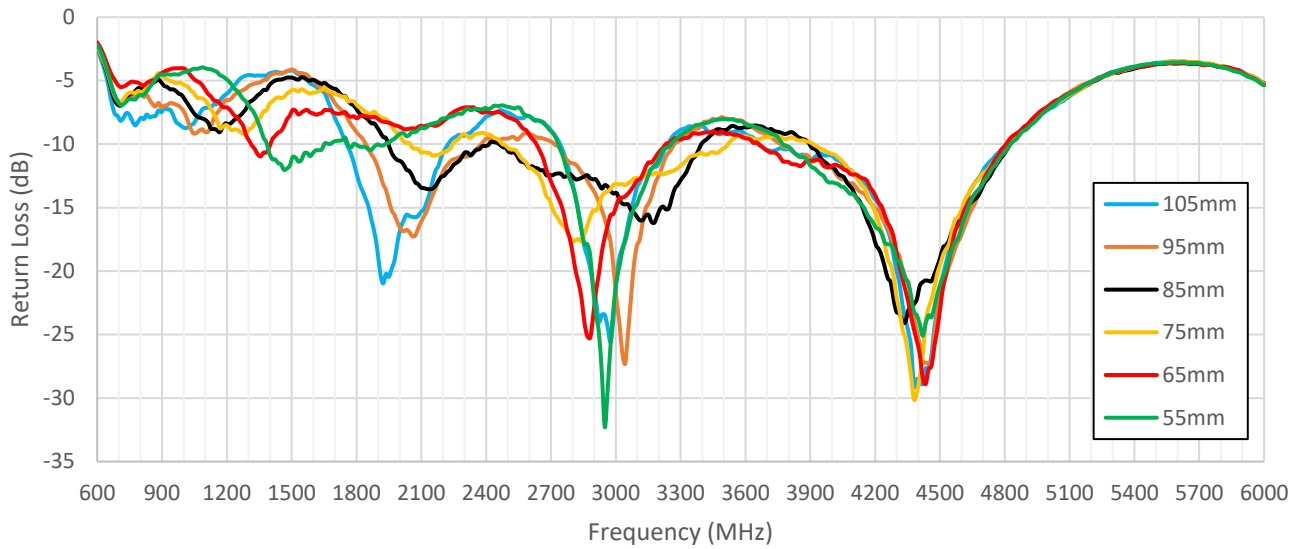

3.3 VSWR

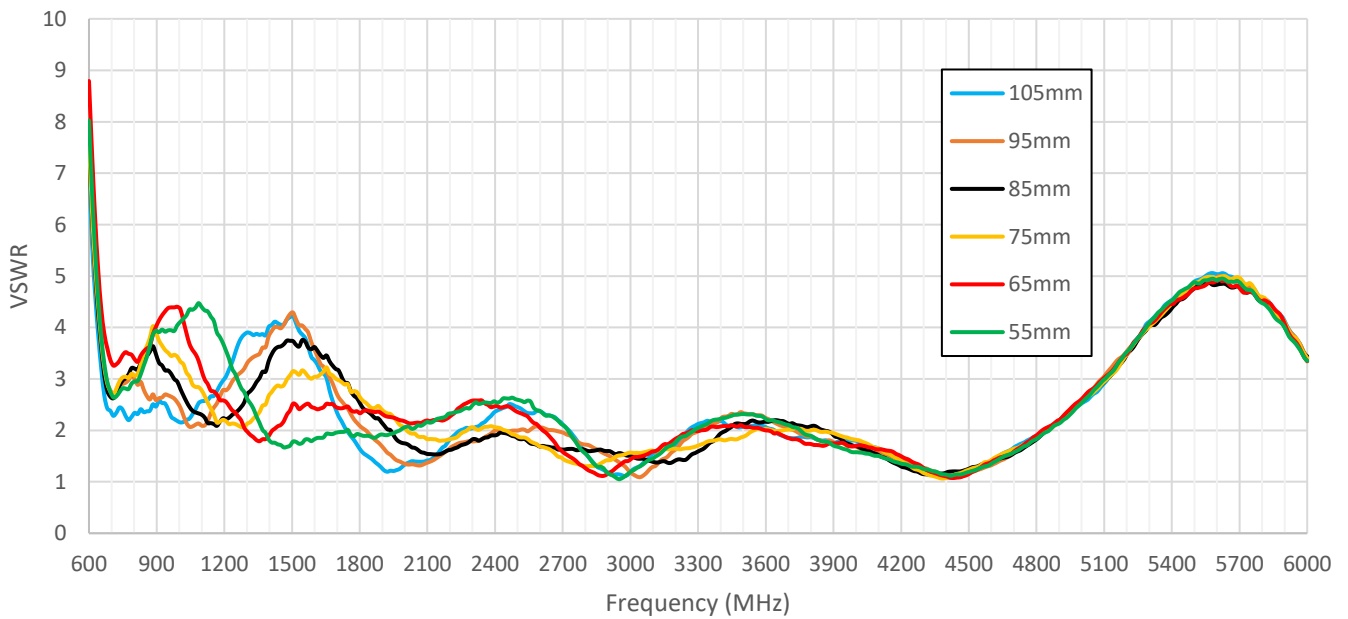

3.4 Efficiency

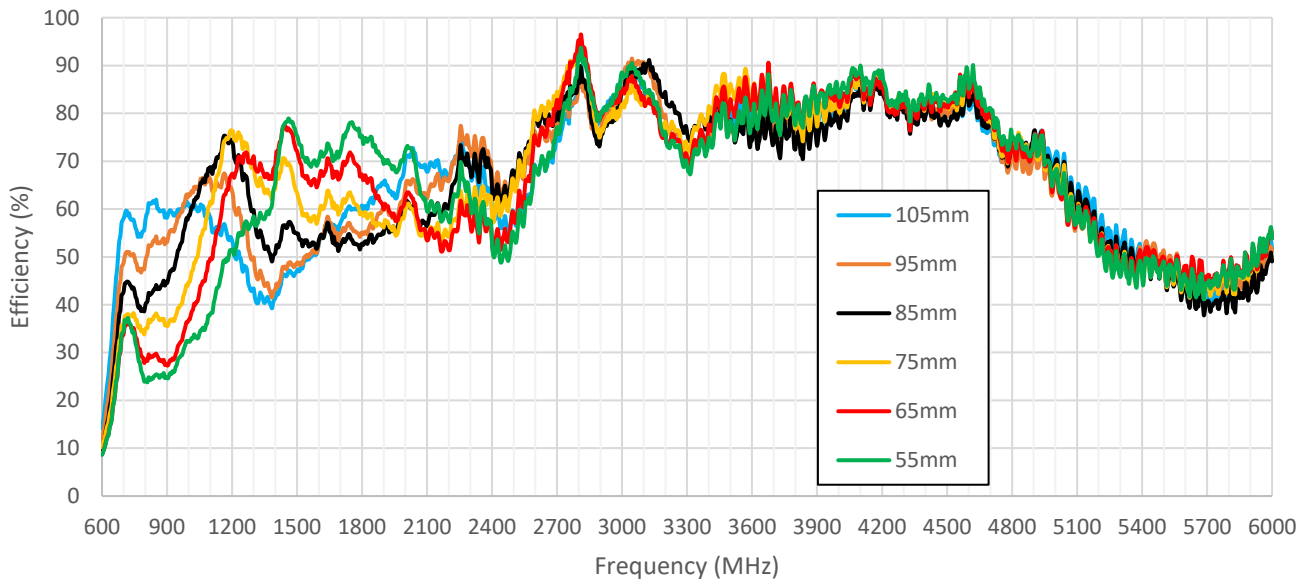

3.5 Peak Gain

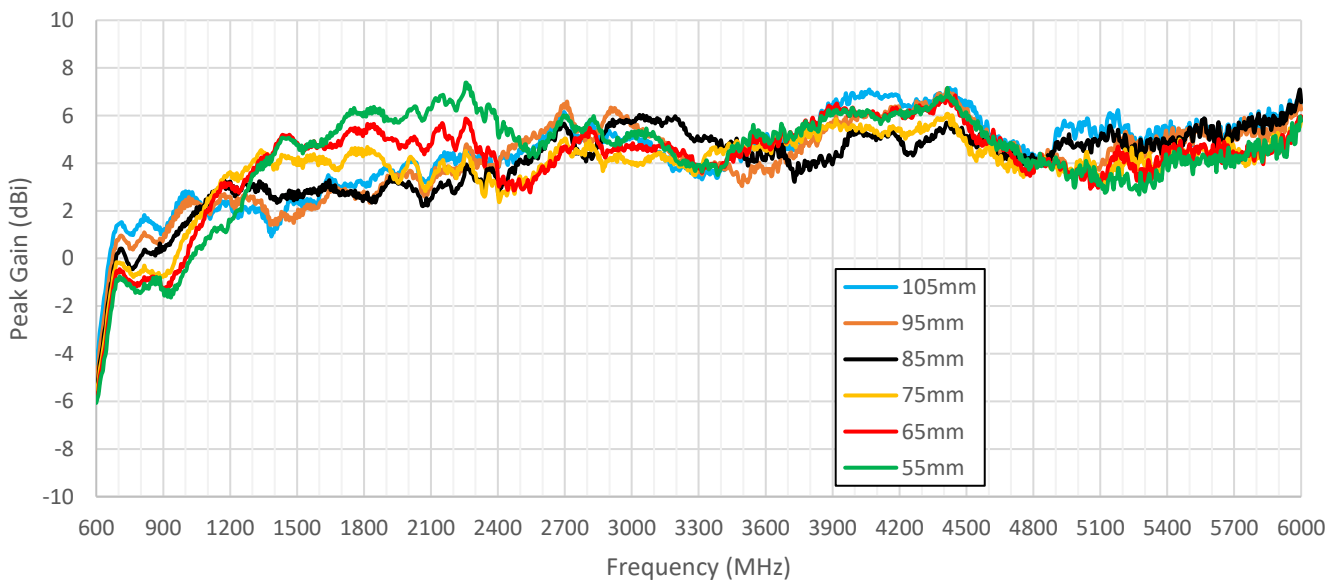

3.6 Average Gain

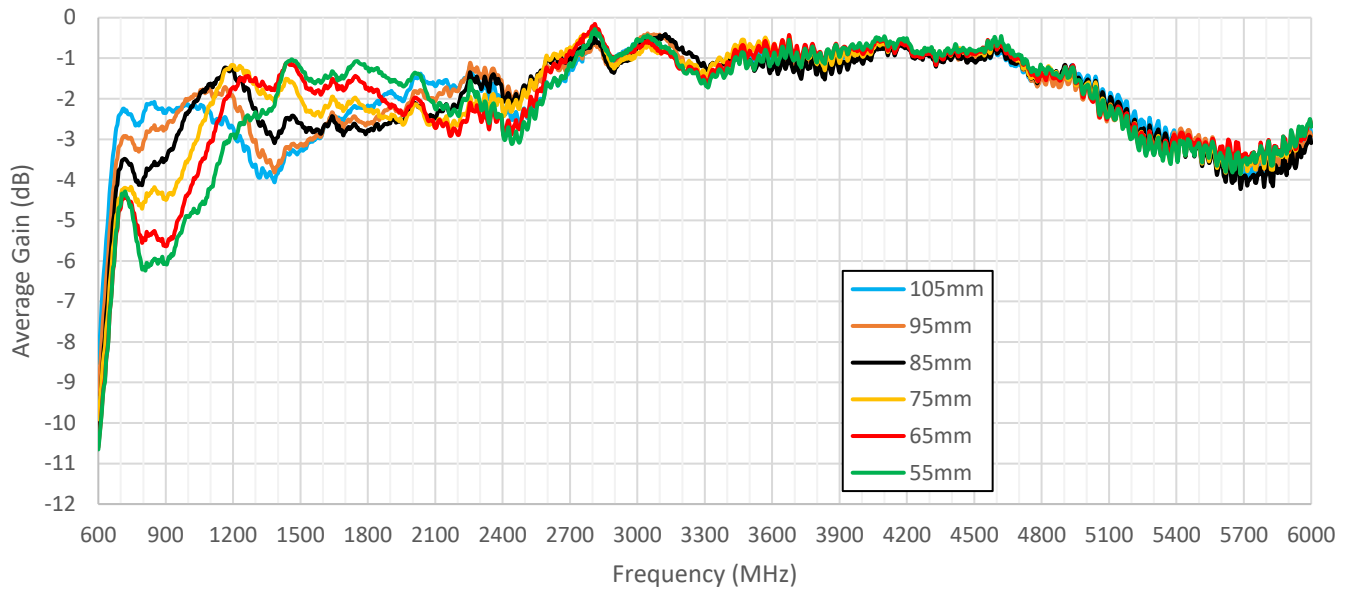

4. 2D Radiation Patterns (Measured on 130*32mm EVB)

XY Plane

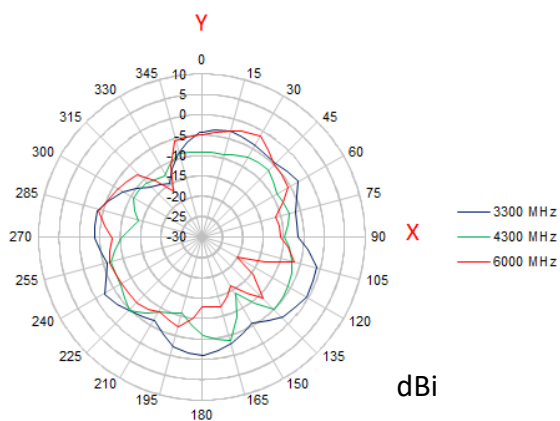
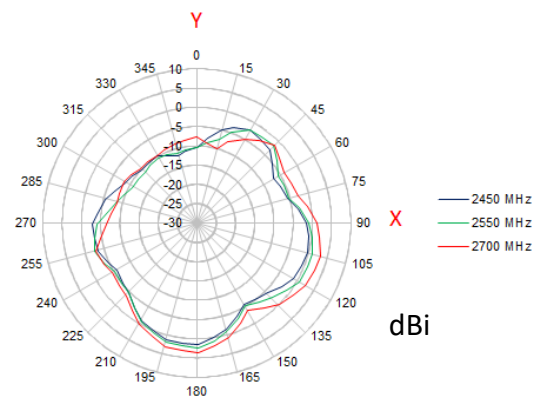
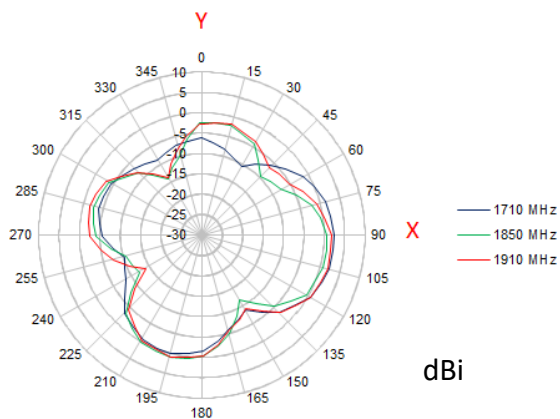
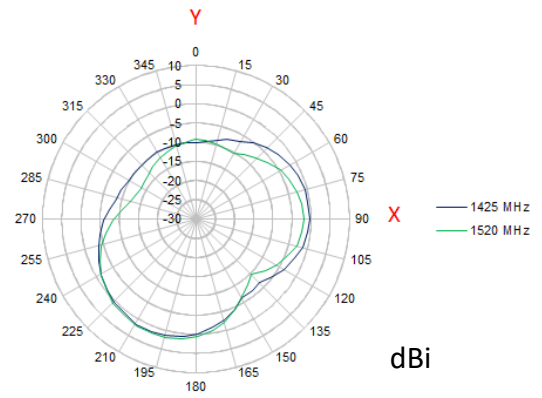
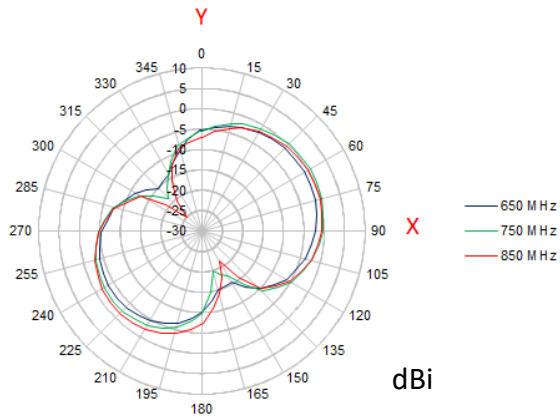

YZ Plane

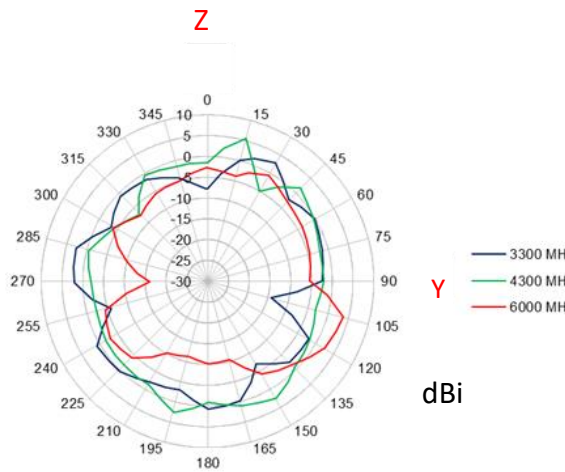
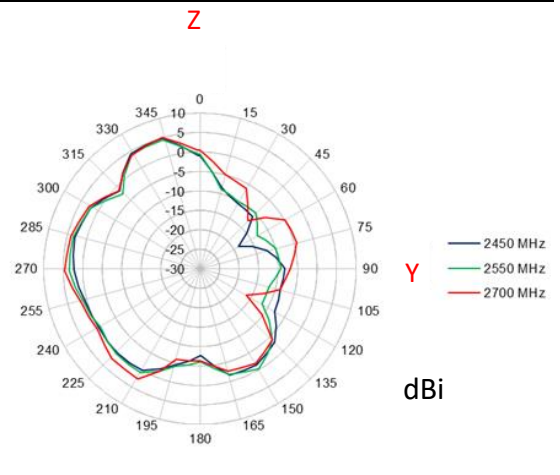
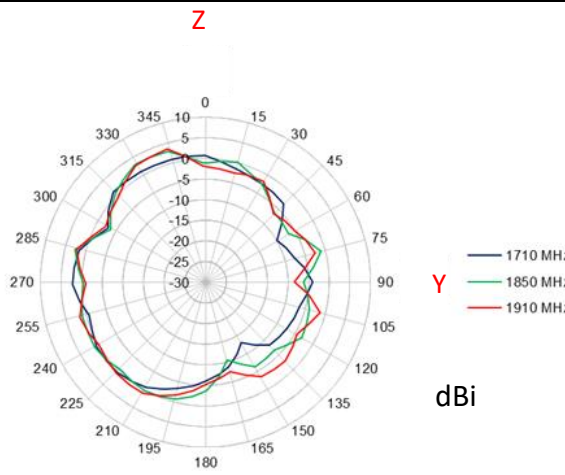
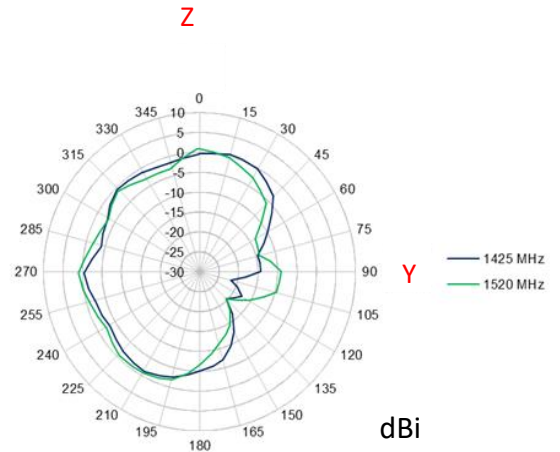
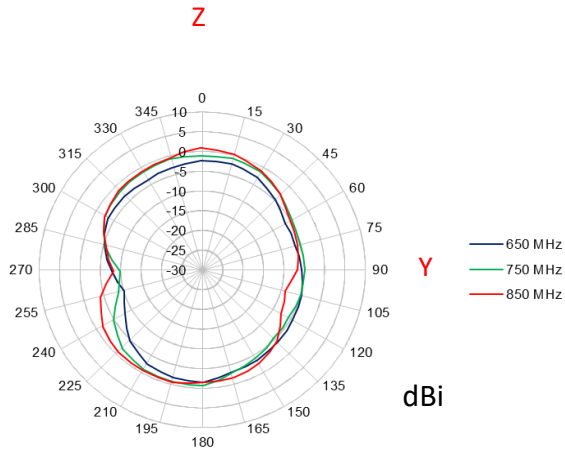

XZ Plane

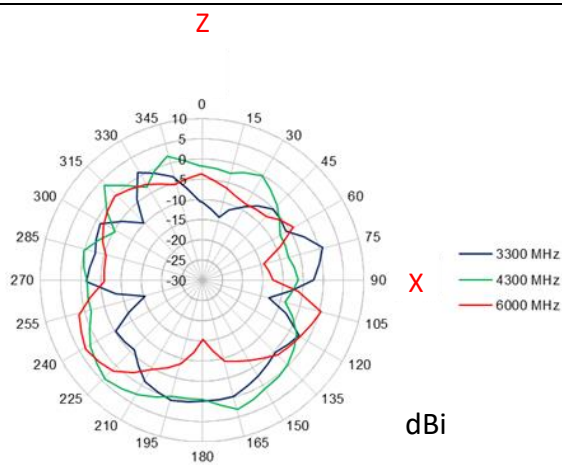
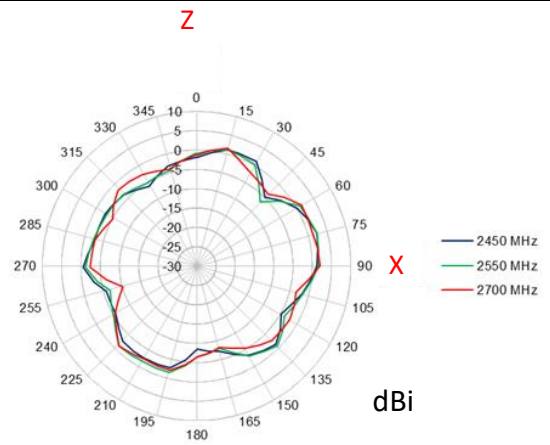
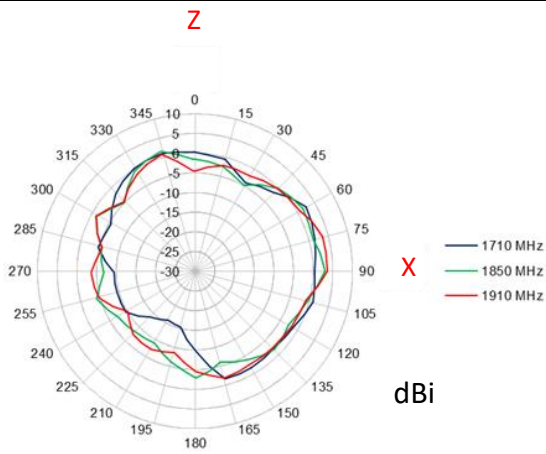
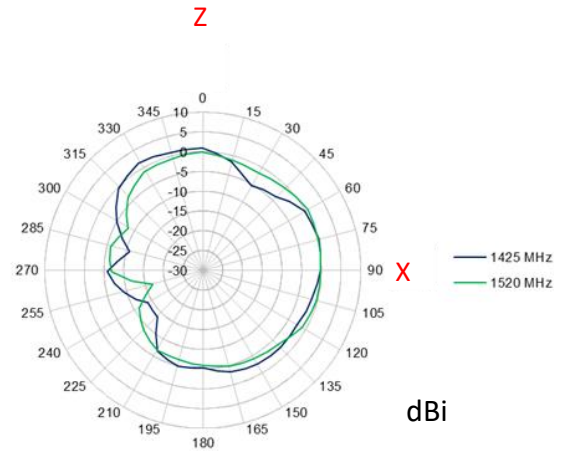
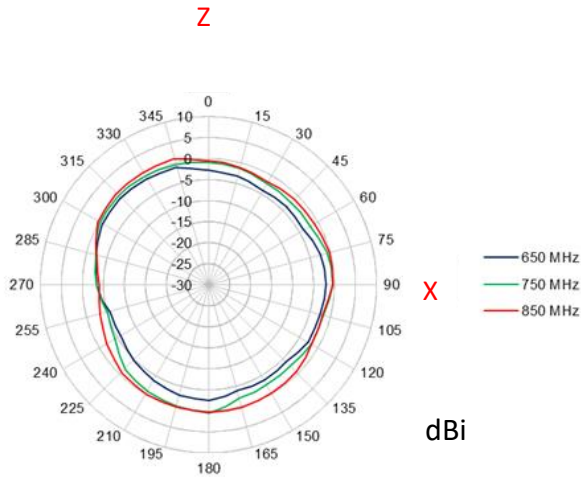

5. 3D Radiation Patterns

5.1 132*32mm EVB

650 MHz

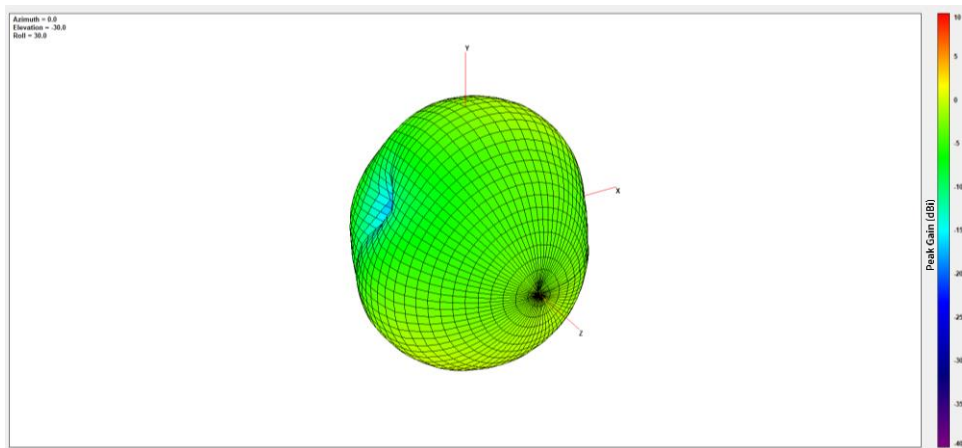

750 MHz

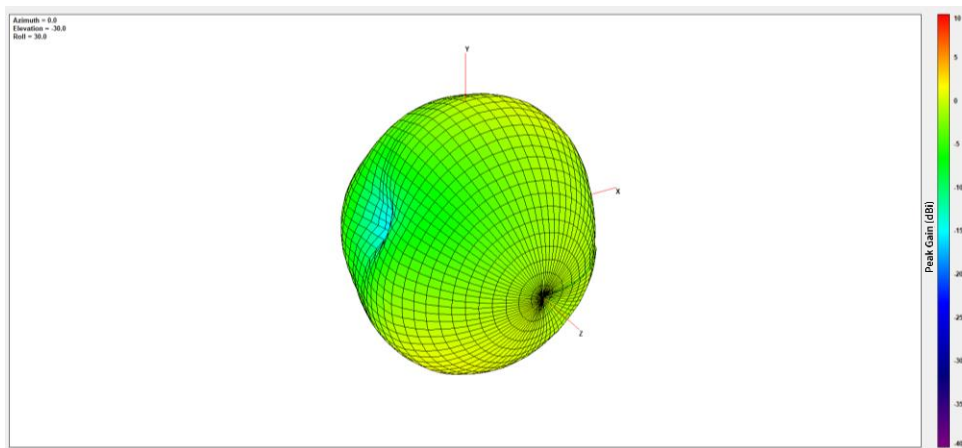

850 MHz

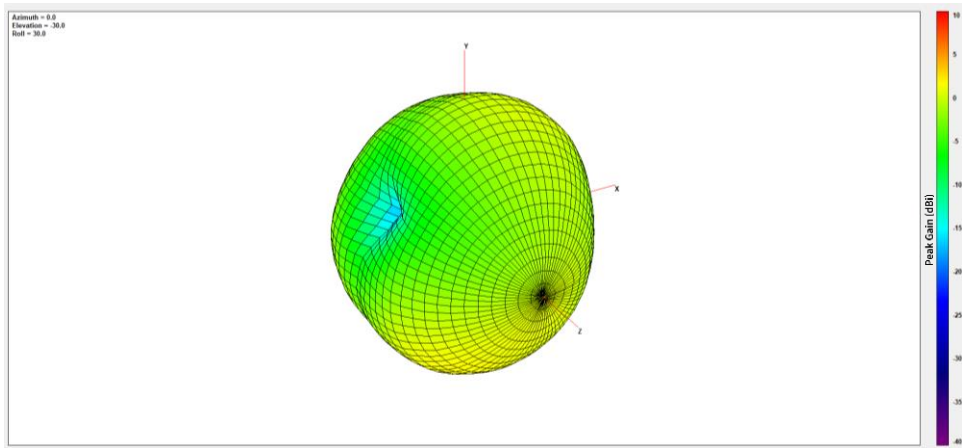

1425 MHz

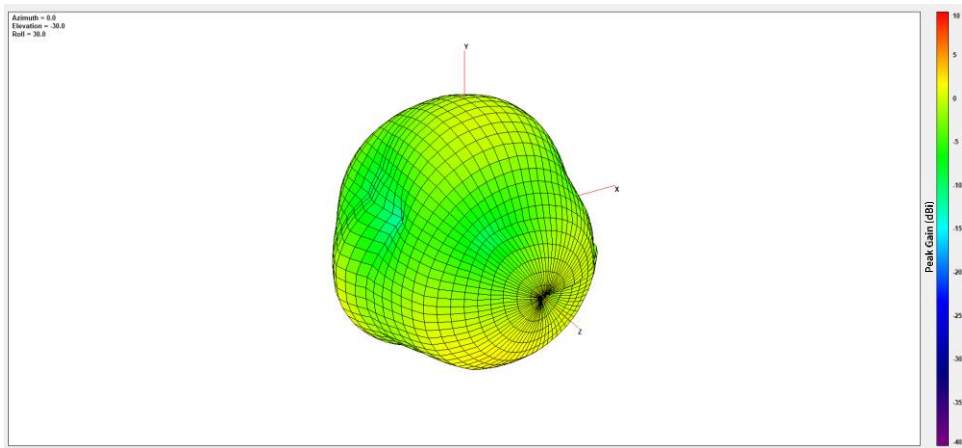

1520 MHz

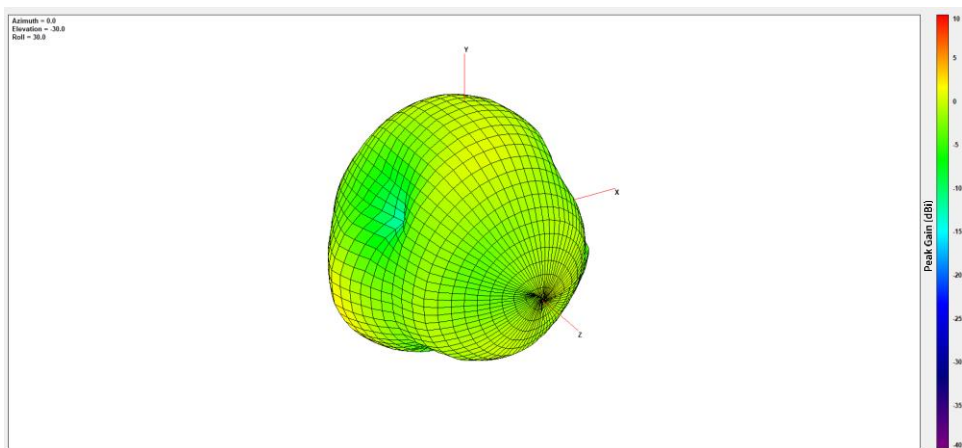

1710 MHz

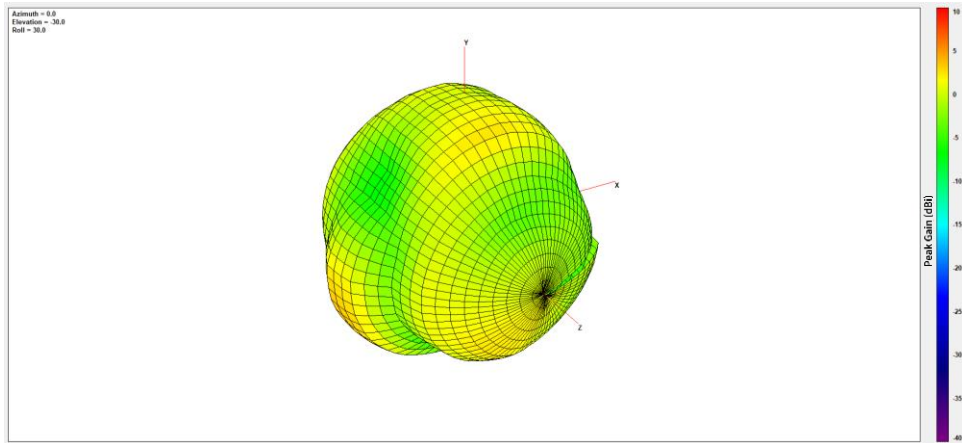

1850 MHz

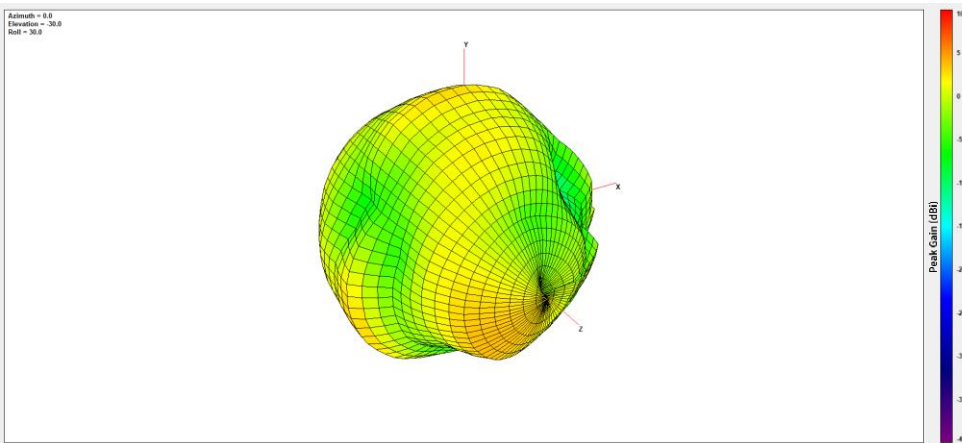

1910 MHz

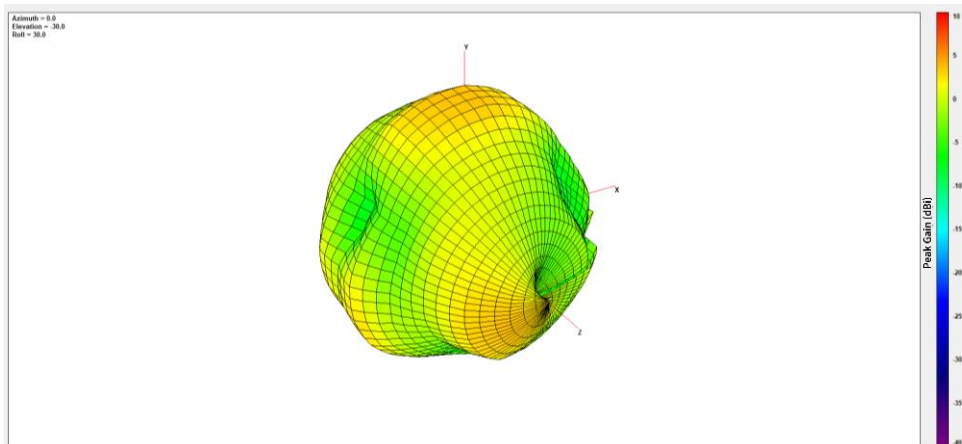

2450 MHz

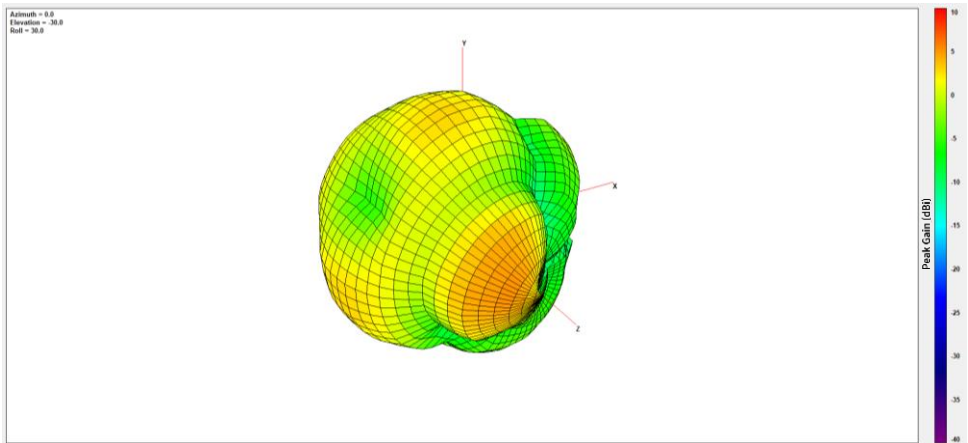

2550 MHz

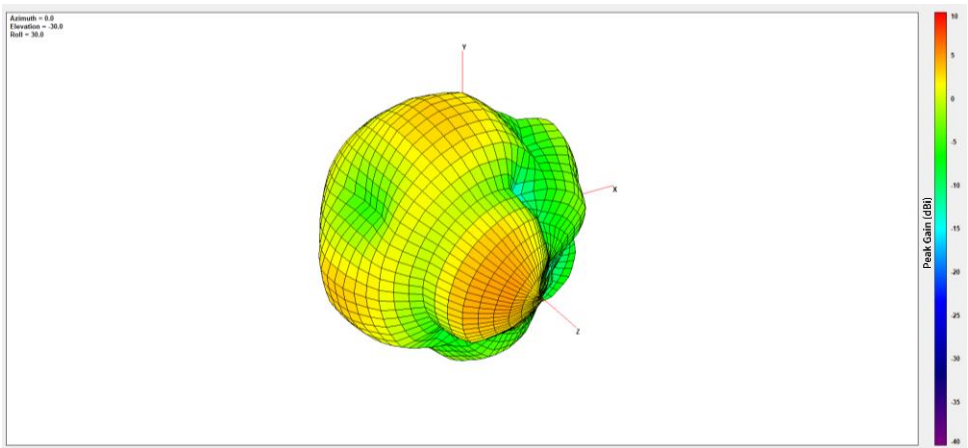

2700 MHz

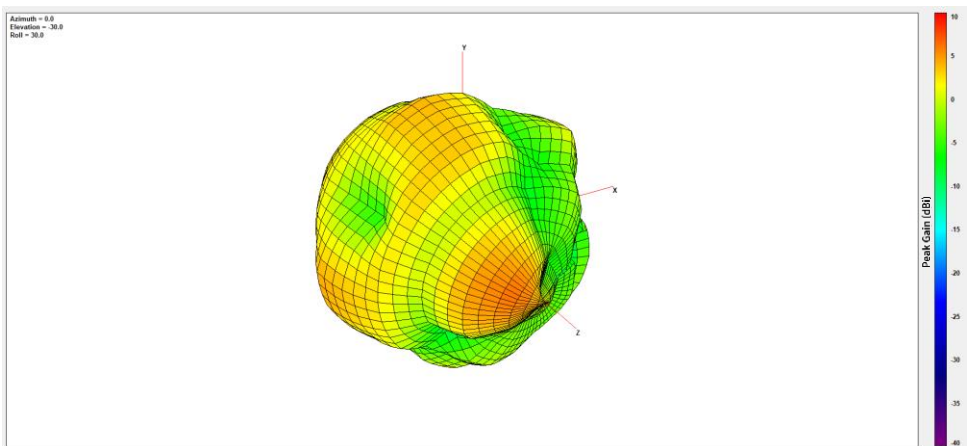

3300 MHz

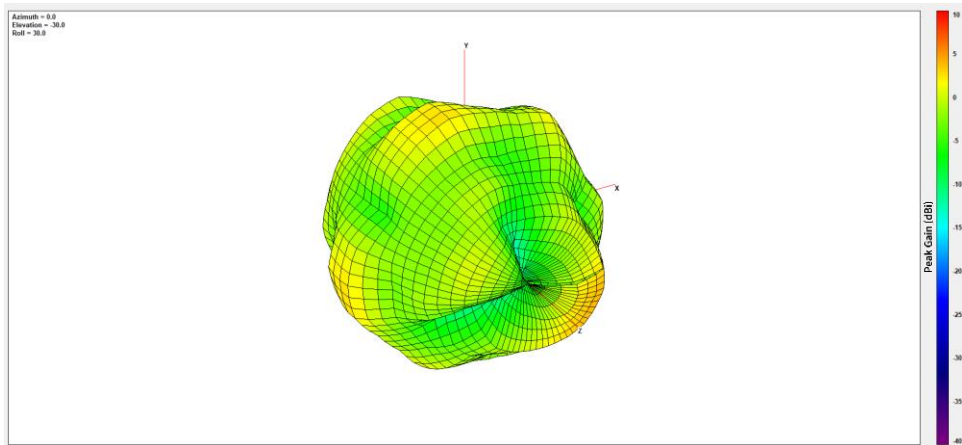

4300 MHz

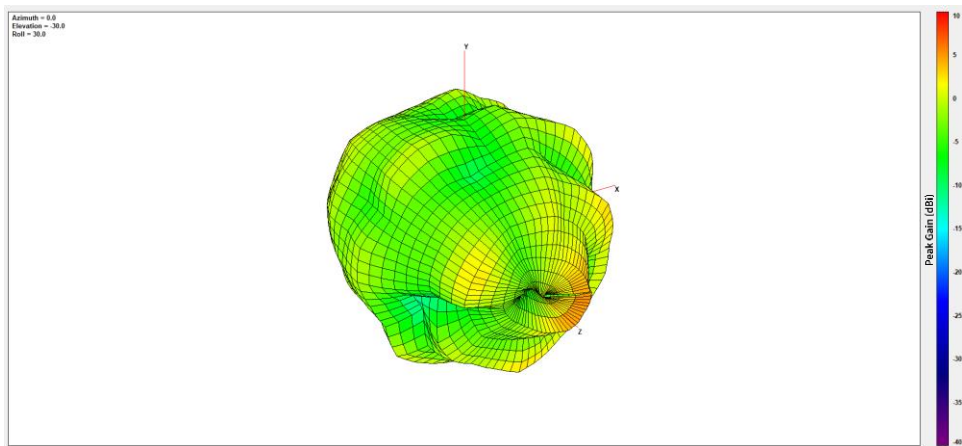

6000 MHz

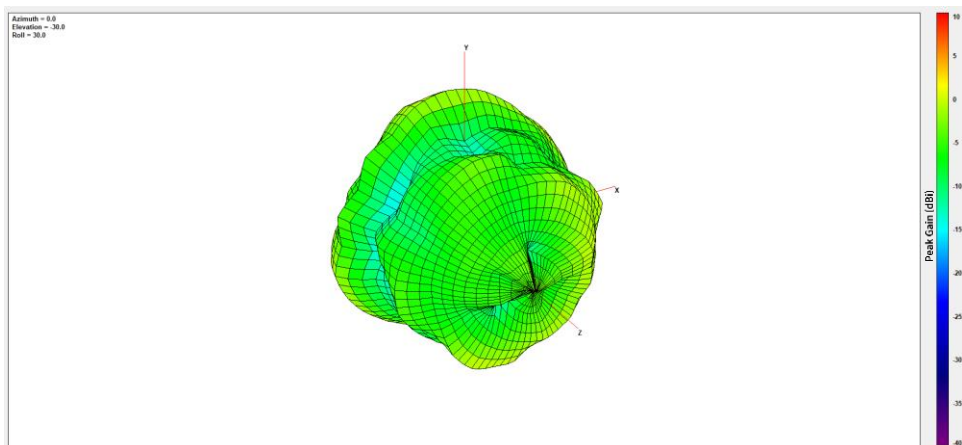

6. Mechanical Drawing (Units: mm)

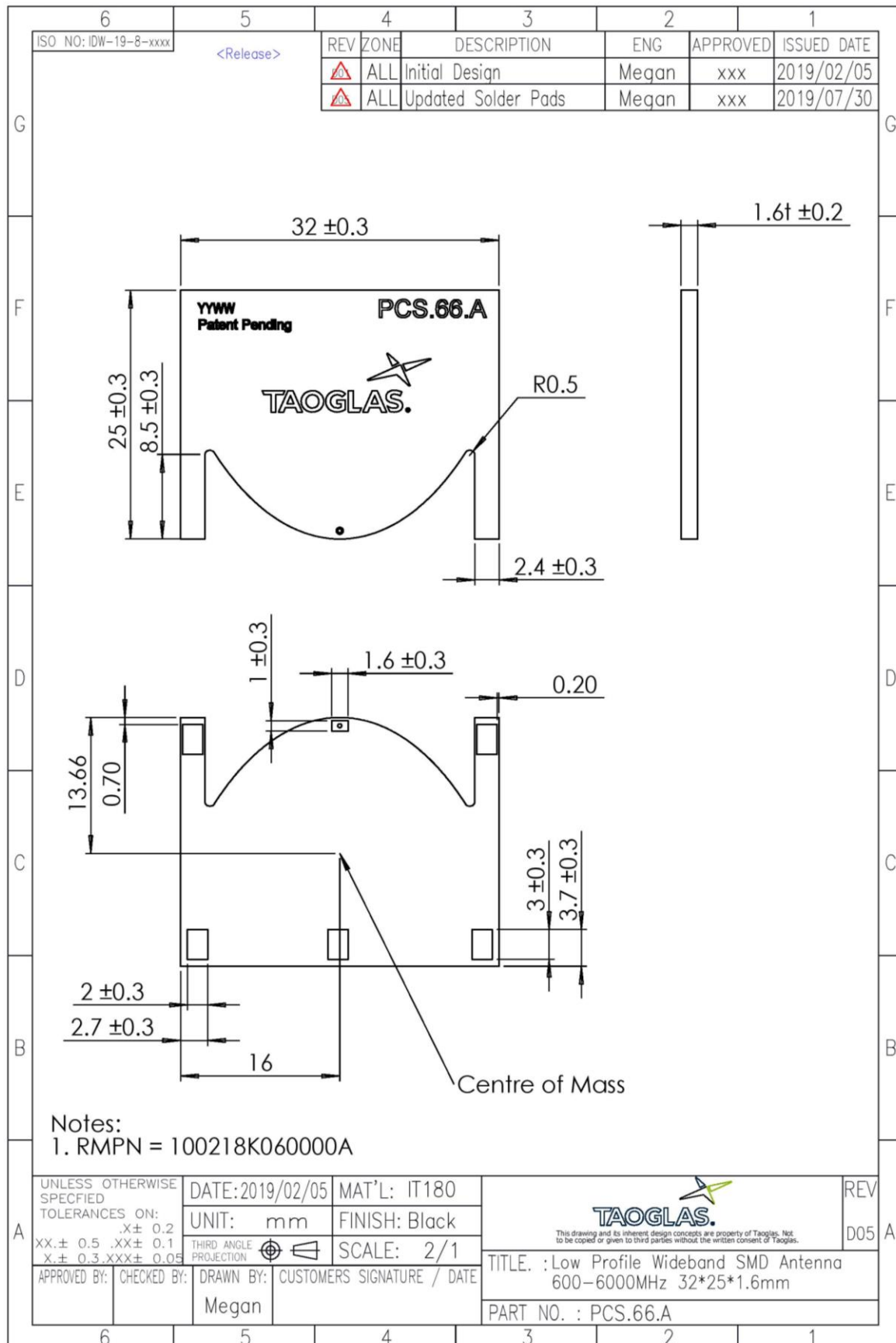

7. Layout Dimensions

Pads 2 and 3 are the same size. Pads 4 and 6 are the same size. Pad 1 should be connected to a 50 ohm transmission line.

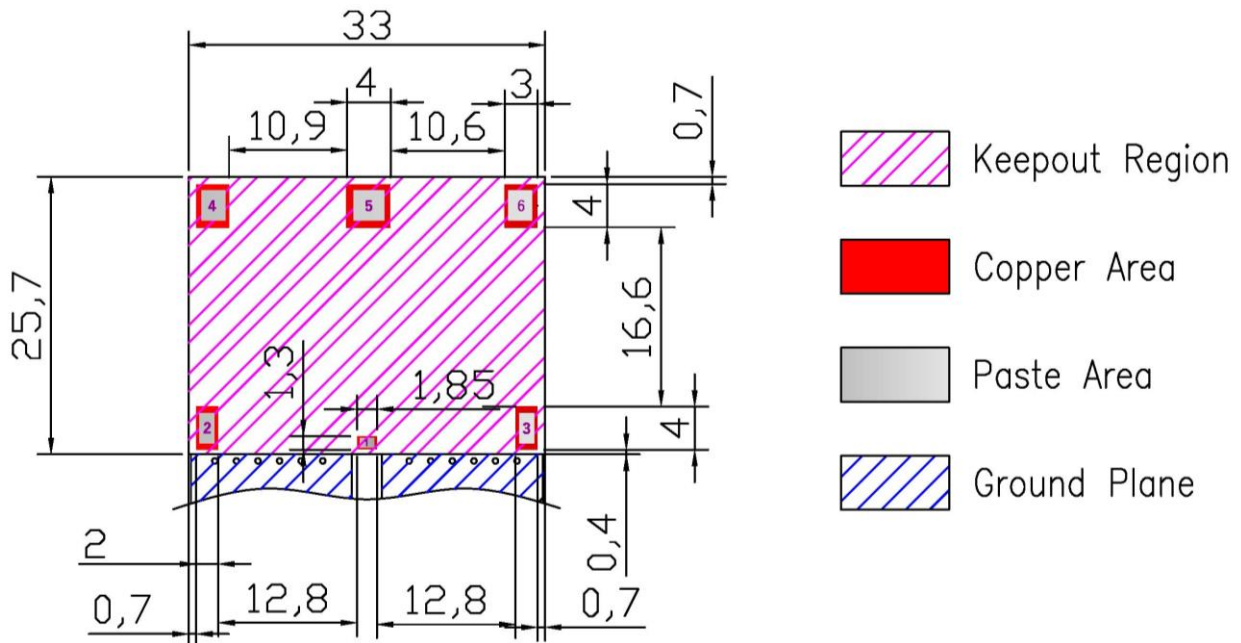

Note:

1. Ground Keepout should extend through any inner PCB layers and any sides around the antenna until the board edge to minimize coupling from feed to ground, except the side facing system ground
2. Any vias in pads should be either filled or tented to prevent solder from wicking away from the pad during reflow
3. The dimension tolerances should follow standard PCB manufacturing guidelines
4. Solder paste area is 75% of copper area dimensions
5. Centre of mass is 1.17mm offset in Y from geometric centre

8. EVB Drawing

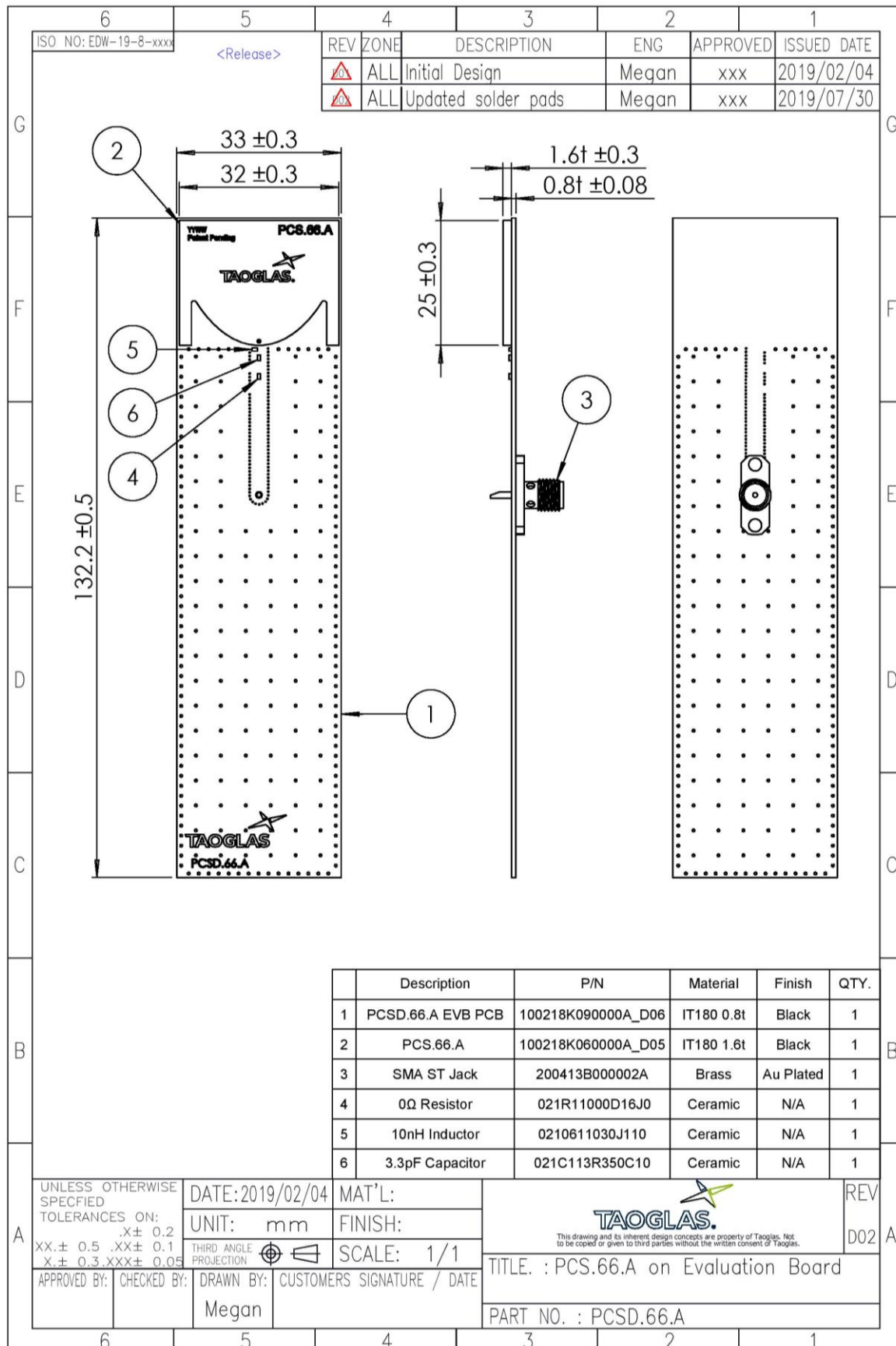

9. Matching Circuit

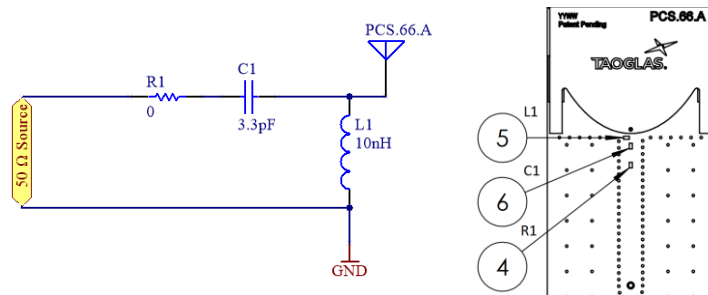

Circuit Symbol	Size	Description
L1	0402	10nH inductor (L-07C10NJV6T)
C1	0402	3.3pF Capacitor (GJM1555C1H3R3BB01D)

10. Packaging

500pcs PCS.66.A per Tape & Reel
 Dimensions - $\varnothing 330 \times 56$ mm
 Weight – 2.2Kg

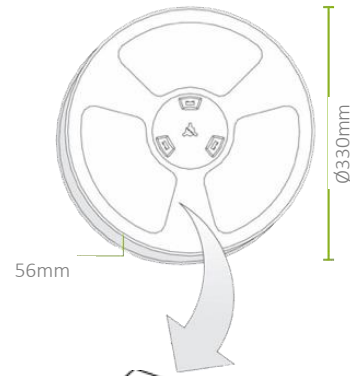

500pcs PCS.66.A per Box
 Dimensions - 350*340*85mm
 Weight – 2.3Kg

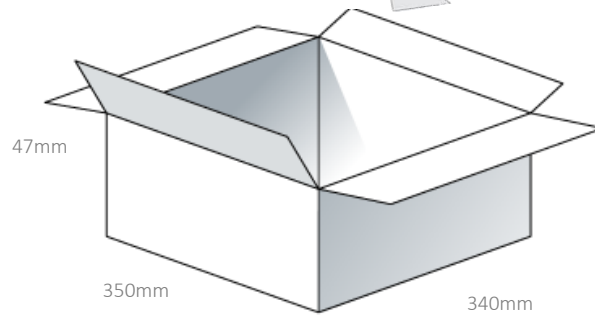

1500pcs PCS.66.A per Carton
 Dimensions - 360*370*275mm
 Weight – 7Kg

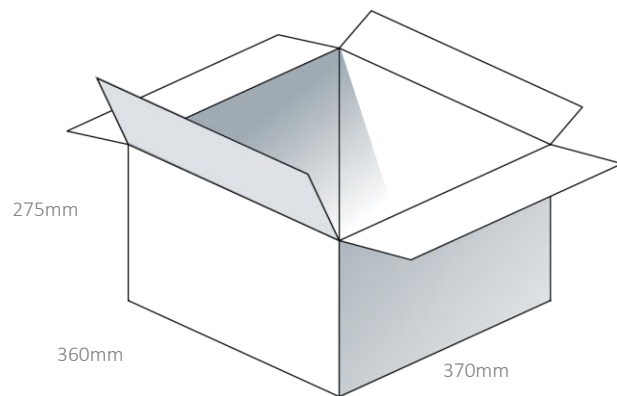

Pallet Dimensions:
 1100*720*1270mm
 24 Cartons Per Pallet
 6 Cartons Per Layer
 4 Layers

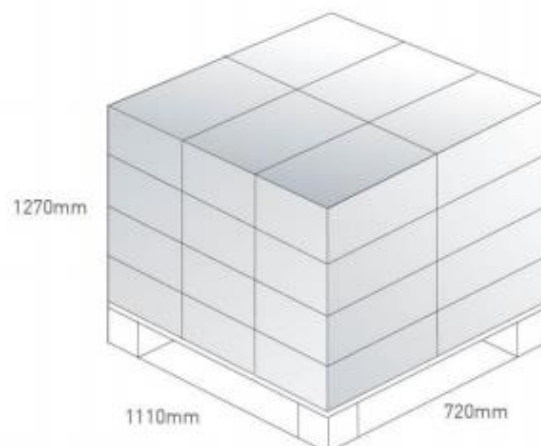

Changelog for the datasheet

SPE-19-8-012 – PCS.66.A

Revision: F (Current Version)

Date:	2021-07-13
Changes:	Updated MSL
Changes Made by:	Jack Conroy

Previous Revisions

Revision: E

Date:	2020-01-02
Changes:	Updated Packaging
Changes Made by:	Jack Conroy

Revision: D

Date:	2019-08-16
Changes:	Updated Drawings and Pad Layout
Changes Made by:	Jack Conroy

Revision: C

Date:	2019-08-02
Changes:	Updated Drawings
Changes Made by:	Jack Conroy

Revision: B

Date:	2019-04-26
Changes:	Updated Layout Dimensions & Added Packaging
Changes Made by:	Jack Conroy

Revision: A (Original Release)

Date:	2019-02-22
Notes:	Initial Datasheet Release
Author:	Yu Kai Yeung



www.taoglas.com



X-ON Electronics

Largest Supplier of Electrical and Electronic Components

Click to view similar products for [Antennas](#) category:

Click to view products by [Taoglas](#) manufacturer:

Other Similar products are found below :

[GAN30084EU](#) [930-033-R](#) [GW17.07.0250E](#) [1513563-1](#) [EXE902SM](#) [APAMPG-117](#) [MAF94383](#) [W3908B0100](#) [W6102B0100](#) [YE572113-30RSMM](#) [108-00014-50](#) [66089-2406](#) [SPDA17RP918](#) [A09-F8NF-M](#) [A09-F5NF-M](#) [RGFRA1903041A1T](#) [W3593B0100](#) [W3921B0100](#) [SIMNA-868](#) [SIMNA-915](#) [SIMNA-433](#) [W1044](#) [W1049B090](#) [A75-001](#) [WTL2449CQ1-FRSMM](#) [CPL9C](#) [EXB148BN](#) [0600-00060](#) [TRA9020S3PBN-001](#) [Y4503](#) [GD5W-28P-NF](#) [MA9-7N](#) [GD53-25](#) [GD5W-21P-NF](#) [C37](#) [MAF94051](#) [MA9-5N](#) [EXD420PL](#) [B1322NR](#) [QWFTB120](#) [MAF94271](#) [MAF94300](#) [GPSMB301](#) [FG4403](#) [AO-AGSM-OM54](#) [5200232](#) [MIKROE-2349](#) [WCM.01.0111](#) [MIKROE-2393](#) [MIKROE-2352](#)