



TAOGLAS®



Datasheet

Common Mode Choke

Part No:
TCMCFNT101-RD

Description:
Common Mode Choke, 100 Base-T1, PoDL
1 Channel
2518 size

Features:
350mA
60VDC
Automotive Grade
Meets AEC-Q200 standard

1. Specifications	3
2. Mechanical	4
3. Electrical	5
4. Characteristic Curve	8
5. Packaging	10
<hr/>	
Changelog	12

Taoglas makes no warranties based on the accuracy or completeness of the contents of this document and reserves the right to make changes to specifications and product descriptions at any time without notice. Taoglas reserves all rights to this document and the information contained herein. Reproduction, use or disclosure to third parties without express permission is strictly prohibited.



1. Specifications

Electrical Performance	
Inductance	100(μH) Typ @0.1V/100kHz
Current Rating	350 (mA) Max
DCR	1.60 (Ω) Max
Voltage Rating	60(V DC) Max
Turns Ratio (±2%)	1:1
Insertion Loss (Sdd21)	-1.0 dB Max @ 1-60MHz
Return Loss (Sdd11)	-28 dB Min @ 1-10MHz
	-23 dB Min @ 30MHz
	-18 dB Min @ 60MHz
Common Mode Rejection (Scc21)	-18 dB Min @1MHz:
	-35 dB Min @10MHz
	-43 dB Min @60-100MHz
	-30 dB Min @300MHz
	-25 dB Min @1000MHz
Differential Mode Rejection (Sds21)	-65 dB Min @1-10MHz
	-50 dB Min @100MHz
	-35 dB Min @300MHz
	-25 dB Min @1000MHz

Environmental Specifications	
Operating Temperature	-40°C to +125°C (including self-temperature rise)
	All test data referenced to 25°C ambient. Heat Rated Current (Irms) will cause the coil temperature rise approximately ΔT of 40°C Max

Mechanical	
Product Weight	0.311 g
Reliability Test	Meets AEC-Q200 standard

Storage requirements	
Storage Temperature	40°C to +125°C (on board)
Storage Condition (Component in its packaging)	Temperature: Less than 40°C Humidity Less than 60% RH

2. Mechanical

2.1 Mechanical Drawings

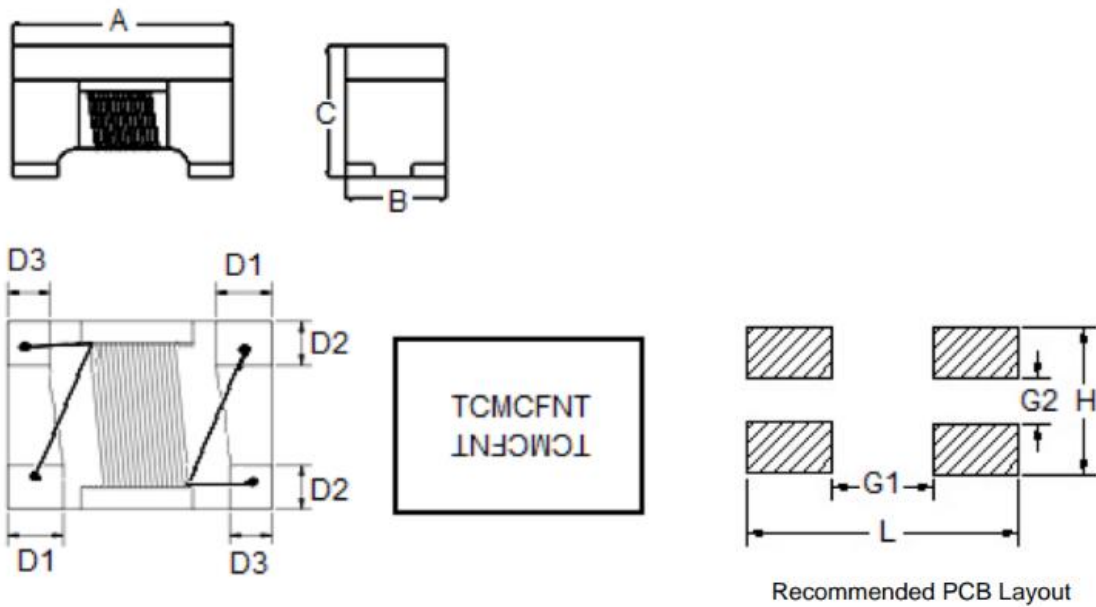

Note: 1. The above PCB layout reference only.

A	B	C	D1	D2
6.50±0.30	4.50±0.20	2.60±0.20	0.88±0.20	1.30±0.20
D3	L	H	G1	G2
0.76±0.15	7.20 Ref	4.60 Ref	5.08 Ref	2.60 Ref

2.2 Material list

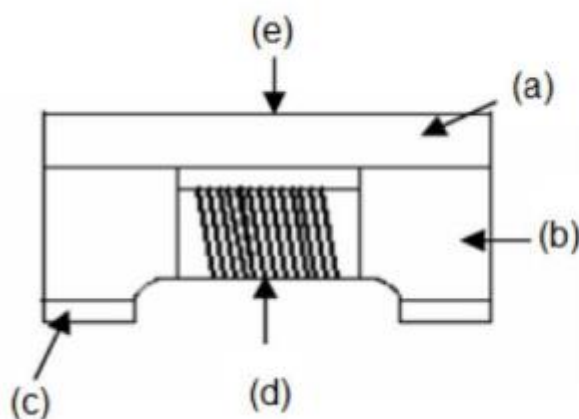

- (a) Upper Plate
- (b) Core
- (c) Termination
- (d) Wire
- (e) Mark

3. Electrical

3.1 Schematic

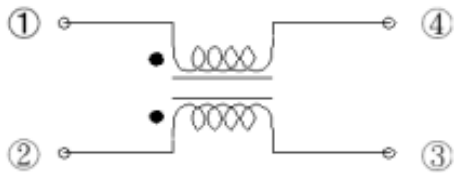

Common mode

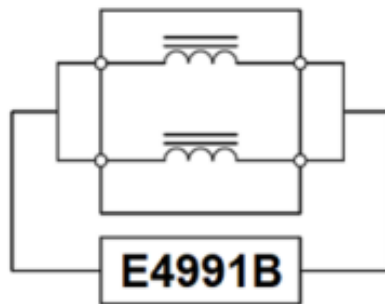

Differential mode

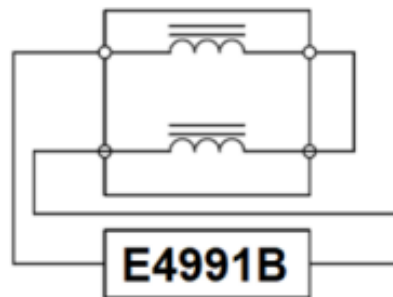

3.2 IR Reflow Profile

Mildly activated rosin fluxes are preferred. Our terminations are suitable for re-flow soldering systems. If hand soldering cannot be avoided, the preferred technique is the utilization of hot air soldering tools.

IR Soldering Reflow

Recommended temperature profiles for lead free re-flow soldering in Figure 1, Table 1.1 & 1.2 (J-STD-020E).

Iron Reflow

Products attachment with a soldering iron is discouraged due to the inherent process control limitations. In the event that a soldering iron must be employed the following precautions are recommended (Figure 2).

Note:

- Preheat circuit and products to 150°C.
- 355°C tip temperature (Max.)
- Never contact the ceramic with the iron tip
- 1.0mm tip diameter (Max.)
- Use a 20 watt soldering iron with tip diameter of 1.0mm
- Limit soldering time to 4~5 sec.

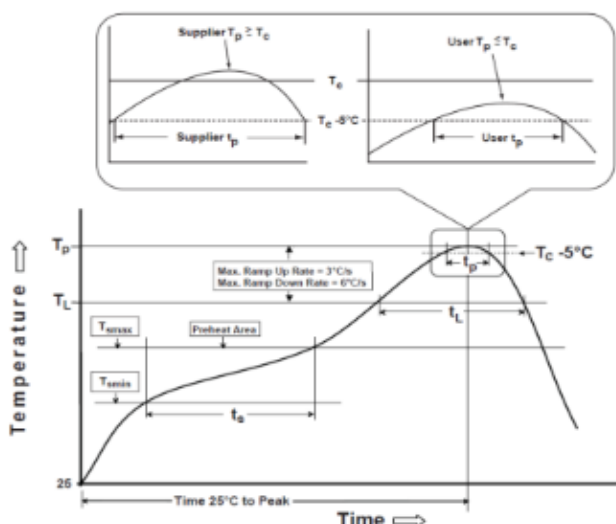

Reflow times: 3 times Max

Figure 1: IR Soldering Reflow

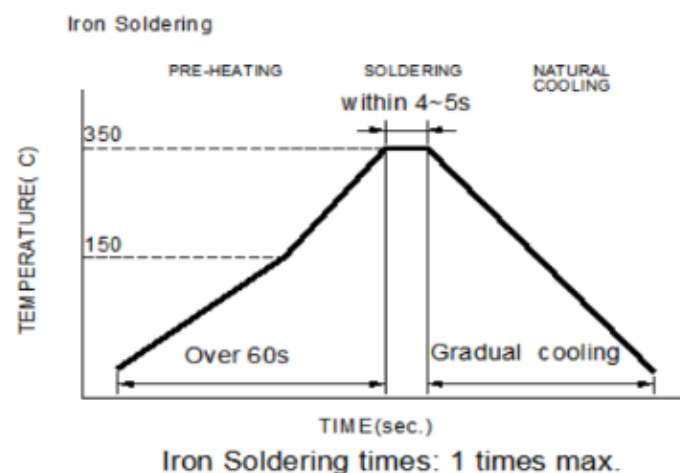

Soldering iron method: 350±5°C Max

Figure 2: Iron soldering temperature profiles

3.3 Reflow Profiles

Table (1.1) Reflow Profiles

Profile Type:	Pb-Free Assembly
Preheat	
-Temperature Min (T_{smin})	150°C
-Temperature Max (T_{smax})	200°C
-Time (t_s) from (T_{smin} to T_{smax})	60-120seconds
Ramp-up rate (T_L to T_p)	3°C /second max.
Liquids temperature (T_L)	217°C
Time (t_L) maintained above T_L	60-150 seconds
Classification temperature (T_c)	See Table (1.2)
Time (t_p) at $T_c - 5^\circ\text{C}$ (T_p should be equal to or less than T_c .)	* < 30 seconds
Ramp-down rate (T_p to T_L)	6°C /second max.
Time 25°C to peak temperature	8 minutes max.

T_p: maximum peak package body temperature, **T_c**: the classification temperature.

For user (customer) **T_p** should be equal to or less than **T_c**.

*Tolerance for peak profile temperature (T_p) is defined as a supplier minimum and a user maximum.

Table (1.2) Package Thickness/Volume and Classification Temperature (T_c)

	Package Thickness	Volume mm ³ <350	Volume mm ³ 350-2000	Volume mm ³ >2000
PB-Free Assembly	<1.6mm	260°C	260°C	260°C
	1.6-2.5mm	260°C	250°C	245°C
	≥2.5mm	250°C	245°C	245°C

Reflow is referred to standard IPC/JEDEC J-STD-020E.

4. Characteristic Curve

4.1 Sdd11/22 & Sdd12/21

Sdd11/22

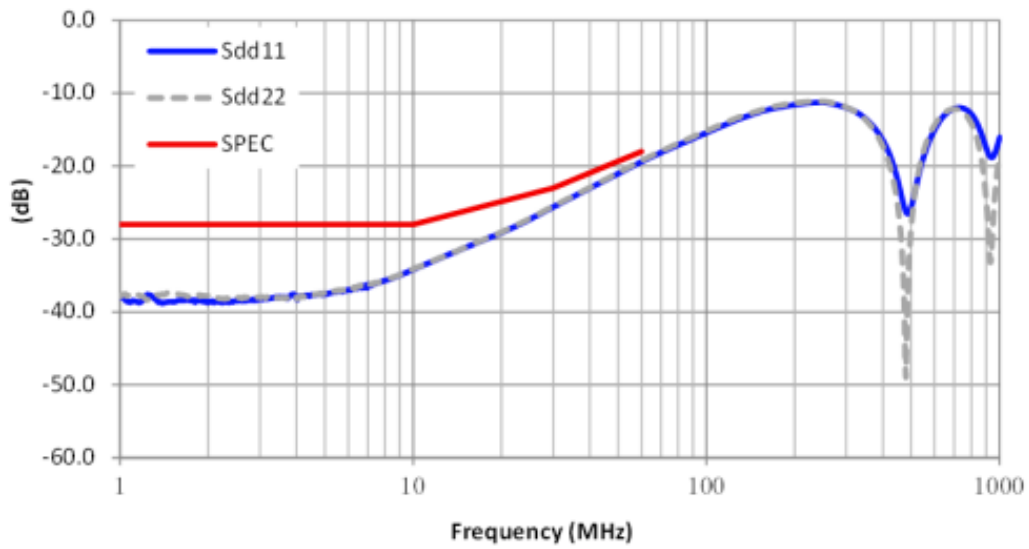

Sdd12/21

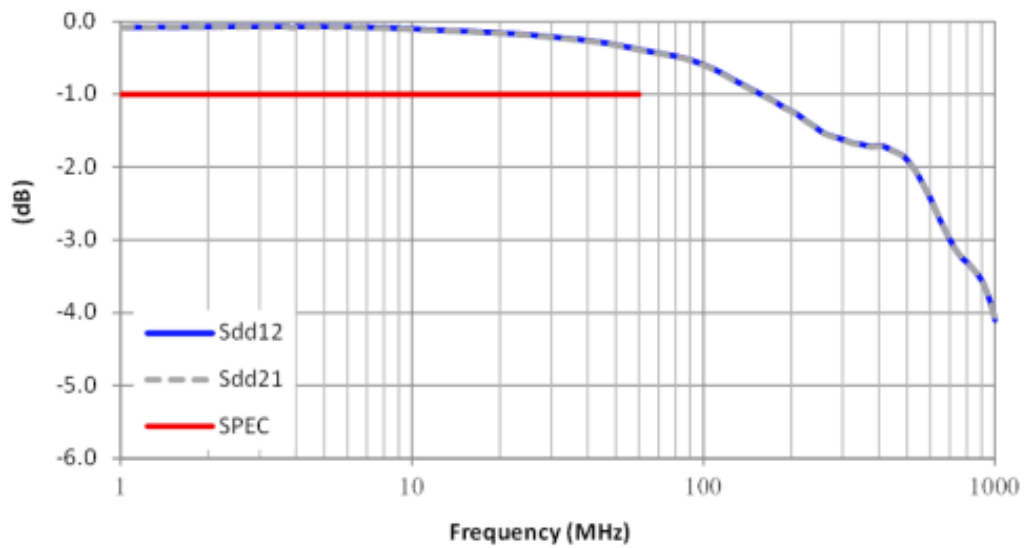

4.2 Scc12/21 & Ssd12/Sds21

Scc12/21

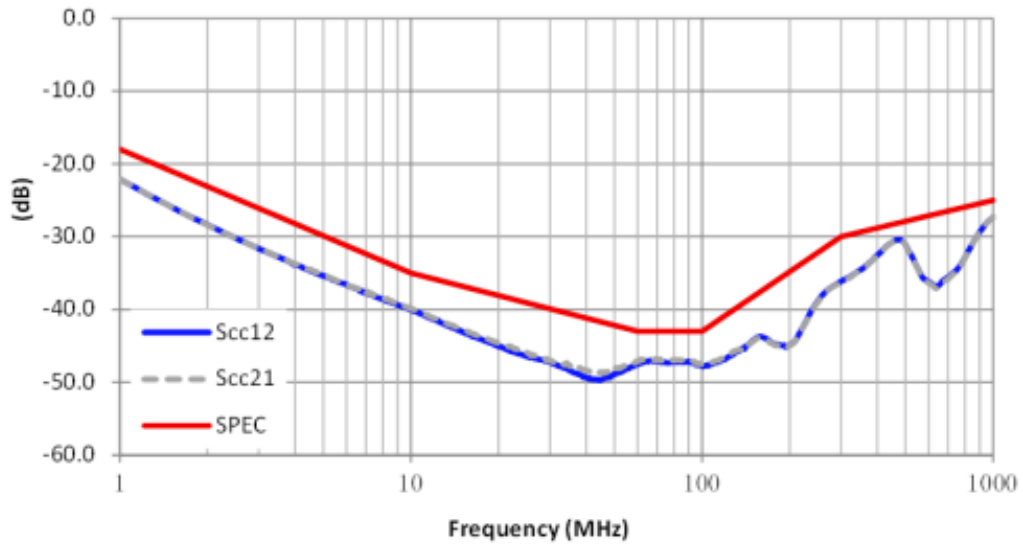

Sds 12/Sds21

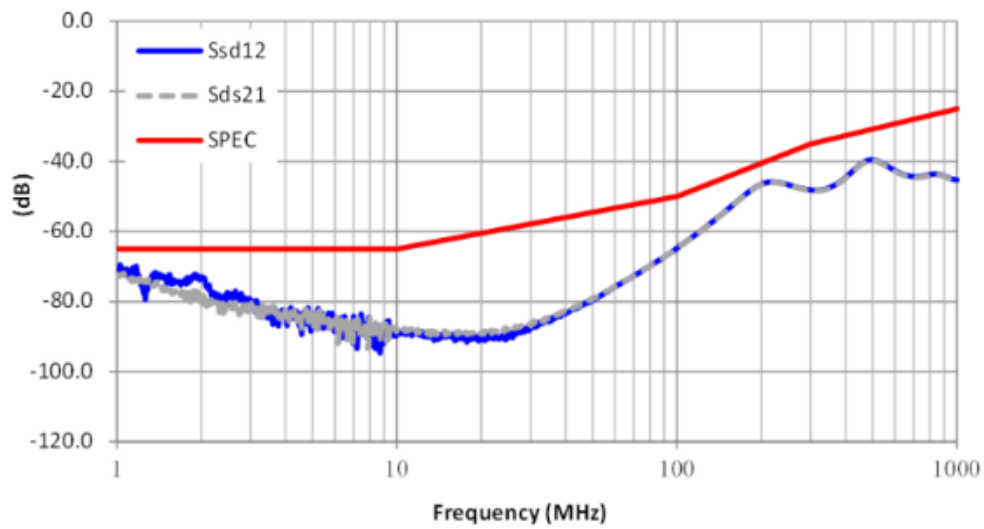

5. Packaging

5.1 SPQ

1 reel = 500 pcs

Weight: 238.2g

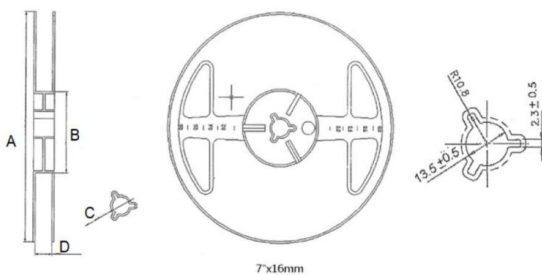

Type	A	B	C	D
7" x 16mm	178.0±2.0	60.0±2.0	13.5±0.5	16.7±0.5

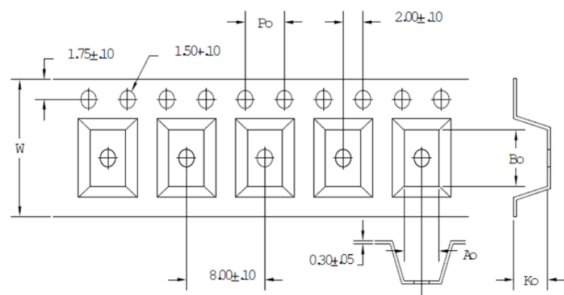

W	Po	Ao	Bo	Ko
16.00±0.30	4.00±0.10	4.90±0.10	6.90±0.10	2.90±0.10

9-3. Packaging Quantity

Packaging	Quantity (Pcs)	Weight (g)	Packaging Size (mm)
Chip/ Reel	500	238.2	7" x 16mm
Inner Box	2,000	1014.2	184 x 89 x 190
Middle Box	10,000	5279.3	485 x 197 x 200
Carton	20,000	11328.1	503 x 412 x 227

9-4. Tearing Off Force

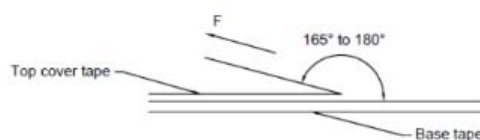

The force for tearing off cover tape is according to the follow table, in the arrow direction under the following conditions.

(Referenced ANSI/EIA-481-D-2008 of 4.11 standard)

Room Temp. (°C)	Room Humidity (%)	Room atm (hPa)	Tearing Speed (mm/min)
5~35	45~85	860~1060	300±10

Tape Size	8 mm	12 to 56 mm	72 mm or Wider
Tearing Off Force (grams)	10~100	10~130	10~150

5.2 Carton

1 Carton = 40 reels = 20000 pcs
 Carton dimensions: 503*412*227 mm
 Carton Weight: 11.328 kg



5.3 Label

Taoglas Limited	
P/N NO: XXXXXXXX	
QYT: XXX PCS	DC: XXXX
DATE: XXXX-XX-XX	

SPQ Label (8x4cm)

Taoglas Limited	
P/N NO: XXXXXXXX	
PO: XXXXXXXX	B/N: XXXXXXXX
QYT: XXX PCS	DC: XXXX
DATE: XXXX-XX-XX	

Carton Label (8x4cm)

Changelog

Changelog for the datasheet

SPE-23-8-310 – TCMCFNT101-RD

Revision: A (Original First Release)

Date:	2023-10-27
Notes:	
Author:	Javier Vasena

Previous Revisions



www.taoglas.com



X-ON Electronics

Largest Supplier of Electrical and Electronic Components

Click to view similar products for [Common Mode Chokes / Filters](#) category:

Click to view products by [Taoglas](#) manufacturer:

Other Similar products are found below :

[PE-64683](#) [RD6137-6-7M5](#) [RD8147-16-3M0](#) [ST6118T-R](#) [FE3X025-10-7NL](#) [RD7147-25-0M7](#) [TCM0806G-350-2P-T](#) [TCM0806G-650-2P-T](#)
[IND-0110](#) [UAL21VR0802000](#) [UALSC023000000](#) [UALSC1020JH000](#) [UALSU10VD20010](#) [UALSU9VD070100](#) [36-00037](#)
[UALW21HS072450](#) [UALSU9H0208000](#) [UAL24VK06450CH](#) [PLT10HH501100PNB](#) [PLT10HH401100PNB](#) [PLT10HH1026R0PNB](#) [PE-](#)
[67531](#) [TLH10UB](#) [113 0R5](#) [2752045447](#) [7351V](#) [CMF16-153131](#) [RD7147-6-6M0](#) [T8116NLT](#) [CMS2-10-R](#) [FE2X10-4-2NL](#) [36-00029-07](#)
[T8003NLT](#) [CTX01-13663](#) [CTX66-19521-R](#) [RC212-0.5-10M](#) [RC112-0.4-15M](#) [RC212-0.6-6M8](#) [RC212-0.4-15M](#) [RC112-0.3-30M](#)
[PH9408.814NLT](#) [PAC6006.364NLT](#) [PAC6006.444NLT](#) [PAC6006.204NLT](#) [PH9407.204NLT](#) [PH9408.494NLT](#) [PAC6006.104NLT](#)
[CM6350R-683-REEL](#) [CUW43T-513T-AU](#) [CUW43T-104T-AU](#) [SCM9250-400N](#)