

## Specification

- Part No. : **TG.08.0723**
- Product Name : Cellular and GPS/GLONASS/GALILEO/BEIDOU  
Hinged Fakra Connector Mount Antenna
- Features : Compact Passive Monopole Antenna  
High Efficiencies at Cellular and GNSS frequencies  
Fits in places other antennas just don't  
360° rotatable with durable brass hinge  
Compatible with:
  - 2G (GSM / DCS / PCS)
  - 3G (CDMA / WCDMA / UMTS / HSPA)
  - 4G (LTE)
  - GNSS (GPS / GLONASS / GALILEO/ BEIDOU)Fakra Code D Bordeaux Violet SMB(F) Connector  
Length: 79.5mm  
**ROHS Compliant**



## 1. Introduction

The compact TG.08 with hinged rotatable Fakra Code D connector is a monopole antenna for automotive telematics applications that provides wide coverage among cellular and GNSS frequencies and offers impressively high efficiencies. It fits in crowded device environments.

It's robust brass hinge enables TG.08 to be oriented in all directions, allowing users to maximize performance with minimum effort. The Fakra connector gives additional mechanical robustness over a traditional SMA connector since it locks securely with its mate and will not come loose due to vibrations or impacts.

This 72mm long monopole antenna has good efficiency in the 700MHz to 2700MHz range, covering the 2G/3G/4G bands, as well as GPS/GLONASS/BEIDOU. When connected to a ground plane, it can achieve up to 75% efficiency at GPS and LTE bands.

With its cellular and GNSS function, plus compact design, TG.08 is a great antenna for routers, vehicle tracking devices, telematic devices, and remote monitoring systems. It is also ideal for use in cellular modules with Assisted GPS functionality that can be implemented in various devices.

As with all monopole antennas, TG.08 works best when connecting directly to the ground-plane of the device main-board or to the device's metal enclosure. For optimum radiation efficiency care should be taken to keep the radiating element of the antenna as far away from metal as possible.



## 2. Specification

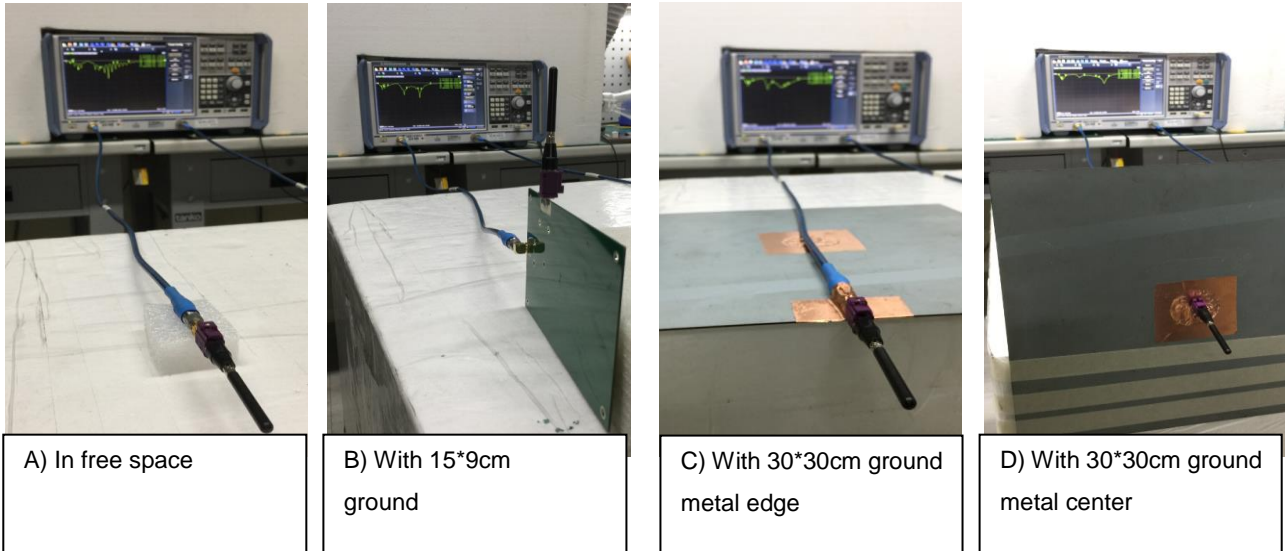
Parameter										
Straight Position										
Band		<b>700LTE</b>	<b>GSM</b>	<b>BEIDOU</b>	<b>GPS</b>	<b>GLONASS</b>	<b>DCS</b>	<b>PCS</b>	<b>UMTS/ HSPA</b>	<b>2700LTE</b>
Frequency (MHz)		<b>703~ 803</b>	<b>824~ 960</b>	<b>1561</b>	<b>1575.42</b>	<b>1602</b>	<b>1710~ 1880</b>	<b>1850~ 1990</b>	<b>1920~ 2170</b>	<b>2490~ 2690</b>
Average Gain (dBi)	In Free Space	-7.08	-3.34	-2.69	-2.64	-2.19	-2.27	-2.36	-2.47	-4.08
Efficiency (%)		19.93	46.55	53.87	54.45	60.38	59.31	58.12	56.62	39.81
Peak Gain (dBi)		-1.96	1.82	1.87	1.88	2.30	3.43	3.55	3.55	3.62
Return Loss (dB)		< -2	< -4	< -9	< -8	< -8	< -10	< -8	< -5	< -3
Average Gain (dBi)	With 15x9cm Ground	-2.16	-2.40	-2.01	-1.92	-1.67	-2.74	-2.42	-2.37	-6.30
Efficiency (%)		61.04	57.99	63.01	64.29	68.15	53.30	57.34	58.00	23.88
Peak Gain (dBi)		1.61	1.55	2.00	2.04	2.20	2.99	3.95	4.72	0.54
Return Loss (dB)		< -8	< -5	< -10	< -10	< -10	< -6	< -6	< -7	< -2
Average Gain (dBi)	On 30x30cm Ground Metal Edge	-1.76	-1.80	-1.06	-1.19	-1.15	-1.66	-1.22	-1.19	-4.03
Efficiency (%)		67.10	66.26	78.34	75.97	76.77	68.30	75.58	76.02	40.15
Peak Gain (dBi)		2.09	1.35	4.27	4.18	4.37	3.48	3.70	4.28	3.65
Return Loss (dB)		< -8	< -6	< -10	< -10	< -10	< -9	< -10	< -10	< -4
Average Gain (dBi)	On 30x30cm Ground Metal Center	-3.49	-1.98	-3.43	-3.37	-3.35	-3.34	-2.95	-2.66	-2.44
Efficiency (%)		46.33	63.95	45.36	46.07	46.20	46.41	50.82	54.33	57.42
Peak Gain (dBi)		1.37	2.52	1.47	1.50	1.43	1.17	1.76	2.68	3.40
Return Loss (dB)		< -3	< -4	< -6	< -5	< -5	< -3	< -3	< -4	< -6

Bent Position										
Average Gain (dBi)	In Free Space	-7.45	-3.54	-2.56	-2.54	-2.14	-2.30	-2.42	-2.57	-4.29
Efficiency (%)		18.25	44.69	55.42	55.66	61.13	58.87	57.24	55.32	37.76
Peak Gain (dBi)		-2.75	1.68	2.17	2.19	2.57	3.28	3.41	3.41	3.26
Return Loss (dB)		< -2	< -4	< -8	< -7	< -7	< -10	< -8	< -4	< -3
Average Gain (dBi)	With 15x9cm Ground	-2.52	-2.01	-2.10	-1.97	-1.68	-2.62	-2.34	-2.31	-6.36
Efficiency (%)		56.59	63.28	61.62	63.50	67.92	54.71	58.37	58.73	23.51
Peak Gain (dBi)		1.47	1.55	2.40	2.44	2.62	3.05	4.04	4.67	0.35
Return Loss (dB)		< -5	< -7	< -10	< -10	< -10	< -7	< -7	< -8	< -2
Average Gain (dBi)	On 30x30cm Ground Metal Edge	-2.22	-1.43	-1.06	-1.21	-1.14	-1.65	-1.24	-1.22	-3.29
Efficiency (%)		61.30	72.15	78.32	75.76	76.86	68.38	75.28	75.55	47.63
Peak Gain (dBi)		2.46	2.50	3.94	3.81	3.87	3.04	3.97	4.44	4.37
Return Loss (dB)		< -6	< -7	< -10	< -10	< -10	< -9	< -10	< -10	< -4
Average Gain (dBi)	On 30x30cm Ground Metal Center	-6.65	-3.06	-2.28	-2.34	-2.44	-3.00	-2.82	-2.61	-2.71
Efficiency (%)		23.10	49.79	59.19	58.34	56.99	50.15	52.34	54.95	54.27
Peak Gain (dBi)		-0.80	1.78	2.03	1.93	1.79	1.56	1.87	2.69	3.30
Return Loss (dB)		< -1	< -4	< -9	< -8	< -7	< -4	< -4	< -4	< -8
Radiation	Omni-directional									
Polarization	Linear									
Impedance	50 Ω									
Input Power	10W									
<b>MECHANICAL</b>										
Antenna length	79.5mm									
Antenna Diameter	5mm									
Casing	POM									
Connector	Fakra Code D									
Weight	8.5g									
<b>ENVIRONMENTAL</b>										
Operation Temperature	-40°C ~ + 85°C									
Storage Temperature	-40°C ~ + 85°C									
Humidity	Non-condensing 65°C 95% RH									

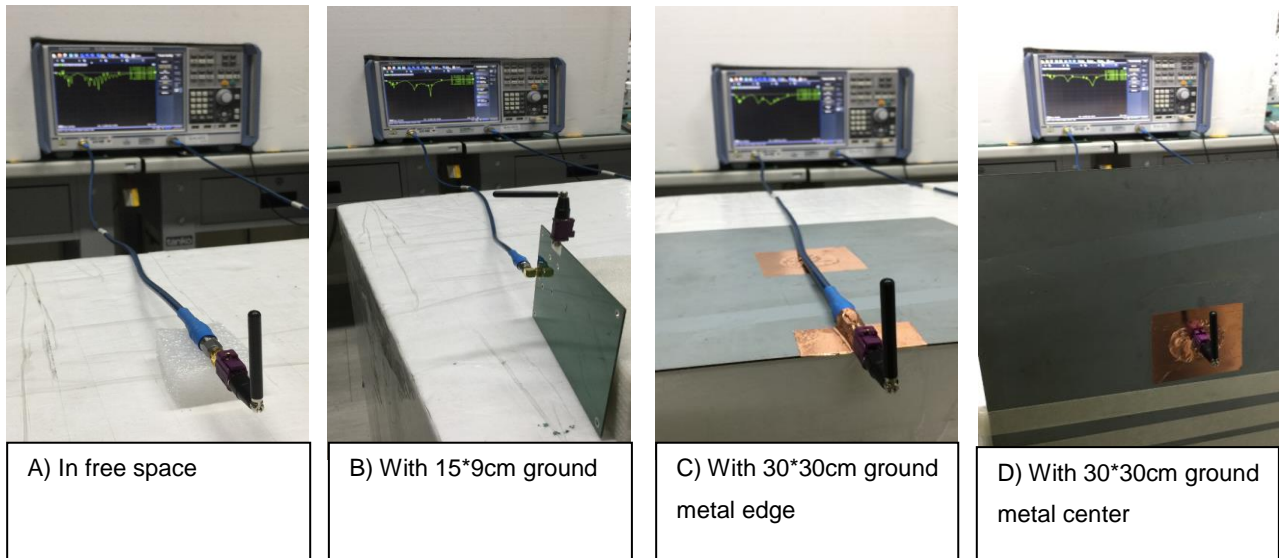
# 1. Antenna Characteristics

## 3.1 Testing setup

### Straight Antenna Position

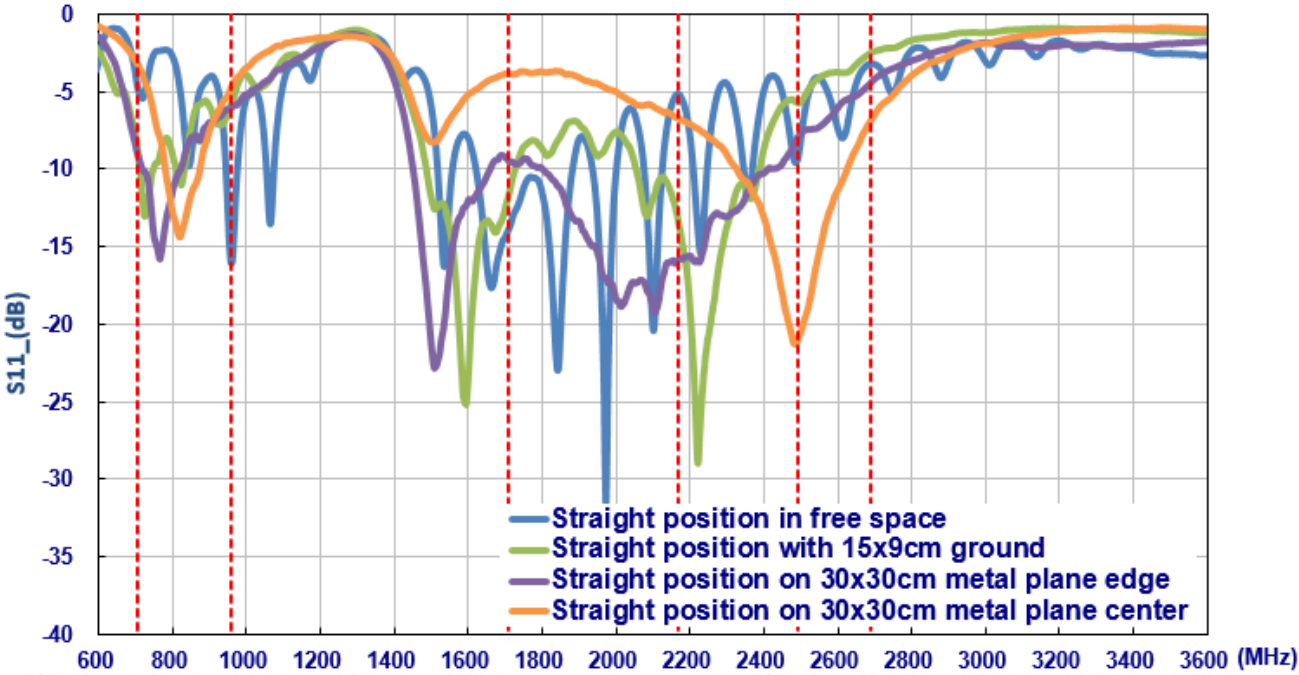


### Bent Antenna Position

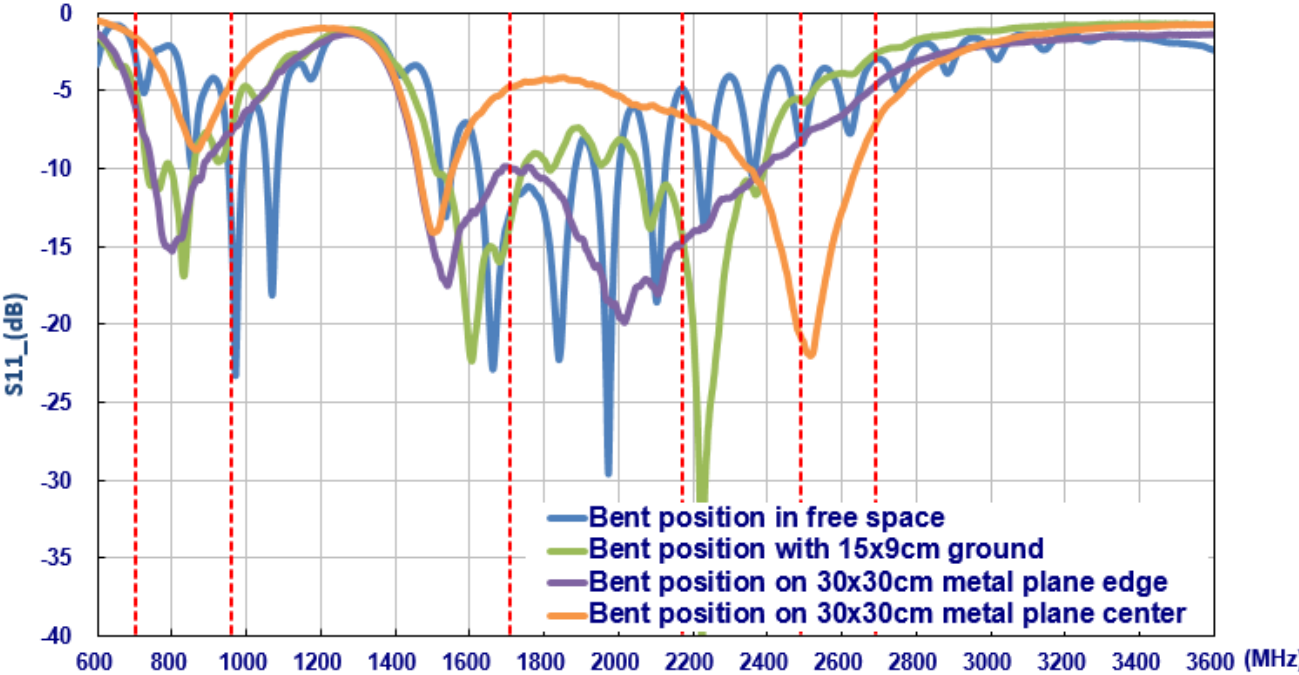


**Figure 1.** Measurement Environments

● **Return Loss**

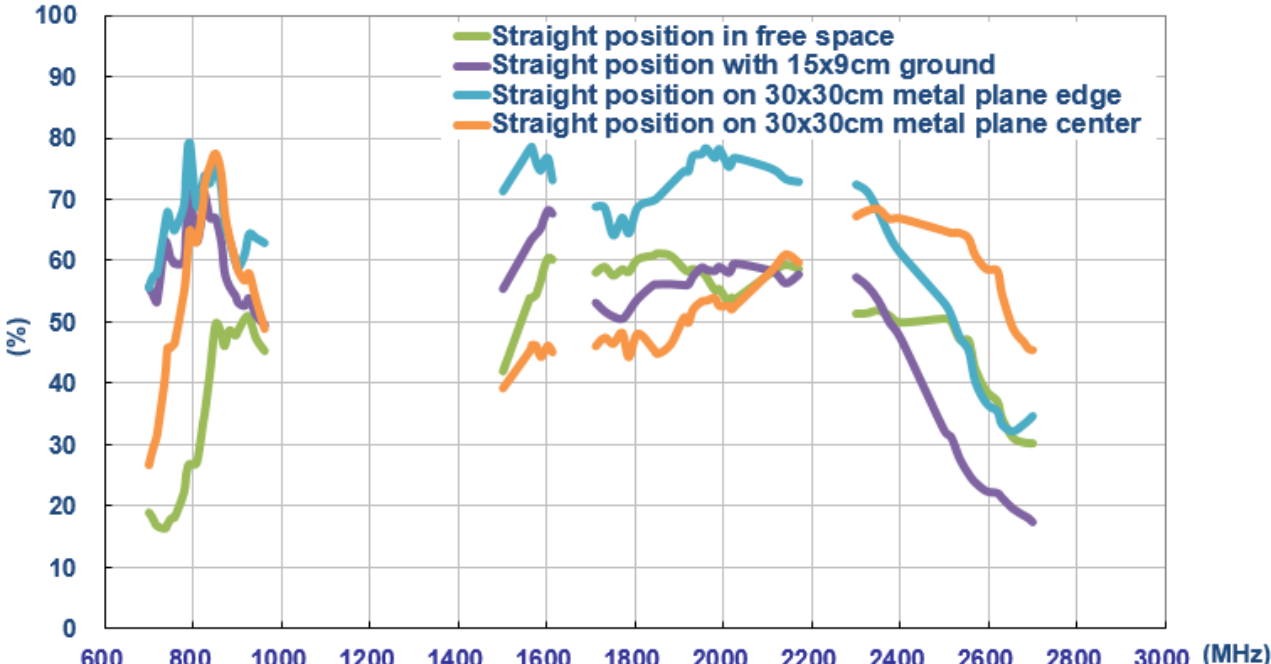


**Figure 2.** Return Loss of TG.08 antenna in straight position

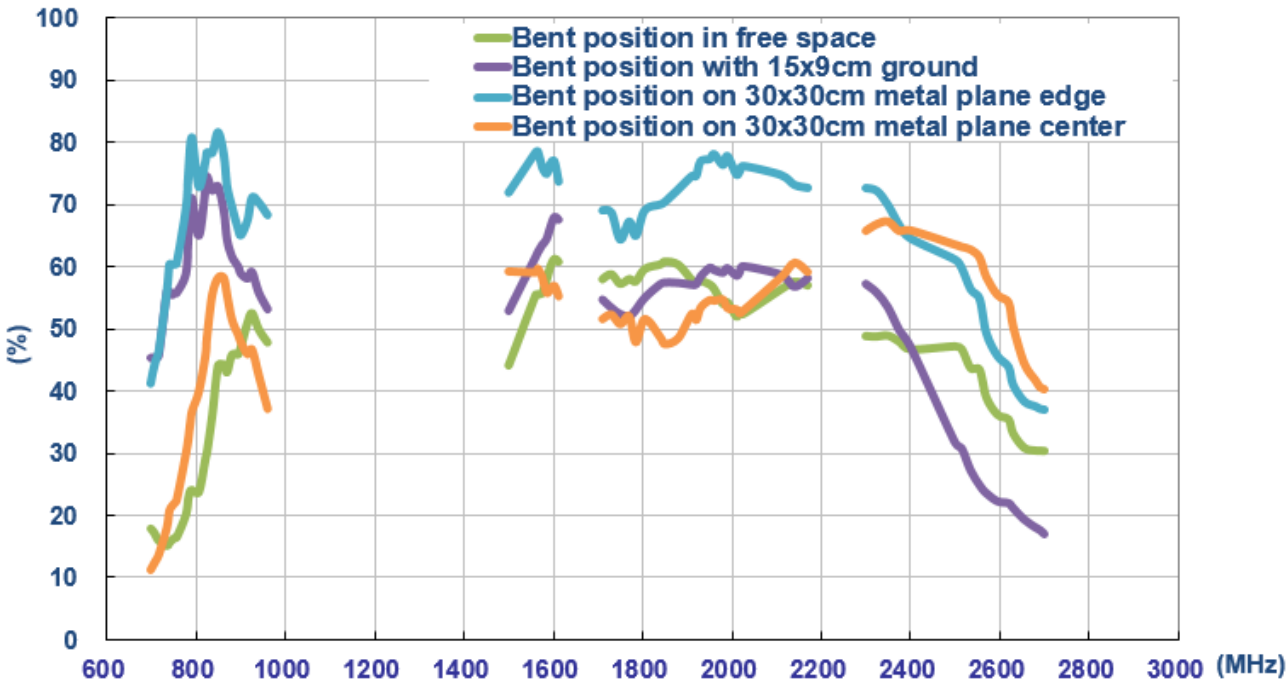


**Figure 3.** Return loss of TG.08 antenna in bent position

● **Efficiency**



**Figure 4.** Efficiency of TG.08 antenna in straight position



**Figure 5.** Efficiency of TG.08 antenna in bent position

● Peak Gain

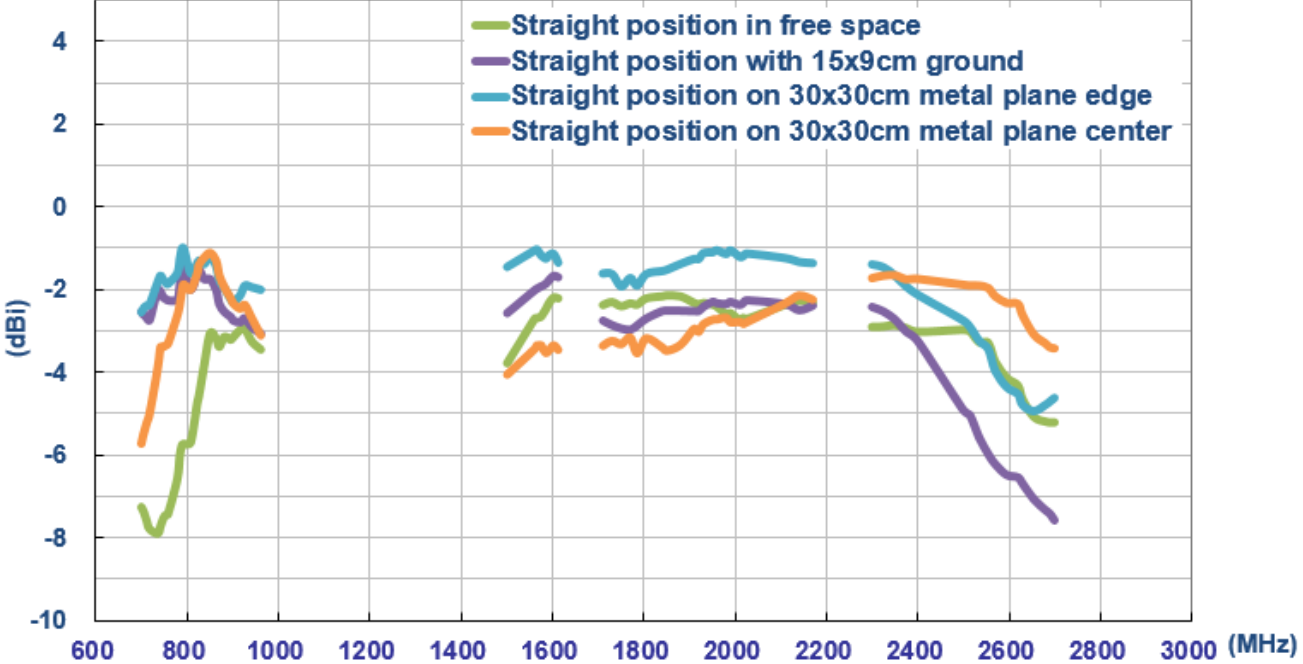


Figure 6. Peak gain of TG.08 antenna in straight position

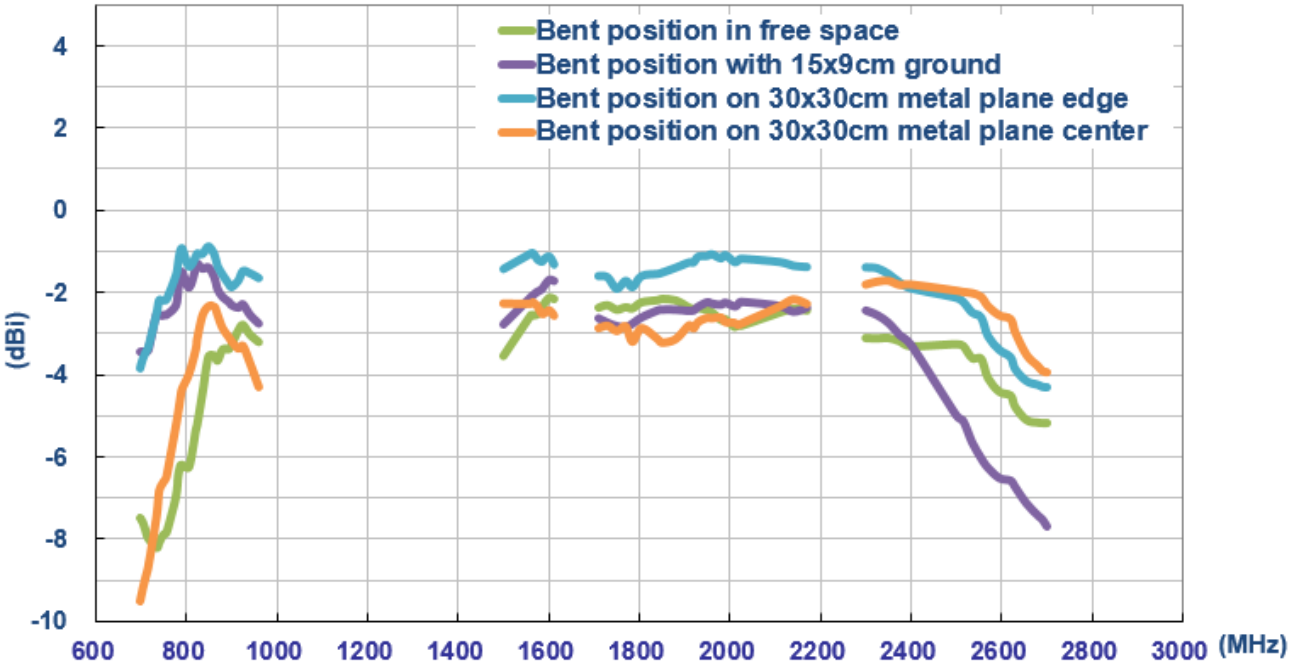


Figure 7. Peak gain of TG.08 antenna in bent position



● Average Gain

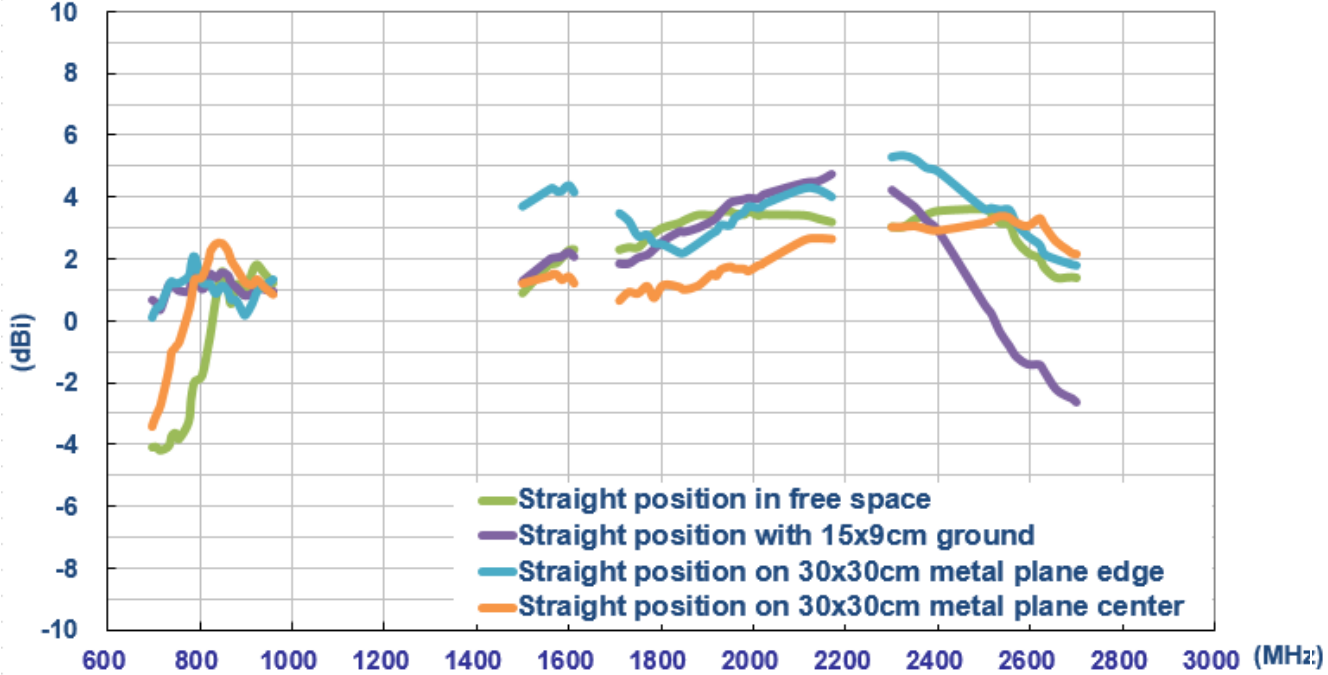


Figure 8. Average gain of TG.08 in straight position

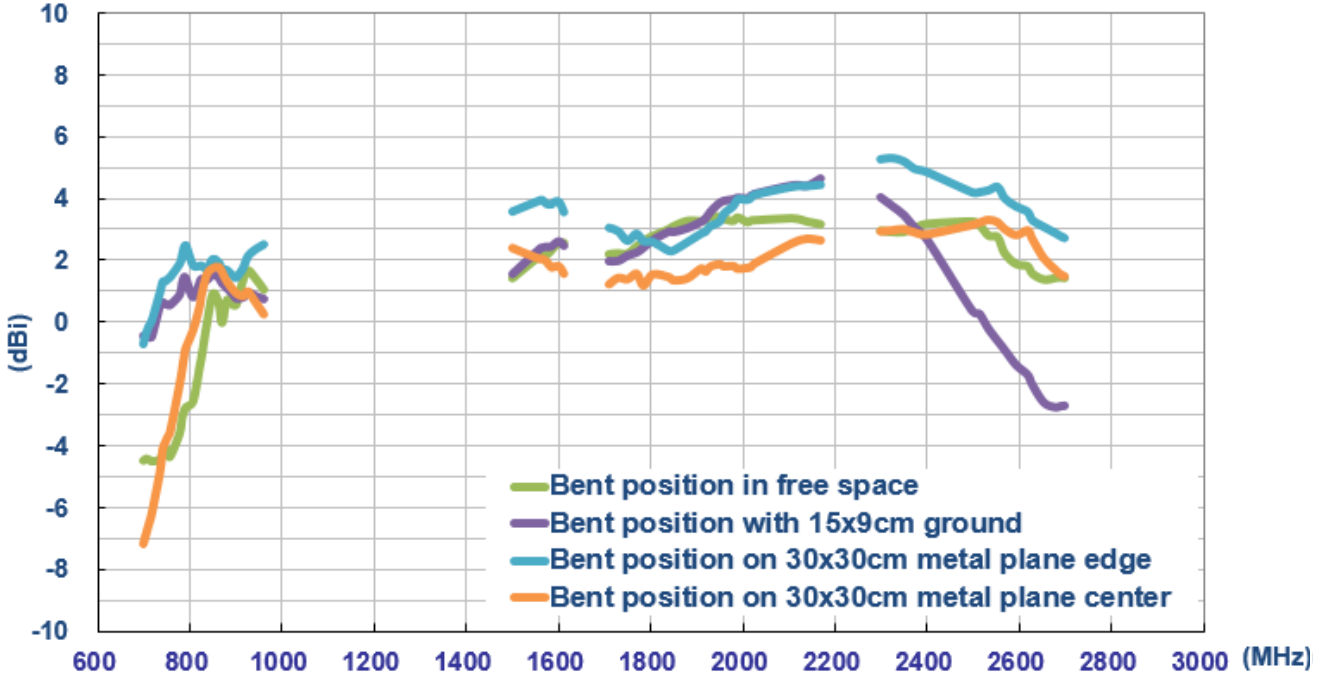
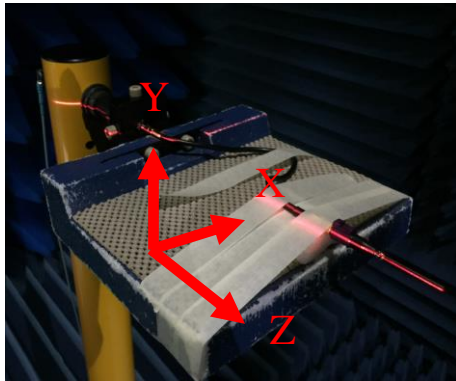


Figure 9. Average gain of TG.08 antenna in bent position

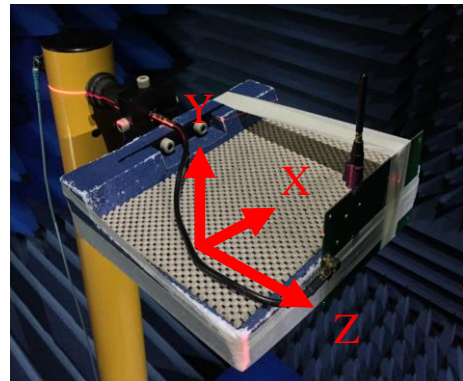
## 2. Antenna Radiation Patterns

The antenna radiation patterns were measured in a CTIA certified ETS Anechoic Chamber. The measurement setups are shown below.

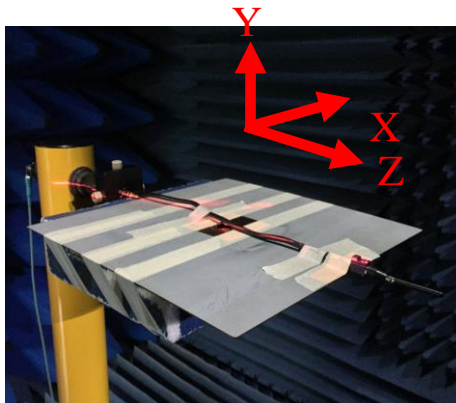
### Antenna with Straight Position



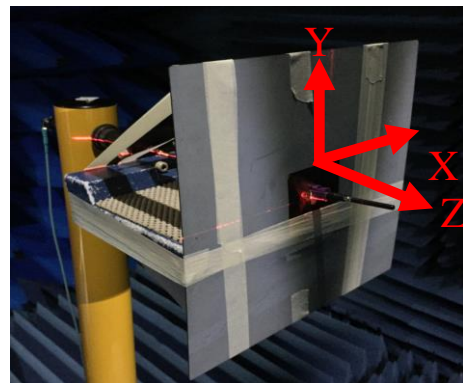
In free space



With 15x9cm ground plane

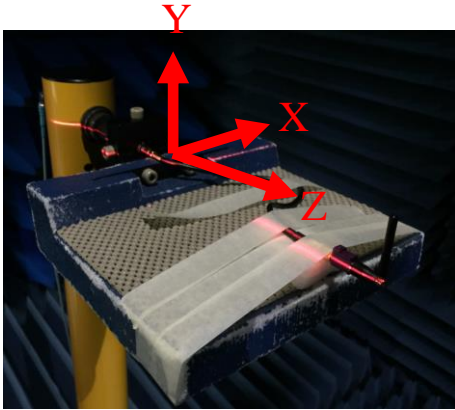


On 30x30cm metal ground edge

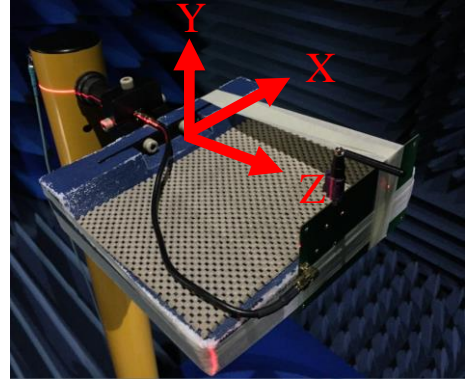


On 30x30cm metal ground center

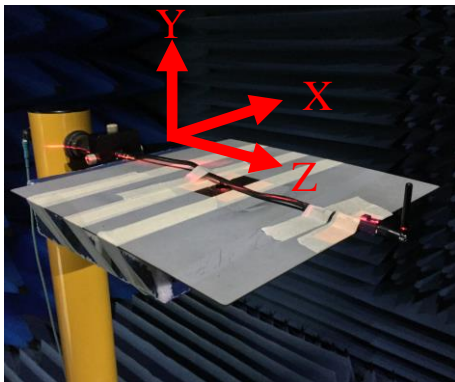
### Antenna Bent Position



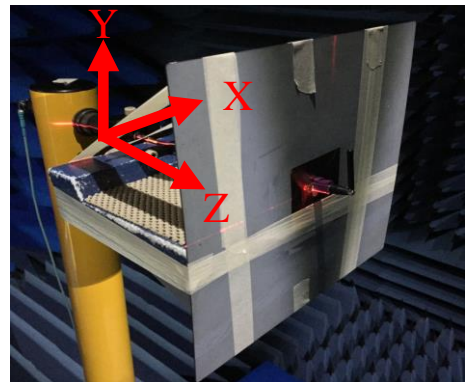
In free space



With 15x9cm ground plane



On 30x30cm metal ground edge

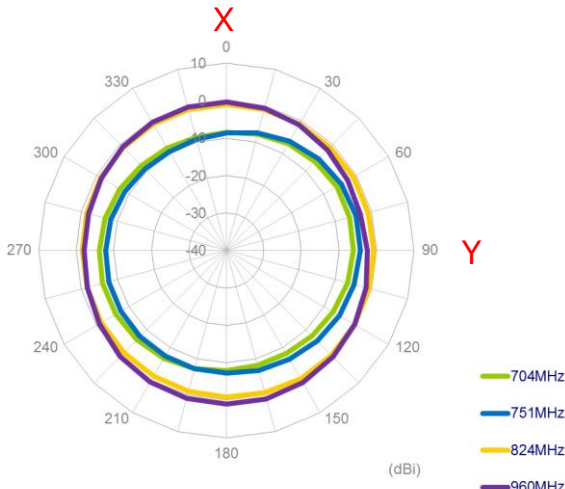


On 30x30cm metal ground center

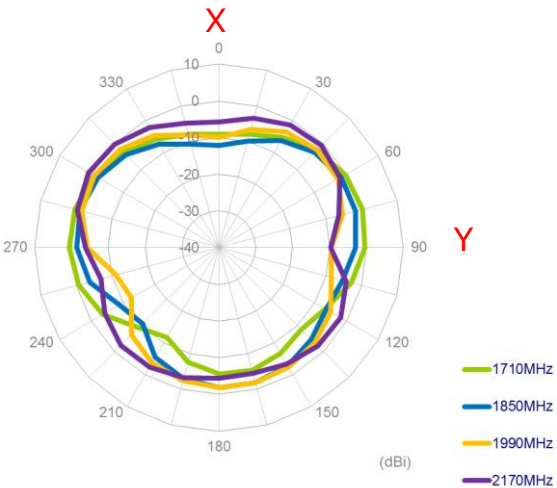
**Figure 10.** Testing Setup in ETS Anechoic Chamber

**2D Radiation Pattern  
(Straight Position in Free Space)**

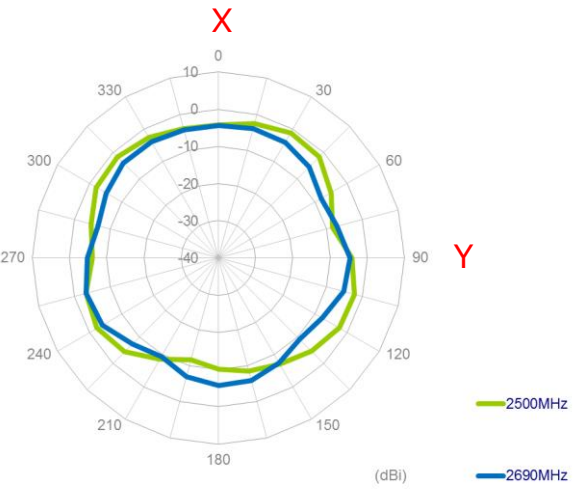
XY Plane



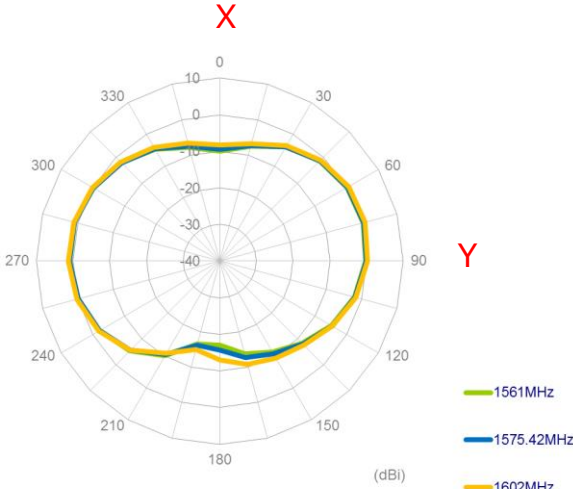
XY Plane



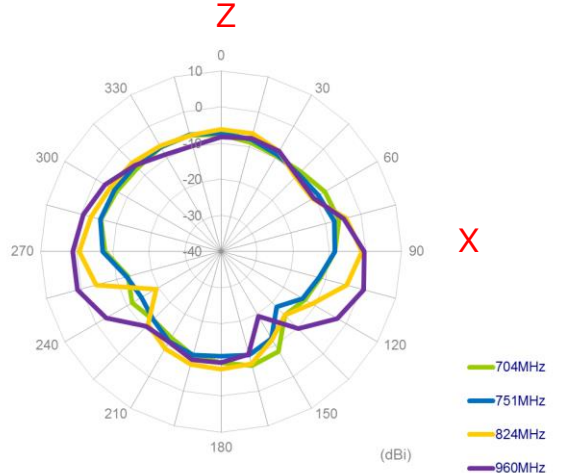
XY Plane



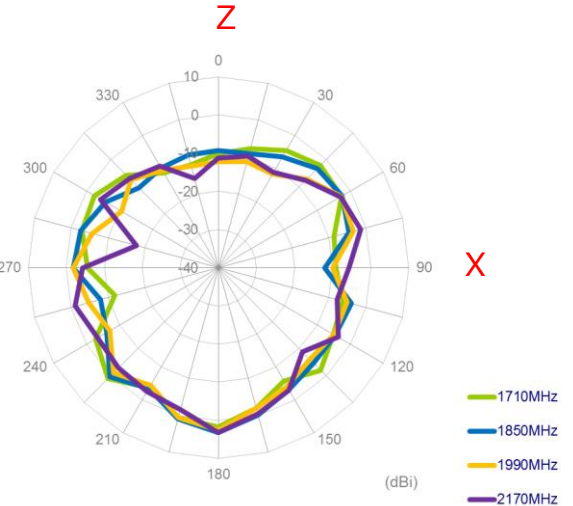
XY Plane



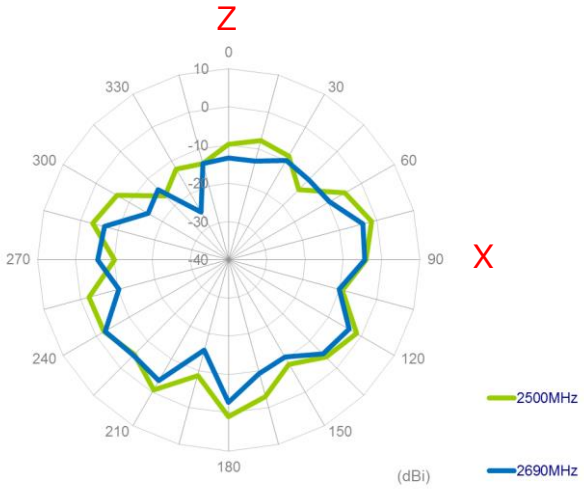
XZ Plane



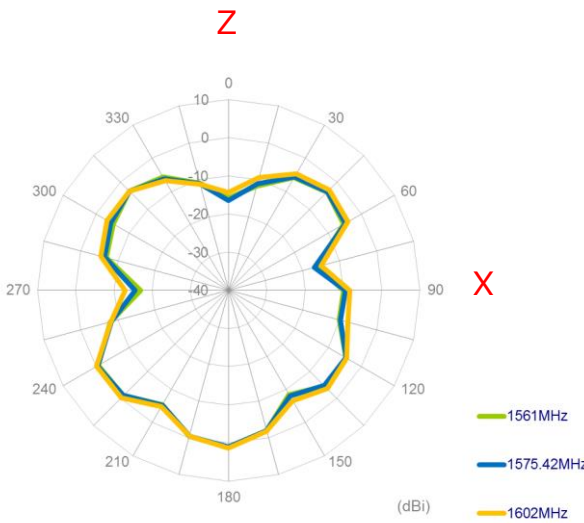
XZ Plane



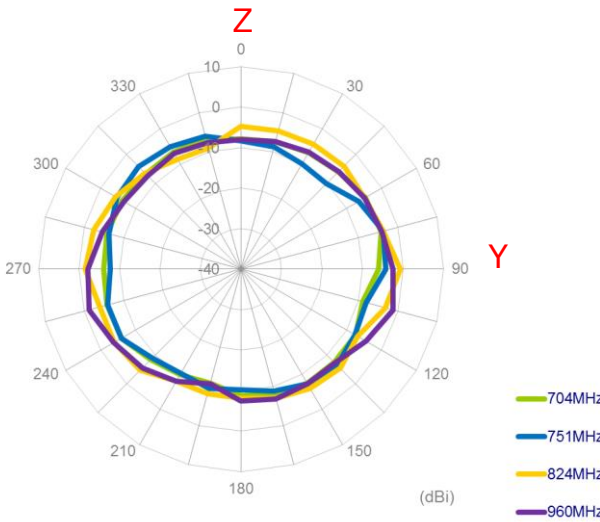
XZ Plane



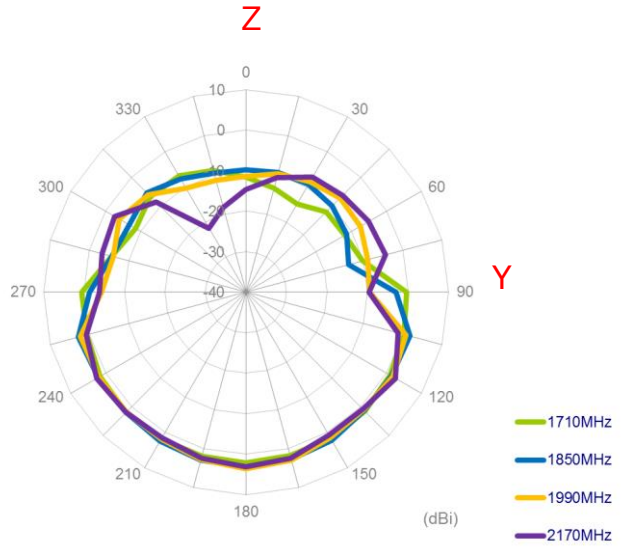
XZ Plane



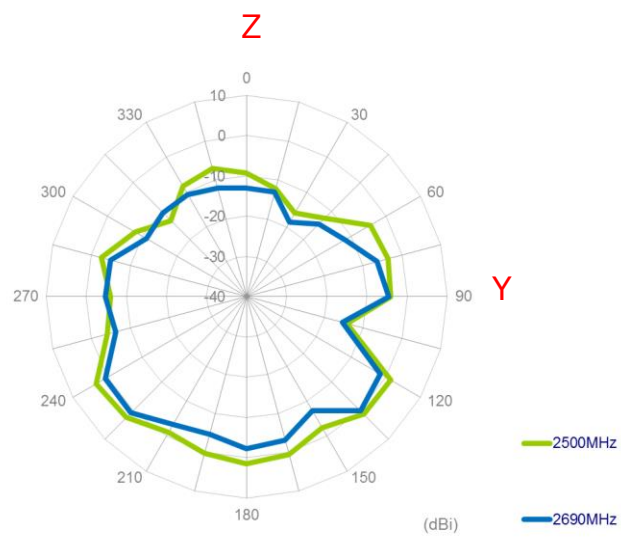
YZ Plane



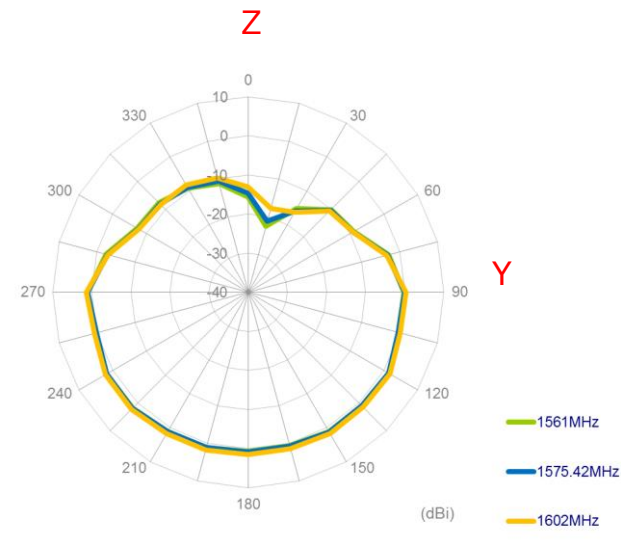
YZ Plane



YZ Plane

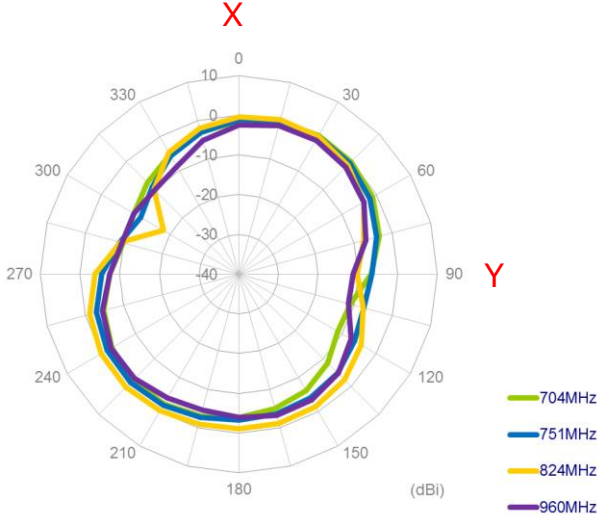


YZ Plane

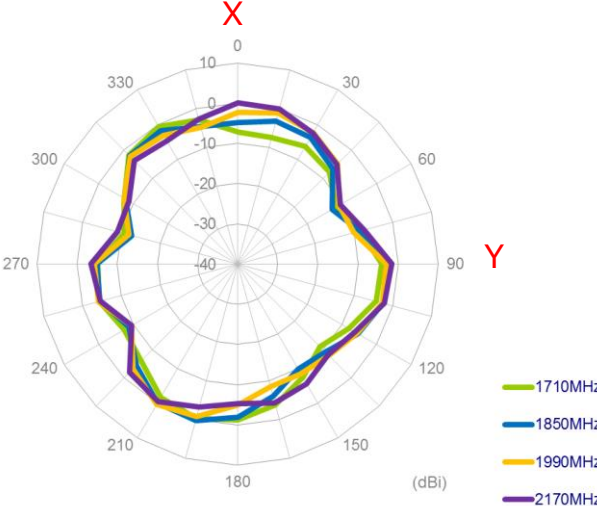


**2D Radiation Pattern  
(Straight Position with 15x9cm Ground)**

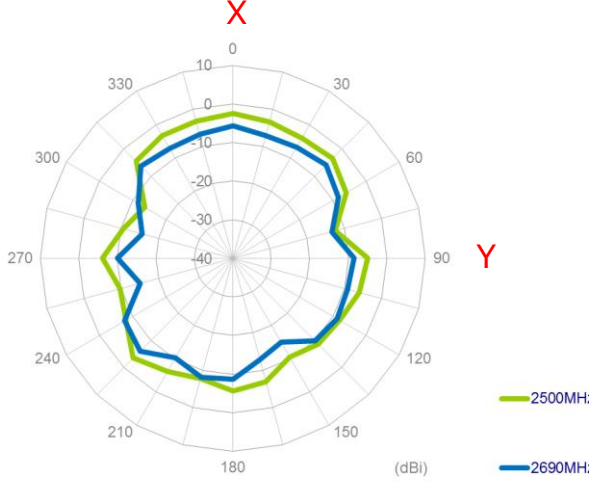
XY Plane



XY Plane

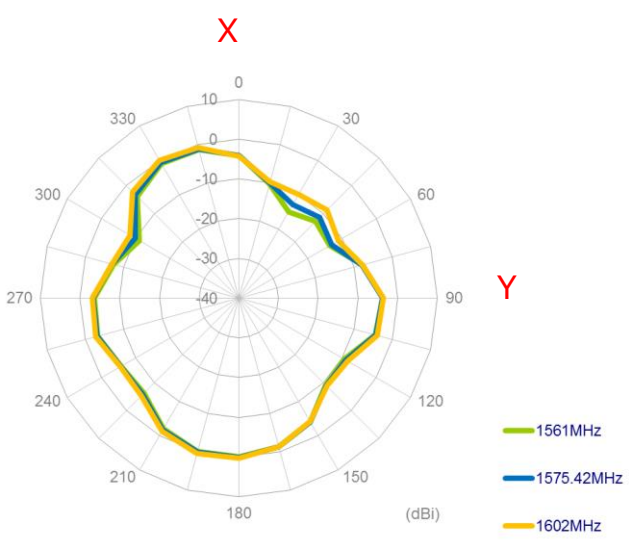


XY Plane

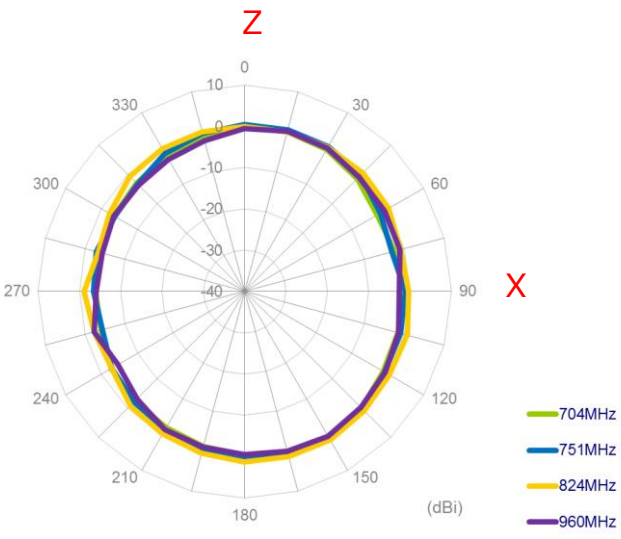




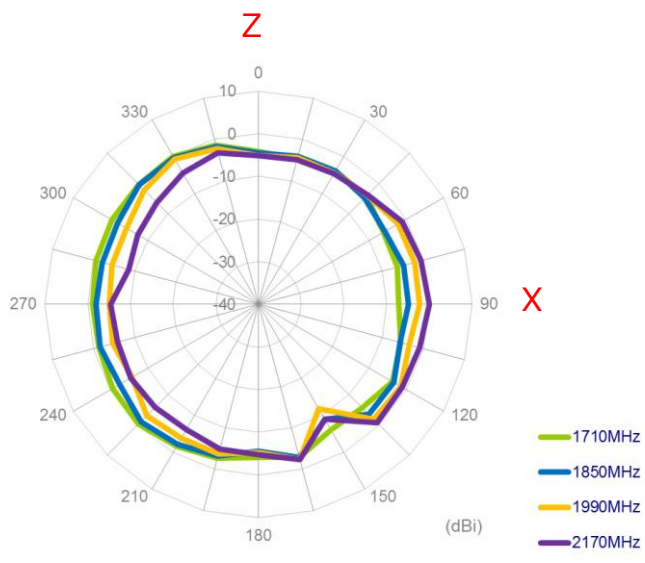
XY Plane



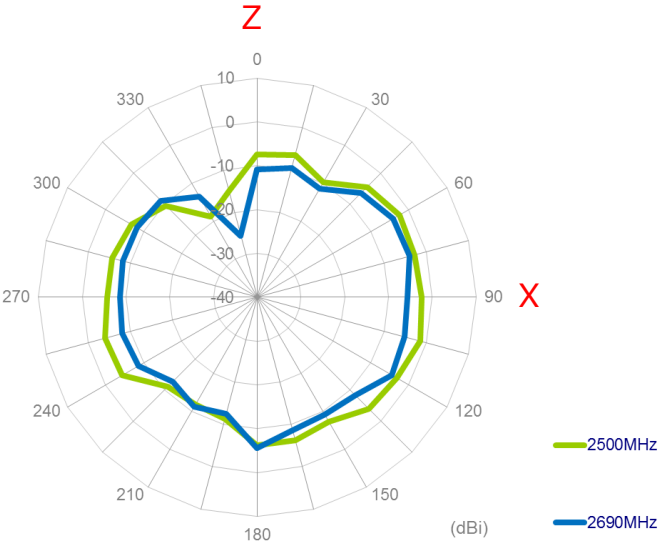
XZ Plane



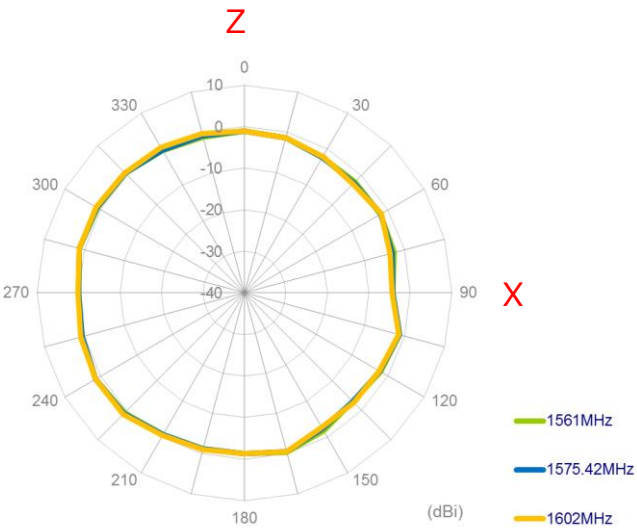
XZ Plane



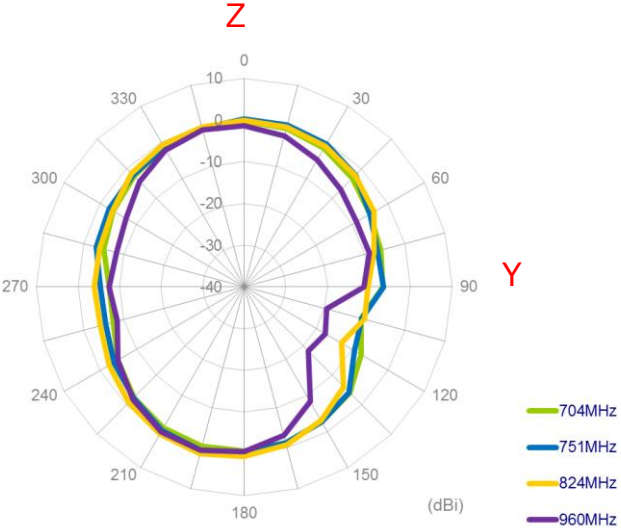
XZ Plane



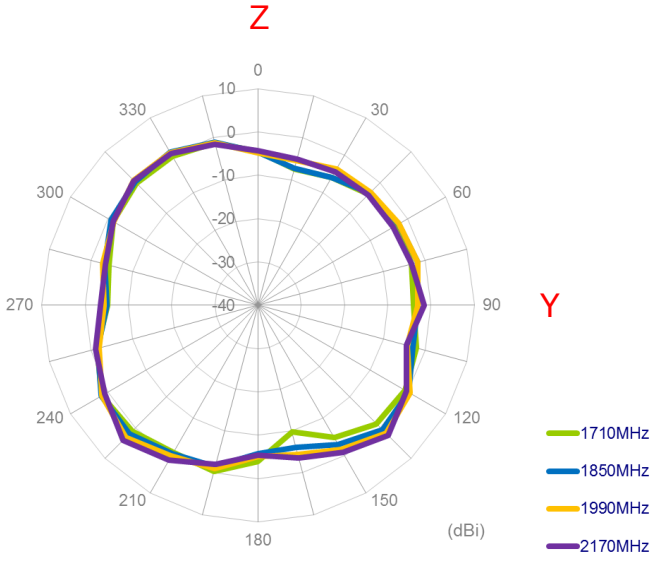
XZ Plane



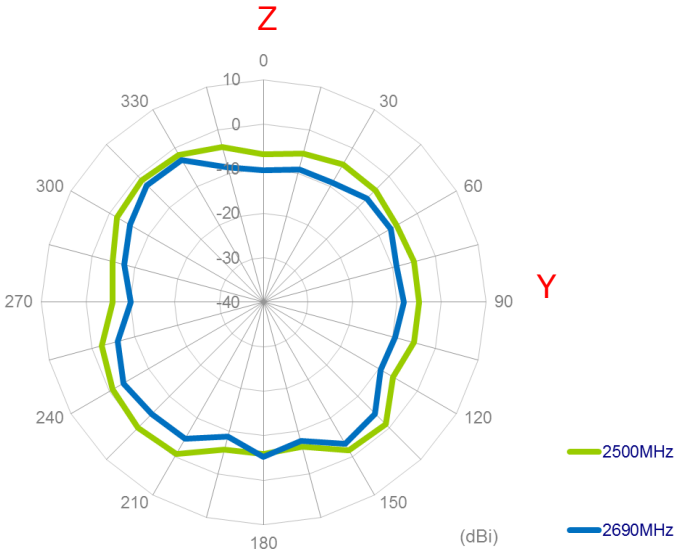
YZ Plane



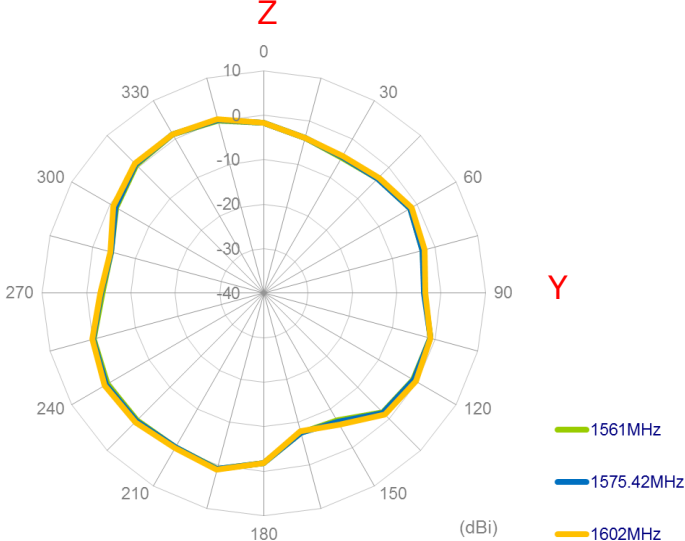
YZ Plane



YZ Plane

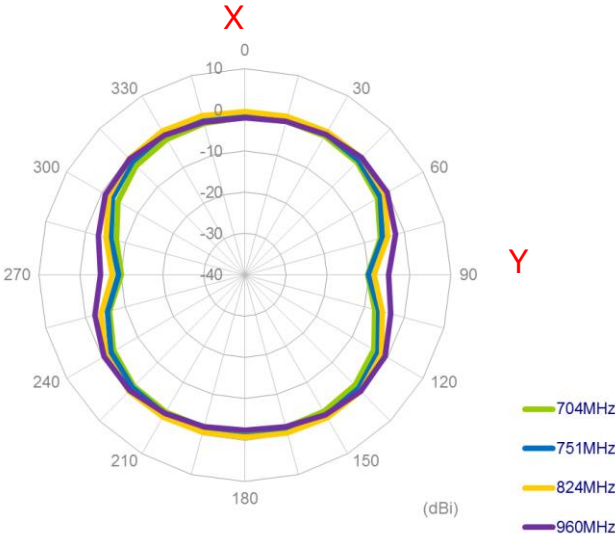


YZ Plane

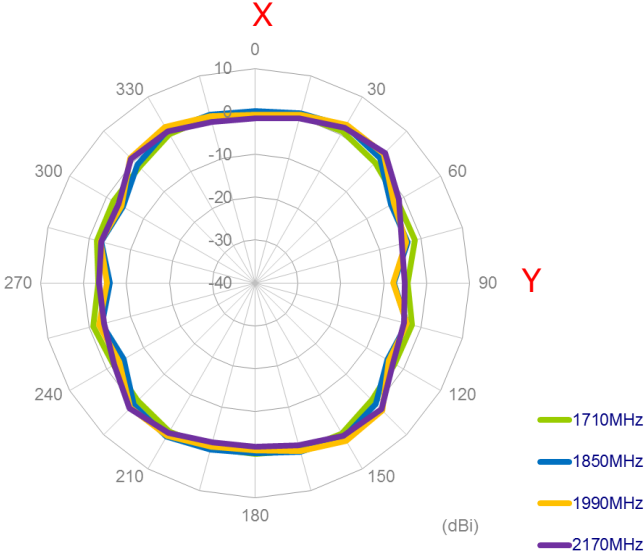


**2D Radiation Pattern  
(Straight Position with 30x30cm Metal Ground Edge)**

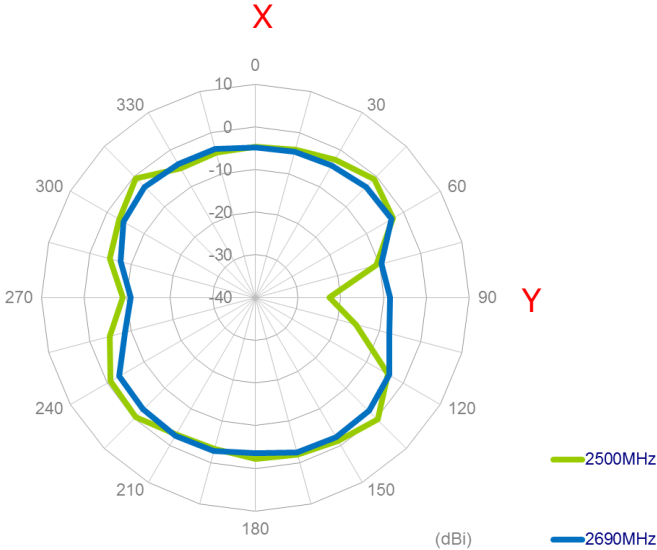
XY Plane



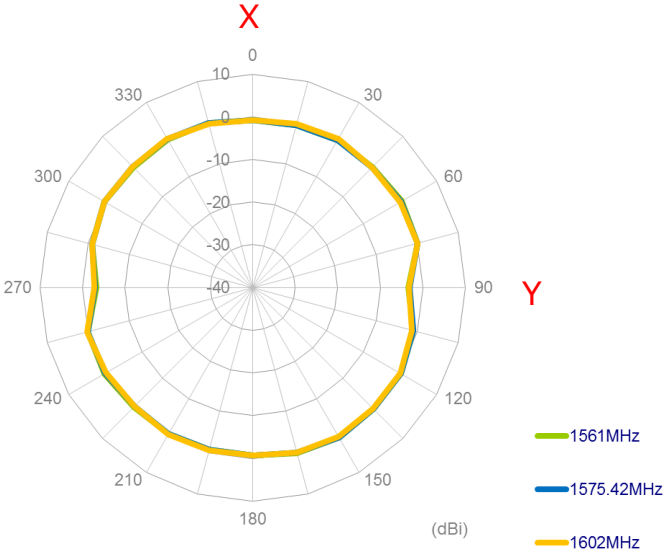
XY Plane



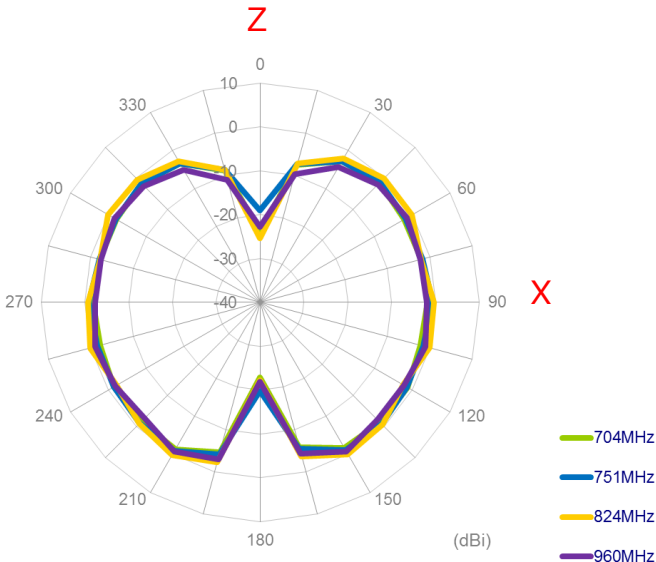
XY Plane



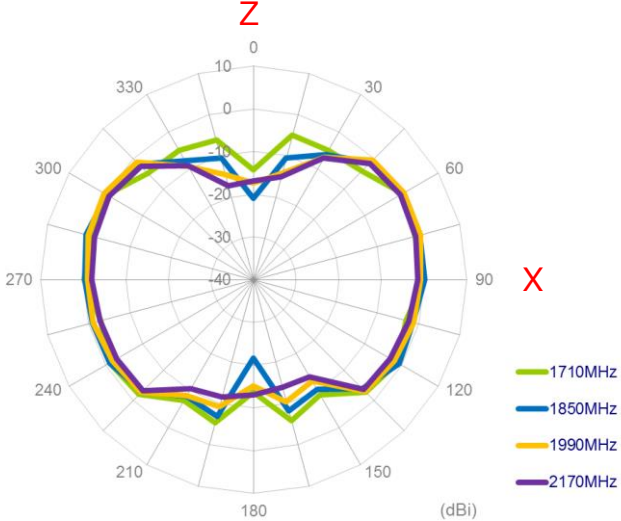
XY Plane



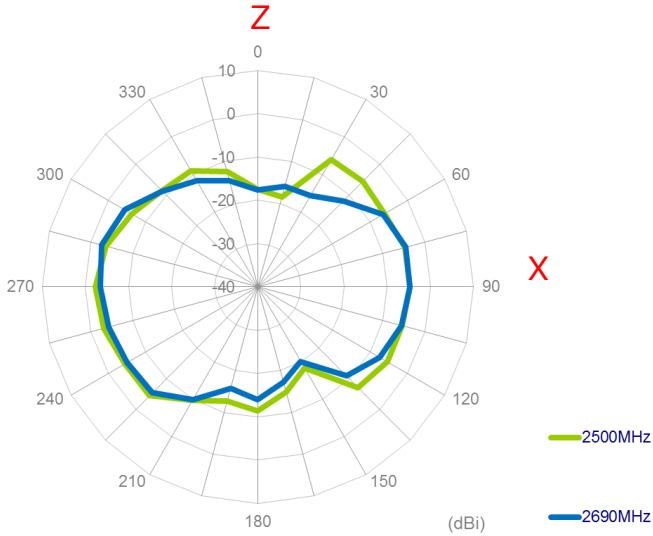
XZ Plane



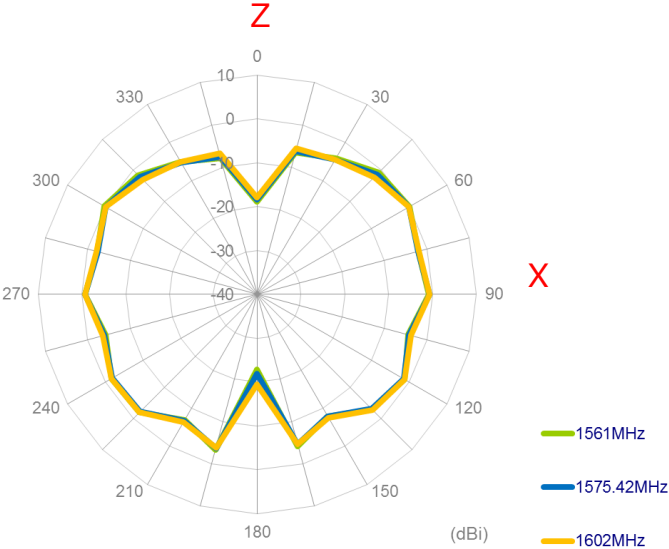
XZ Plane



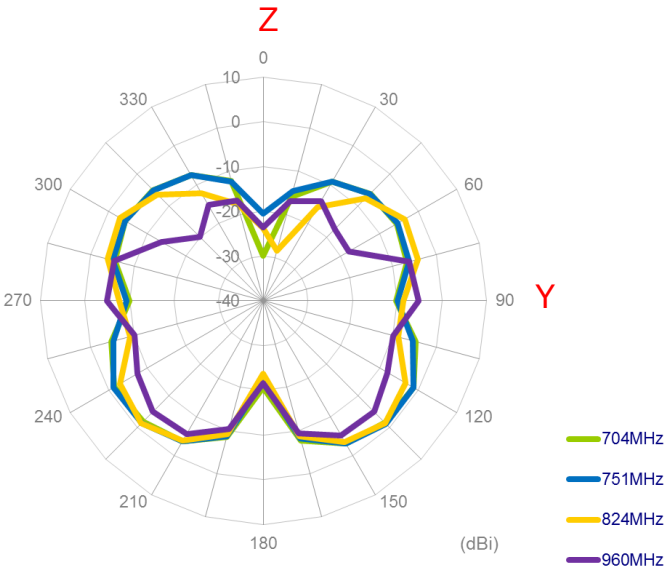
XZ Plane



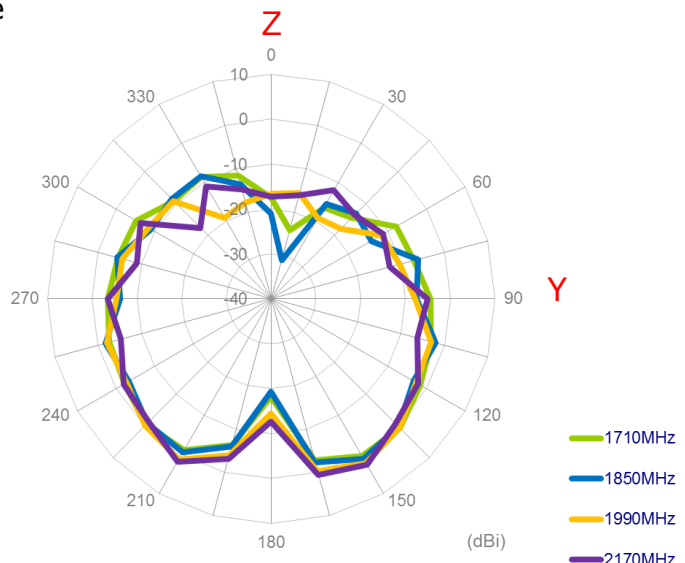
XZ Plane



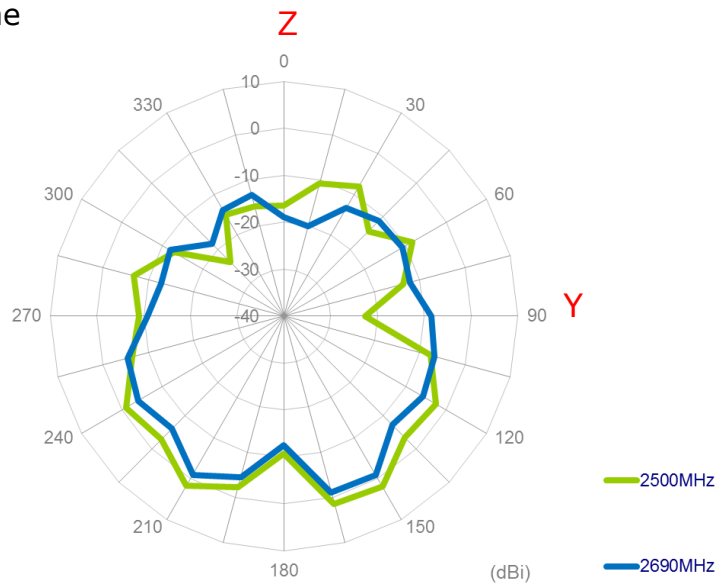
YZ Plane



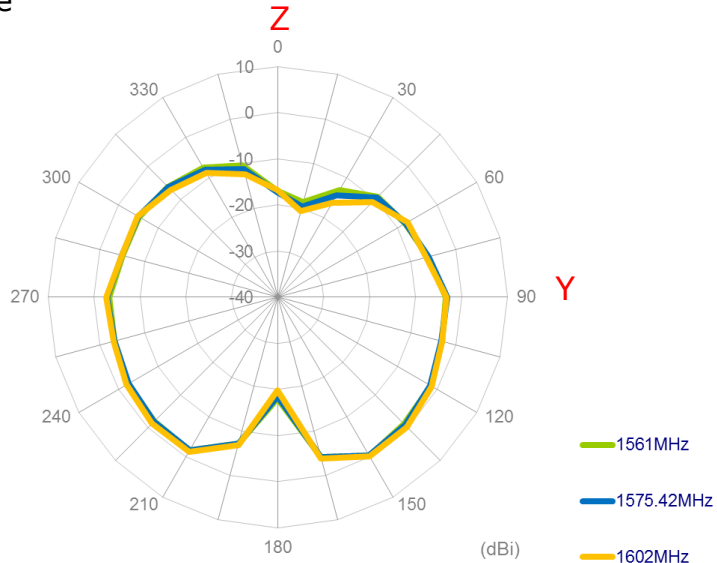
YZ Plane



YZ Plane



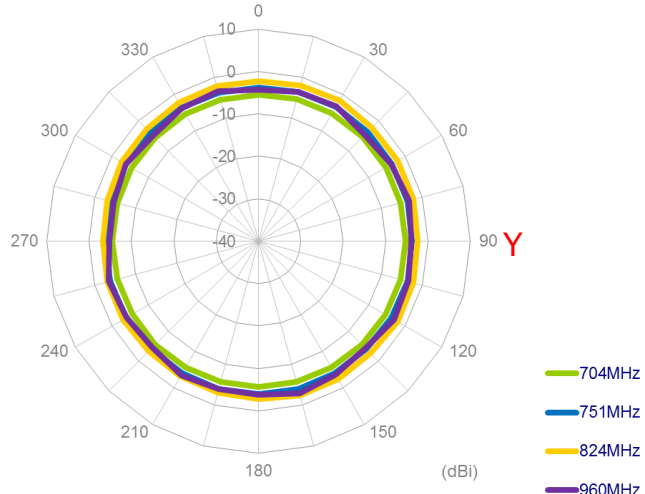
YZ Plane



**2D Radiation Pattern  
(Straight Position with 30x30cm Metal Ground Center)**

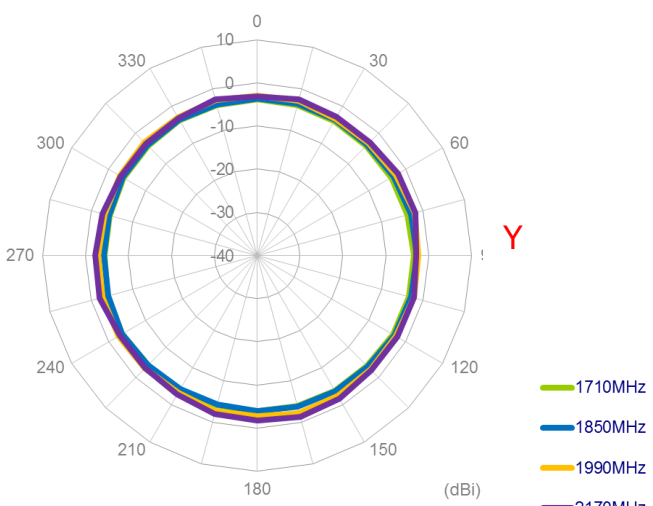
X

XY Plane



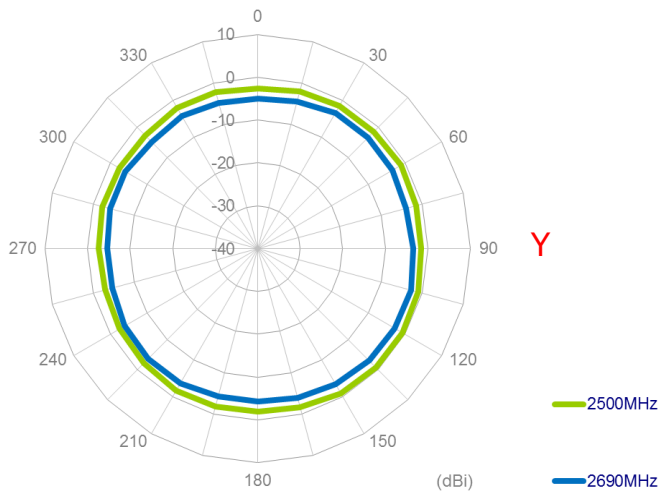
XY Plane

X



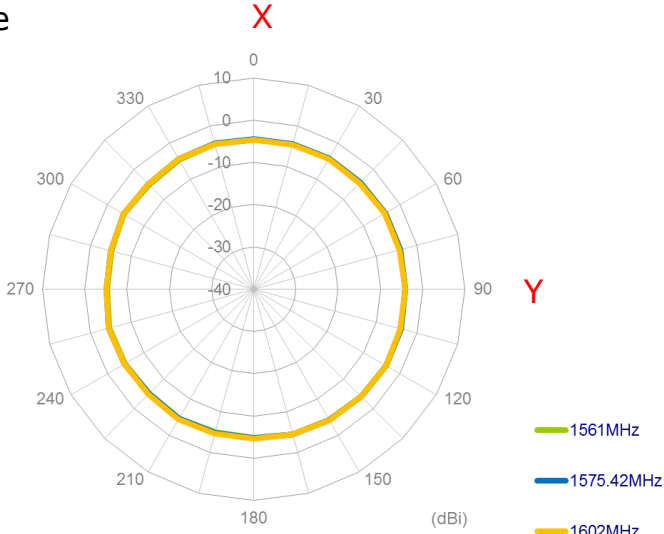
XY Plane

X

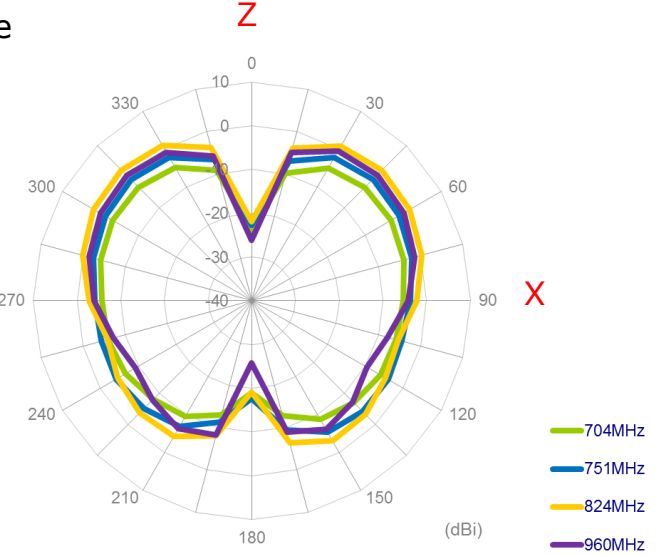




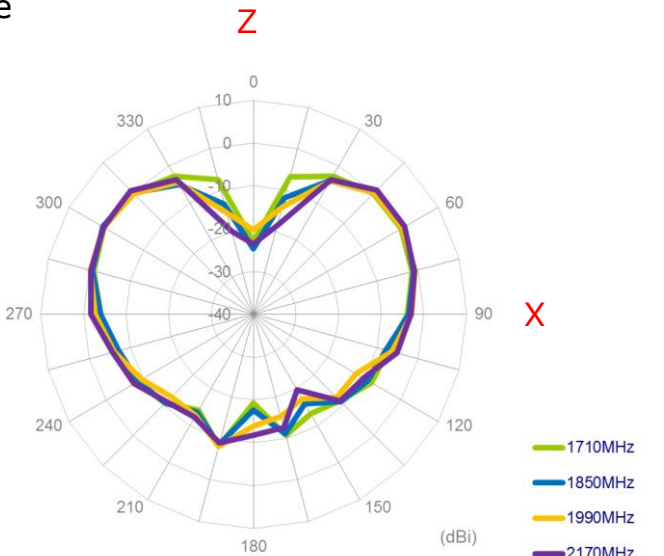
XY Plane



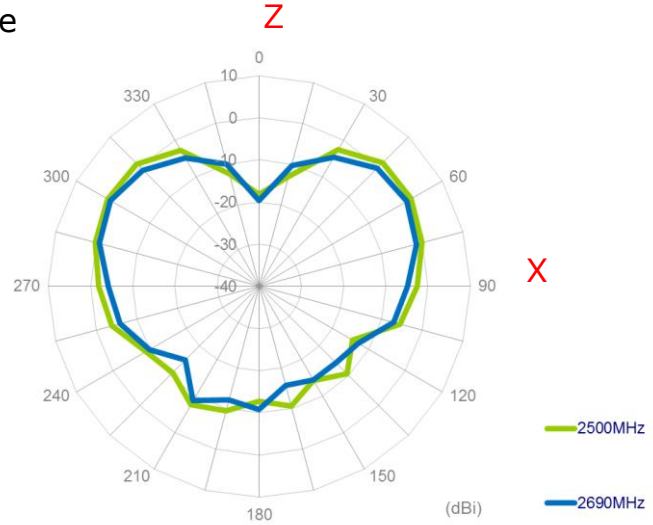
XZ Plane



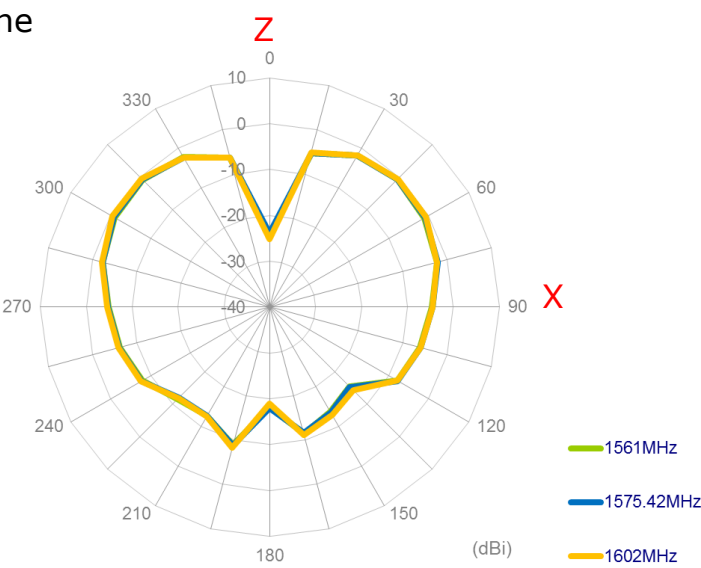
XZ Plane



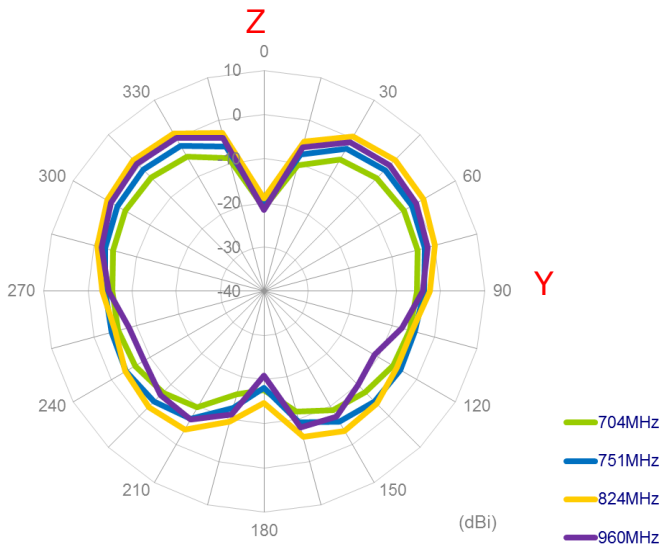
XZ Plane



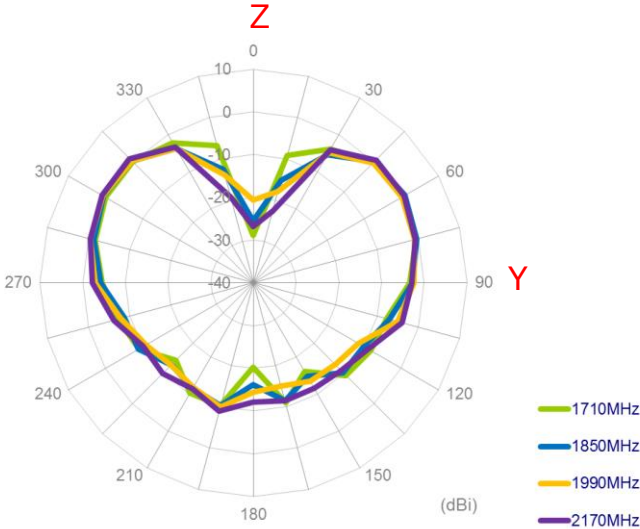
XZ Plane



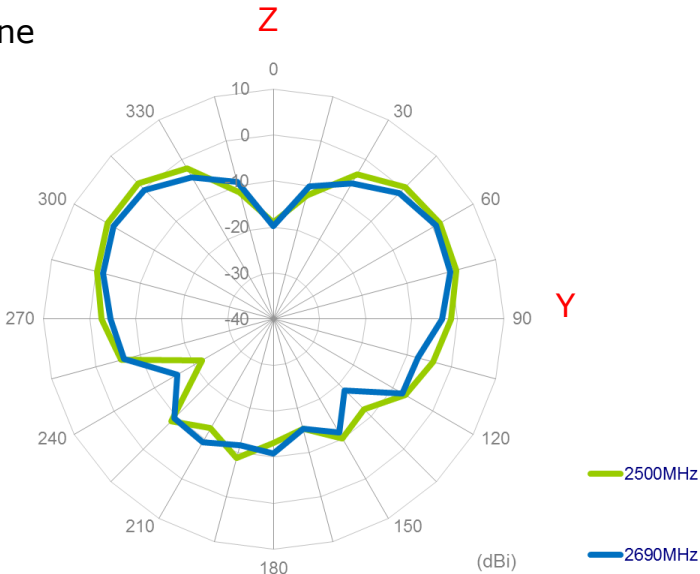
YZ Plane



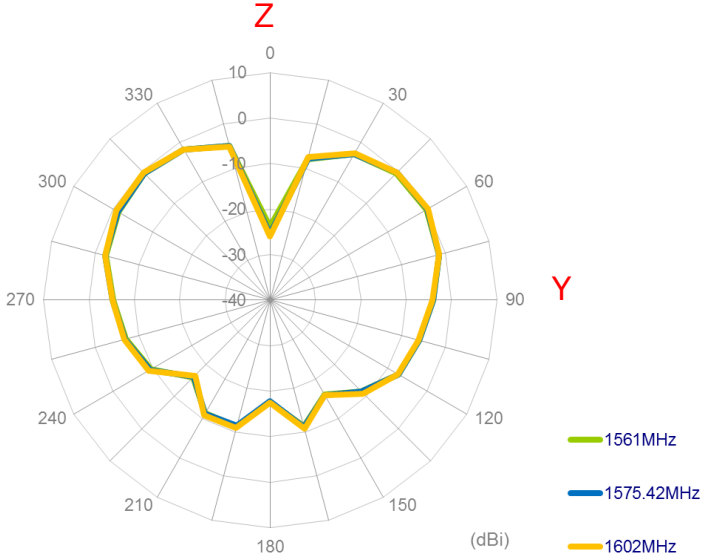
YZ Plane



YZ Plane

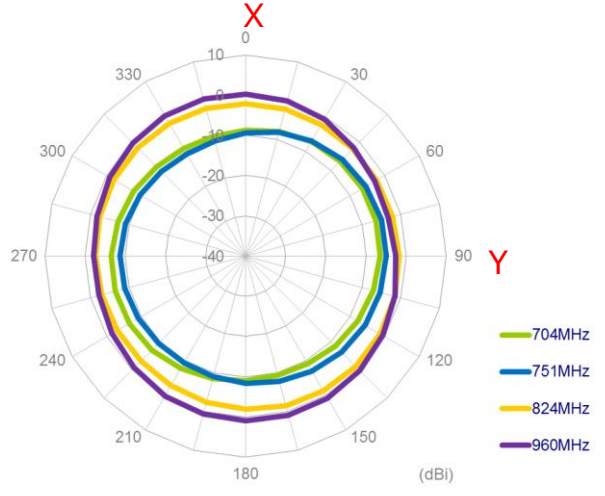


YZ Plane

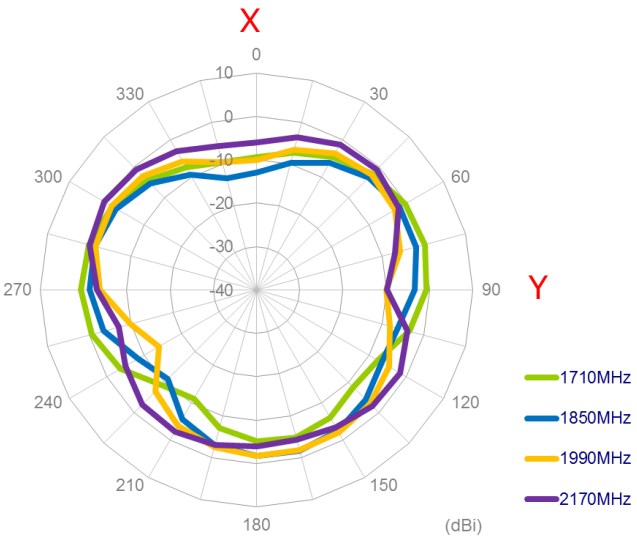


**2D Radiation Pattern  
(Bent Position in Free Space)**

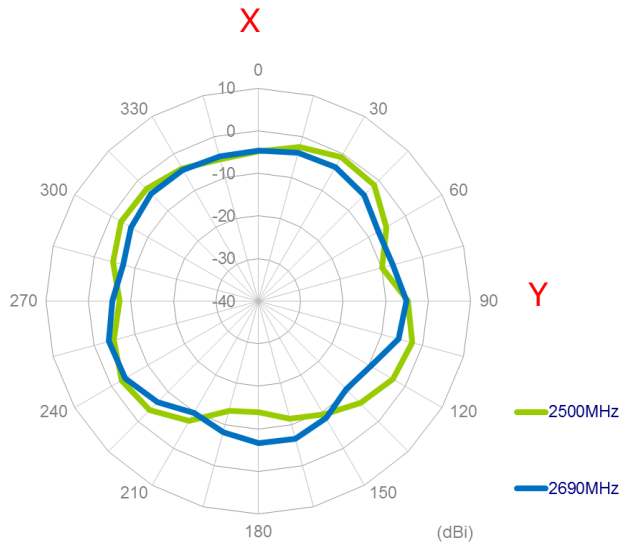
XY Plane



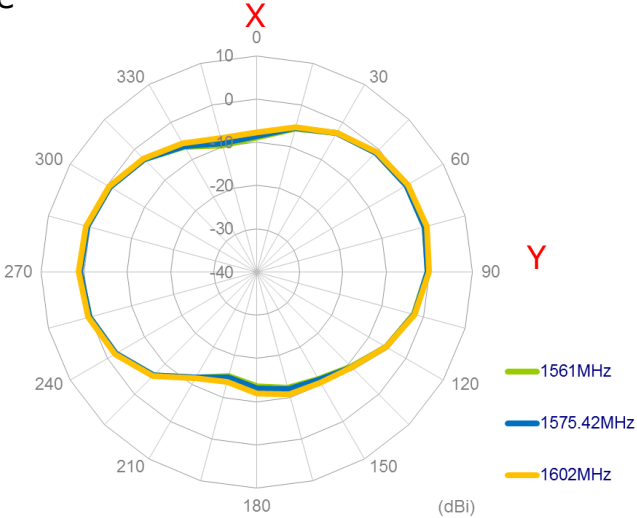
XY Plane



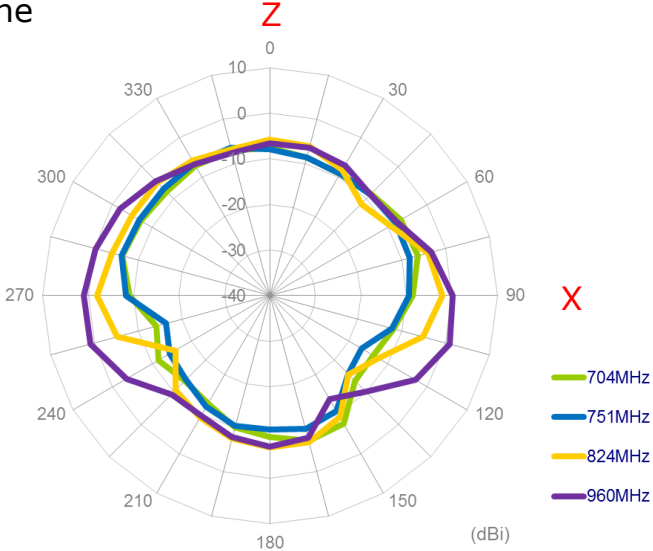
XY Plane



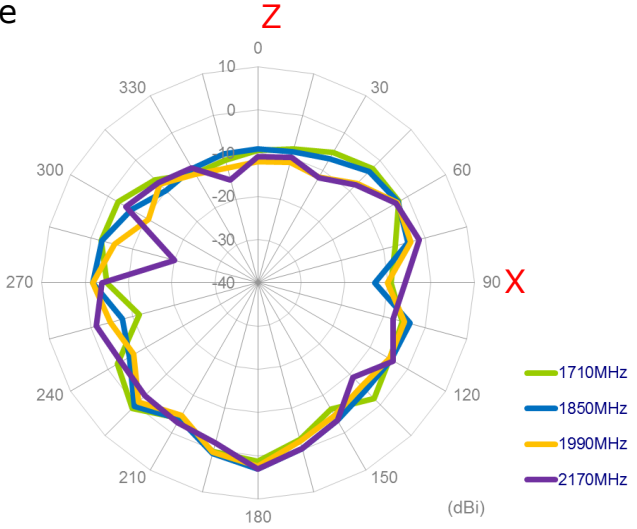
XY Plane



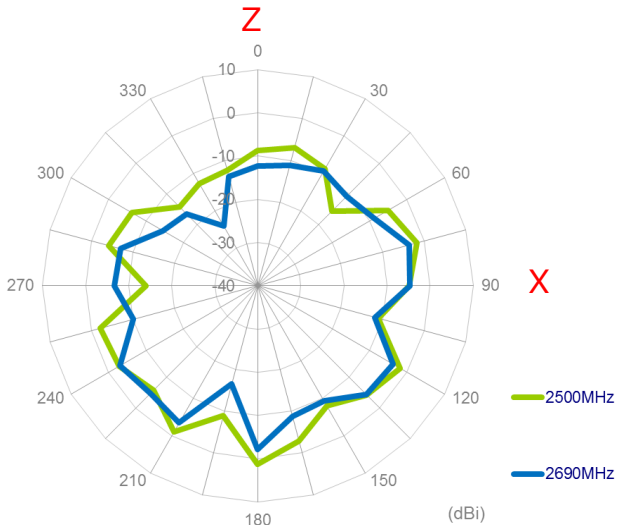
XZ Plane



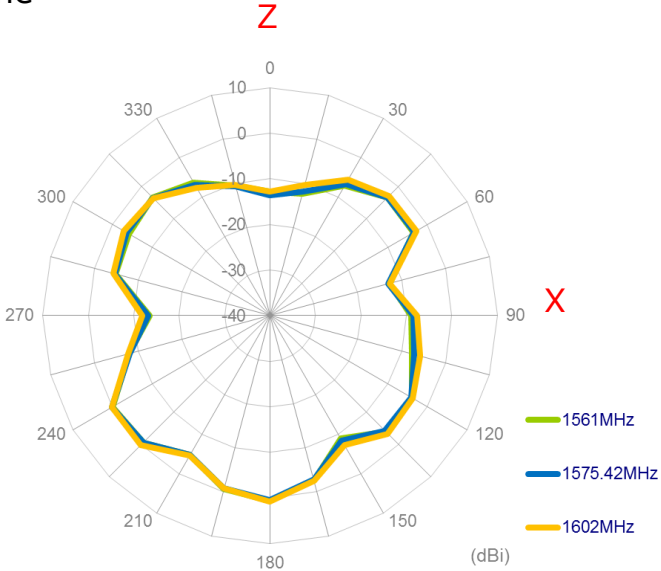
XZ Plane



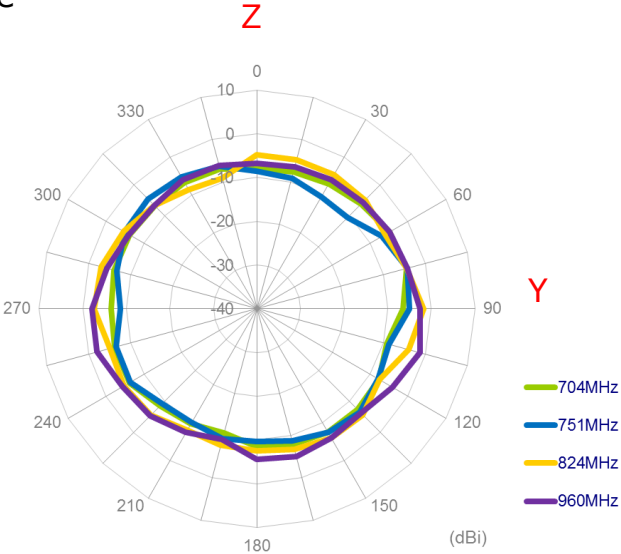
XZ Plane



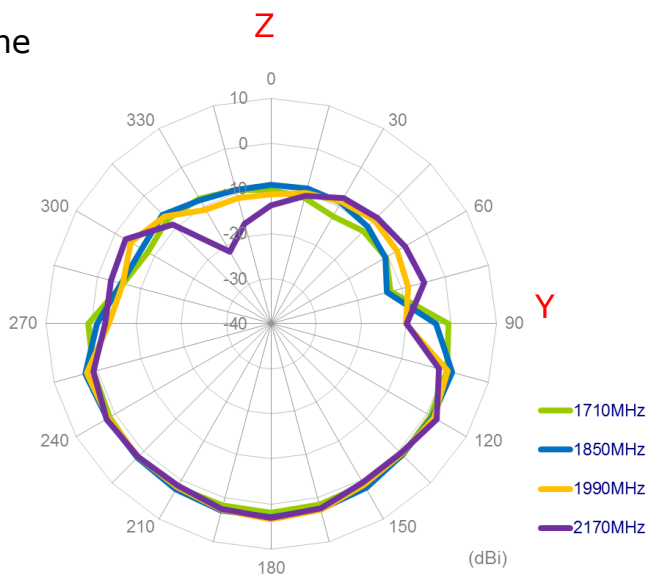
XZ Plane



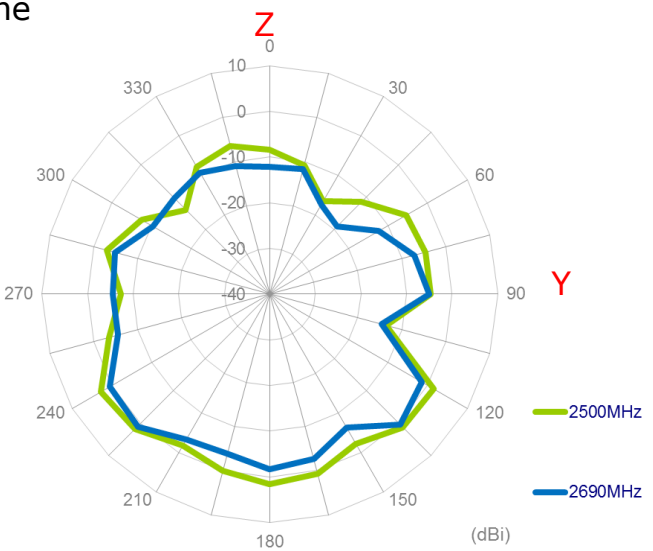
YZ Plane



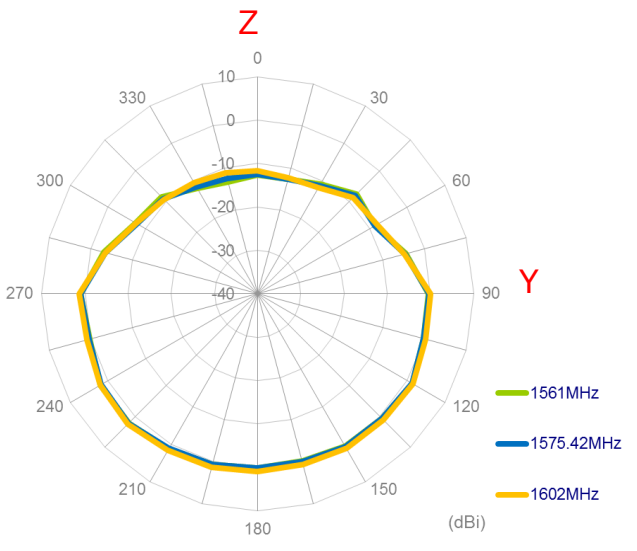
YZ Plane



YZ Plane

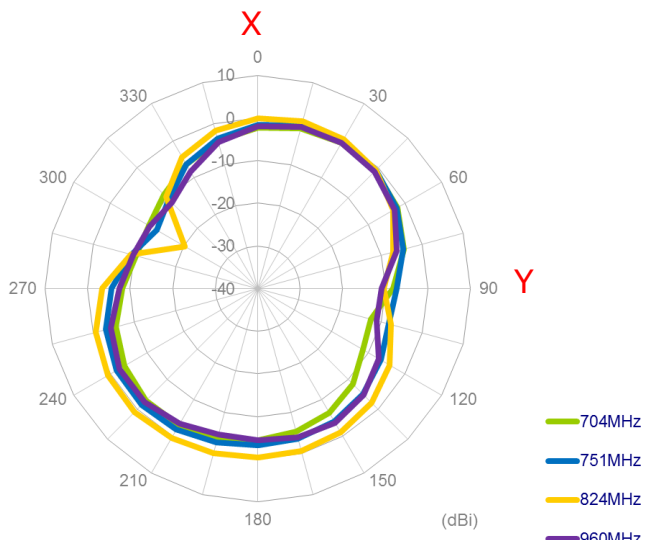


YZ Plane

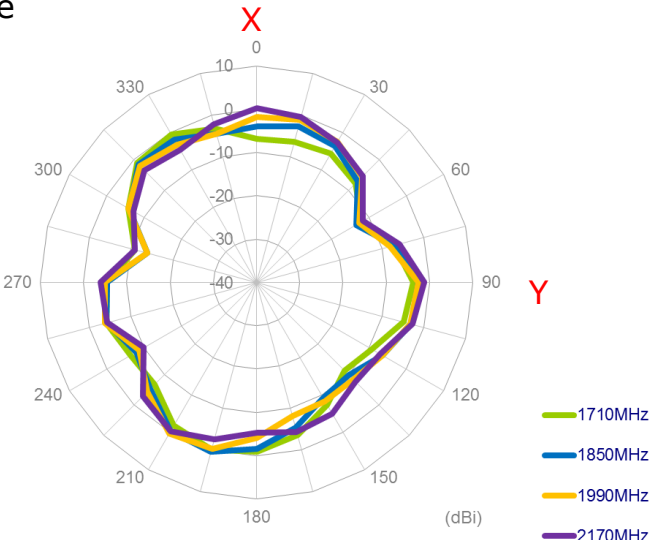


**2D Radiation Pattern  
(Bent Position with 15x9cm Ground )**

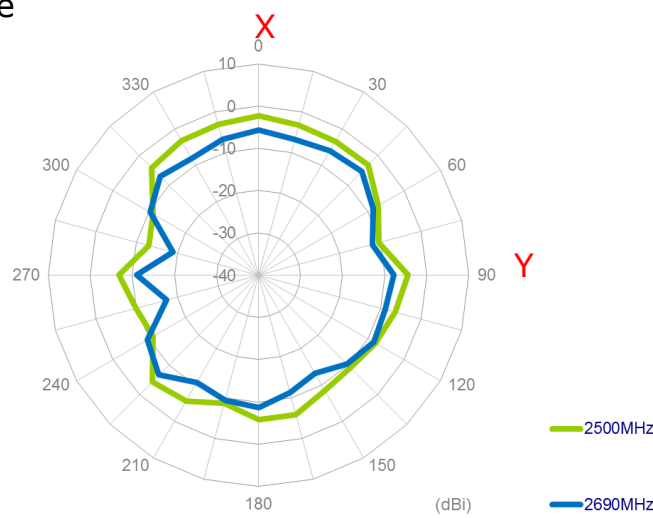
XY Plane



XY Plane

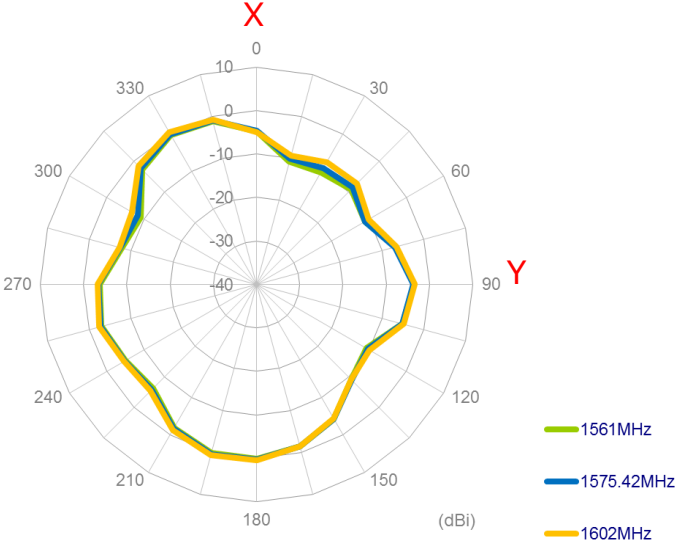


XY Plane

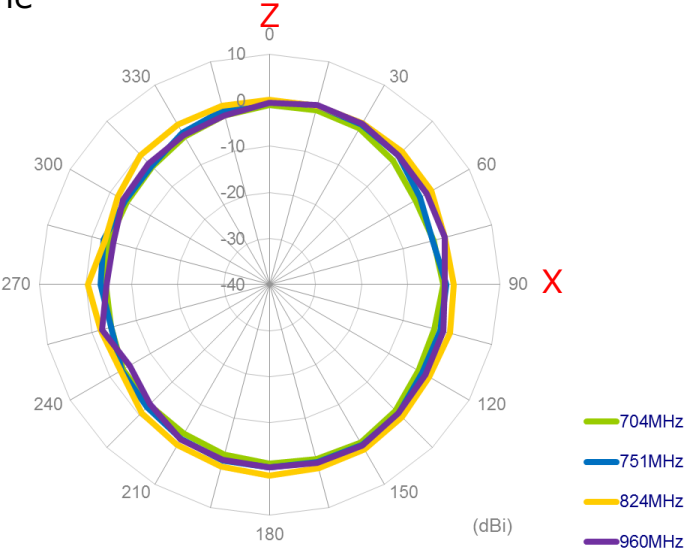




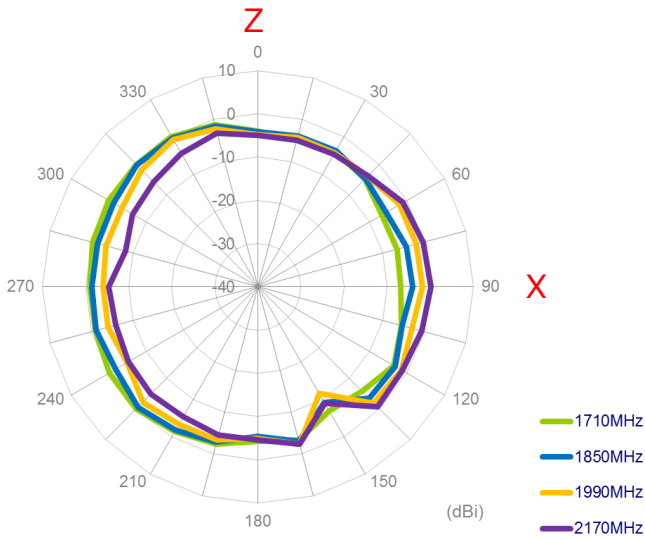
XY Plane



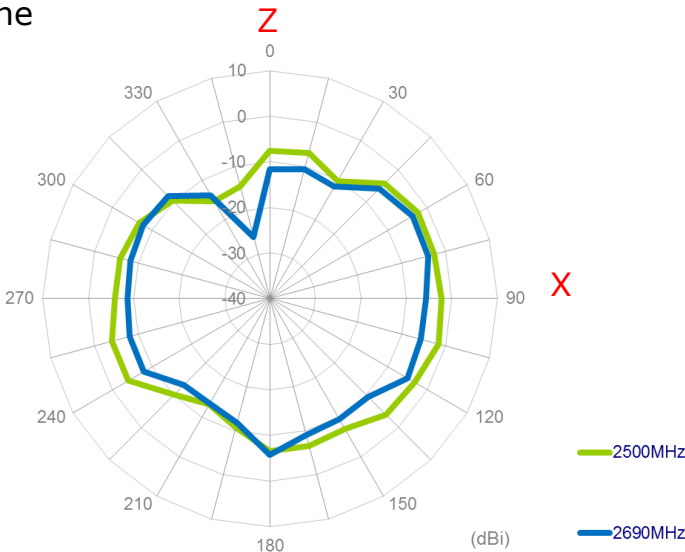
XZ Plane



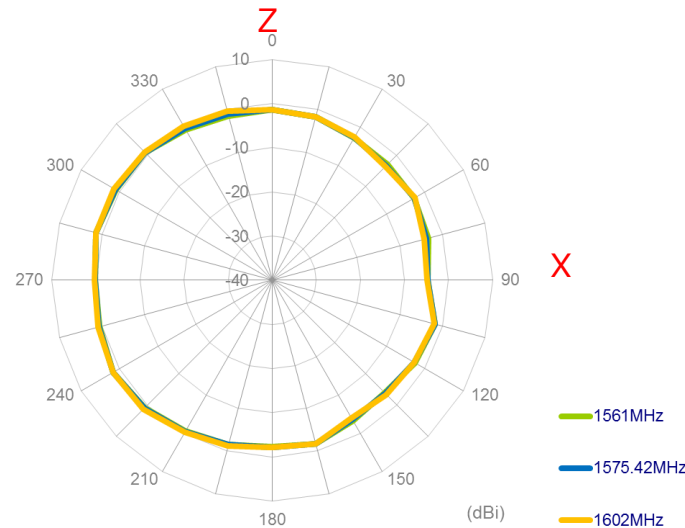
XZ Plane



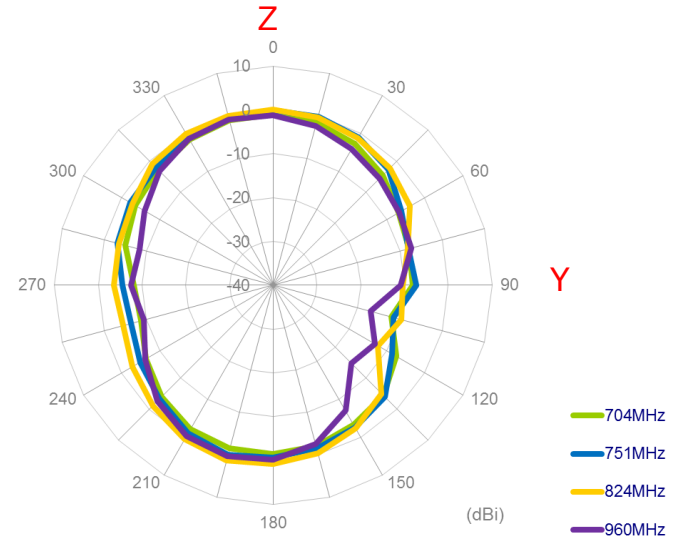
XZ Plane



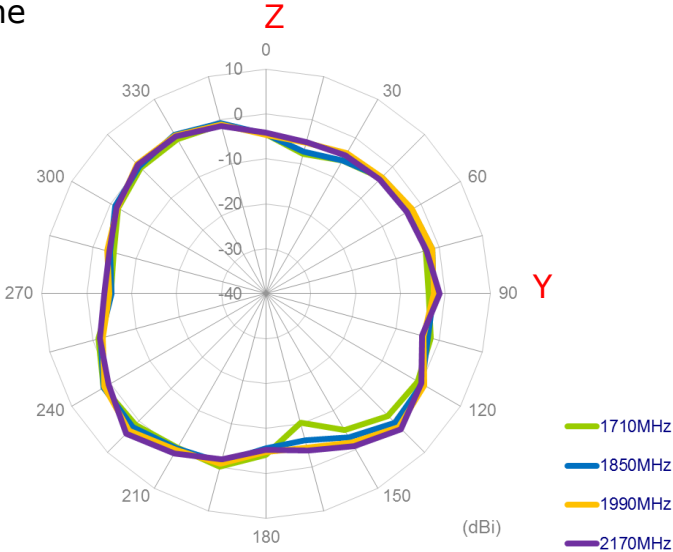
XZ Plane



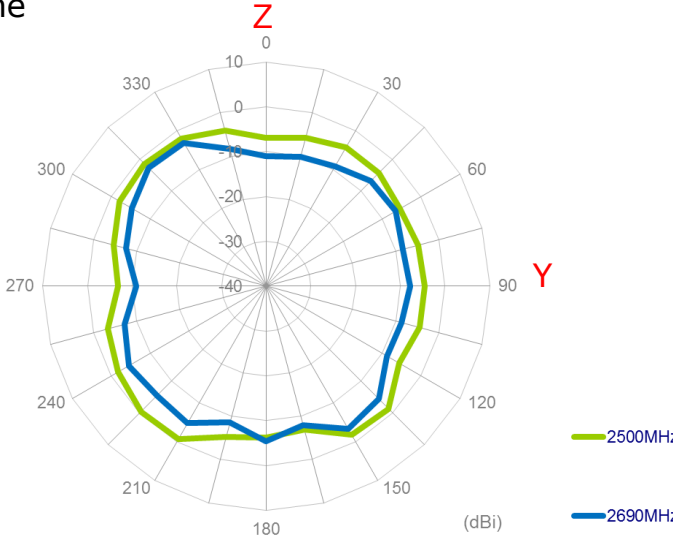
YZ Plane



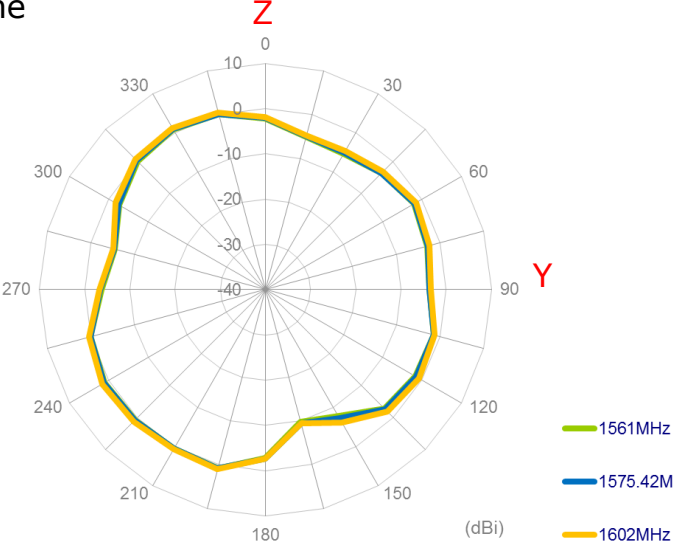
YZ Plane



YZ Plane

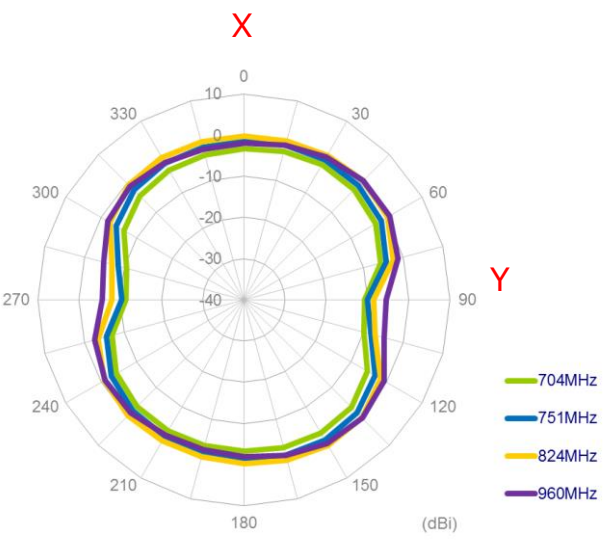


YZ Plane

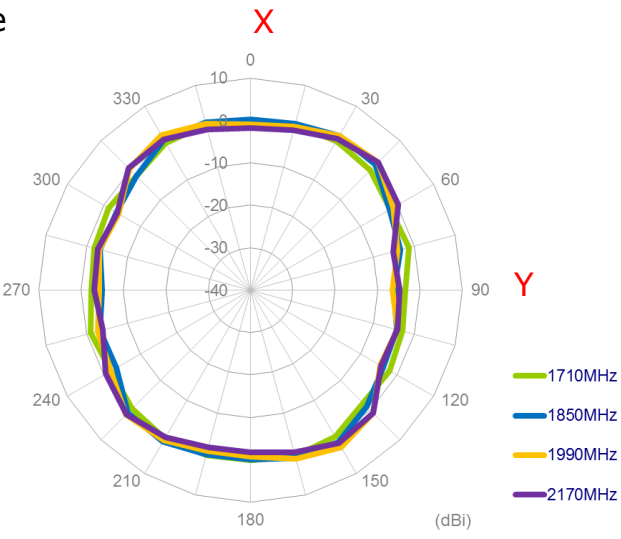


**2D Radiation Pattern  
(Bent Position with 30x30cm Metal Ground Edge)**

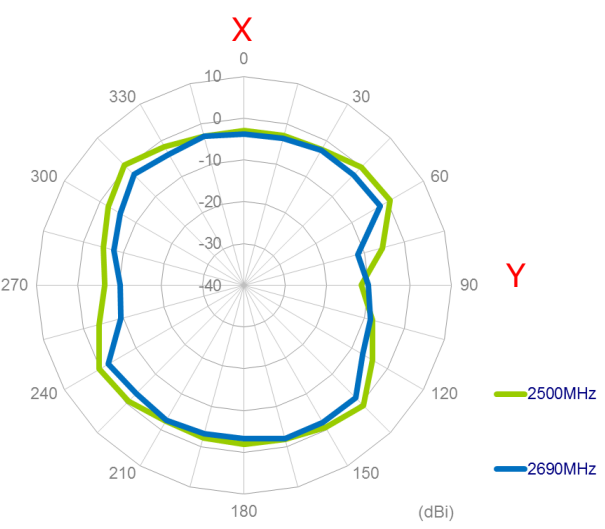
XY Plane



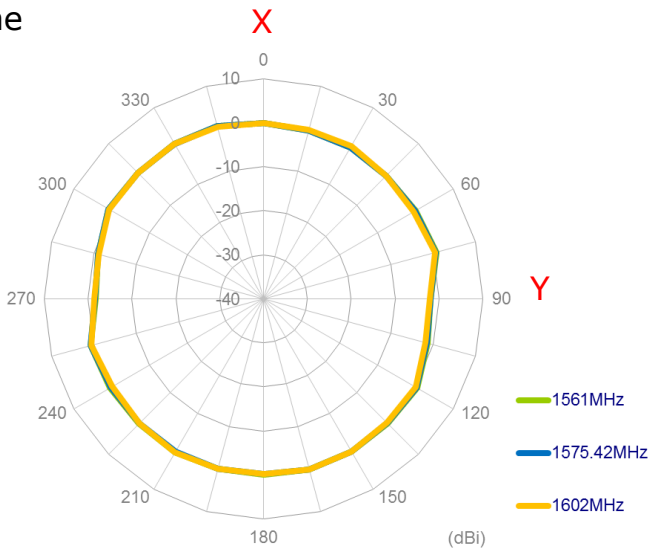
XY Plane



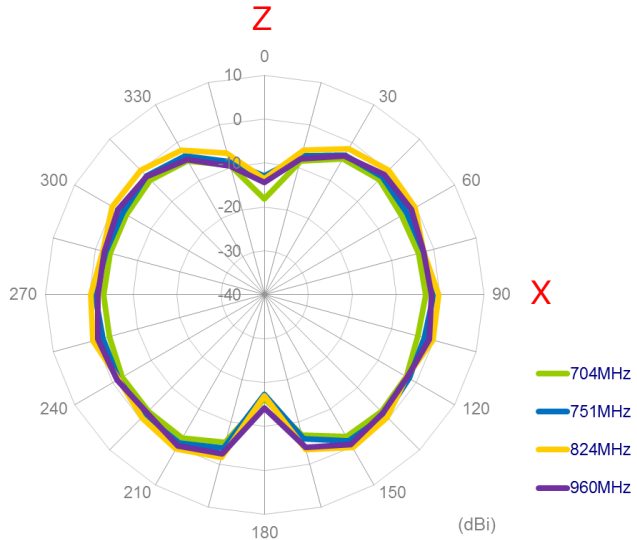
XY Plane



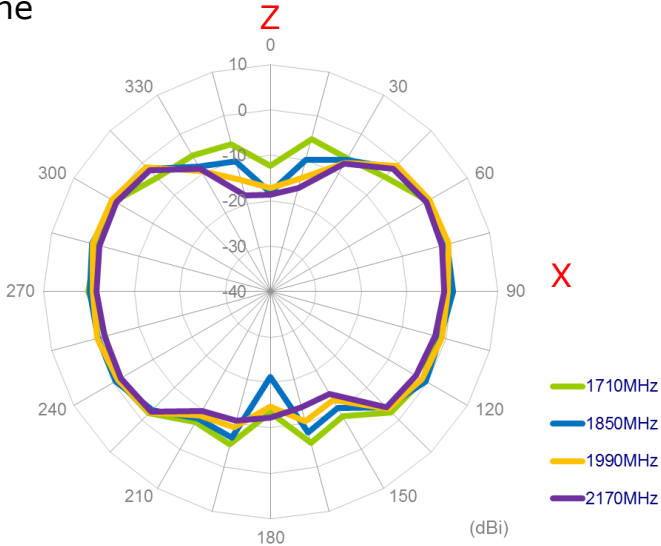
XY Plane



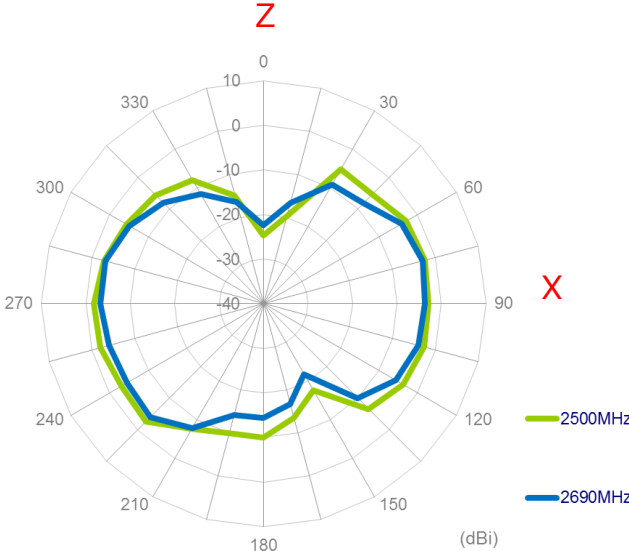
XZ Plane



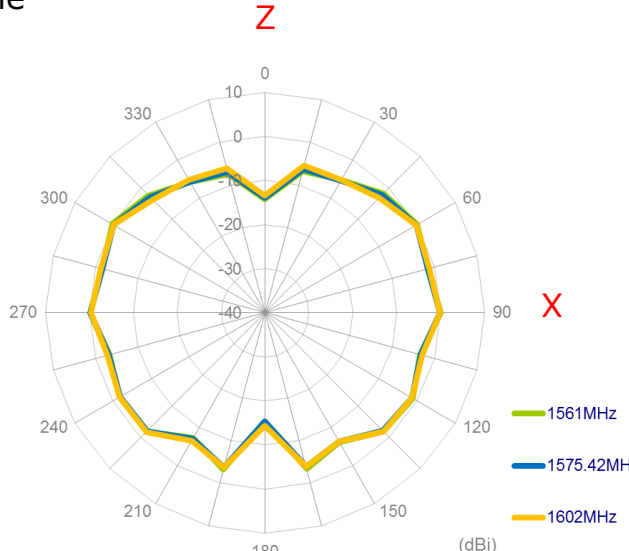
XZ Plane



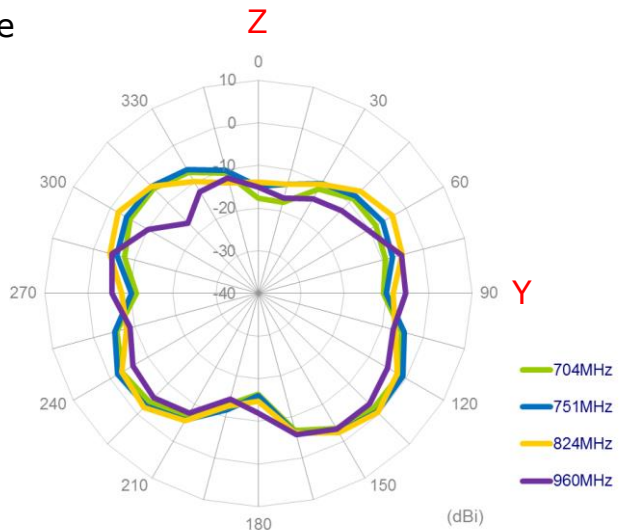
XZ Plane



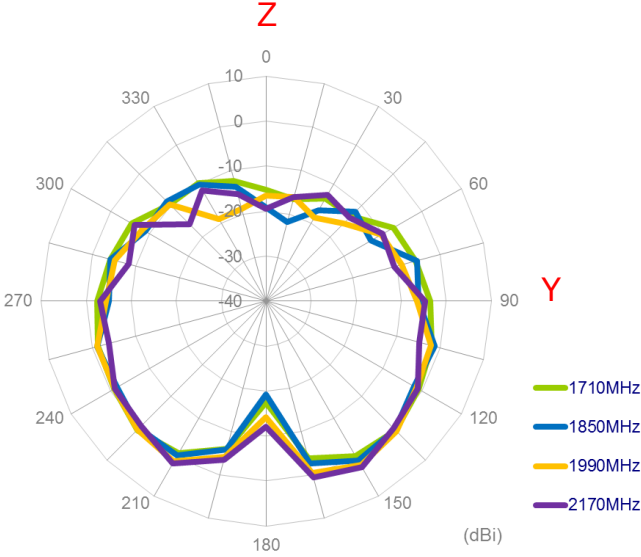
XZ Plane



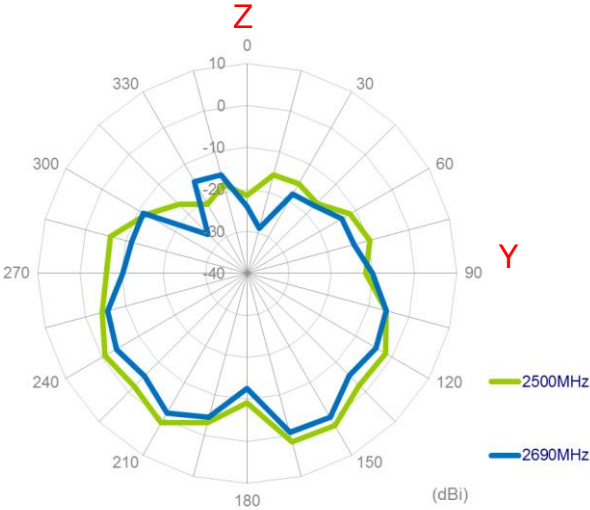
YZ Plane



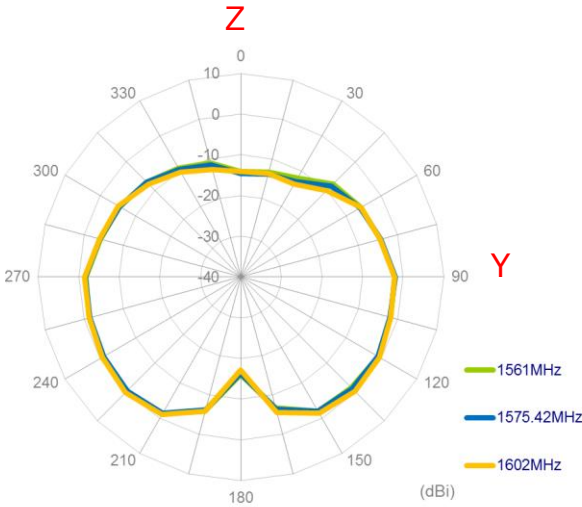
YZ Plane



YZ Plane



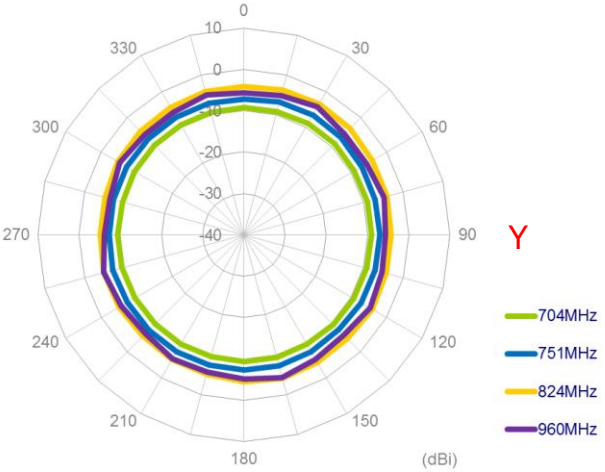
YZ Plane



**2D Radiation Pattern  
(Bent Position with 30\*30cm Metal Ground Center )**

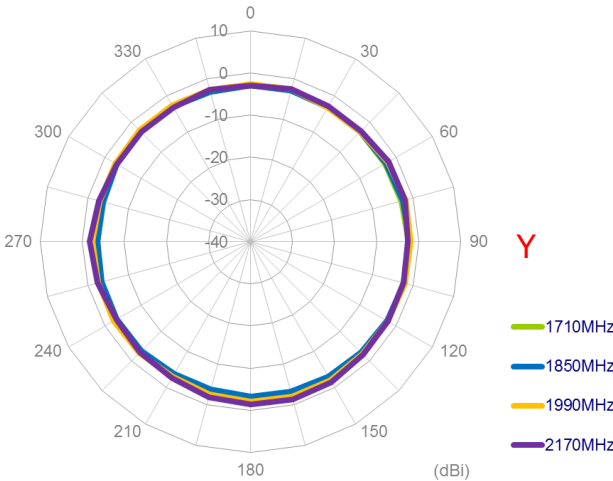
X

XY Plane



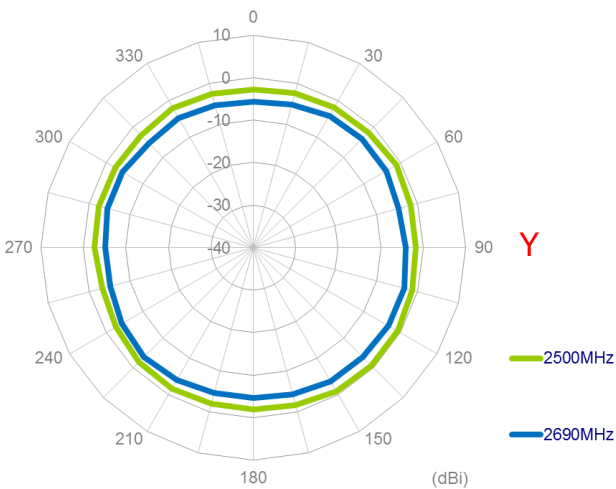
XY Plane

X



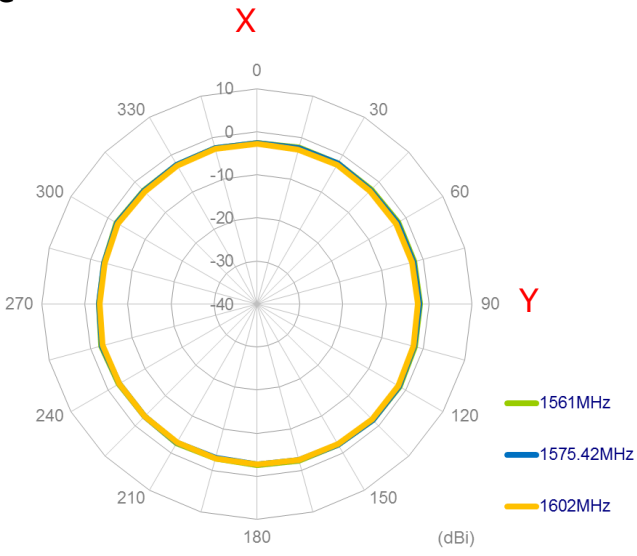
XY Plane

X

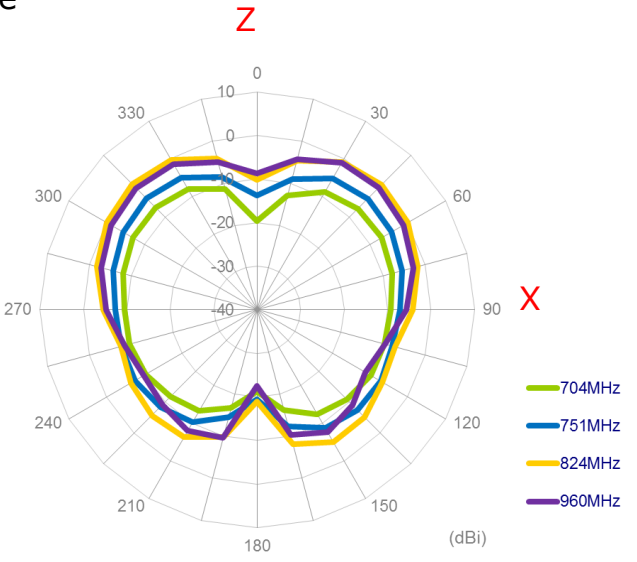




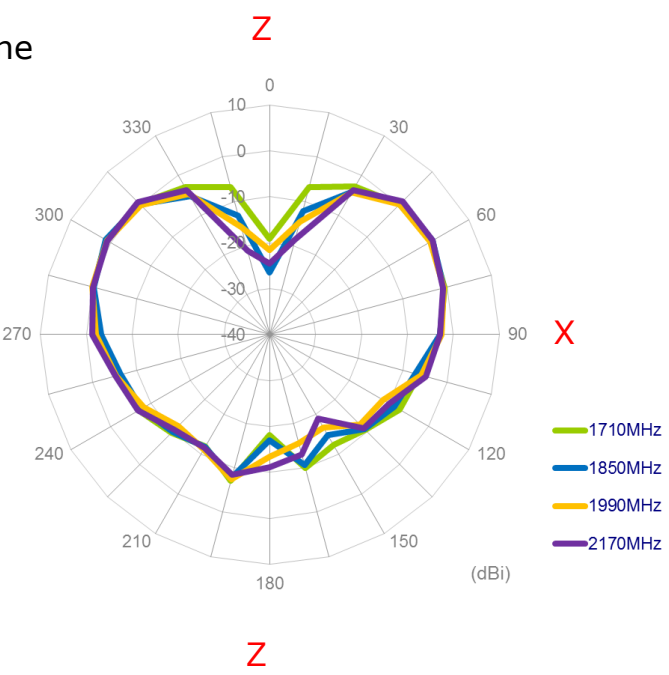
XY Plane



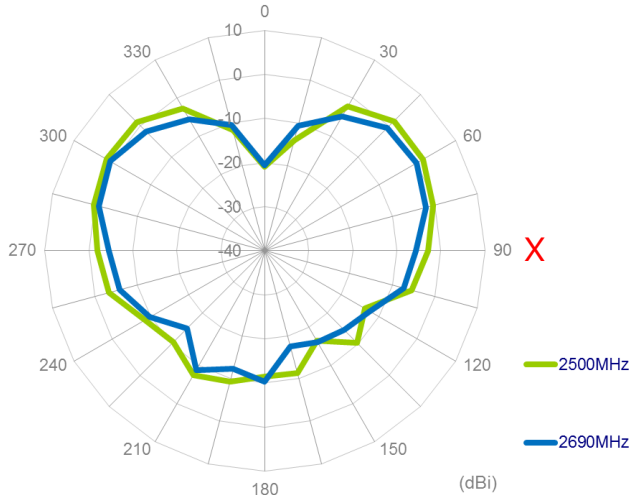
XZ Plane



XZ Plane

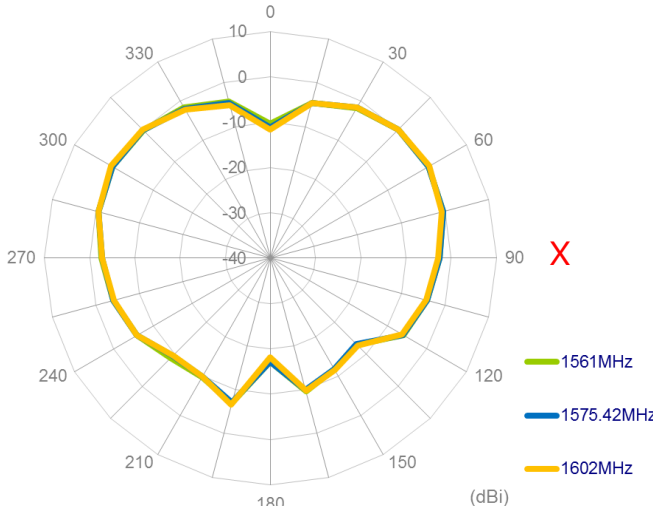


XZ Plane



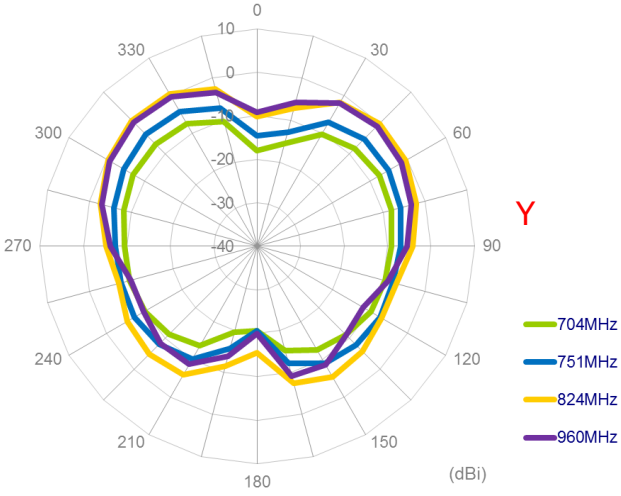
XZ Plane

Z

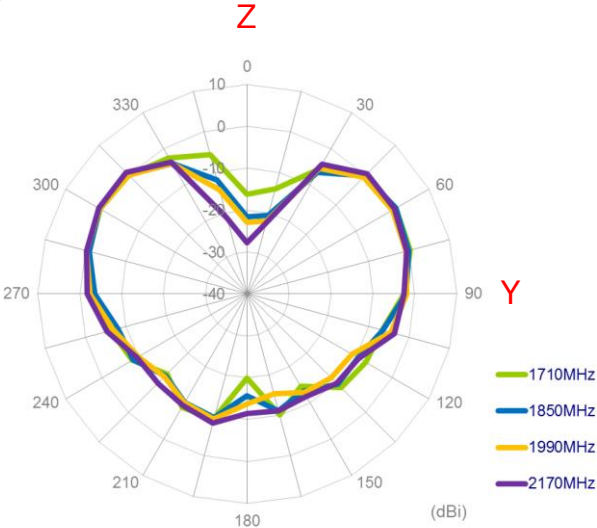


YZ Plane

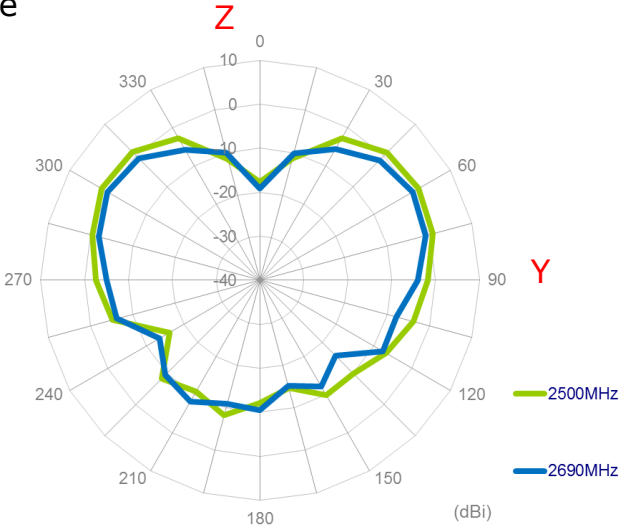
Z



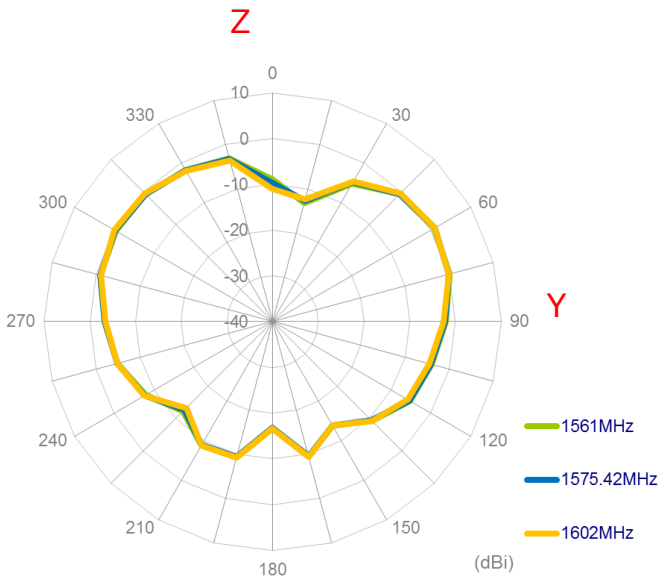
YZ Plane



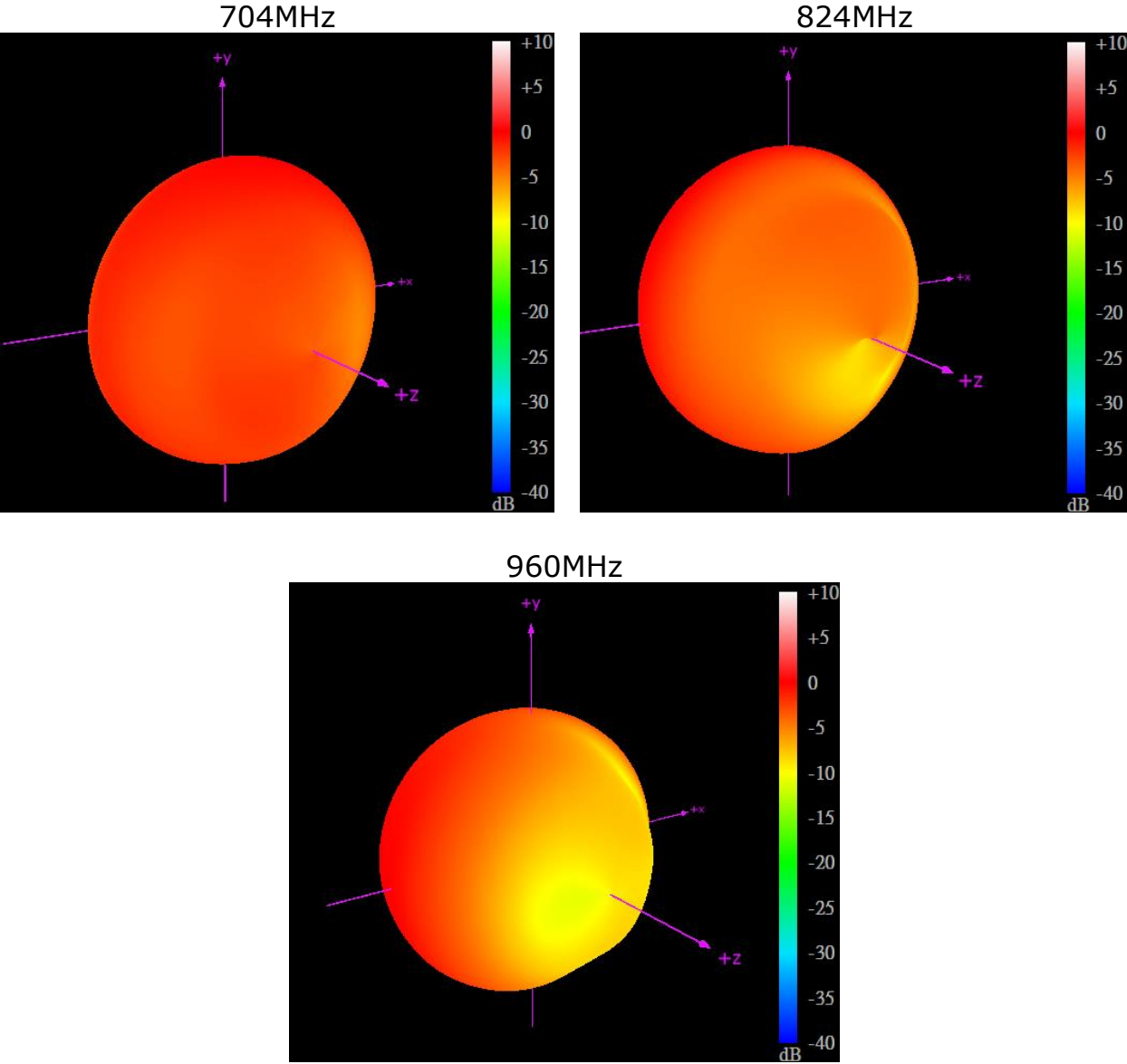
YZ Plane



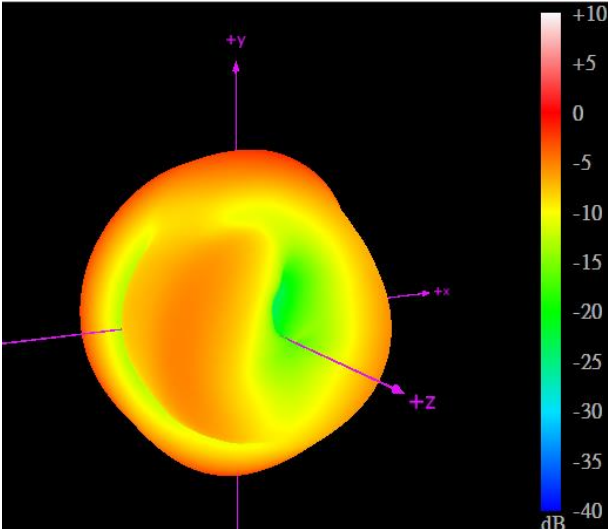
YZ Plane



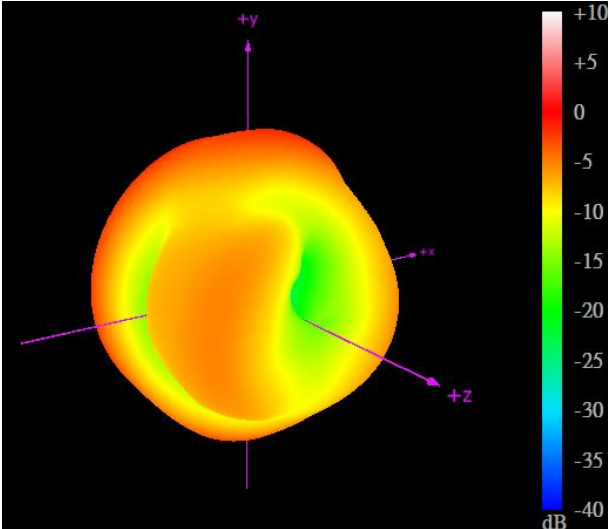
**3D Radiation Pattern  
(Straight Position in Free Space)**



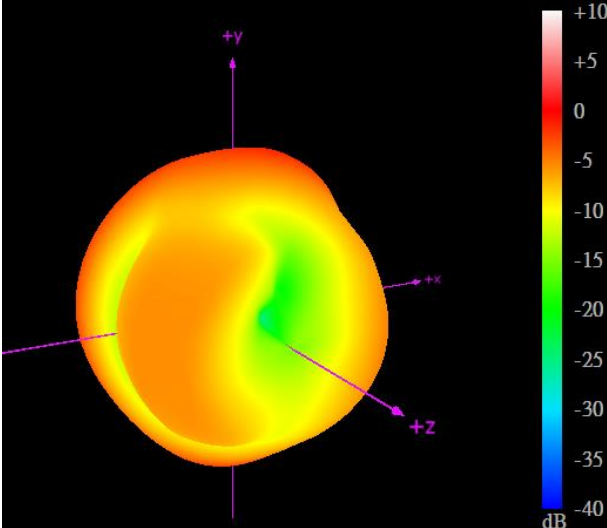
1561MHz



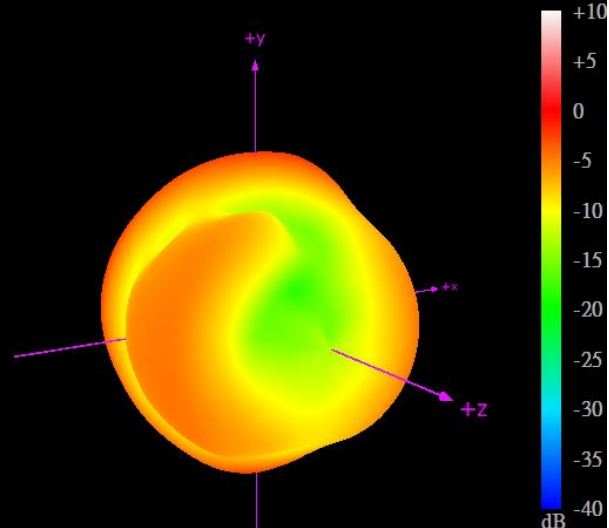
1575.42MHz



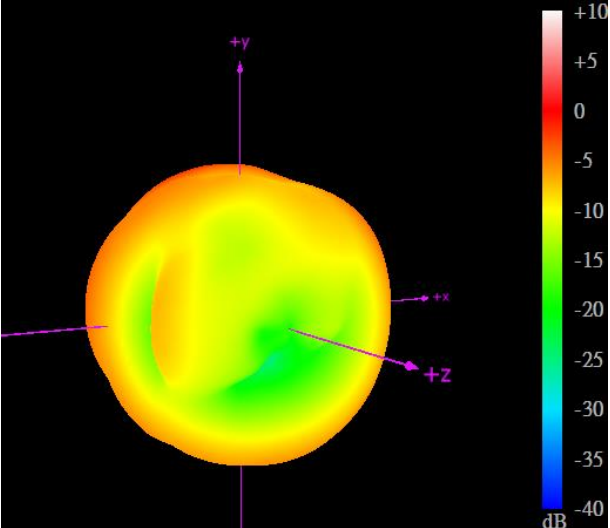
1602MHz



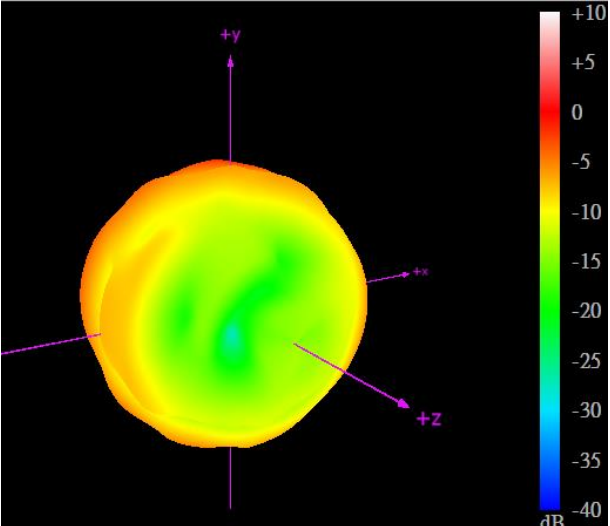
1710MHz



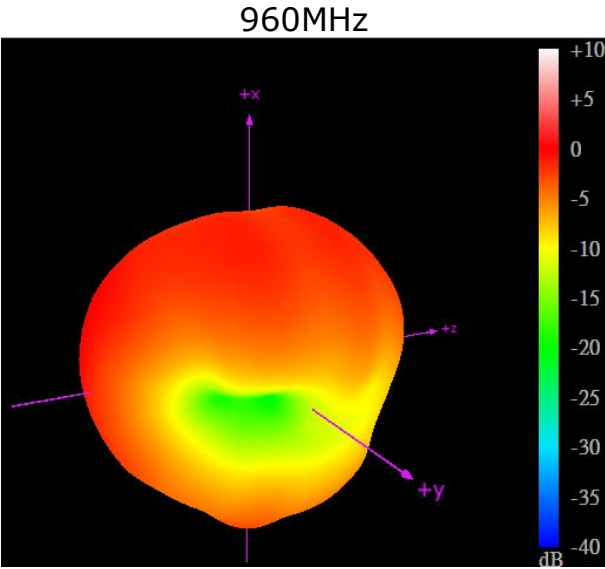
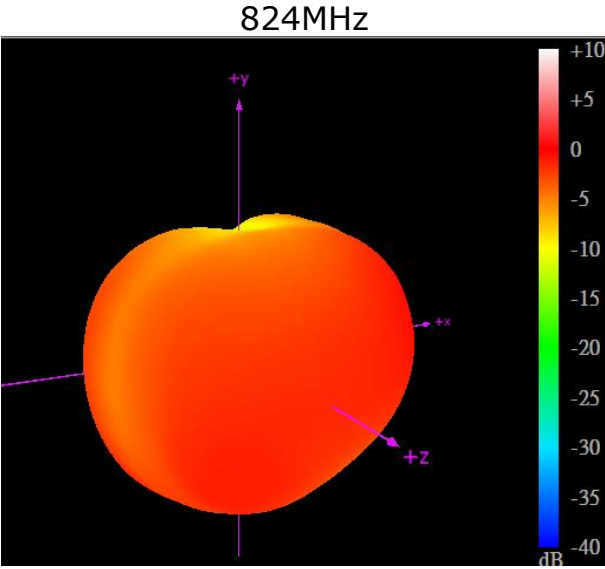
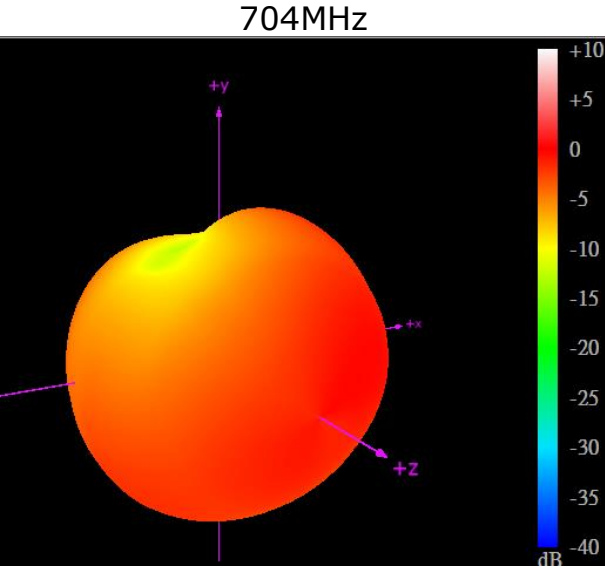
2170MHz



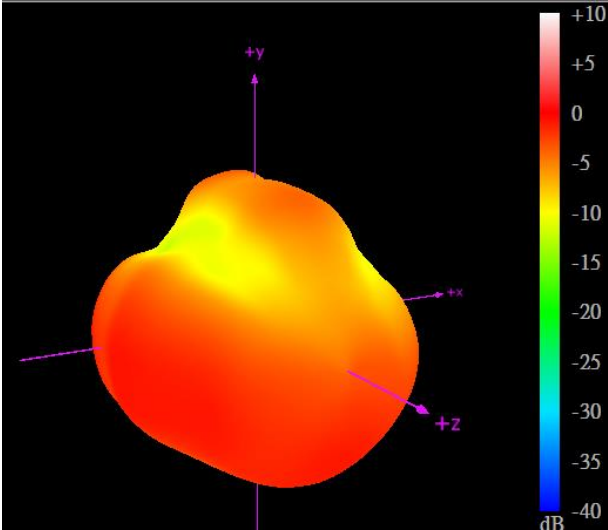
2690MHz



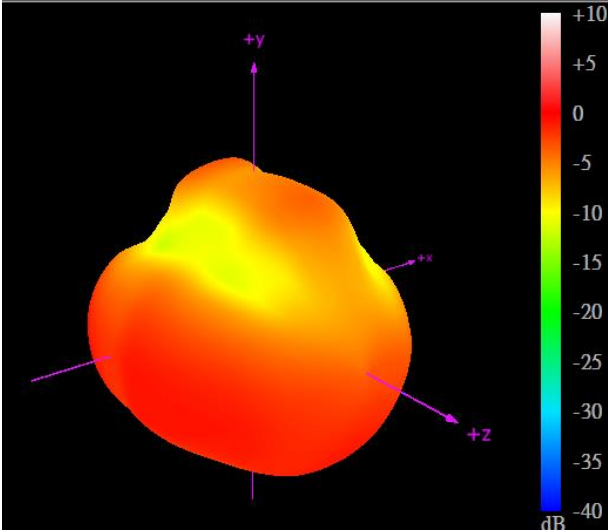
**3D Radiation Pattern  
(Straight Position with 15x9cm Ground)**



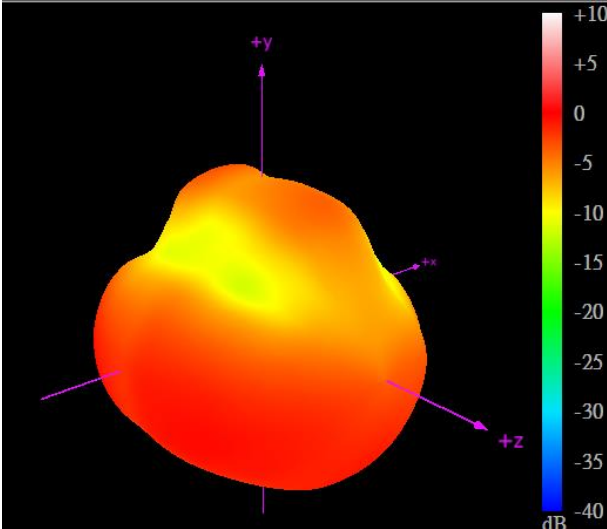
1561MHz



1575.42MHz

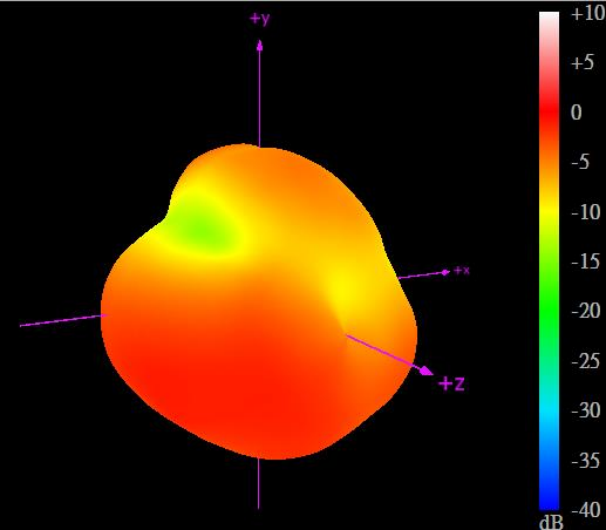


1602MHz

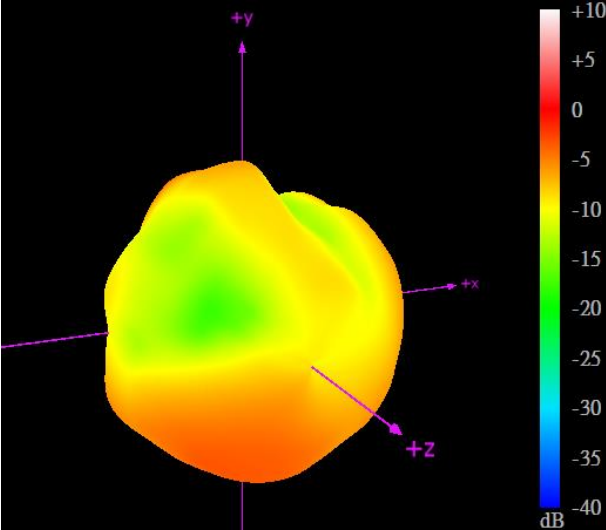




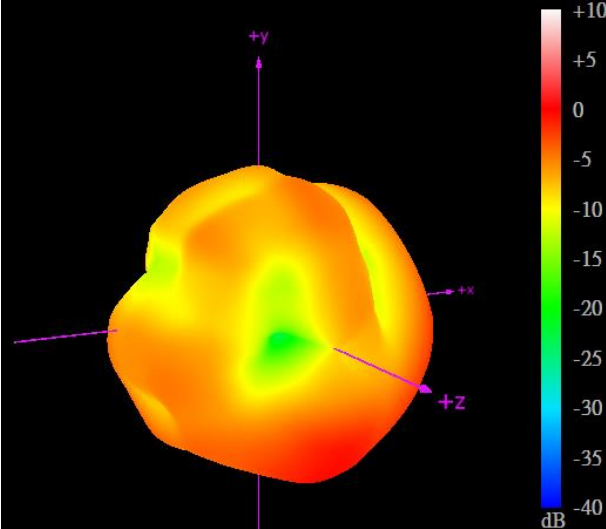
1710MHz



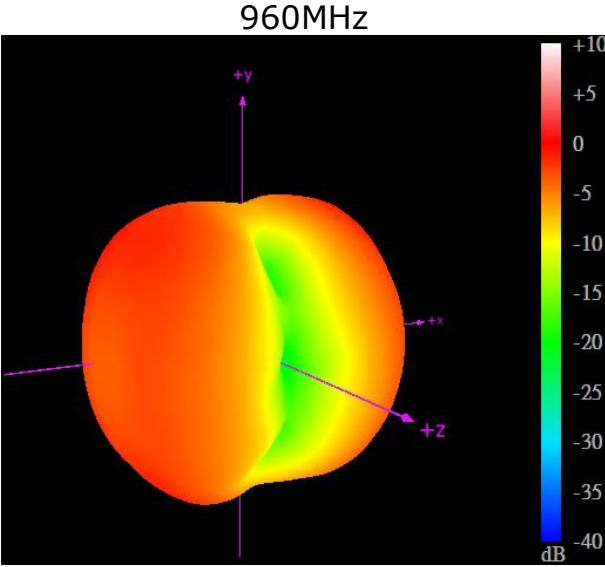
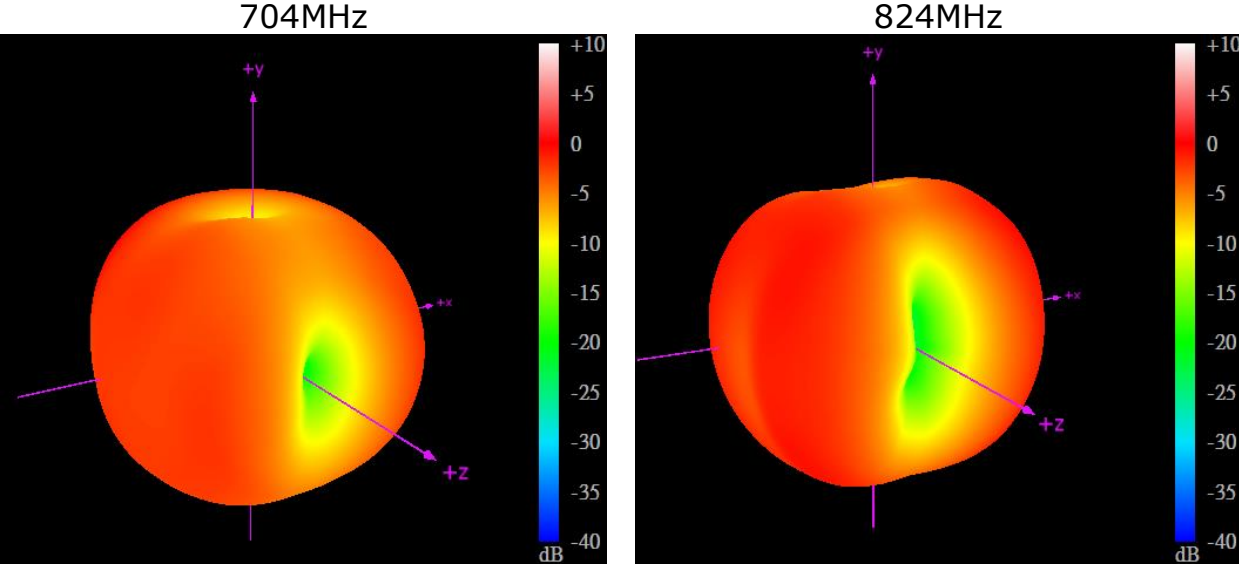
2170MHz



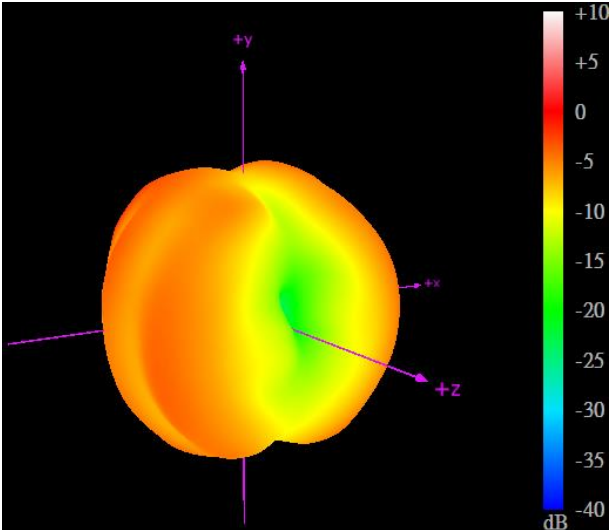
2690MHz



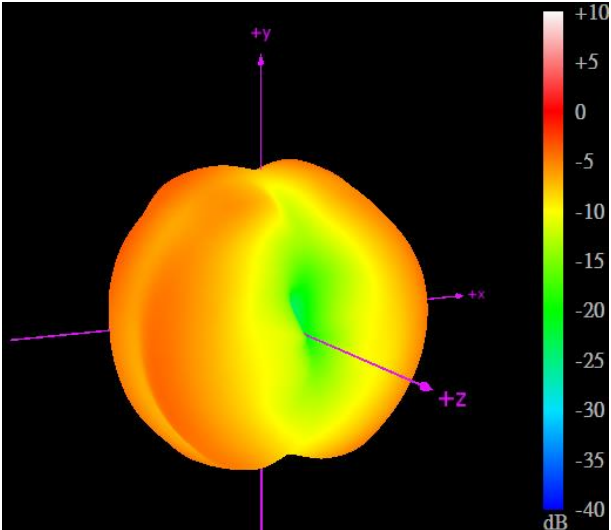
**3D Radiation Pattern  
(Straight Position with 30x30cm Metal Ground Edge)**



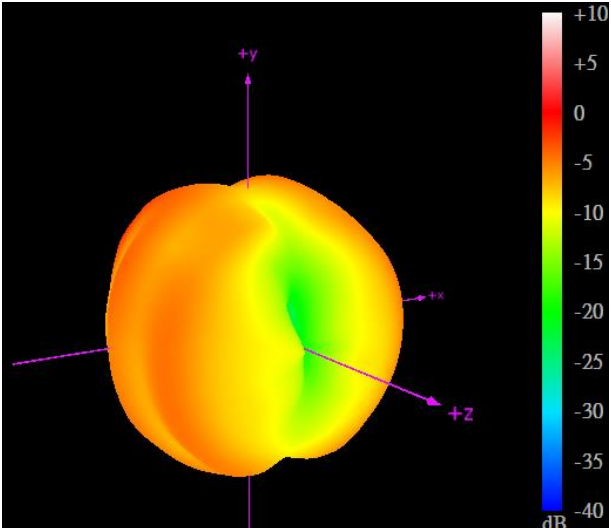
1561MHz



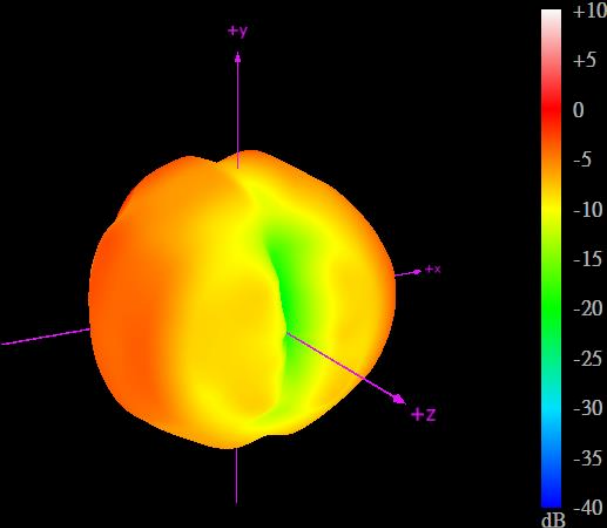
1575.42MHz



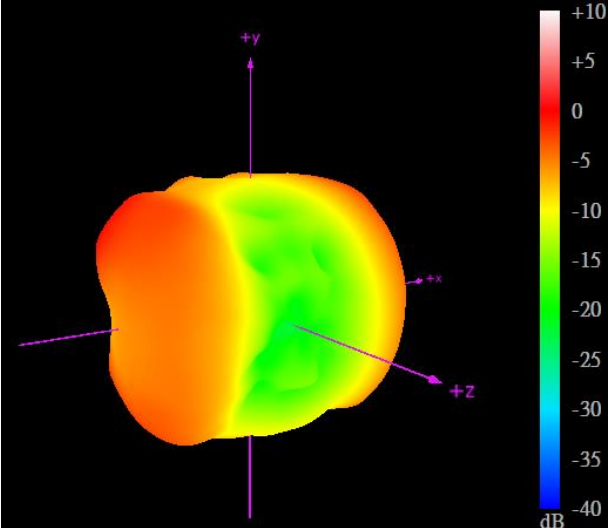
1602MHz



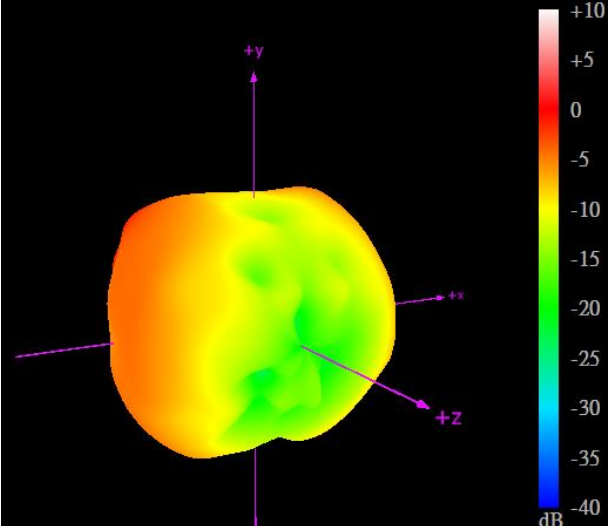
1710MHz



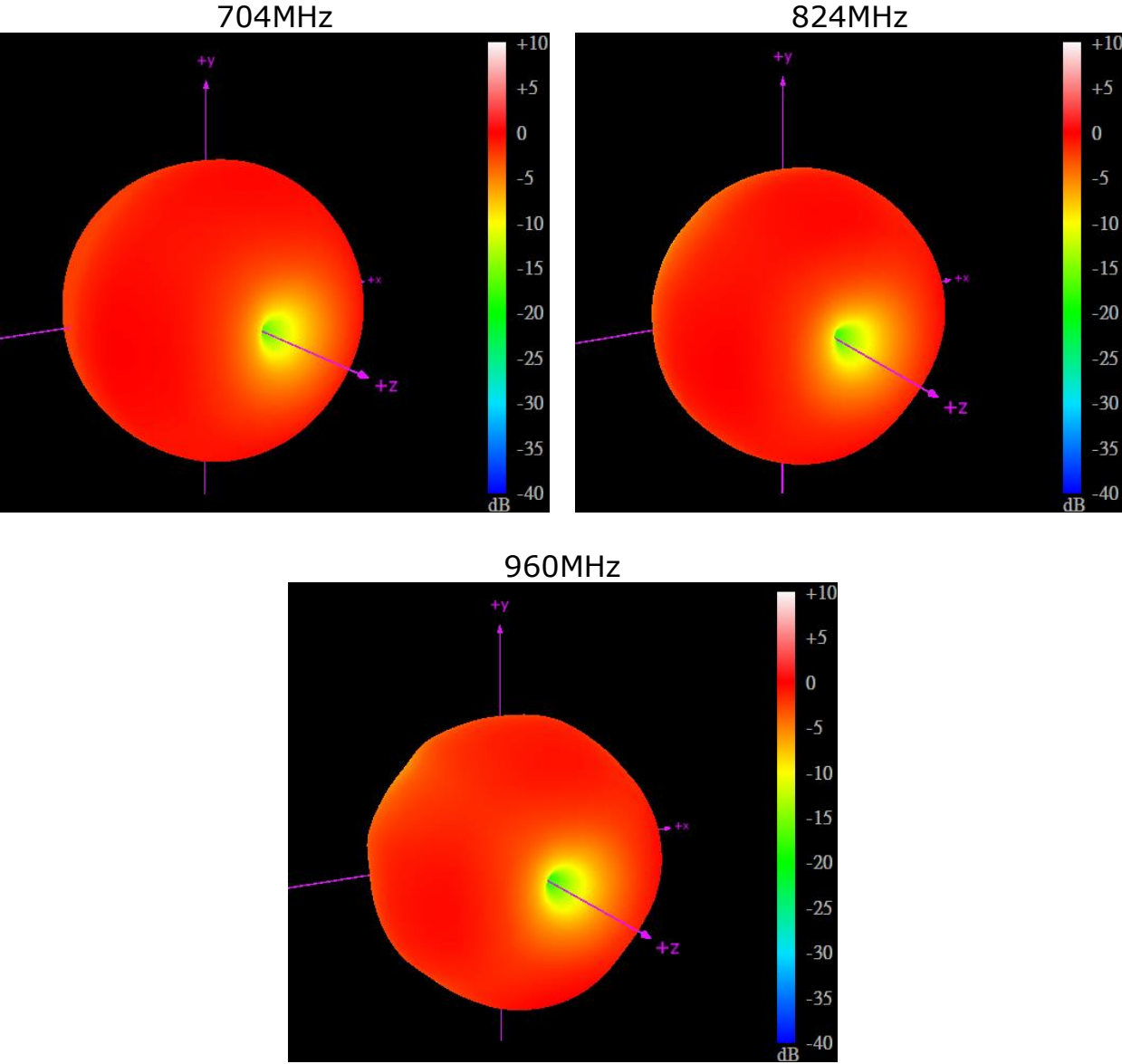
2170MHz



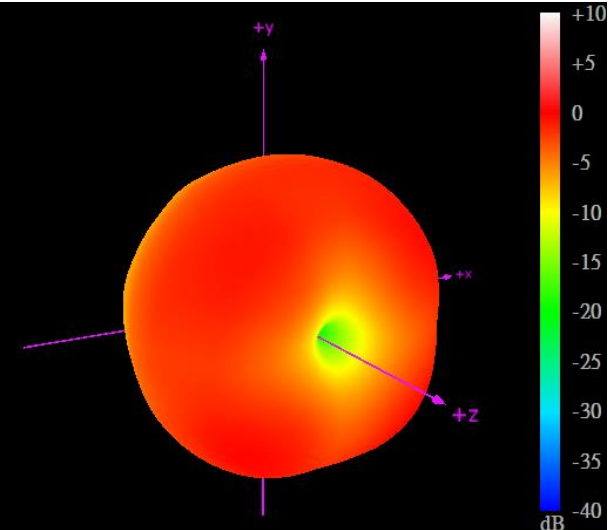
2690MHz



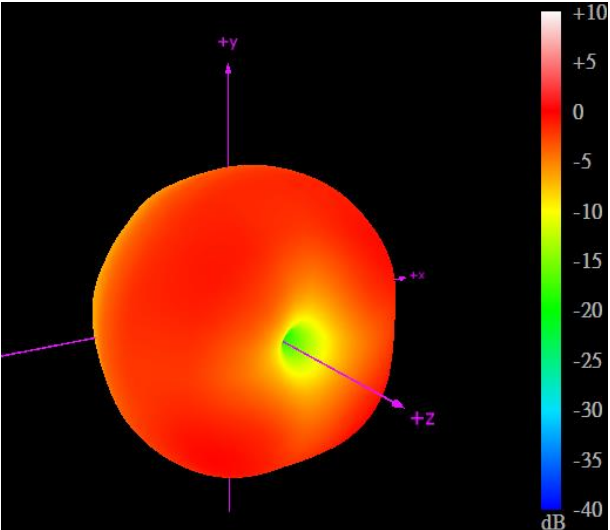
**3D Radiation Pattern  
(Straight Position with 30x30cm Metal Ground Center)**



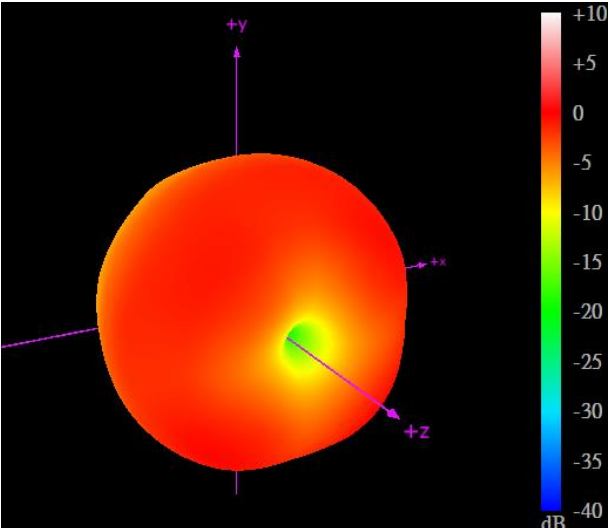
1561MHz



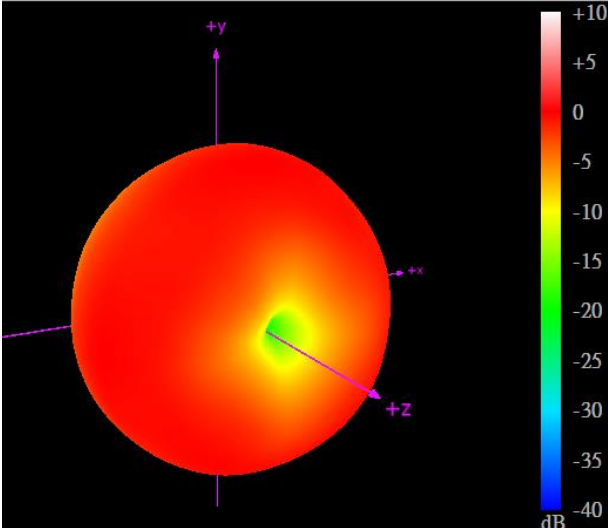
1575.42MHz



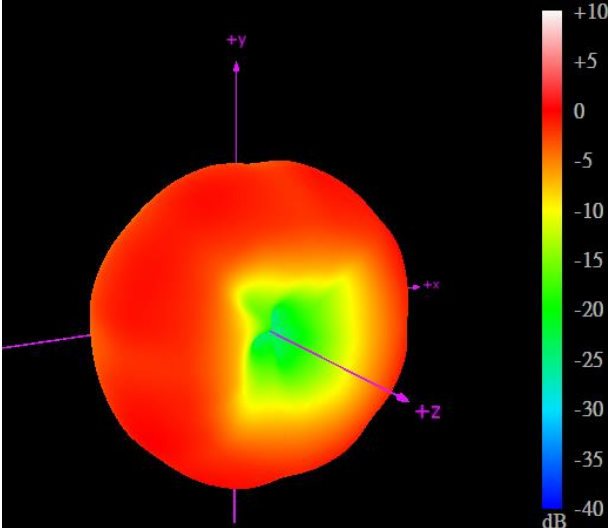
1602MHz



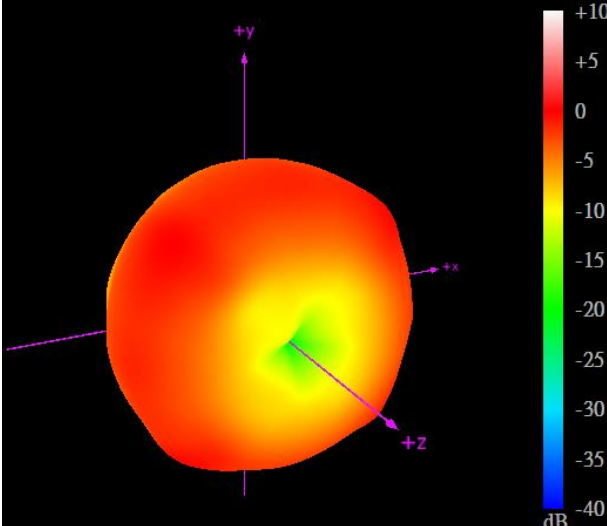
1710MHz



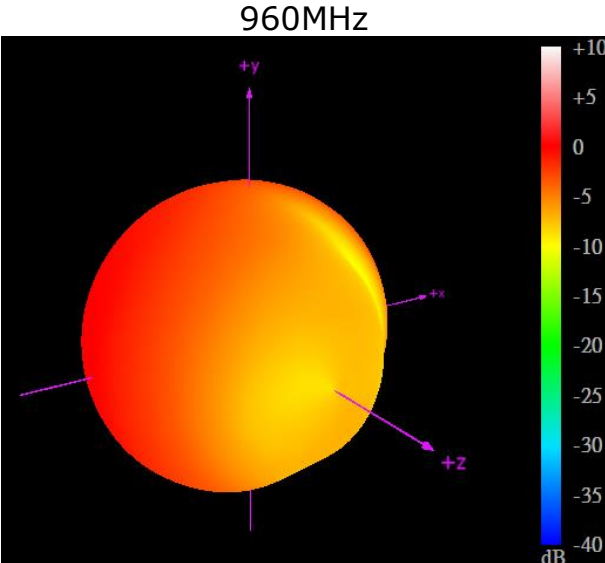
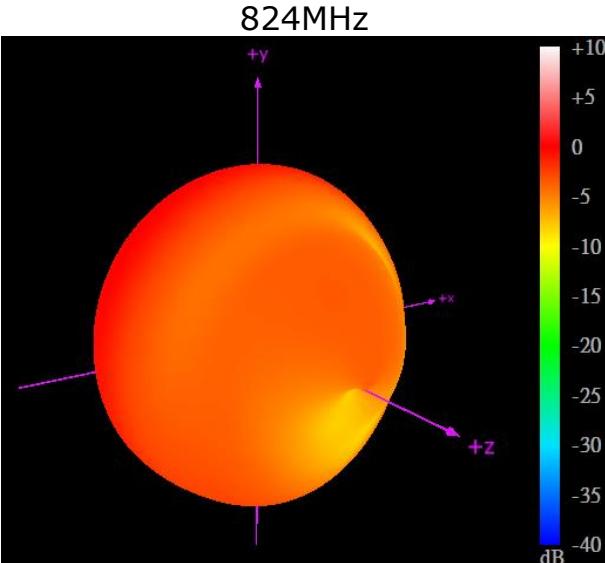
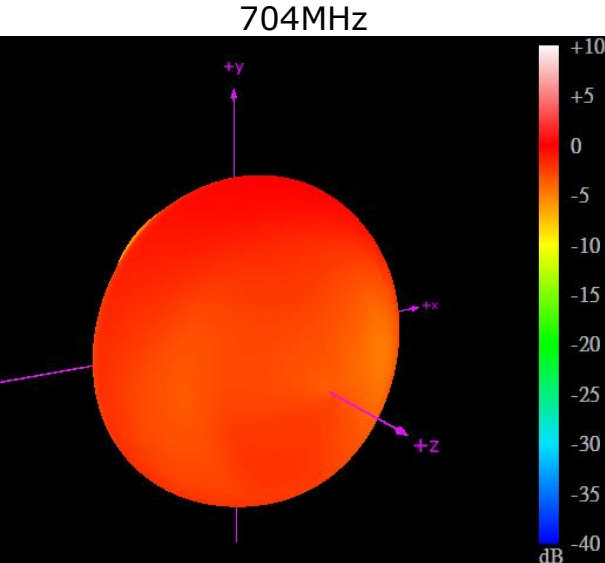
2170MHz



2690MHz

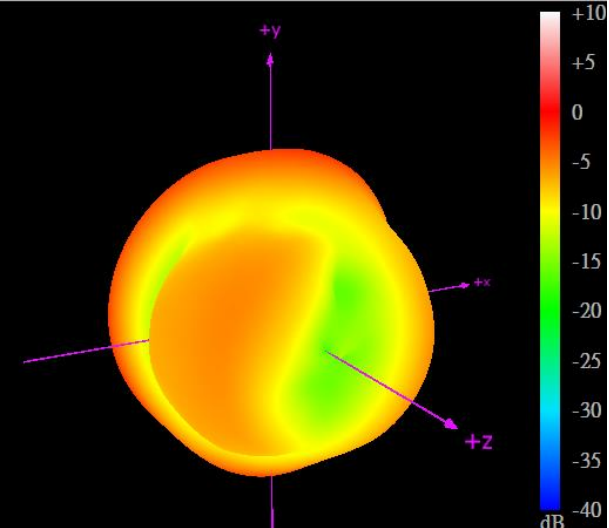


**3D Radiation Pattern  
(Bent Position with in Free Space)**

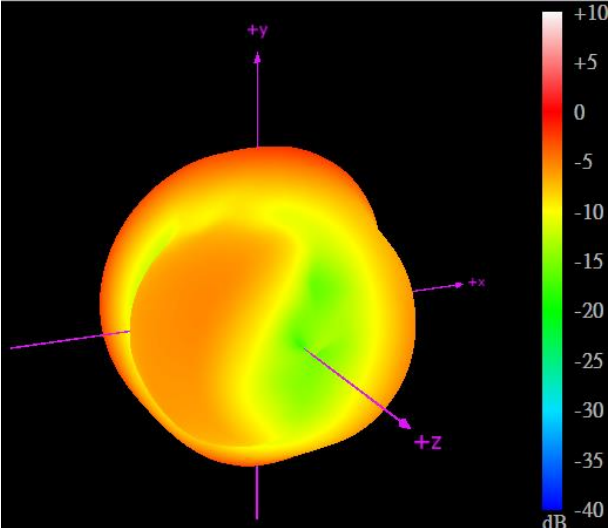




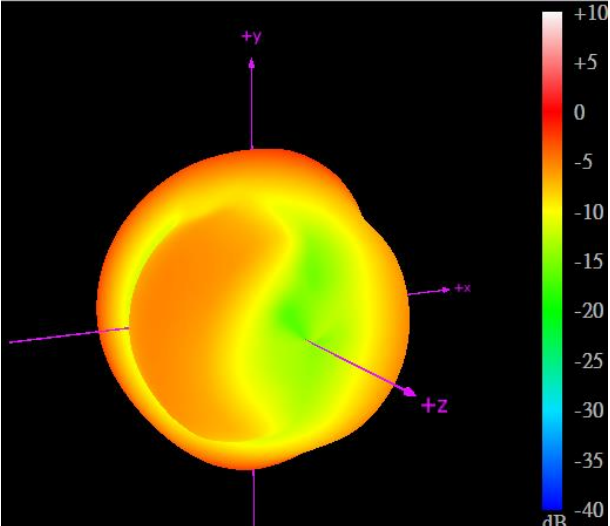
1561MHz



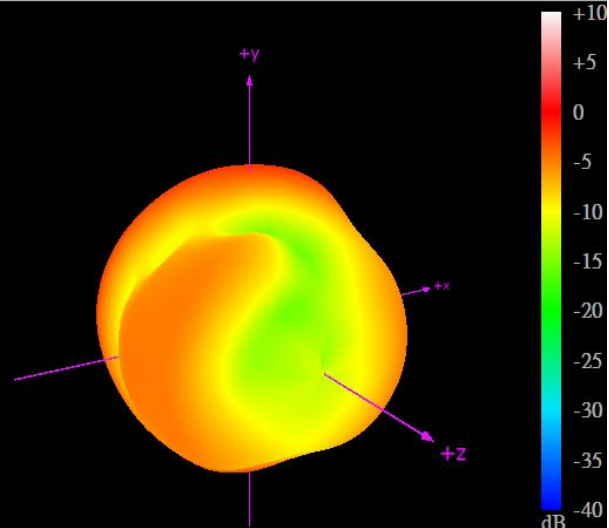
1575.42MHz



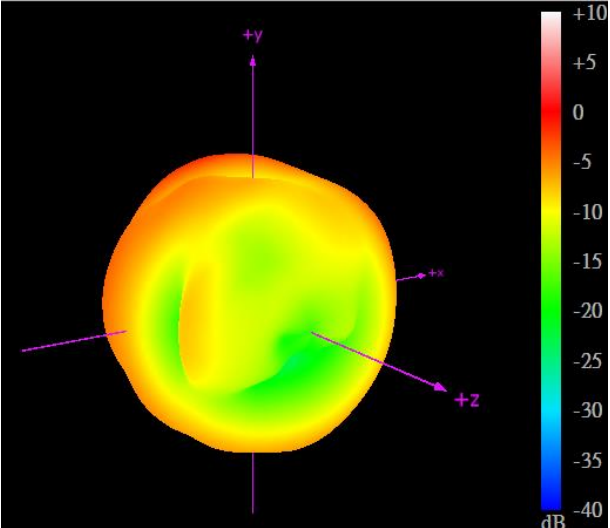
1602MHz



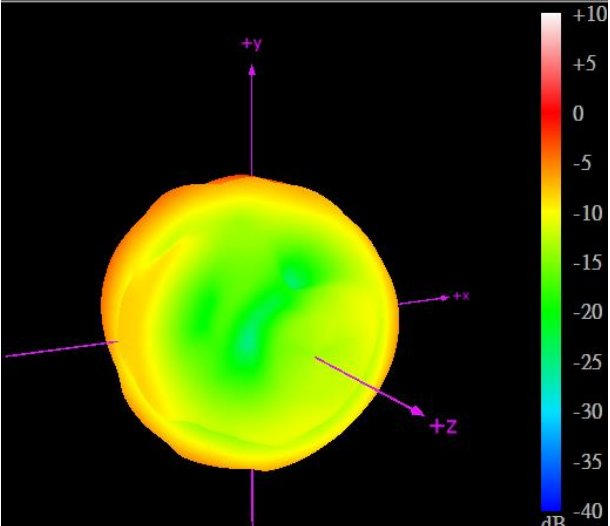
1710MHz



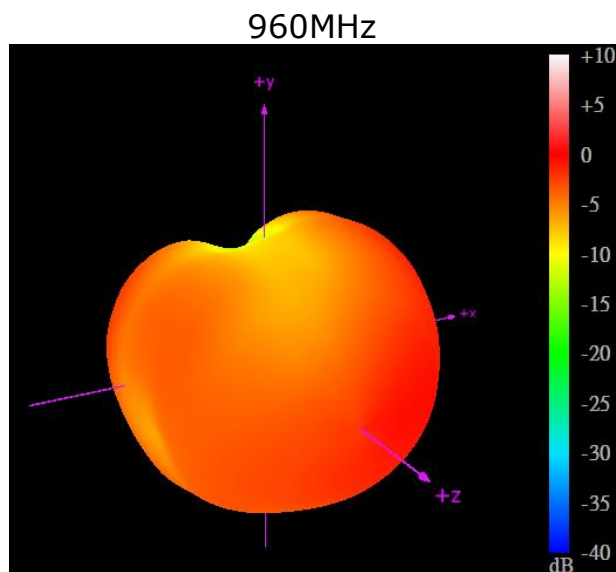
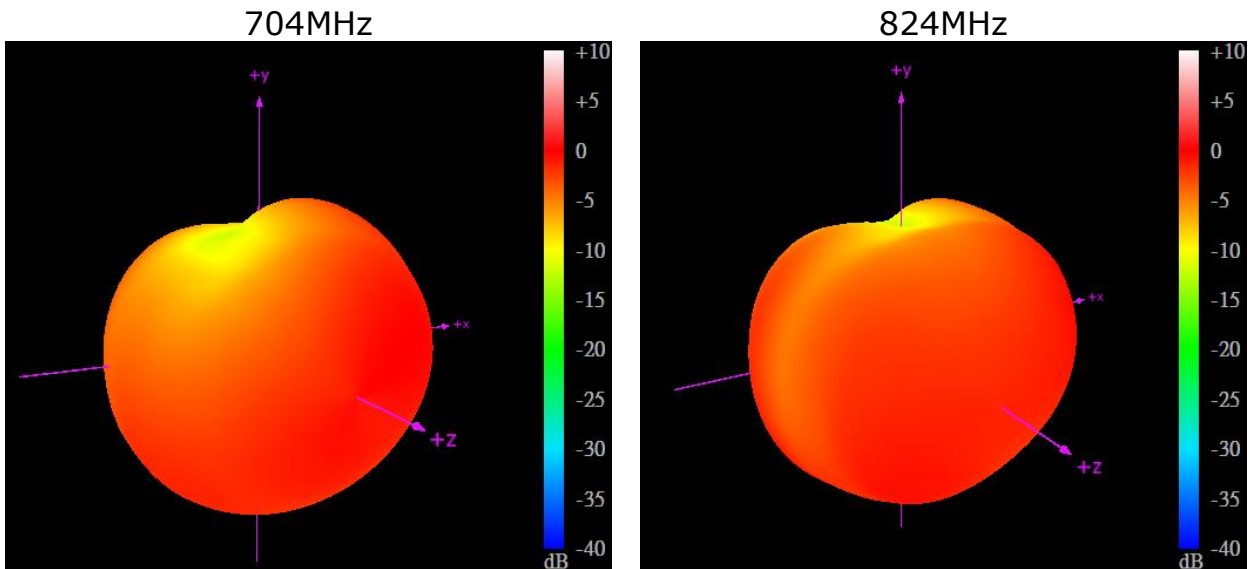
2170MHz



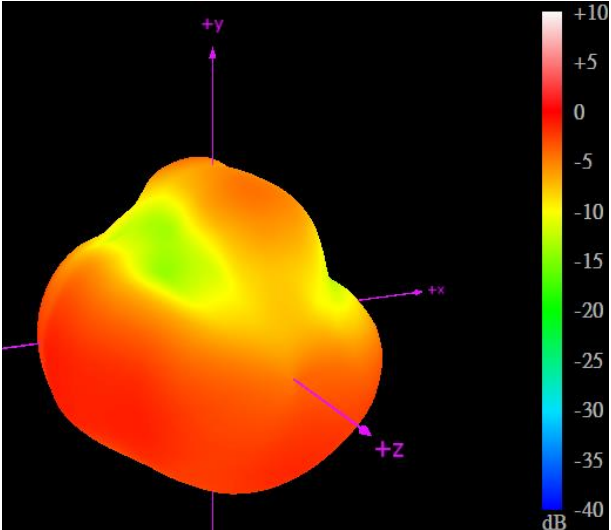
2690MHz



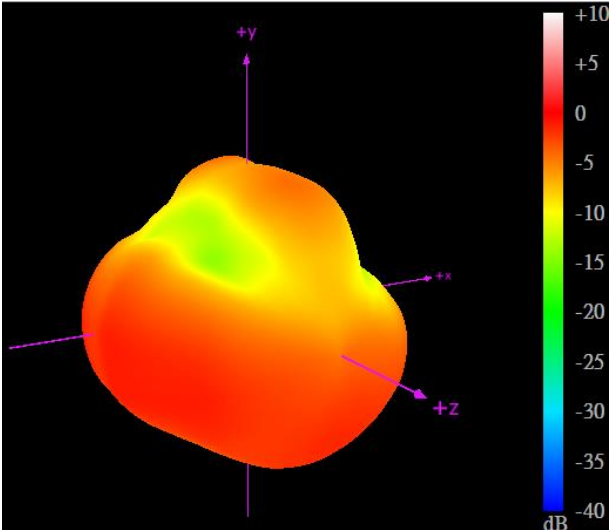
**3D Radiation Pattern  
(Bent Position with 15x9cm Ground)**



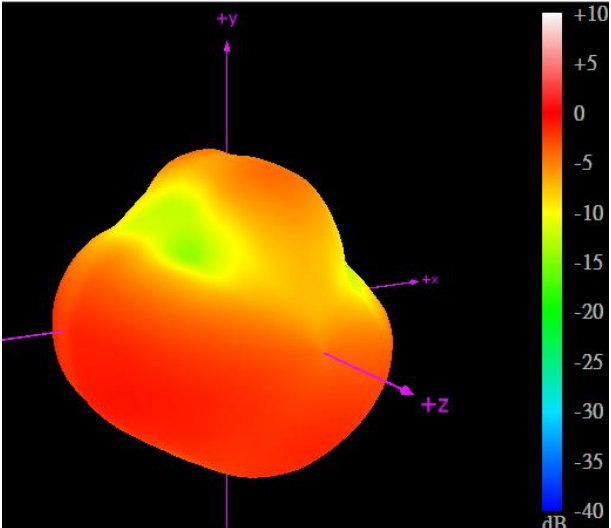
1561MHz



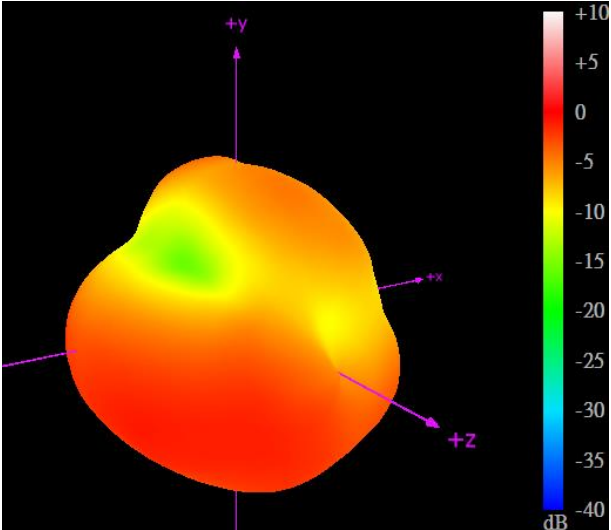
1575.42MHz



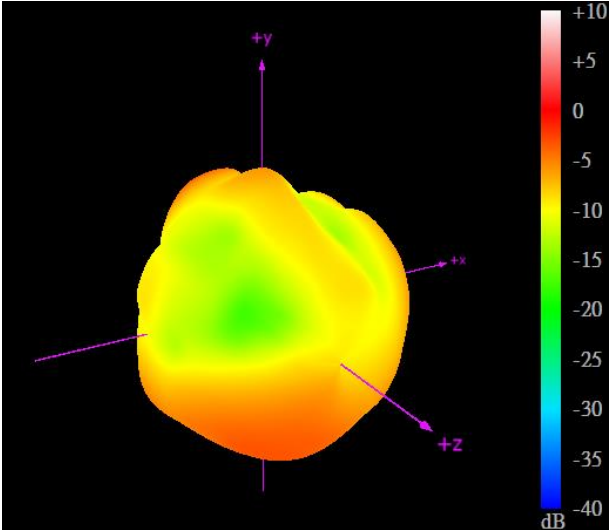
1602MHz



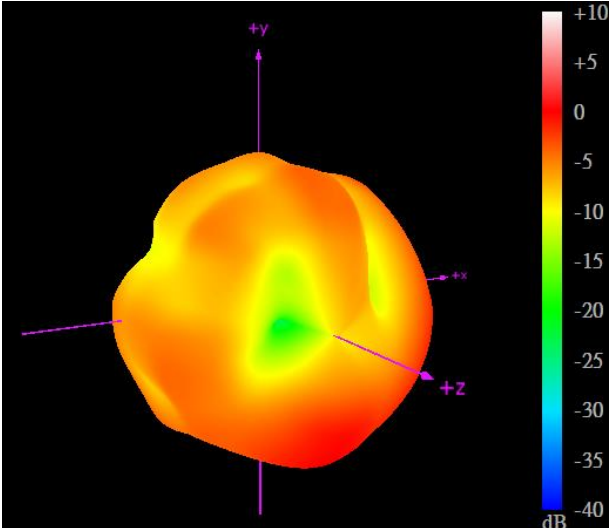
1710MHz



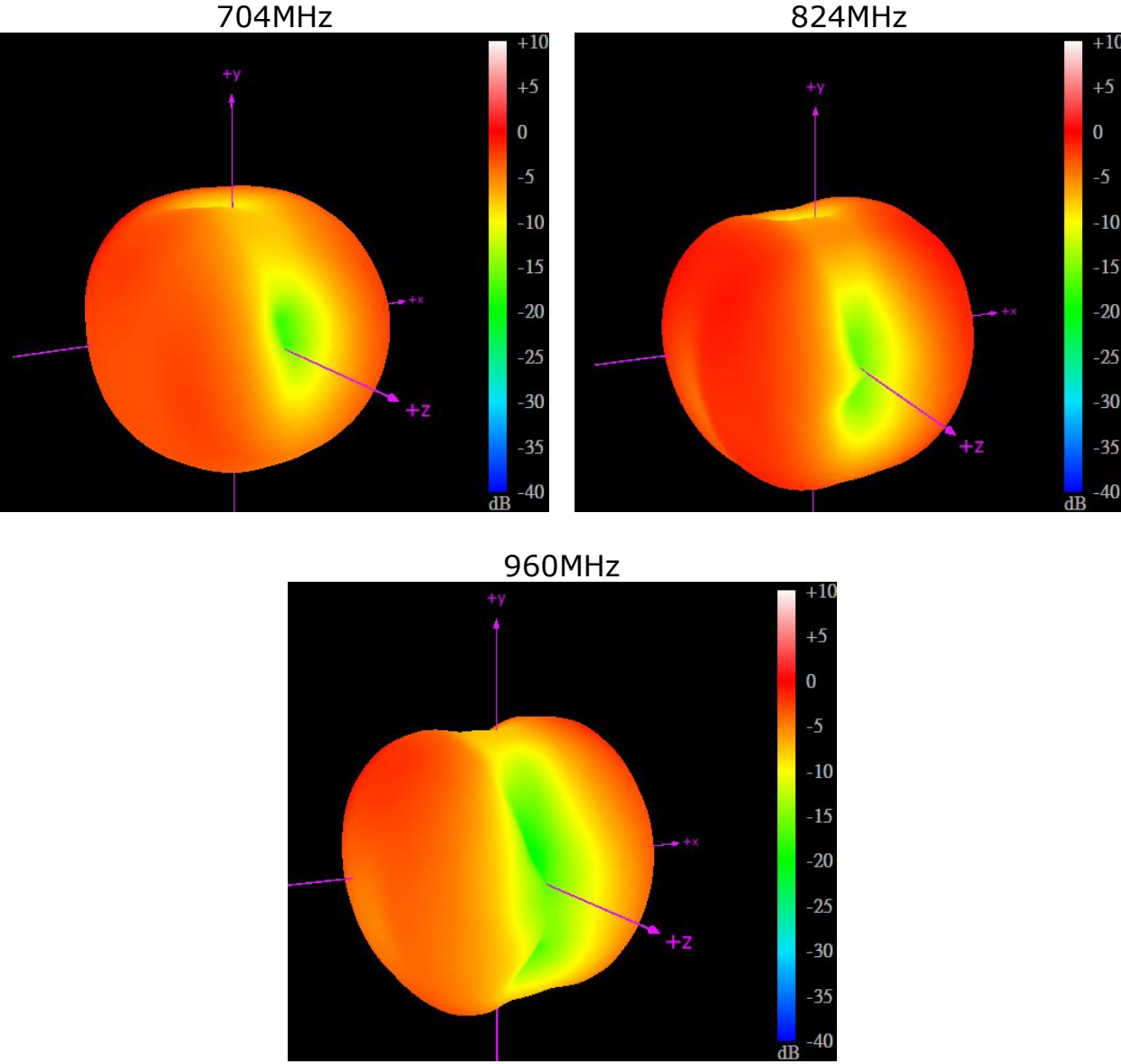
2170MHz



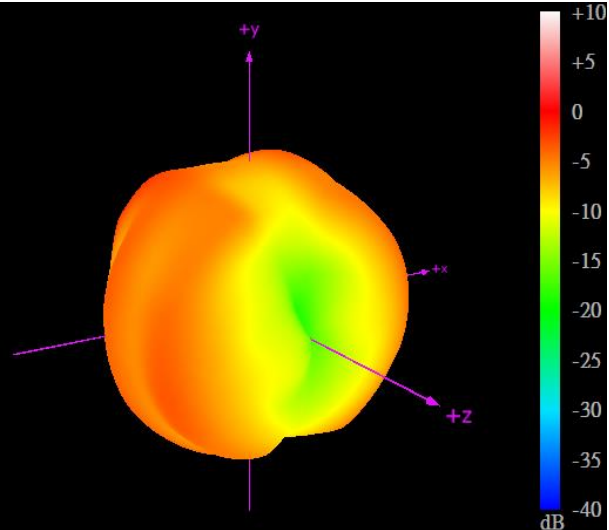
2690MHz



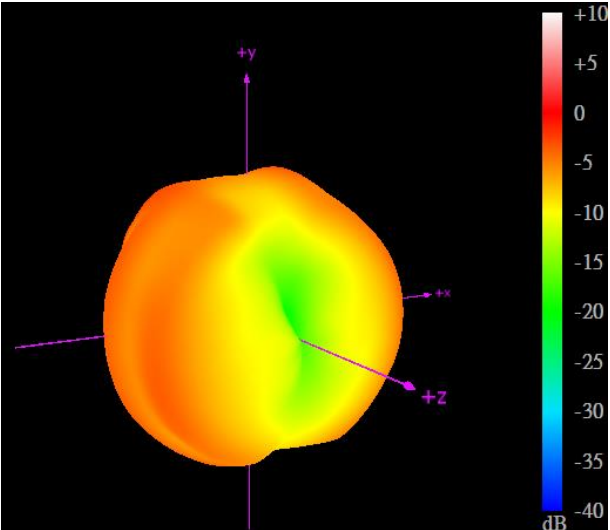
**3D Radiation Pattern  
(Bent Position with 30x30cm Metal Ground Edge)**



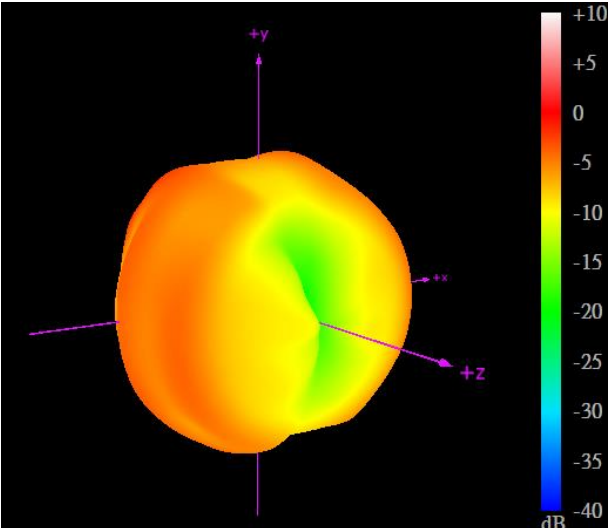
1561MHz



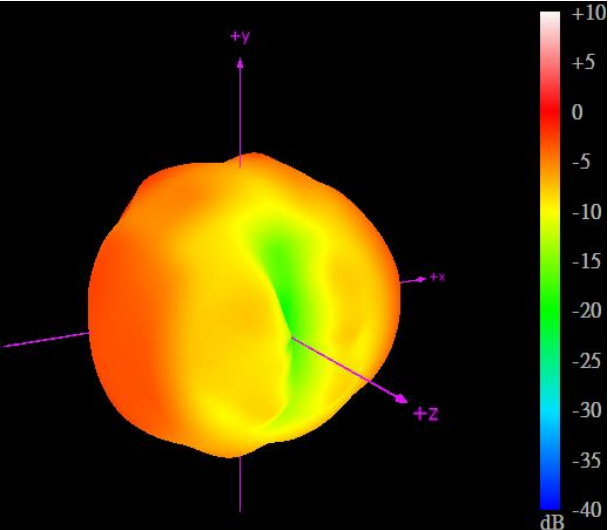
1575.42MHz



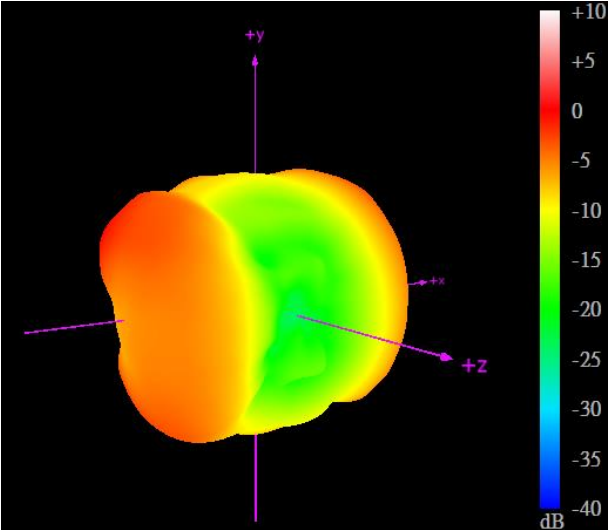
1602MHz



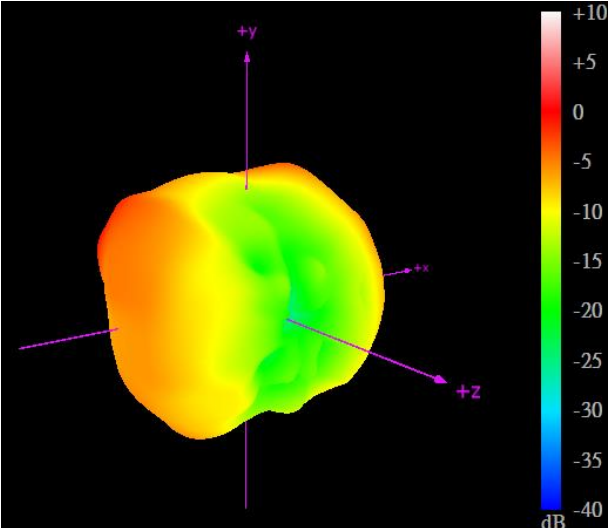
1710MHz



2170MHz

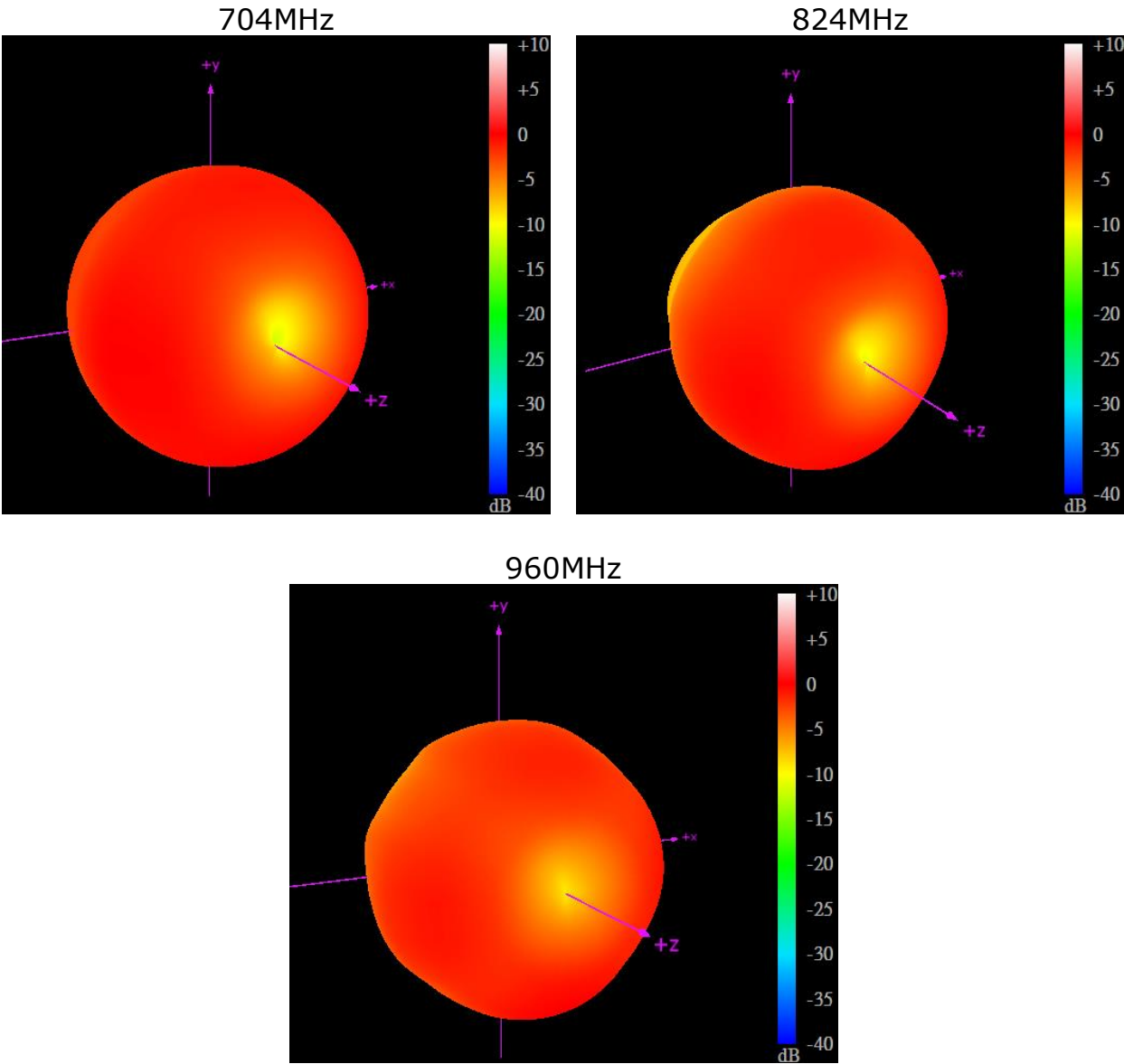


2690MHz

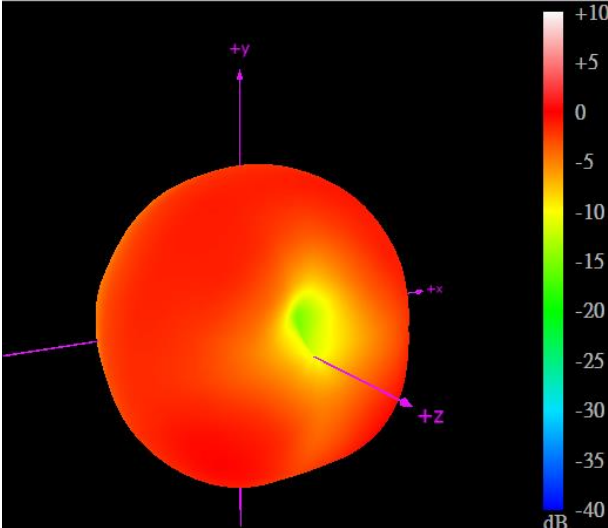




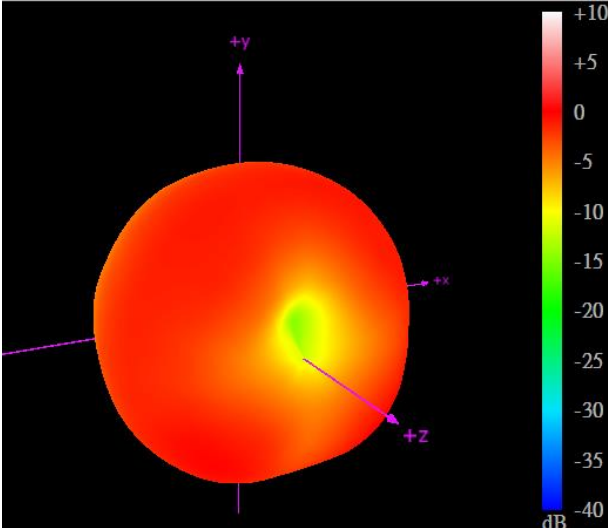
**3D Radiation Pattern  
(Bent Position with 30x30cm Metal Ground Center)**



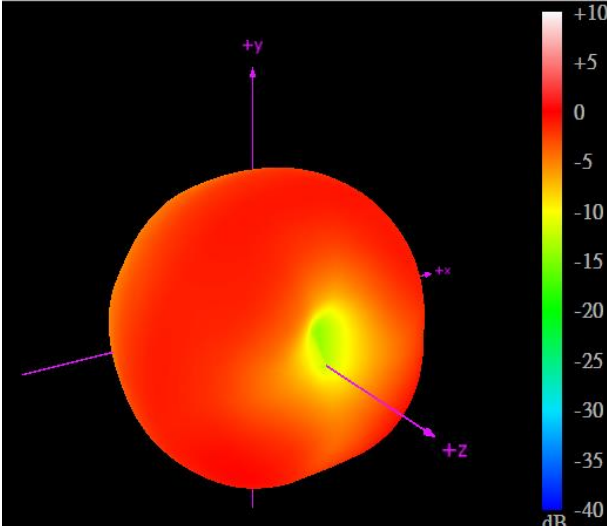
1561MHz



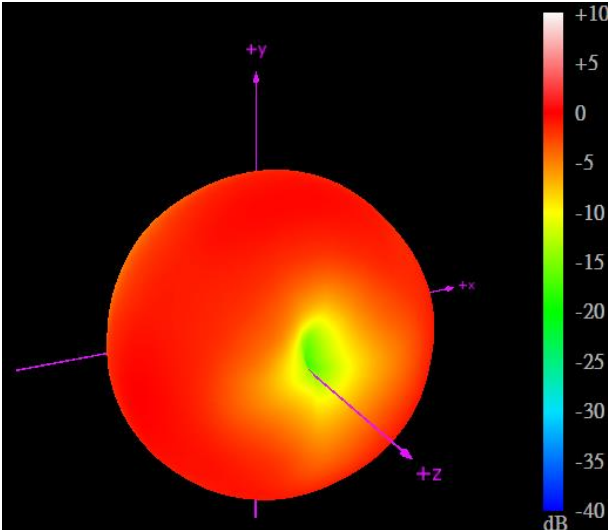
1575.42MHz



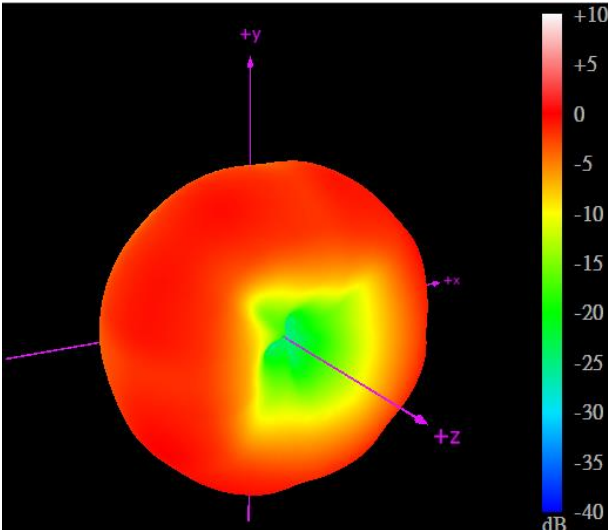
1602MHz



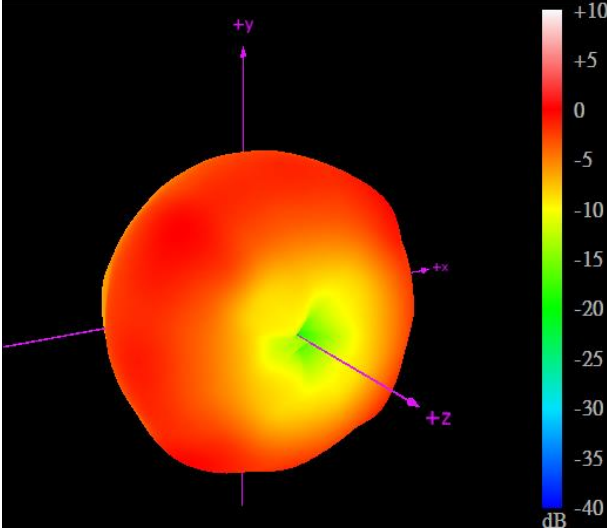
1710MHz



2170MHz

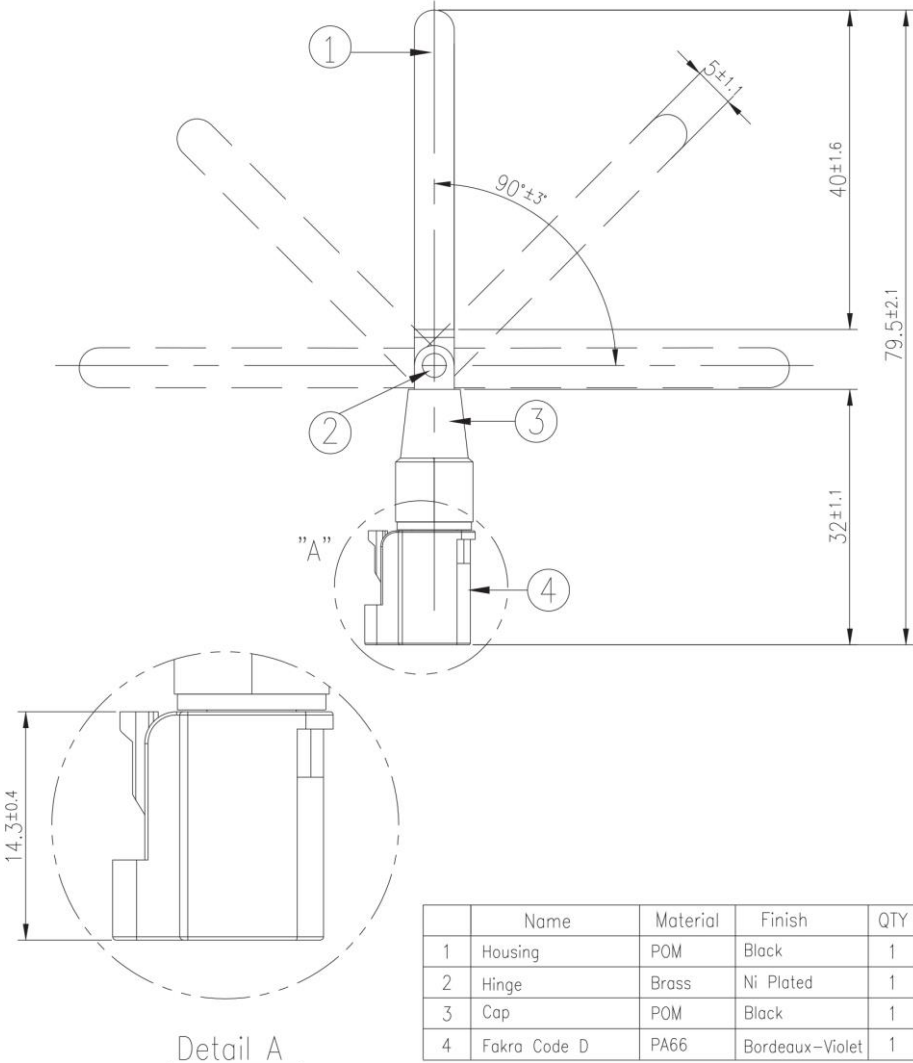


2690MHz



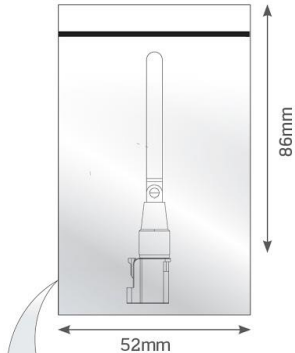
### 3. Mechanical Drawing

(Unit:mm)

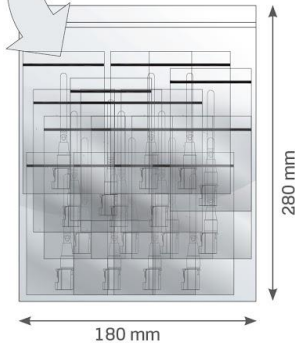


# 4. Packaging

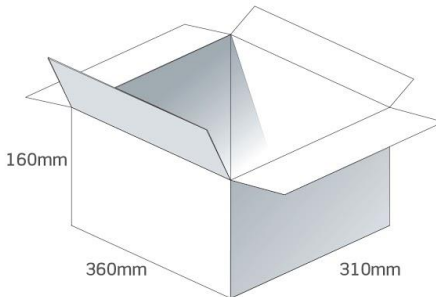
1 pcs TG.08.0723 per PE bag  
 PE Bag Dimensions - 52 x 86mm  
 Weight - 8.5g



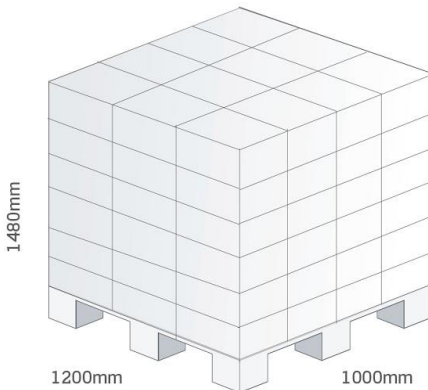
100 PE bags per large PE bags  
 100 pcs TG.08.0723 per large PE bags  
 Large PE bags Dimensions - 280 x 180mm  
 Weight - 0.9Kg



10 Large PE bags per carton  
 1000 pcs TG.08.0723 per carton  
 Carton Dimensions - 360 x 310 x 160mm  
 Weight - 9.5Kg



Pallet Dimensions 1200\*1000\*1480mm  
 72 Cartons per Pallet  
 9 Cartons per layer  
 8 Layers



Taoglas makes no warranties based on the accuracy or completeness of the contents of this document and reserves the right to make changes to specifications and product descriptions at any time without notice. Taoglas reserves all rights to this document and the information contained herein.

Reproduction, use or disclosure to third parties without express permission is strictly prohibited.

Copyright © Taoglas Ltd.

## X-ON Electronics

Largest Supplier of Electrical and Electronic Components

*Click to view similar products for [Antennas](#) category:*

*Click to view products by [Taoglas](#) manufacturer:*

Other Similar products are found below :

[GAN30084EU](#) [930-033-R](#) [GW17.07.0250E](#) [1513563-1](#) [EXE902SM](#) [APAMPG-117](#) [MAF94383](#) [W3908B0100](#) [W6102B0100](#) [YE572113-30RSMM](#) [108-00014-50](#) [66089-2406](#) [SPDA17RP918](#) [A09-F8NF-M](#) [A09-F5NF-M](#) [RGFRA1903041A1T](#) [W3593B0100](#) [W3921B0100](#) [SIMNA-868](#) [SIMNA-915](#) [SIMNA-433](#) [W1044](#) [W1049B090](#) [A75-001](#) [WTL2449CQ1-FRSMM](#) [CPL9C](#) [EXB148BN](#) [0600-00060](#) [TRA9020S3PBN-001](#) [GD5W-28P-NF](#) [MA9-7N](#) [GD53-25](#) [GD5W-21P-NF](#) [C37](#) [MAF94051](#) [MA9-5N](#) [EXD420PL](#) [B1322NR](#) [QWFTB120](#) [MAF94271](#) [MAF94300](#) [GPSMB301](#) [FG4403](#) [AO-AGSM-OM54](#) [5200232](#) [MIKROE-2349](#) [WCM.01.0111](#) [MIKROE-2393](#) [MIKROE-2352](#) [MIKROE-2350](#)