



TAOGLAS®



Datasheet

Apex III

Part No:
TG.45.8113

Description:

Apex III Ultra-Wideband 5G/4G Dipole Terminal Antenna with 450MHz band
90° Hinged R/A SMA(M) Connector

Features:

- Highest efficiency for 450-6000MHz
- Fully 5G/4G Operational
- Dipole Swivel Terminal Antenna
- Hinged 90° termination with SMA(M) Connector
- Enhanced hinge design for vibration environments
- Dimensions: 218 * 58mm
- Connector Customizable
- RoHS & Reach Compliant

1. Introduction	3
2. Specifications	4
3. Antenna Characteristics	6
4. Radiation Patterns	8
5. Mechanical Drawing	21
6. Installation Guide	22
7. Packaging	23
<hr/>	
Changelog	24

Taoglas makes no warranties based on the accuracy or completeness of the contents of this document and reserves the right to make changes to specifications and product descriptions at any time without notice. Taoglas reserves all rights to this document and the information contained herein. Reproduction, use or disclosure to third parties without express permission is strictly prohibited.



1. Introduction



The Apex III TG.45 is a Wideband 5G/4G Dipole Antenna has been designed to cover all Cellular (including 5G), ISM and Wi-Fi working frequencies in the 600 to 6000MHz spectrum and includes 5G/4G Band 31 at 450MHz. Evolved from the already highly successful Apex II TG.35, the TG.45 has the highest wideband efficiency in its range of any terminal antenna on the market today. The extended lower frequency coverage at 450MHz makes the TG.45 ideal for IoT applications, such as remote monitoring of smart utilities.

The Apex III has been primarily designed for use with 5G/4G modules and devices that require the highest possible efficiency and peak gain to deliver best in class throughput on all major worldwide cellular bands (5G/4G/3G/2G) for access points, terminals and routers. High efficiency is vital for applications such as high speed video and real-time streaming or high capacity MIMO networks on public transportation.

This attractive slim-line antenna is ground plane independent, meaning it does not need to be connected to the ground-plane of a device to radiate efficiently. On the other hand, neither is it seriously detuned by connecting to a ground-plane, thus avoiding a problem notorious to smaller antennas.

It comes with a SMA(M) connector and swivel mechanism that allows the antenna to be rotated to fit in tight environments. The 90° hinge structure has been improved and strengthened so that the antenna in a 90° position would not drop down if used in environments prone to vibration.

The Apex III is backward compatible with 3G and 2G cellular applications such as HSPA, GSM, GPRS, UMTS, Wi-Fi and even has GPS included for Assisted GPS and/or E911 applications.

In summary, the Apex III is the ideal solution for any device requiring high, reliable performance. It will meet most type approval or carrier certification requirements from an efficiency standpoint. The antenna also makes an excellent reference antenna for test purposes. It has been designed as an omni-directional antenna and the radiation patterns prove this, being stable across all bands. Connector type is customizable and the housing is also available in white. Contact Taoglas regional customer support team for more information.

2. Specifications

Electrical													
Frequency (MHz)	LTE450	5G NR Band	LTE700	GSM 850/900	5G NR Band 74, 75, 76	GNSS	Band 3,9	Band 2,25,35,39	Band 1,23,66	LTE 2300	LTE 2600	5G NR Band 77, 78, 79	LTE5200 /Wi-Fi
	450 ~470	617 ~698	698 ~806	824 ~960	1427 ~1518	1561 ~1602	1710 ~1880	1850 ~1990	1920 ~2170	2305 ~2360	2490 ~2690	3300 ~3500	5150 ~5925
Efficiency (%)													
Straight	64.47	40.05	74.08	70.23	54.43	29.65	71.46	57.68	64.54	58.02	65.96	27.86	61.35
Bent	60.92	45.93	75.72	59.04	55.49	30.10	72.00	57.09	64.21	55.38	65.54	27.72	61.37
Peak Gain (dBi)													
Straight	1.46	-0.92	2.87	3.42	1.1	0.75	3.95	4.17	4.85	2.82	4.16	0.46	3.88
Bent	1.17	-0.37	2.77	2.8	0.57	0.56	2.82	3.63	4.57	2.50	3.76	-0.08	4.24
Average Gain (dB)													
Straight	-1.93	-4.41	-1.36	-1.19	-2.66	-5.39	-1.47	-2.53	-2.05	-2.42	-1.84	-5.69	-2.17
Bent	-2.16	-3.86	-1.23	-1.67	-1.58	-5.31	-1.43	-2.58	-2.07	-2.61	-1.88	-5.71	-2.16
Impedance	50Ω												
Polarization	Linear												
Radiation Pattern	Omnidirectional												
Max. input power	5 W												
Mechanical													
Casing	UV Resistant PC/ABS												
Connector	SMA Male Hinged 90°												
Weight	75g												
Recommended Torque for Mounting	0.9N·m												
Max torque for Mounting	1.176N·m												
Environmental													
Temperature Range	-40°C to 85°C												
Humidity	Non-condensing 65°C 95% RH												

5G/4G Bands			
Band Number	5G NR / FR1 / LTE / LTE-Advanced / WCDMA / HSPA / HSPA+ / TD-SCDMA		
	Uplink	Downlink	Covered
1	UL: 1920 to 1980	DL: 2110 to 2170	✓
2	UL: 1850 to 1910	DL: 1930 to 1990	✓
3	UL: 1710 to 1785	DL: 1805 to 1880	✓
4	UL: 1710 to 1755	DL: 2110 to 2155	✓
5	UL: 824 to 849	DL: 869 to 894	✓
7	UL: 2500 to 2570	DL: 2620 to 2690	✓
8	UL: 880 to 915	DL: 925 to 960	✓
9	UL: 1749.9 to 1784.9	DL: 1844.9 to 1879.9	✓
11	UL: 1427.9 to 1447.9	DL: 1475.9 to 1495.9	✓
12	UL: 699 to 716	DL: 729 to 746	✓
13	UL: 777 to 787	DL: 746 to 756	✓
14	UL: 788 to 798	DL: 758 to 768	✓
17	UL: 704 to 716	DL: 734 to 746 (LTE only)	✓
18	UL: 815 to 830	DL: 860 to 875 (LTE only)	✓
19	UL: 830 to 845	DL: 875 to 890	✓
20	UL: 832 to 862	DL: 791 to 821	✓
21	UL: 1447.9 to 1462.9	DL: 1495.9 to 1510.9	✓
22	UL: 3410 to 3490	DL: 3510 to 3590	✓
23	UL: 2000 to 2020	DL: 2180 to 2200 (LTE only)	✓
24	UL: 1625.5 to 1660.5	DL: 1525 to 1559 (LTE only)	✓
25	UL: 1850 to 1915	DL: 1930 to 1995	✓
26	UL: 814 to 849	DL: 859 to 894	✓
27	UL: 807 to 824	DL: 852 to 869 (LTE only)	✓
28	UL: 703 to 748	DL: 758 to 803 (LTE only)	✓
29	UL: -	DL: 717 to 728 (LTE only)	✓
30	UL: 2305 to 2315	DL: 2350 to 2360 (LTE only)	✓
31	UL: 452.5 to 457.5	DL: 462.5 to 467.5 (LTE only)	✓
32	UL: -	DL: 1452 - 1496	✓
35		1850 to 1910	✓
38		2570 to 2620	✓
39		1880 to 1920	✓
40		2300 to 2400	✓
41		2496 to 2690	✓
42		3400 to 3600	✓
43		3600 to 3800	✓
48		3550 to 3700	✓
66	UL: 1710-1780	DL: 2110-2200	✓
71		617 to 698	✓
74/75/76		1427 to 1518	✓
77		3300 to 4200	✓
78		3300 to 3800	✓
79		4400 to 5000	✓

3. Antenna Characteristics

3.1 Return Loss

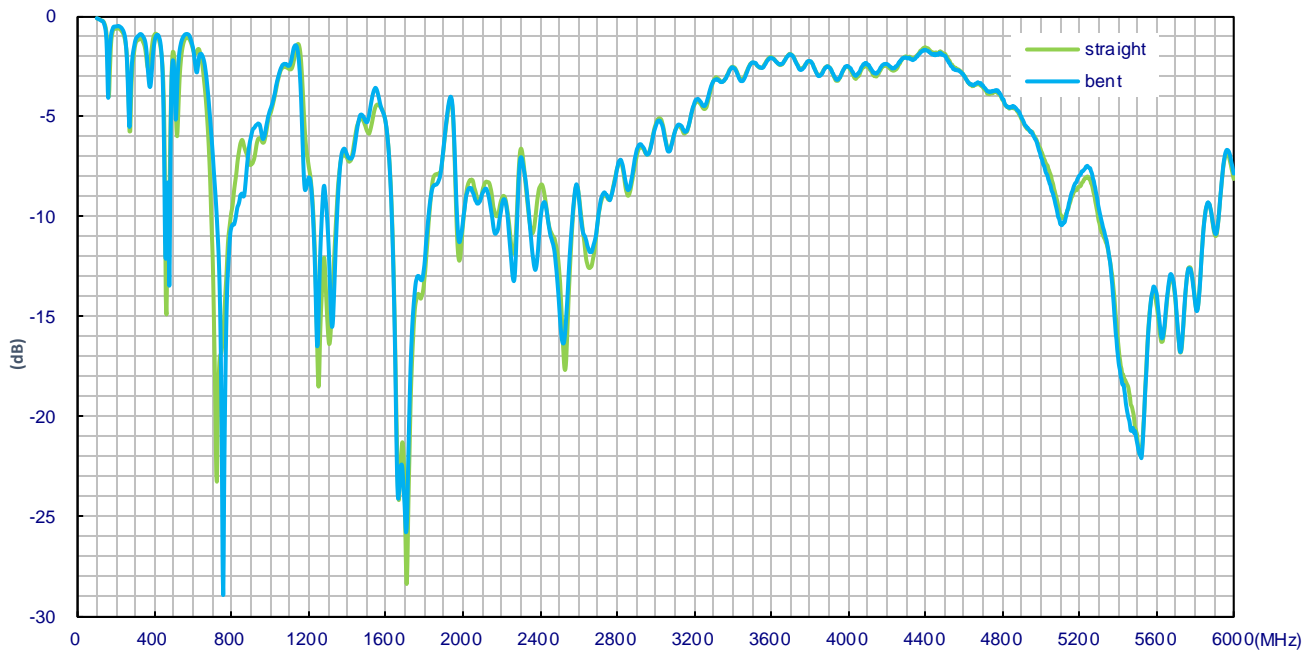

3.2 Efficiency

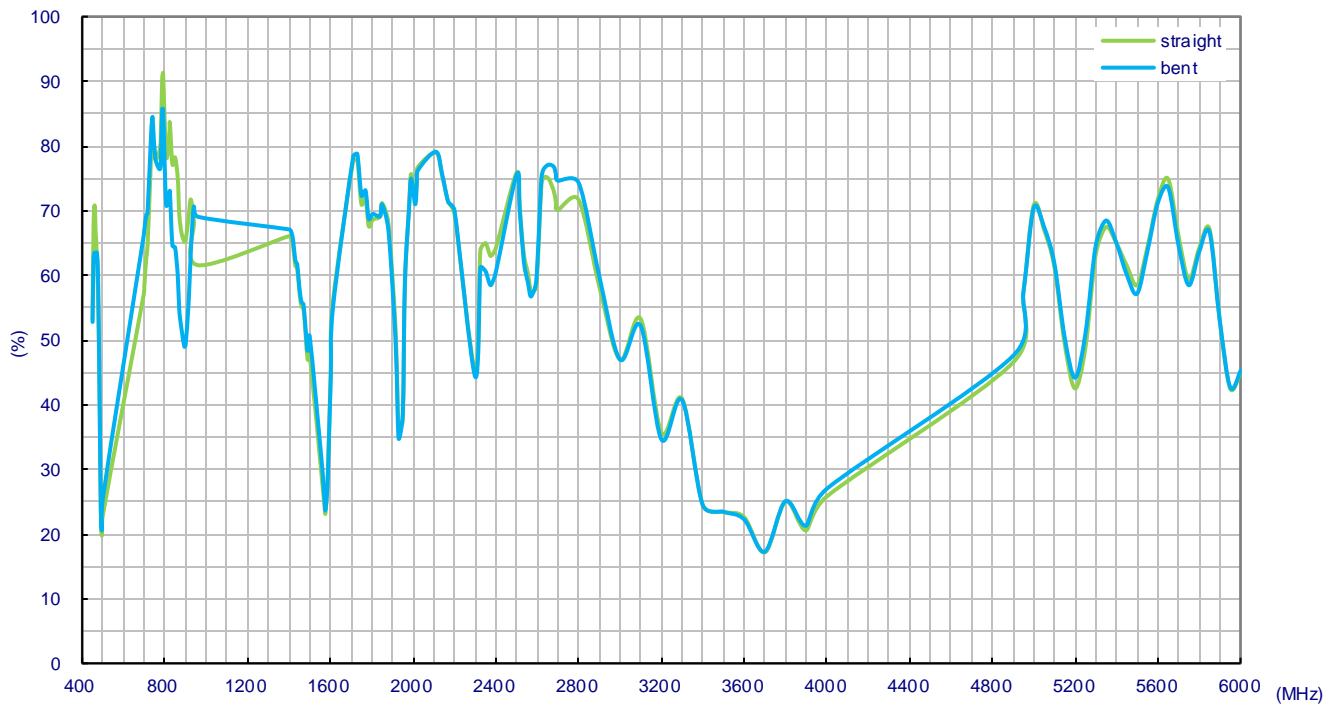

3.3 Average Gain

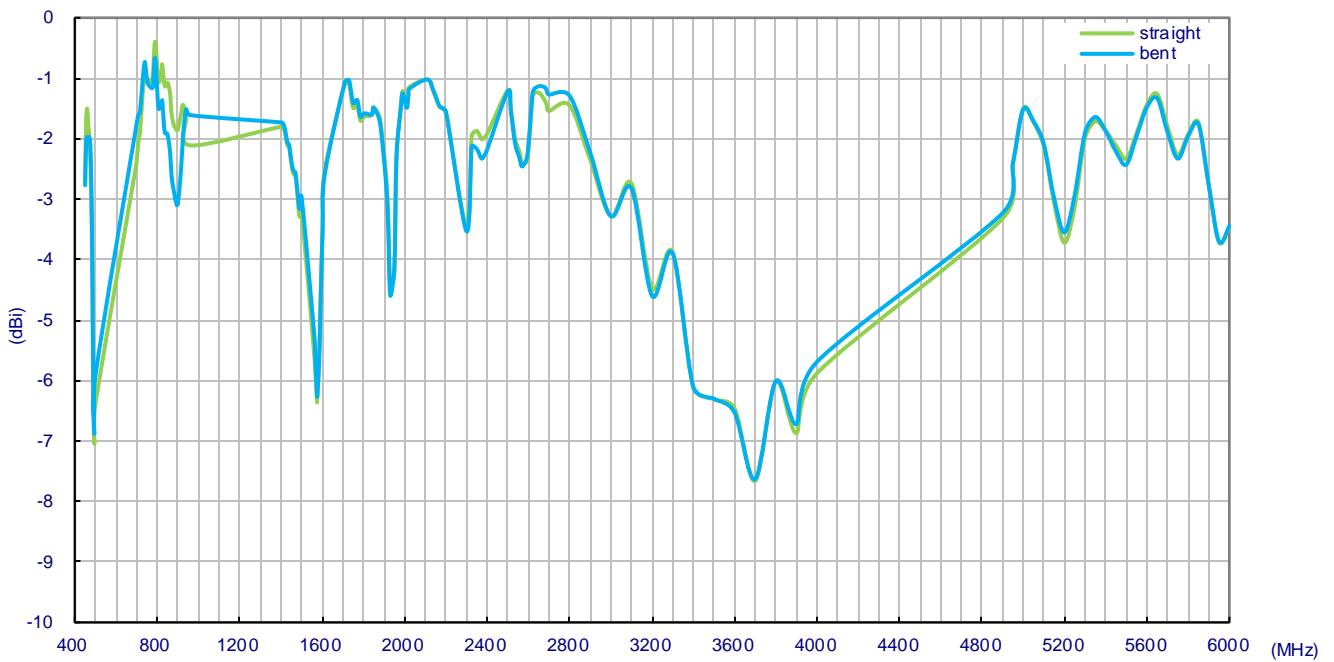

3.4 Peak Gain

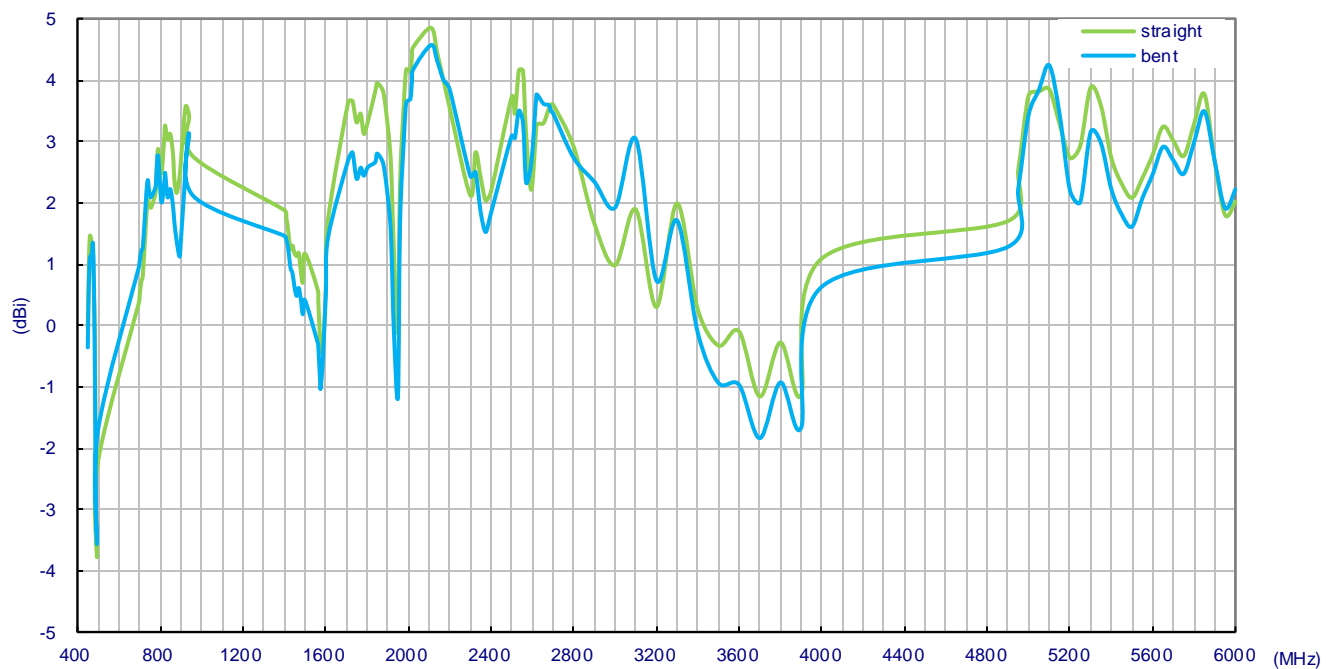

4. Radiation Patterns

4.1 Test Setup

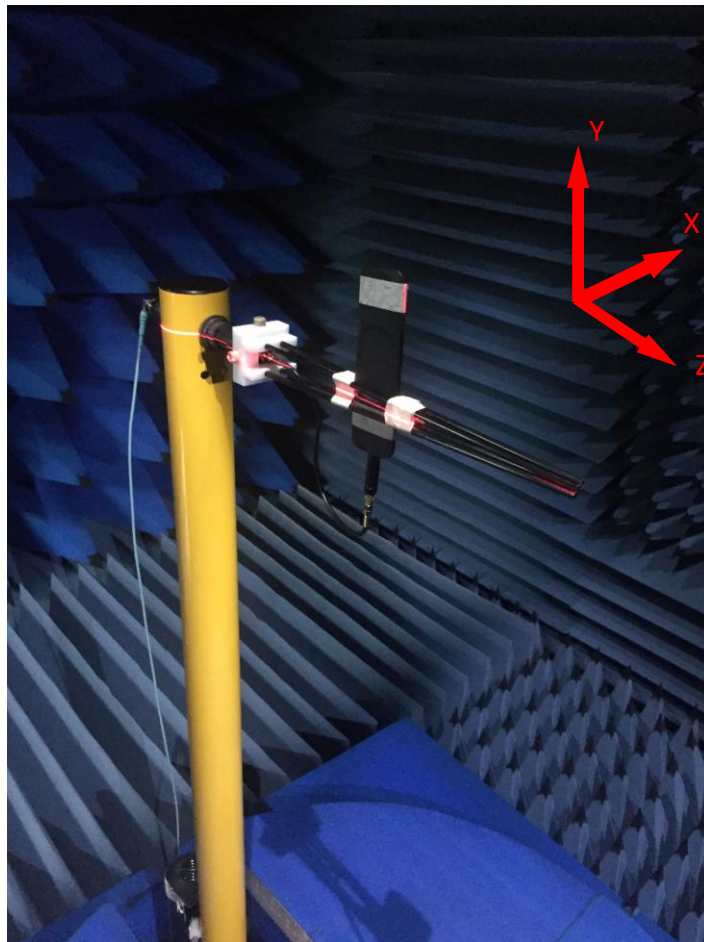

Free space

4.2 3D and 2D Radiation Patterns - Straight

450MHz

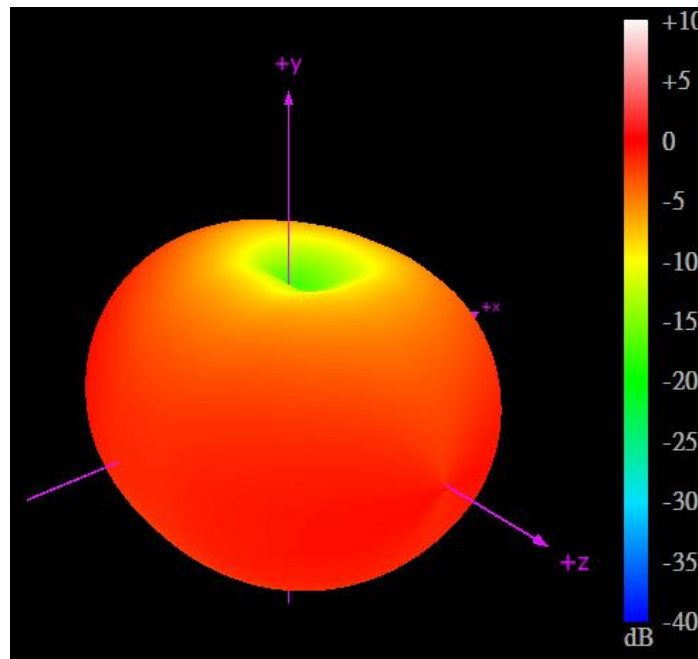

XY Plane

XZ Plane

YZ Plane

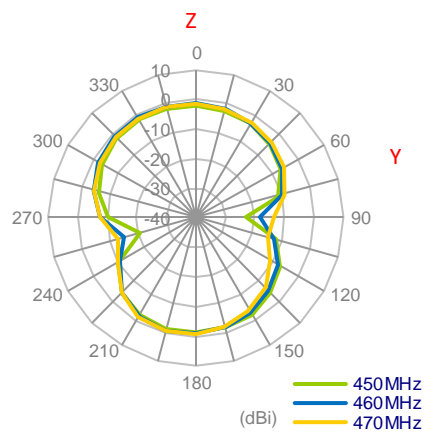
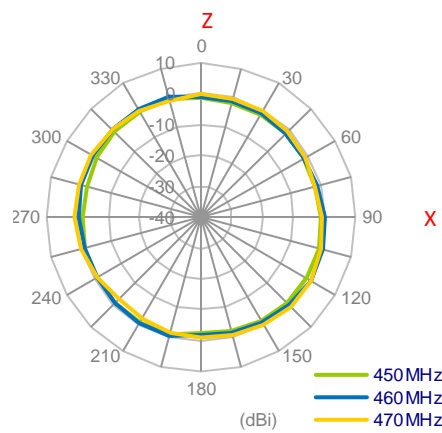
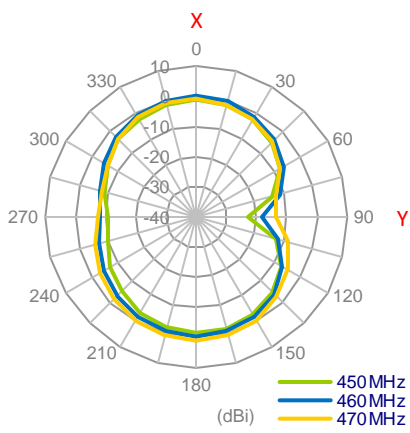

704MHz

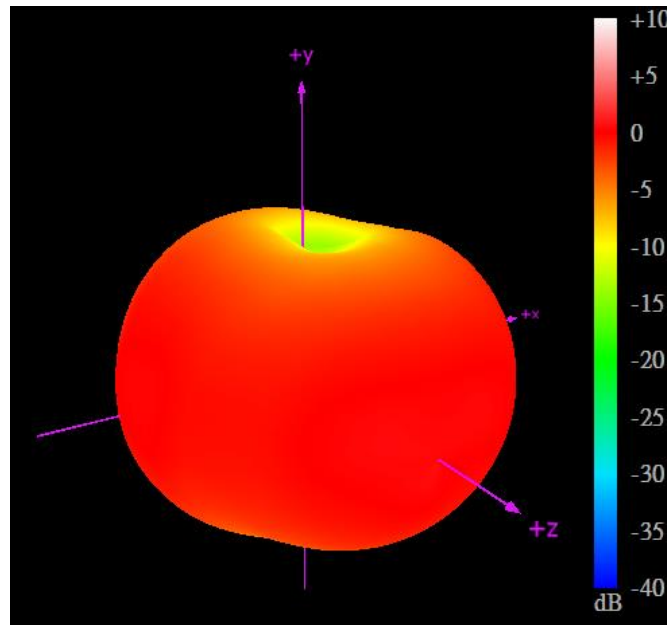

XY Plane

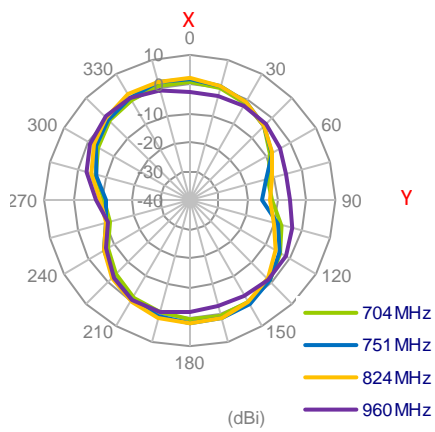

XZ Plane

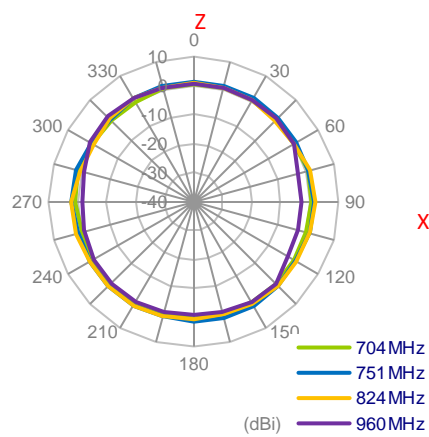

YZ Plane

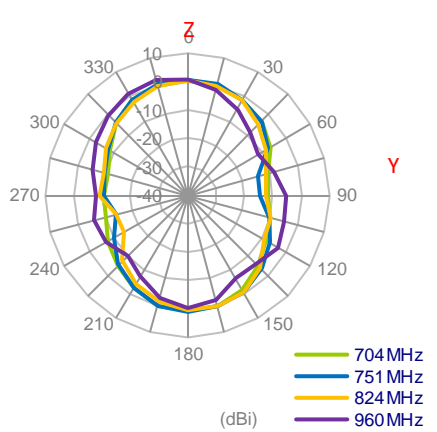

1575.42MHz

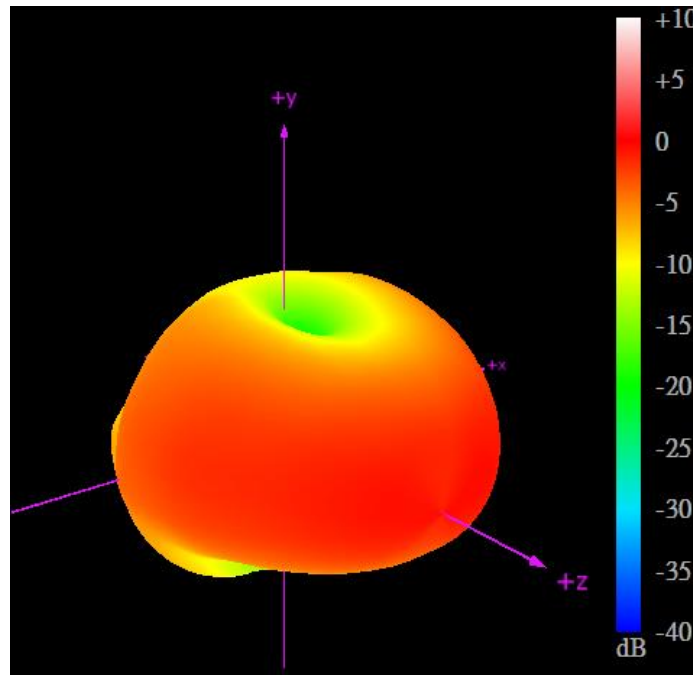

XY Plane

XZ Plane

YZ Plane

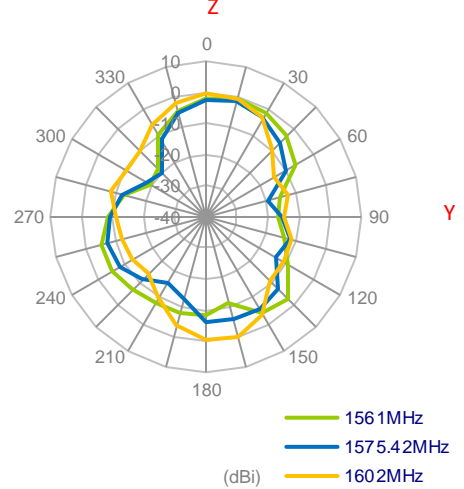
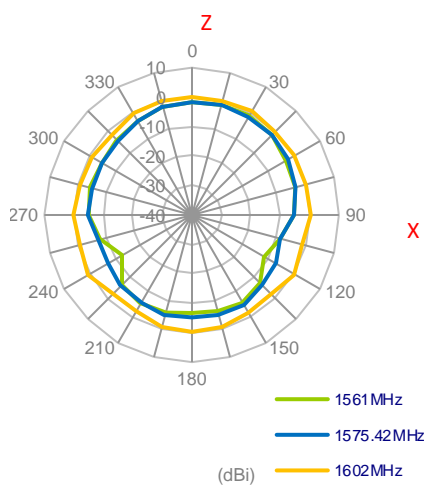
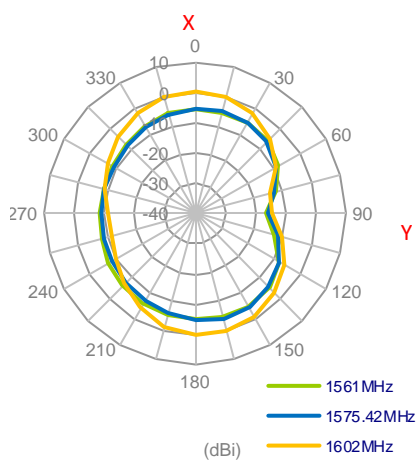

1710MHz

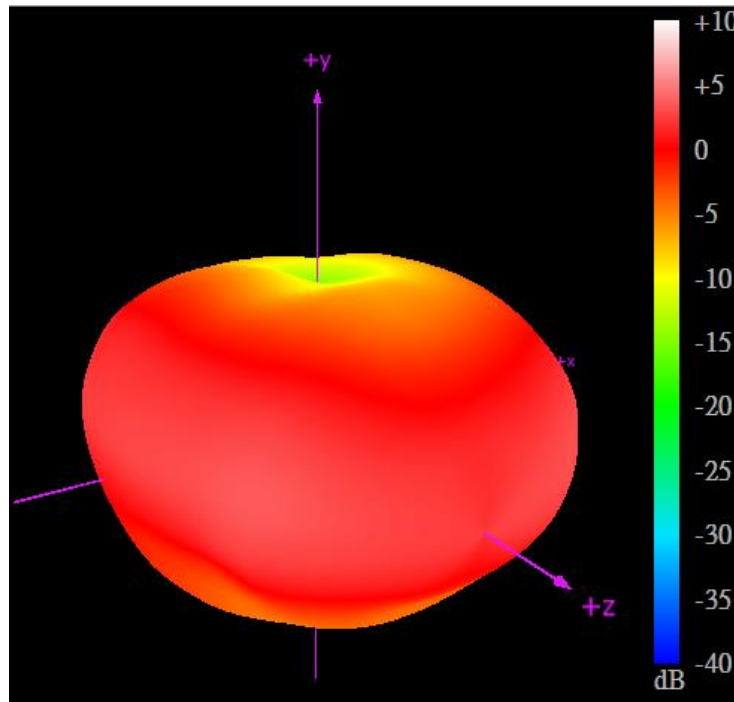

XY Plane

XZ Plane

YZ Plane

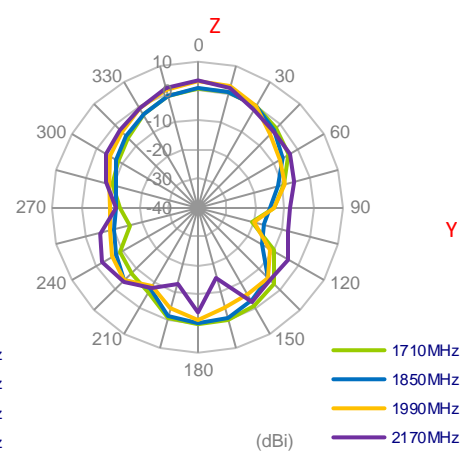
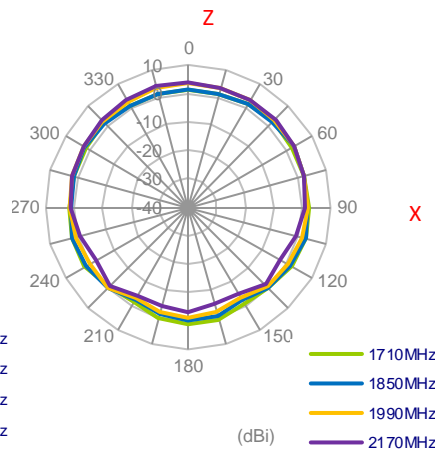
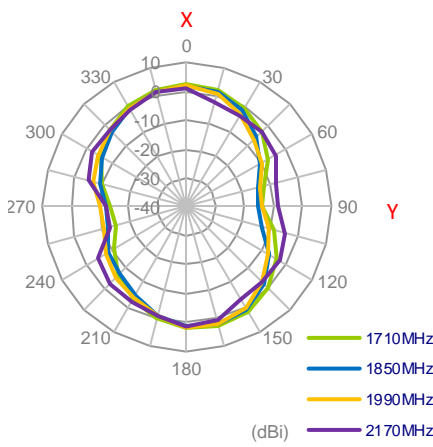

2300MHz

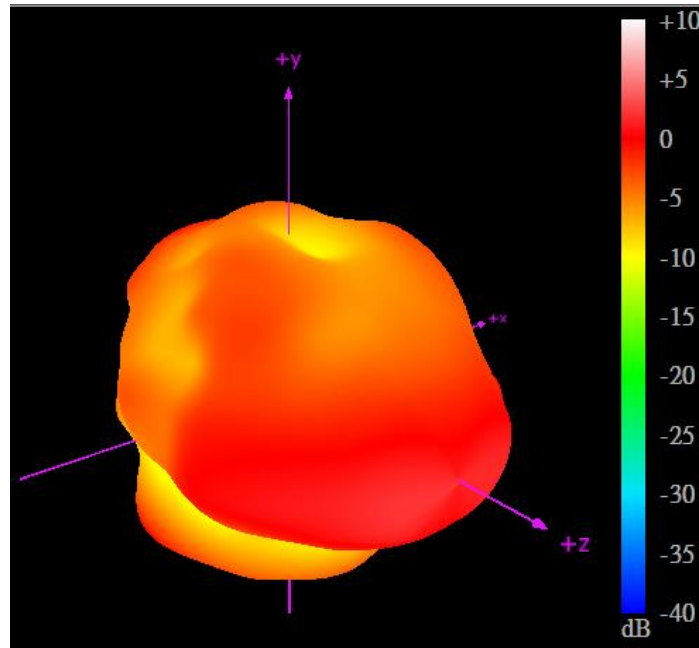

XY Plane

XZ Plane

YZ Plane

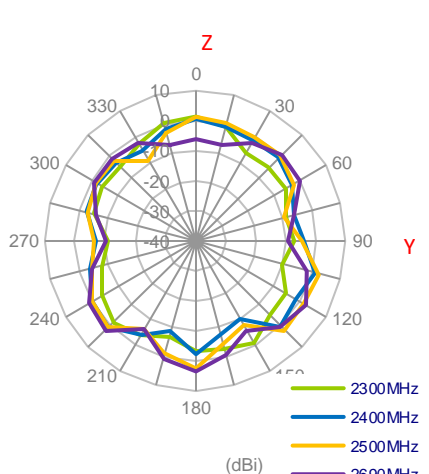
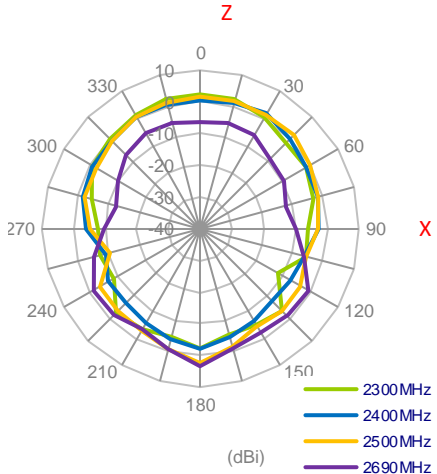
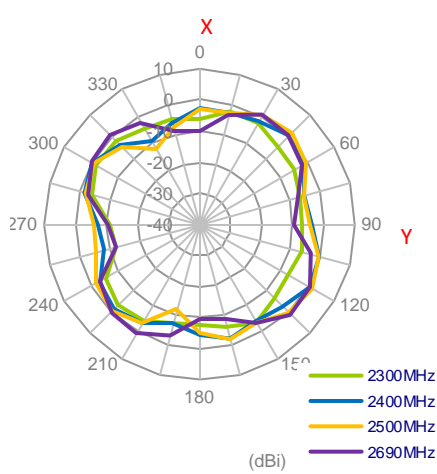

5850MHz

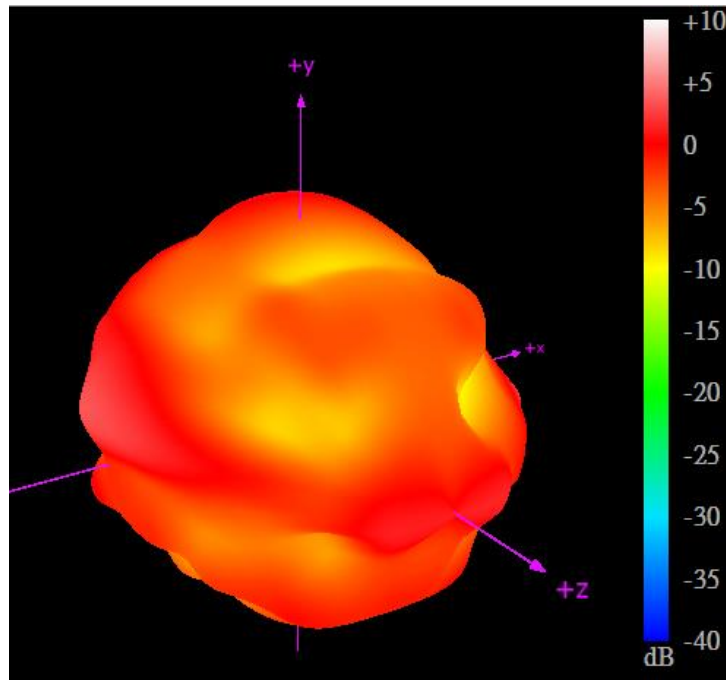

XY Plane

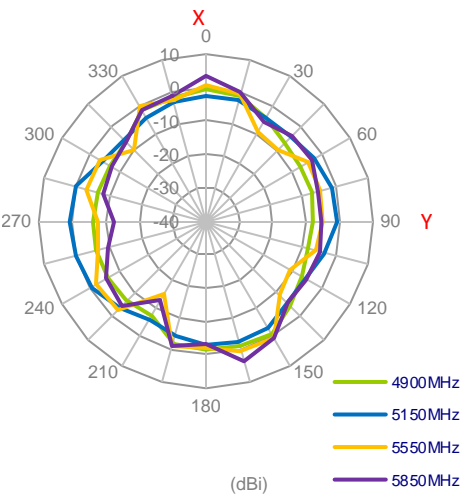

XZ Plane

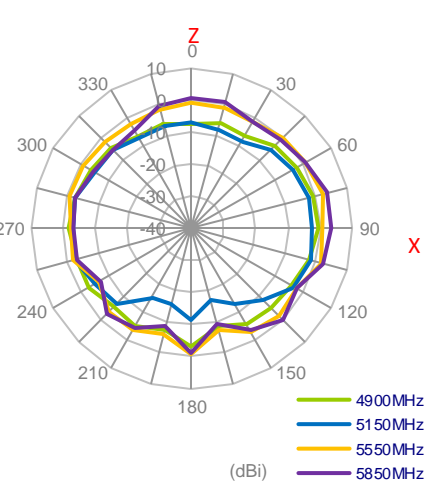

YZ Plane

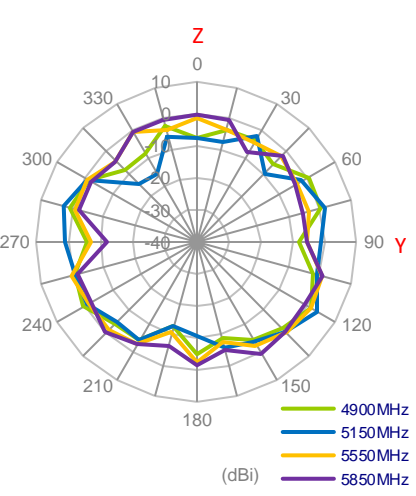

4.3 3D and 2D Radiation Patterns - Bent

450MHz

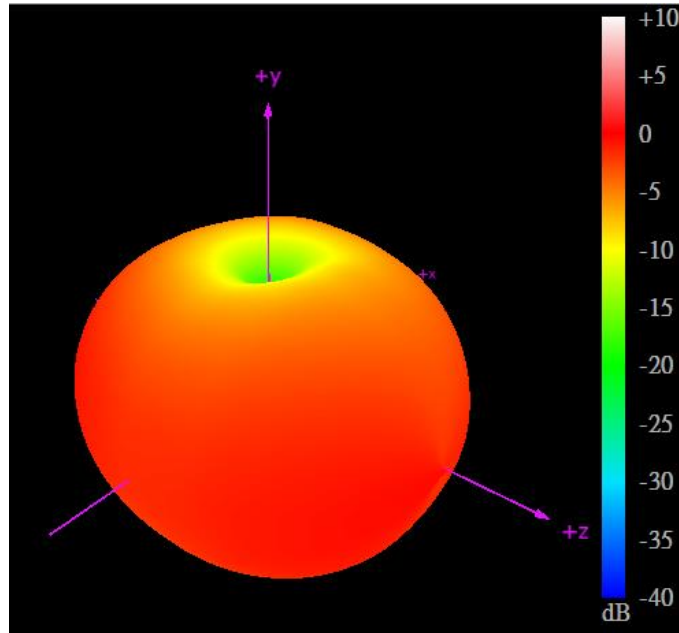

XY Plane

XZ Plane

YZ Plane

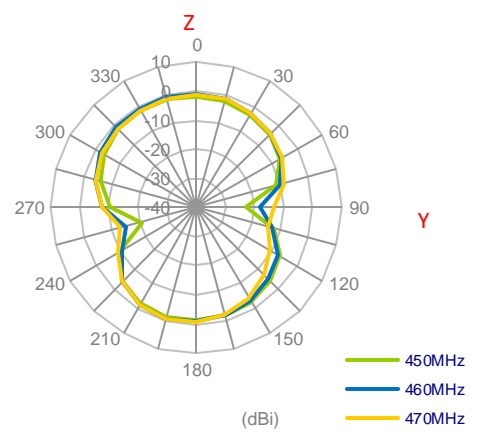
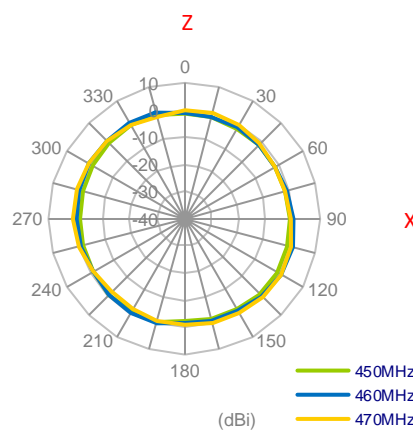
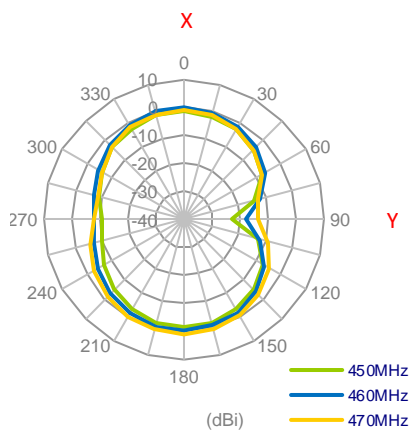

704MHz

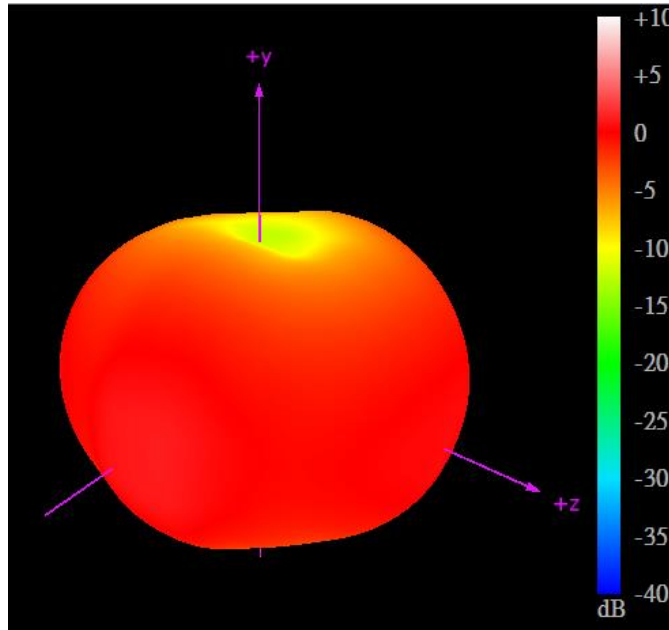

XY Plane

XZ Plane

YZ Plane

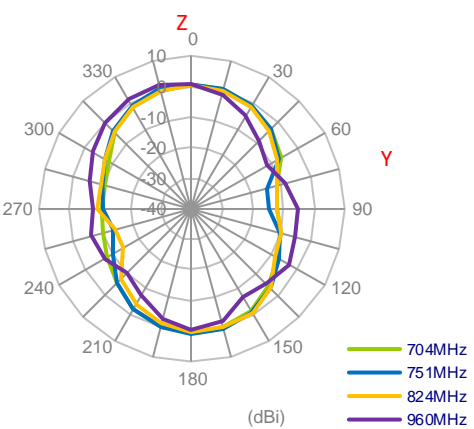
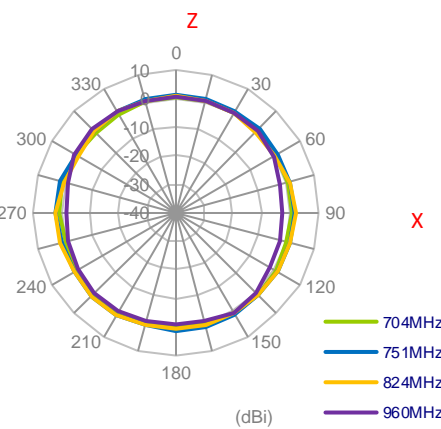
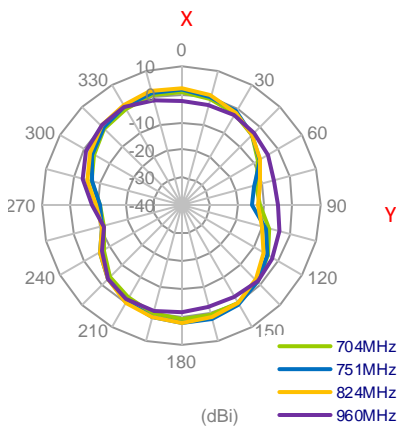

1575.42MHz

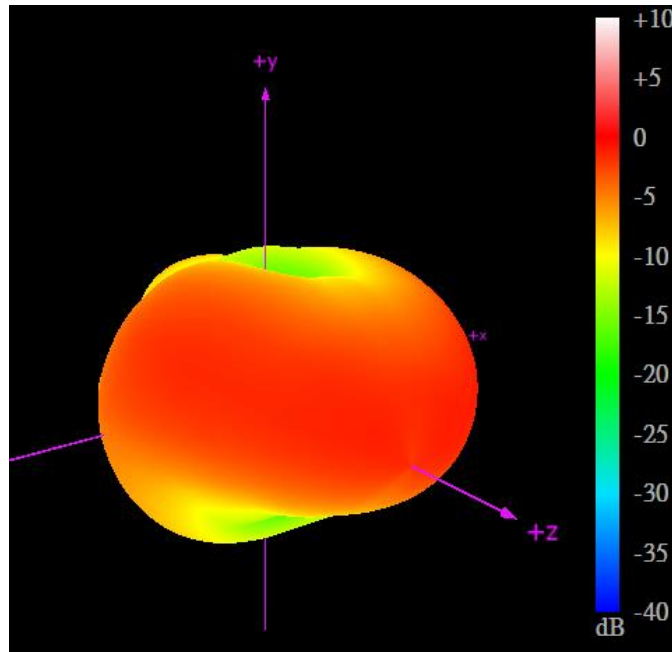

XY Plane

XZ Plane

YZ Plane

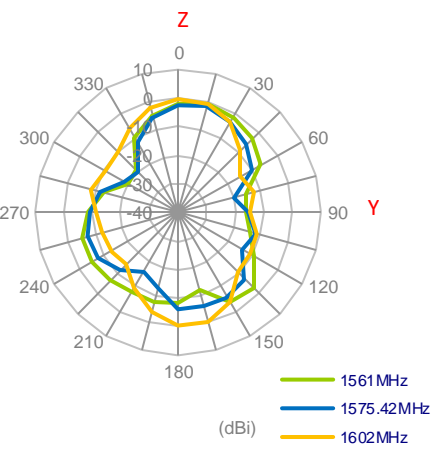
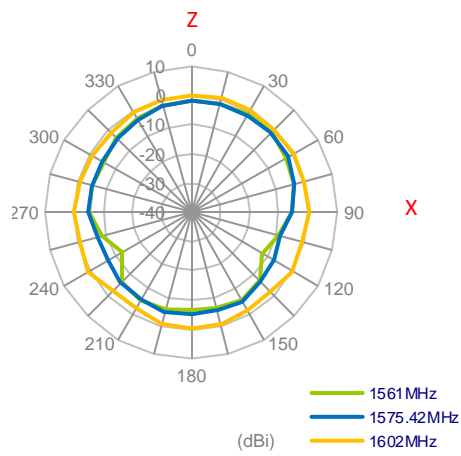
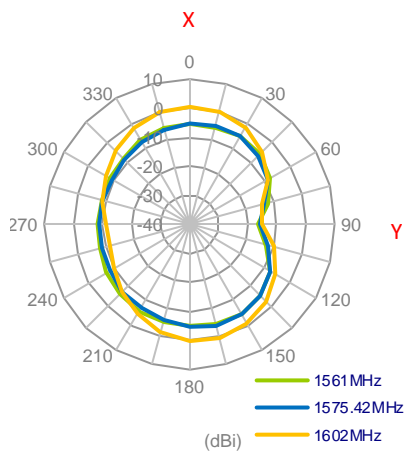

1710MHz

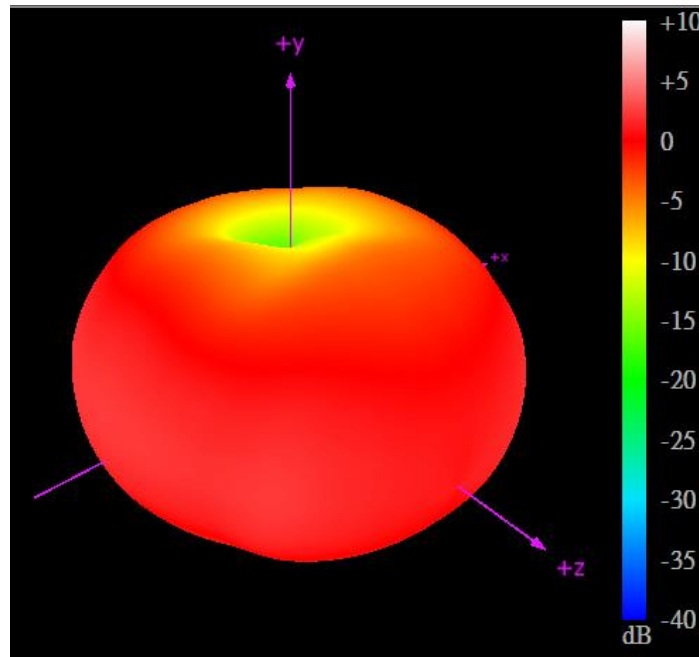

XY Plane

XZ Plane

YZ Plane

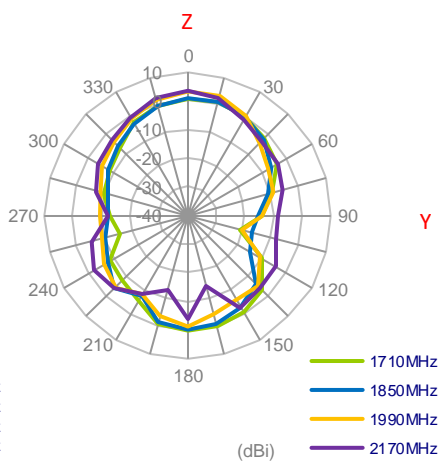
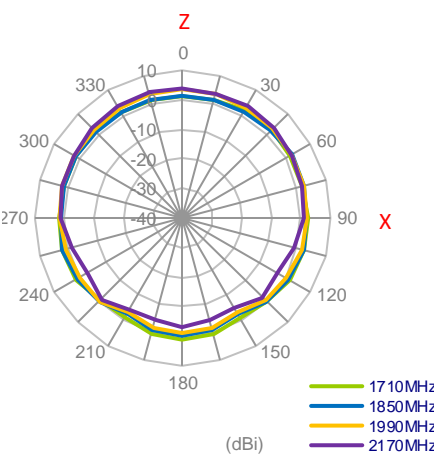
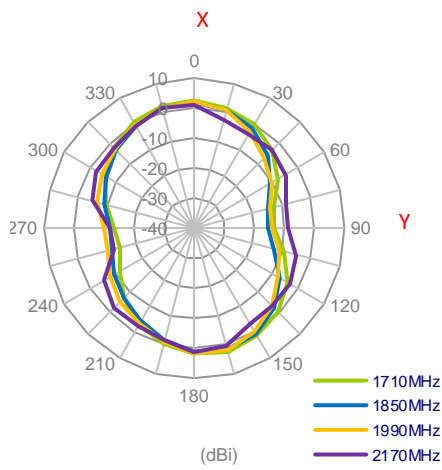

2300MHz

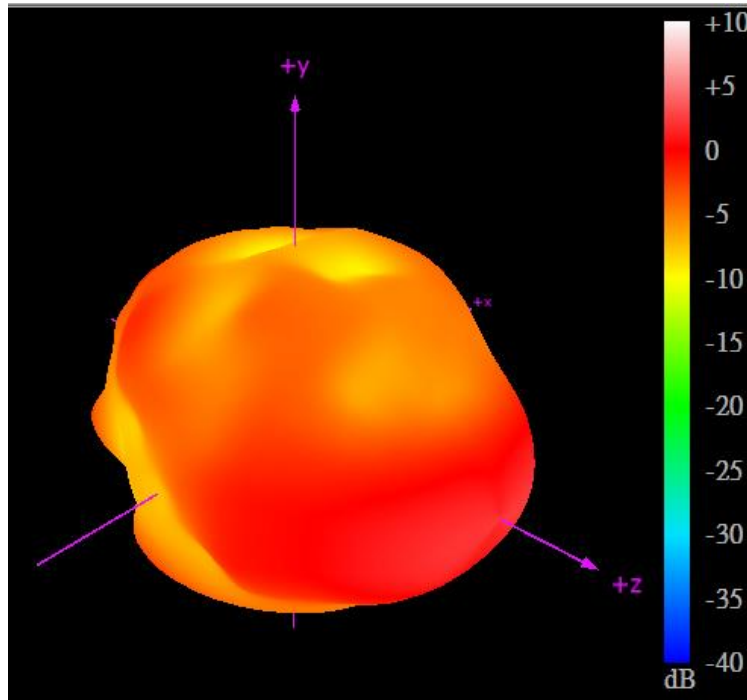

XY Plane

XZ Plane

YZ Plane

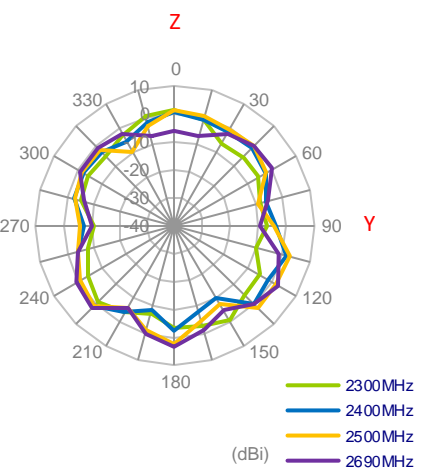
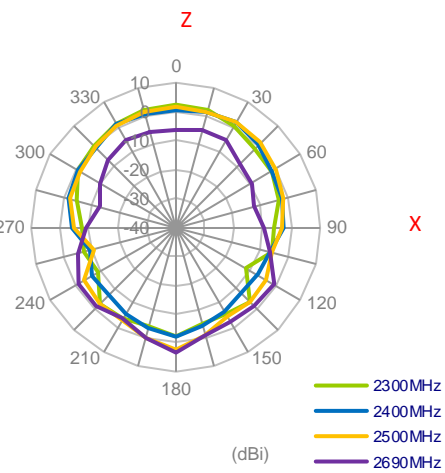
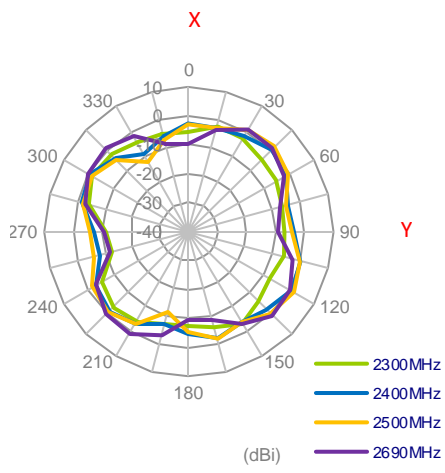

5850MHz

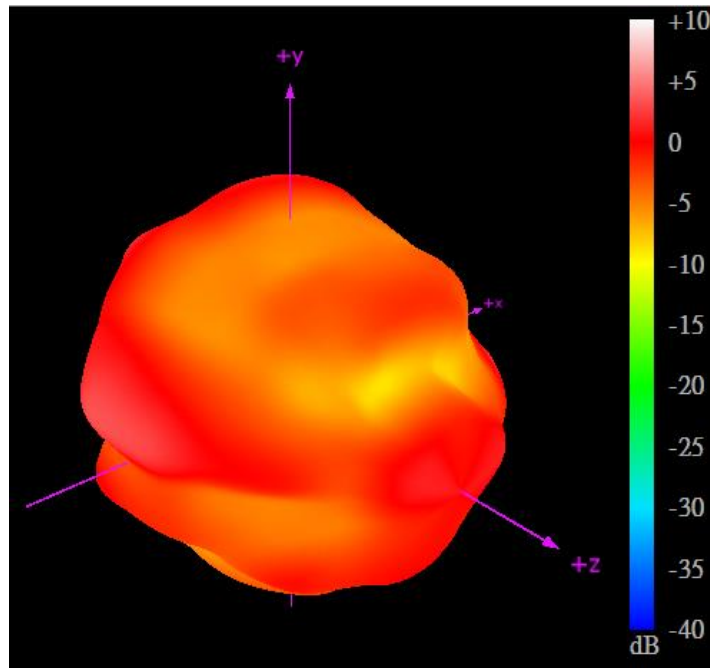

XY Plane

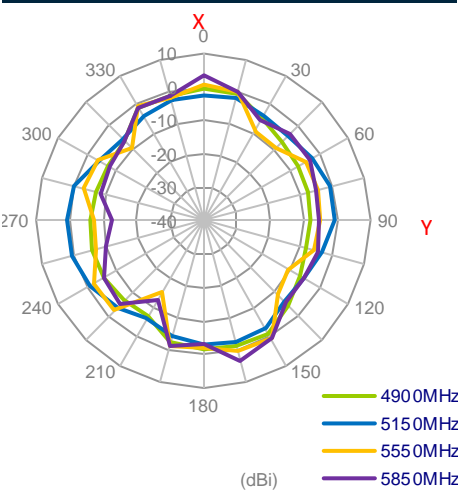

XZ Plane

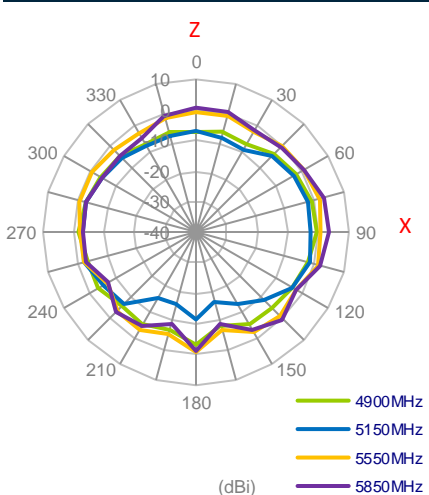

YZ Plane

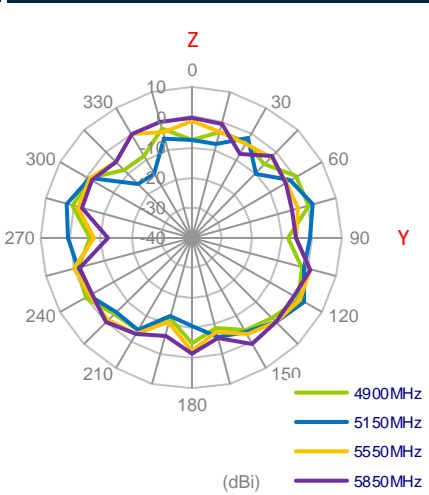

5. Mechanical Drawing (Units: mm)

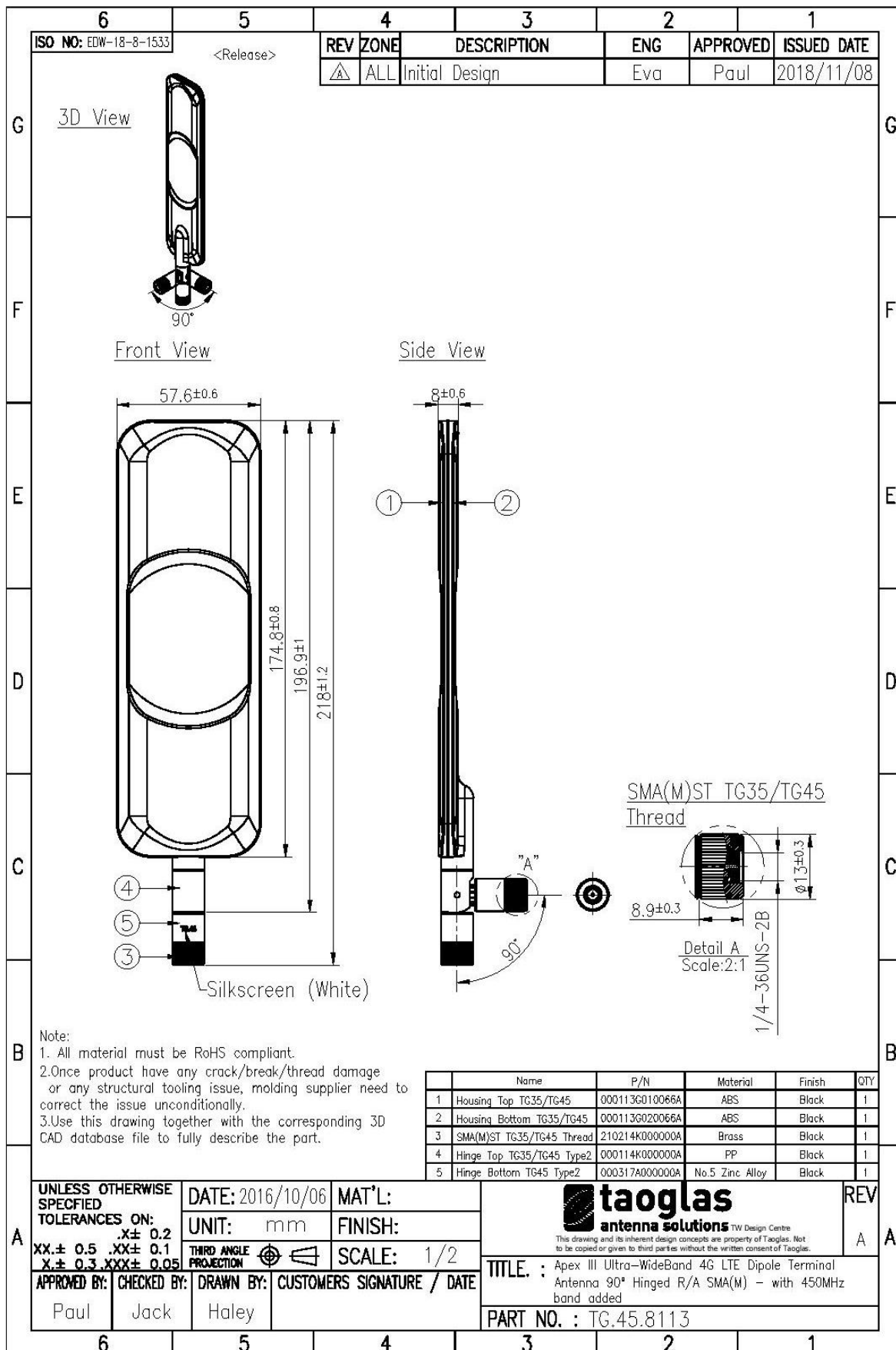

6. Installation Guide

TG.35/45 Installation Instructions

The TG.35/45 antenna has an independent rotating SMA connector, which enables users to install the antenna in a preferable direction. After tightening the SMA connector, the antenna will sit firmly on users' base/router either on a table or on a wall. This installation sheet illustrates using the TG.35/45 on a wall mounted device as an example.

Step 1.

Adjust the antenna to preferable direction, then mount the SMA(M) connector on devices SMA(F) connector. (See figure 1)

Step 2.

Hold the antenna housing with one hand, while rotating the SMA(M) connector with the other hand until the connector is tight. If the connector was tightened properly, the antenna will keep its position without slipping down. (See figure 2)

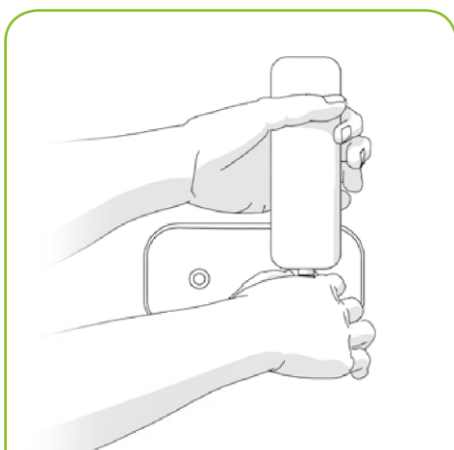

Figure 1. Place the TG.35/45 antenna onto the connector of the device and hold the antenna in the preferred orientation.

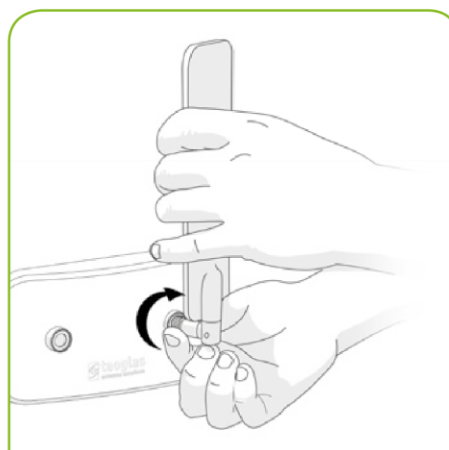

Figure 2. Fix the connector to the device by twisting the rotating head of the SMA connector until it is tight enough to hold the antenna in the correct position.

www.taoglas.com/tg35-tg45-installation-instructions/

7. Packaging

1pc TG.45.8113 per Small PE Bag with Video Link label
 Dimensions: 100*280mm
 Weight: 73.5g



25pcs per Large PE Bag
 Dimensions: 280*430mm
 Weight: 1.85Kg

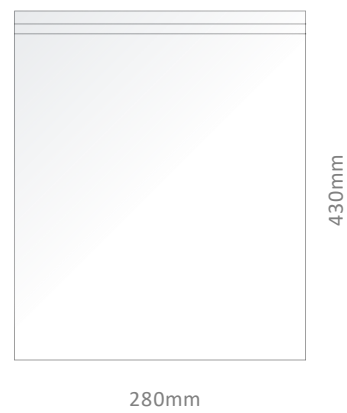

75pcs TG.45.8113 per Carton
 Carton Dimensions: 330*260*300mm
 Weight: 6.1Kg

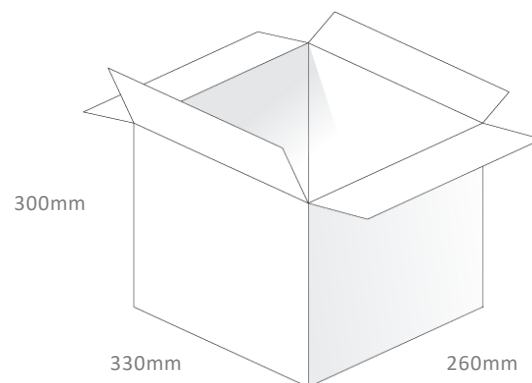

Changelog for the datasheet

SPE-17-8-079 – TG.45.8113

Revision: C (Current Version)

Date:	2019-10-03
Changes:	Updated to include 5G
Changes Made by:	Jack Conroy

Previous Revisions

Revision: B

Date:	2018-12-18
Changes:	Introduction Updated
Changes Made by:	Jack Conroy

Revision: A (Original First Release)

Date:	2017-08-10
Notes:	
Author:	Your Name Here



TAOGLAS®

www.taoglas.com



X-ON Electronics

Largest Supplier of Electrical and Electronic Components

Click to view similar products for [Antennas](#) category:

Click to view products by [Taoglas](#) manufacturer:

Other Similar products are found below :

[GAN30084EU](#) [930-033-R](#) [GW17.07.0250E](#) [1513563-1](#) [EXE902SM](#) [APAMPG-117](#) [MAF94383](#) [W3908B0100](#) [W6102B0100](#) [YE572113-30RSMM](#) [108-00014-50](#) [66089-2406](#) [SPDA17RP918](#) [A09-F8NF-M](#) [A09-F5NF-M](#) [RGFRA1903041A1T](#) [W3593B0100](#) [W3921B0100](#) [SIMNA-868](#) [SIMNA-915](#) [SIMNA-433](#) [W1044](#) [W1049B090](#) [A75-001](#) [WTL2449CQ1-FRSMM](#) [CPL9C](#) [EXB148BN](#) [0600-00060](#) [TRA9020S3PBN-001](#) [Y4503](#) [GD5W-28P-NF](#) [MA9-7N](#) [GD53-25](#) [GD5W-21P-NF](#) [C37](#) [MAF94051](#) [MA9-5N](#) [EXD420PL](#) [B1322NR](#) [QWFTB120](#) [MAF94271](#) [MAF94300](#) [GPSMB301](#) [FG4403](#) [AO-AGSM-OM54](#) [5200232](#) [MIKROE-2349](#) [WCM.01.0111](#) [MIKROE-2393](#) [MIKROE-2352](#)