



TAOGLAS®



Datasheet

GuardianX 9 in 1 Antenna

Part No:
MA9909.A.002

Description:

1*Active GNSS with RG-174 & SMA(M)
8*Cellular MIMO with TGC-200 & SMA(M)

Features:

Low-profile Adhesive Mount Multi-antenna
1* GPS-GLONASS Antenna
8* Cellular MIMO
Worldwide 4G Bands
Covers 5G Band 71
IP67 Rated Waterproof Enclosure
Cables: 1M Low Loss TGC-200 and RG-174
Connectors: SMA(M)
Dimensions: 360 * 160 * 16.5mm
RoHS & REACH Compliant

1. Introduction	3
2. Specifications	4
3. Active Antenna Characteristics	9
4. Antenna Characteristics	15
5. Radiation Patterns	20
6. Mechanical Drawing	69
7. Packaging	70
<hr/>	
Changelog	71

Taoglas makes no warranties based on the accuracy or completeness of the contents of this document and reserves the right to make changes to specifications and product descriptions at any time without notice. Taoglas reserves all rights to this document and the information contained herein. Reproduction, use or disclosure to third parties without express permission is strictly prohibited.



1. Introduction



The Taoglas GuardianX MA9909 is a low profile heavy duty, fully IP67 rated waterproof, adhesive external combination antenna. It combines 9 antenna elements into one enclosure, 1 GPS/GLONASS/Galileo, 8* Cellular MIMO (698 to 960MHz/1710 to 2170MHz/ 2490 to 2690MHz/ 3300 to 3600MHz). The Taoglas GuardianX has been designed as a low profile solution for several IoT and Automotive applications where space is at a premium.

This unique product delivers powerful worldwide 4G LTE MIMO antenna technology at 700MHz/800MHz/1700MHz/1800MHz/2600MHz and GNSS. This is an ideal external combination antenna solution that is used where drilling a hole through the roof of a vehicle or a metal panel for an external antenna is not feasible. The GuardianX can operate at band 71 a newly established 5G band at 600MHz.

Typical applications include:

- Passenger Bus / Rail / Air Applications.
- Automotive and Heavy Equipment Vehicle Tracking and Telematics
- Remote Asset and Pipeline Monitoring
- HD Video over LTE
- First Responder and Emergency Services
- M2M Applications/IoT

5G/4G applications demand high speed data uplink and downlink. High efficiency and high gain MIMO antennas are necessary to achieve the required signal to noise ratio and throughput required to solve these challenges. Taoglas also takes care to have high isolation between the two MIMO antennas to prevent self-interference. Low loss cables are used to keep efficiency high over long cable lengths. In contrast, smaller MIMO antennas with poorer quality thinner cables will have much reduced efficiency and isolation, which would lead to a large drop in system throughput, increased number of drops, and may indeed not make a system connection at all.

Cable length and connector types are customizable. Contact your regional Taoglas customer support team for more information.

2. Specifications

GNSS Frequency Bands Covered							
GPS/QZSS	L1 1575.42MHz	L2 1227.6MHz	L5 1176.45MHz	L6 1278.75MHz			
	■	□	□	□			
GLONASS	L5R 1176.45MHz	L3PT 1201.5MHz	L2PT 1246MHz	L1CR 1575.42MHz	L1PT 1602MHz		
	□	□	□	■	■		
Galileo	E5a 1176.45MHz	E5b 1201.5MHz	E4 1215MHz	E3 1256MHz	E6 1278.75MHz	E2 1561MHz	L1 1575.42MHz
	□	□	□	□	□	□	■
BeiDou	B1 1561MHz	B2 1207.14MHz	B3 1268.52MHz				
	□	□	□				
Compass	E5B(B2)/ E6(B3) 1268.56MHz	E2(B1) 1561MHz					
	□	□					
SBAS	Omnistar 1542.5MHz	WAAS/EGN OS 1575.42MHz					
	□	■					

GNSS Electrical		
Frequency (MHz)	1575.42	1602
VSWR (max.)	2.0:1	2.0:1
Peak Gain at Zenith (dBic)	1.5	0
Axial Ratio (dB)	6	14
Polarization	RHCP	
Impedance	50Ω	

LNA and Filter Electrical Properties		
Frequency (MHz)	1575.42	1602
VSWR (max.)	2.0:1	2.0:1
Gain@1.8V (dBic)	25	25
Gain@3.0V (dBic)	31	31
Gain@5.5V (dBic)	34	34
Noise@1.8V (dB)	3	3
Noise@3.0V (dB)	3	3
Noise@5.5V (dB)	3.3	3.3
Power consumption@1.8V (mA)	5	
Power consumption@3.0V (mA)	10	
Power consumption@5.5V (mA)	23	
Total Specification (Through Antenna, SAW Filter and LNA)		
Frequency (MHz)	1575.42	1602
Gain@3V (dBic)	31 ± 3	30 ± 3
Output Impedance	50 Ω	

5G/4G Antenna											
Frequency (MHz)	5G NR Band 71		LTE700	GSM 850/900	5G NR Band 74, 75, 76	DCS	PCS	UMTS1	LTE2600	5G NR Band 77, 78, 79	LTE5200/Wi-Fi 5800
	617 ~698	698 ~824	824 ~960	1427 ~1518	1710 ~1880	1850 ~1990	1920 ~2170	2300 ~2690	3300 ~3500	5150 ~5925	
Efficiency (%)											
MIMO 1	1m	35.41	42.11	44.33	18.89	52.83	48.11	47.82	43.25	10.60	16.05
MIMO 2	1m	13.76	30.02	24.81	25.80	54.18	59.28	59.20	34.24	20.71	9.52
MIMO 3	1m	36.90	42.56	42.53	27.82	57.08	54.93	53.95	32.99	17.13	12.53
MIMO 4	1m	27.71	32.84	29.33	41.72	43.61	36.50	34.63	40.21	13.29	9.87
MIMO 5	1m	30.28	31.92	30.10	43.43	48.18	40.97	38.80	42.42	14.18	9.94
MIMO 6	1m	35.45	43.01	45.05	29.32	60.41	59.52	58.29	38.87	16.88	11.95
MIMO 7	1m	13.41	30.93	27.21	25.04	57.83	61.70	62.69	36.90	21.87	9.96
MIMO 8	1m	41.17	44.90	49.33	20.44	53.31	52.45	51.09	44.85	10.88	15.73
Average Gain (dB)											
MIMO 1	1m	-4.54	-3.76	-3.55	-7.25	-2.77	-3.18	-3.21	-3.66	-9.76	-8.12
MIMO 2	1m	-9.02	-5.30	-6.06	-5.91	-2.67	-2.28	-2.29	-4.67	-6.84	-10.24
MIMO 3	1m	-4.35	-3.72	-3.72	-5.66	-2.44	-2.60	-2.69	-4.84	-7.68	-9.09
MIMO 4	1m	-5.61	-4.84	-5.37	-3.80	-3.61	-4.39	-4.62	-3.96	-8.78	-10.15
MIMO 5	1m	-5.23	-4.96	-5.26	-3.63	-3.18	-3.89	-4.13	-3.73	-8.50	-10.07
MIMO 6	1m	-4.53	-3.67	-3.47	-5.43	-2.20	-2.26	-2.35	-4.14	-7.76	-9.30
MIMO 7	1m	-9.07	-5.14	-5.66	-6.05	-2.40	-2.11	-2.03	-4.35	-6.63	-10.07
MIMO 8	1m	-3.88	-3.49	-3.07	-6.90	-2.73	-2.81	-2.93	-3.52	-9.67	-8.19
Peak Gain (dBi)											
MIMO 1	1m	-0.30	0.42	1.35	-3.07	2.56	1.99	1.46	1.26	-5.72	-1.93
MIMO 2	1m	-4.26	-1.30	-2.64	-0.30	1.04	1.29	2.33	0.59	-2.54	-4.93
MIMO 3	1m	-0.41	0.59	-0.15	-0.77	2.62	2.74	2.68	-0.55	-2.67	-3.38
MIMO 4	1m	0.04	0.52	-0.34	0.73	1.20	1.22	1.30	1.04	-2.90	-5.29
MIMO 5	1m	0.22	0.84	0.05	0.34	1.80	2.32	1.95	2.07	-2.48	-4.94
MIMO 6	1m	-0.83	0.62	0.13	-1.13	2.64	3.00	3.13	0.41	-3.08	-4.01
MIMO 7	1m	-4.11	-0.57	-2.04	-0.53	1.20	1.53	2.50	0.35	-2.66	-4.73
MIMO 8	1m	0.70	1.42	1.99	-2.78	2.49	2.19	1.55	1.24	-5.64	-1.87
Impedance		50 Ω									
Polarization		Linear									
Radiation Pattern		Omni									
Max. input power		2W									

Mechanical	
Dimension	360 * 160 * 16.5mm
Casing	PC
Cable	1M TGC200 for Cellular – Fully Customizable 1M RG174 for GNSS – Fully Customizable
Connector	Cellular 5G/4G: SMA-Plug – Fully Customizable GNSS: SMA-Plug – Fully Customizable
Sealant	Rubber Stopper
Weight Including Cables	1060g
Environmental	
Protection	IP67
Temperature Range	-40°C to 85°C
Humidity	Non-condensing 65°C 95% RH
Cable Pull	RG174 4KgF/ TGC200 9KgF

5G/4G Bands										
Band Number	5GNR / FR1 / LTE / LTE-Advanced / WCDMA / HSPA / HSPA+ / TD-SCDMA									
	Uplink	Downlink	1	2	3	4	5	6	7	8
1	UL: 1920 to 1980	DL: 2110 to 2170	✓	✓	✓	✓	✓	✓	✓	✓
2	UL: 1850 to 1910	DL: 1930 to 1990	✓	✓	✓	✓	✓	✓	✓	✓
3	UL: 1710 to 1785	DL: 1805 to 1880	✓	✓	✓	✓	✓	✓	✓	✓
4	UL: 1710 to 1755	DL: 2110 to 2155	✓	✓	✓	✓	✓	✓	✓	✓
5	UL: 824 to 849	DL: 869 to 894	✓	✓	✓	✓	✓	✓	✓	✓
7	UL: 2500 to 2570	DL: 2620 to 2690	✓	✓	✓	✓	✓	✓	✓	✓
8	UL: 880 to 915	DL: 925 to 960	✓	✓	✓	✓	✓	✓	✓	✓
9	UL: 1749.9 to 1784.9	DL: 1844.9 to 1879.9	✓	✓	✓	✓	✓	✓	✓	✓
11	UL: 1427.9 to 1447.9	DL: 1475.9 to 1495.9	✓	✓	✗	✓	✓	✗	✓	✓
12	UL: 699 to 716	DL: 729 to 746	✓	✓	✓	✓	✓	✓	✓	✓
13	UL: 777 to 787	DL: 746 to 756	✓	✓	✓	✓	✓	✓	✓	✓
14	UL: 788 to 798	DL: 758 to 768	✓	✓	✓	✓	✓	✓	✓	✓
17	UL: 704 to 716	DL: 734 to 746	✓	✓	✓	✓	✓	✓	✓	✓
18	UL: 815 to 830	DL: 860 to 875	✓	✓	✓	✓	✓	✓	✓	✓
19	UL: 830 to 845	DL: 875 to 890	✓	✓	✓	✓	✓	✓	✓	✓
20	UL: 832 to 862	DL: 791 to 821	✓	✓	✓	✓	✓	✓	✓	✓
21	UL: 1447.9 to 1462.9	DL: 1495.9 to 1510.9	✓	✓	✗	✓	✓	✗	✓	✓
22	UL: 3410 to 3490	DL: 3510 to 3590	✓	✓	✓	✓	✓	✓	✓	✓
23	UL: 2000 to 2020	DL: 2180 to 2200	✓	✓	✓	✓	✓	✓	✓	✓
24	UL: 1625.5 to 1660.5	DL: 1525 to 1559	✓	✓	✓	✓	✓	✓	✓	✓
25	UL: 1850 to 1915	DL: 1930 to 1995	✓	✓	✓	✓	✓	✓	✓	✓
26	UL: 814 to 849	DL: 859 to 894	✓	✓	✓	✓	✓	✓	✓	✓
27	UL: 807 to 824	DL: 852 to 869	✓	✓	✓	✓	✓	✓	✓	✓
28	UL: 703 to 748	DL: 758 to 803	✓	✓	✓	✓	✓	✓	✓	✓
29	UL: -	DL: 717 to 728	✓	✓	✓	✓	✓	✓	✓	✓
30	UL: 2305 to 2315	DL: 2350 to 2360	✓	✓	✓	✓	✓	✓	✓	✓
31	UL: 452.5 to 457.5	DL: 462.5 to 467.5	✗	✗	✗	✗	✗	✗	✗	✗
32	UL: -	DL: 1452 - 1496	✓	✓	✗	✓	✓	✗	✓	✓
35		1850 to 1910	✓	✓	✓	✓	✓	✓	✓	✓
38		2570 to 2620	✓	✓	✓	✓	✓	✓	✓	✓
39		1880 to 1920	✓	✓	✓	✓	✓	✓	✓	✓
40		2300 to 2400	✓	✓	✓	✓	✓	✓	✓	✓
41		2496 to 2690	✓	✓	✓	✓	✓	✓	✓	✓
42		3400 to 3600	✗	✓	✗	✗	✗	✗	✓	✗
43		3600 to 3800	✗	✓	✗	✗	✗	✗	✓	✗
48		3550 to 3700	✗	✓	✗	✗	✗	✗	✓	✗
66	UL: 1710-1780	DL: 2110-2200	✓	✓	✓	✓	✓	✓	✓	✓
71		617 to 698	✓	✗	✓	✓	✓	✓	✗	✓
74/75/76		1427 to 1518	✓	✓	✗	✓	✓	✗	✓	✓
77		3300 to 4200	✗	✓	✗	✗	✗	✗	✓	✗
78		3300 to 3800	✗	✓	✗	✗	✗	✗	✓	✗
79		4400 to 5000	✓	✗	✓	✗	✓	✓	✗	✓

*Covered bands represented as 20% efficiency, tested at 1m cable.

3. Active Antenna Characteristics

3.1 Block Diagram (Active antenna)

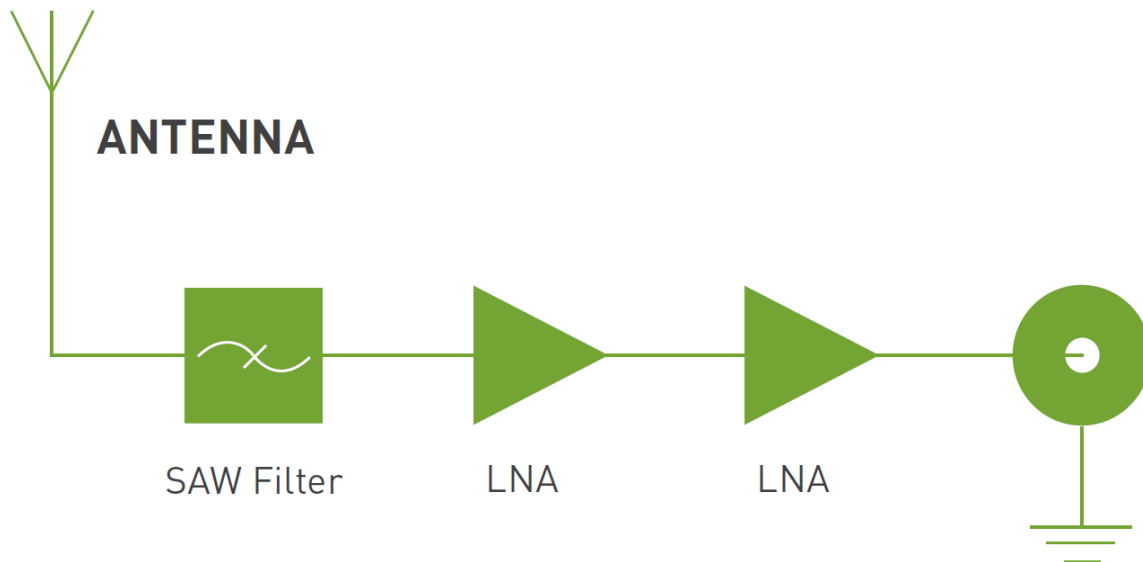

3.2 Passive Antenna Return Loss

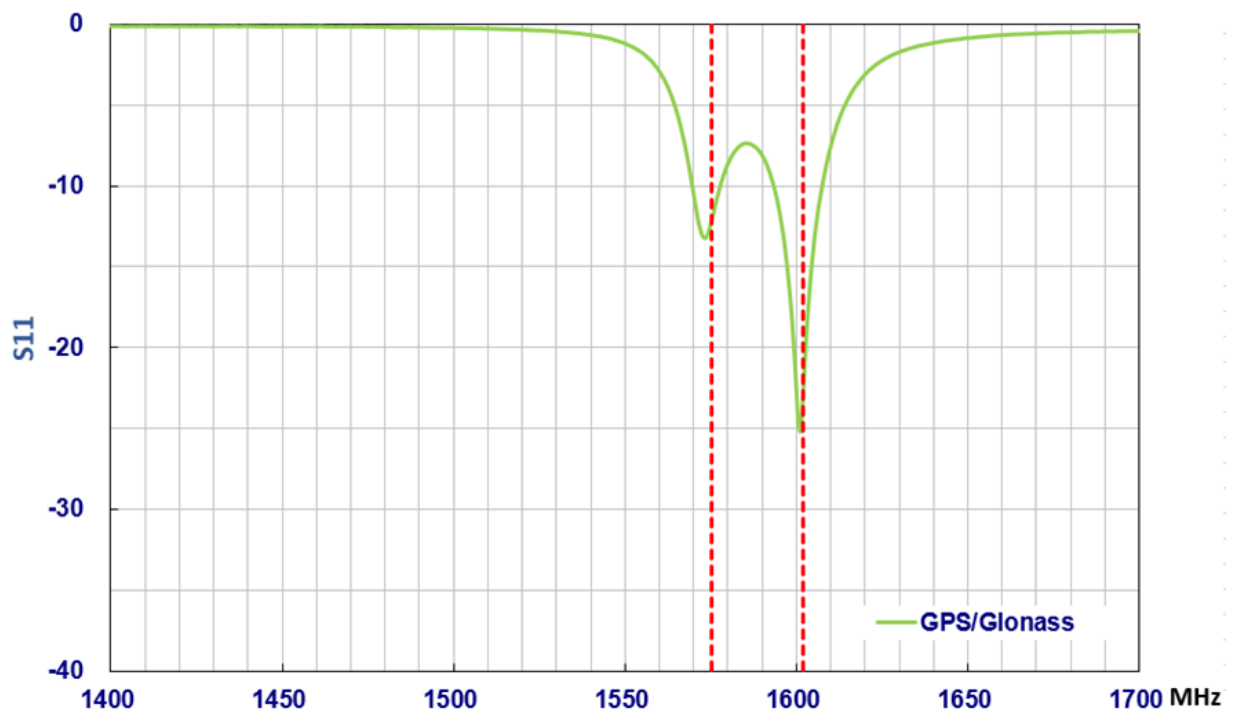

3.3 Passive Antenna Efficiency

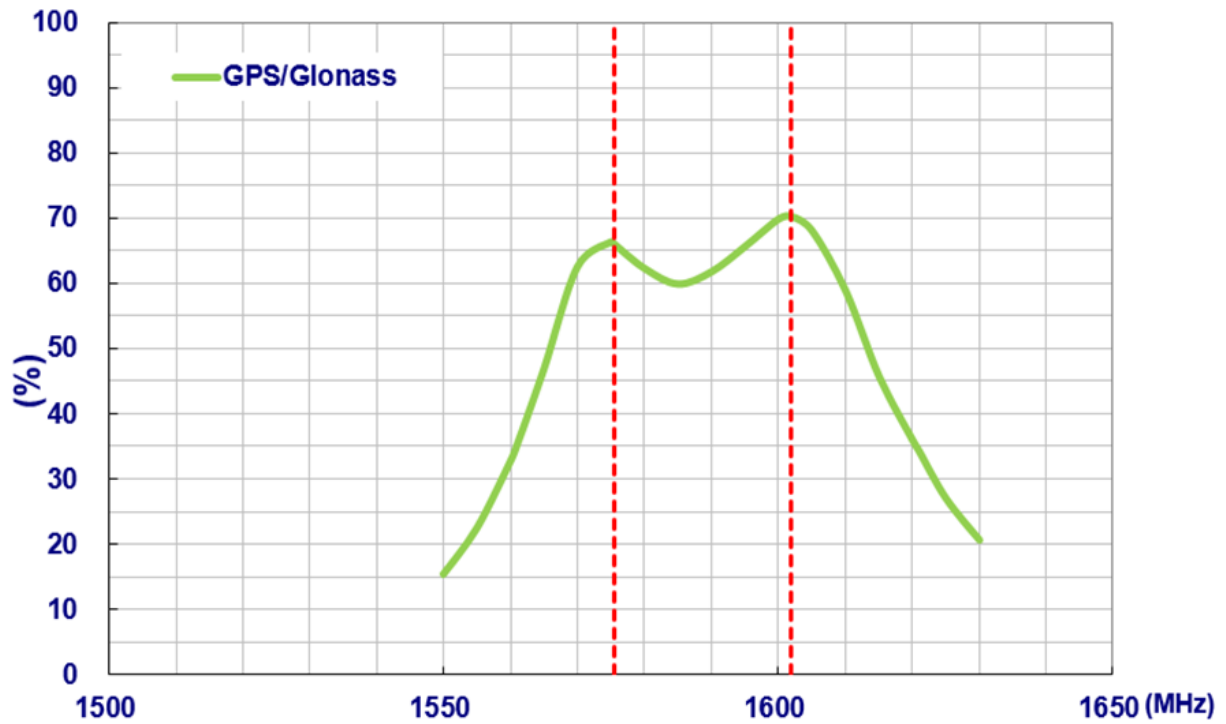

3.4 Passive Antenna Average Gain

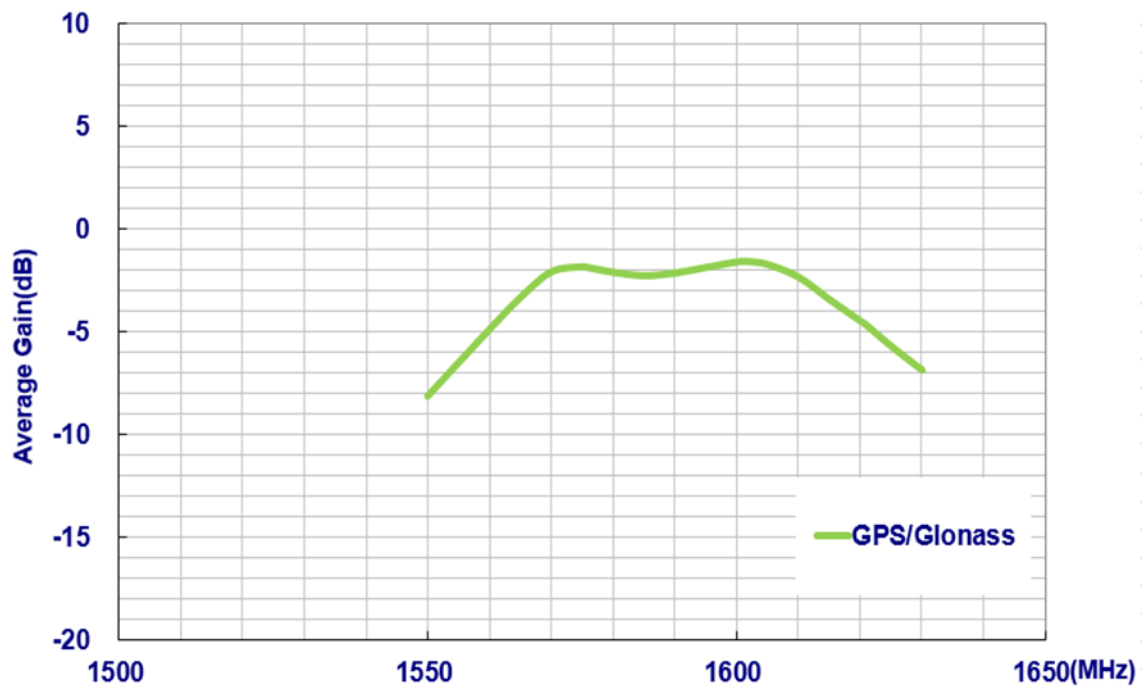

3.5 Passive Antenna Peak Gain

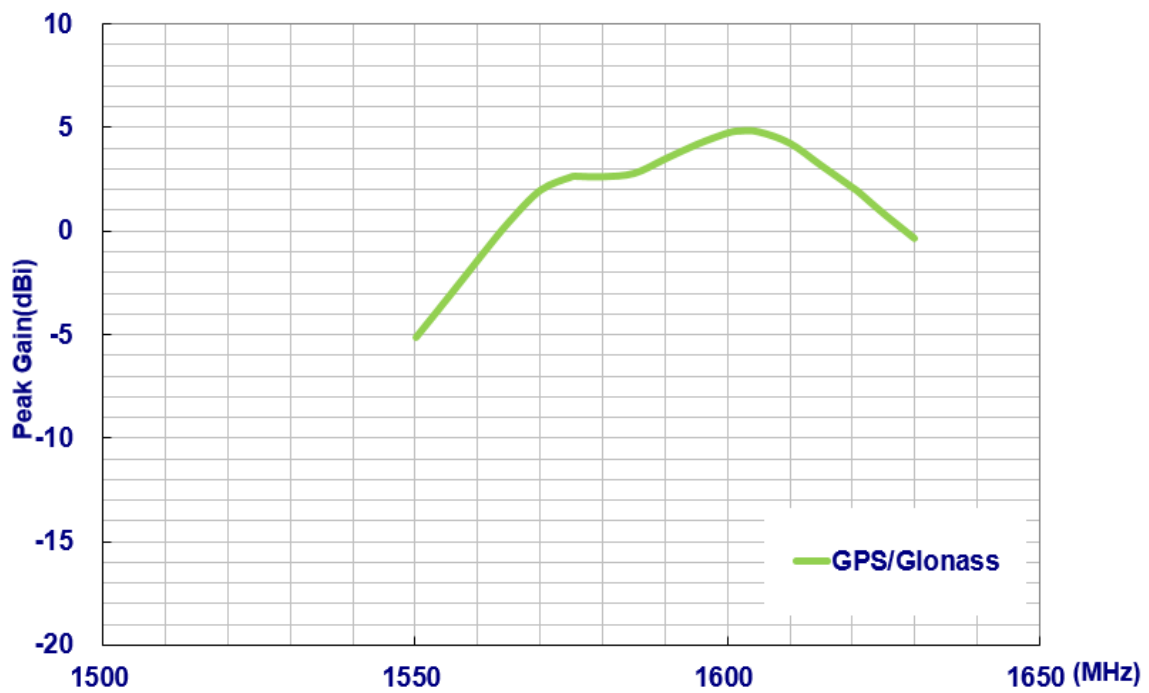

3.6 Passive Antenna Axial Ratio (Zenith is at 0°)

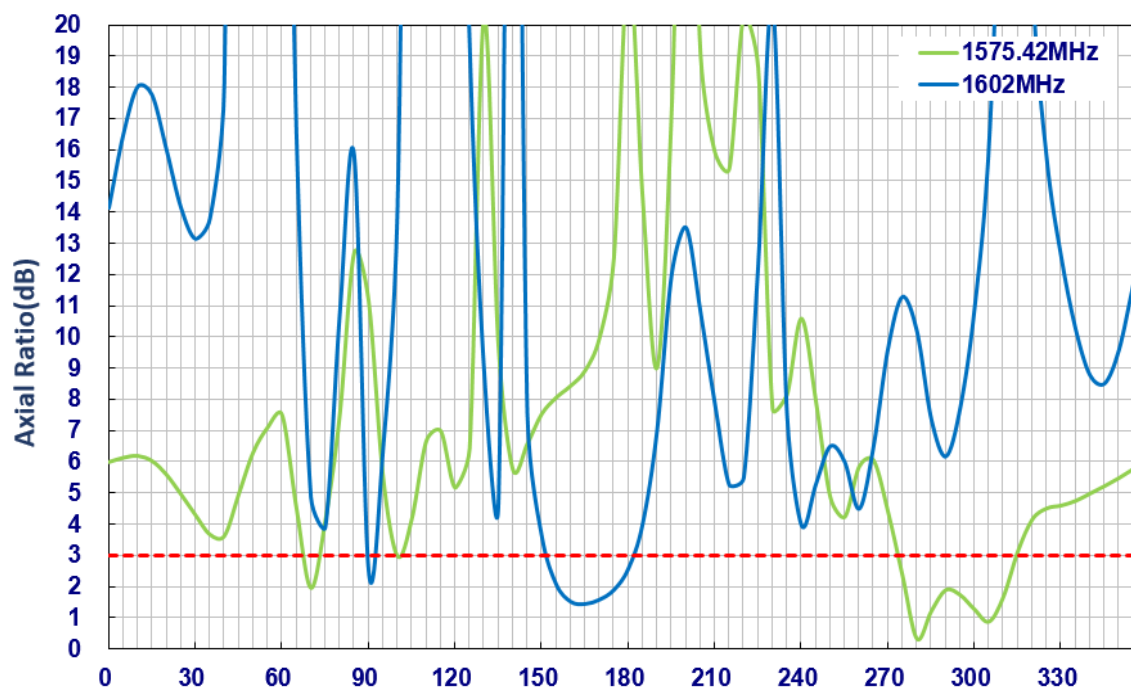

3.7 Active measurements

LNA Gain @ 3.0V

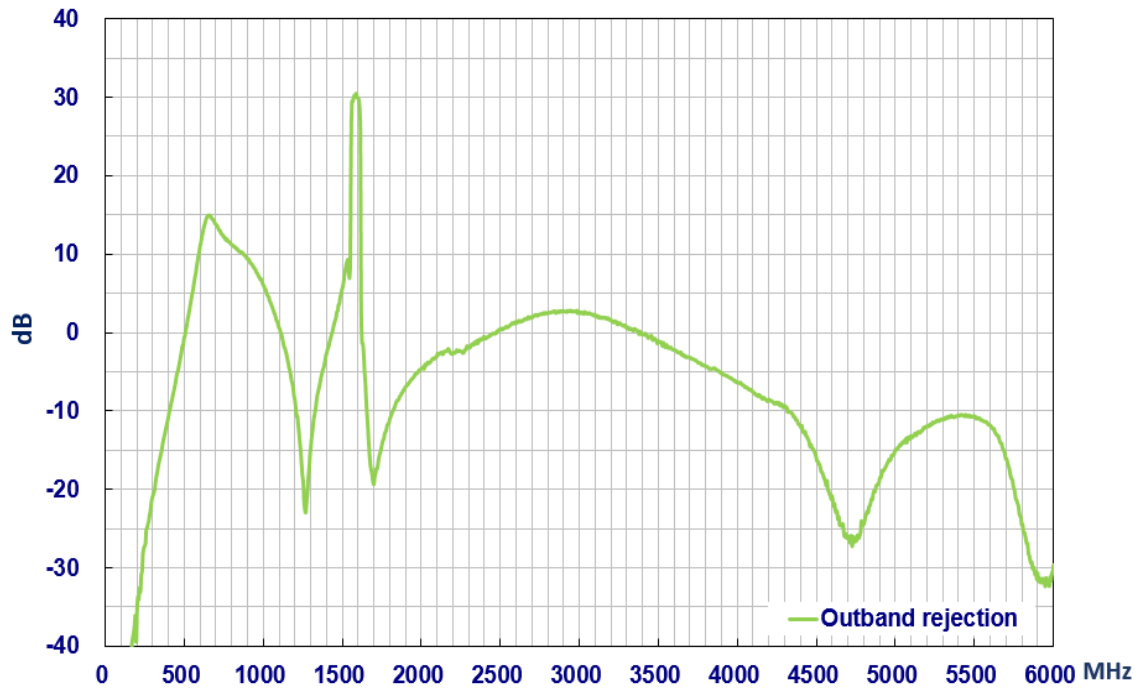

Noise Figure @ 3.0V

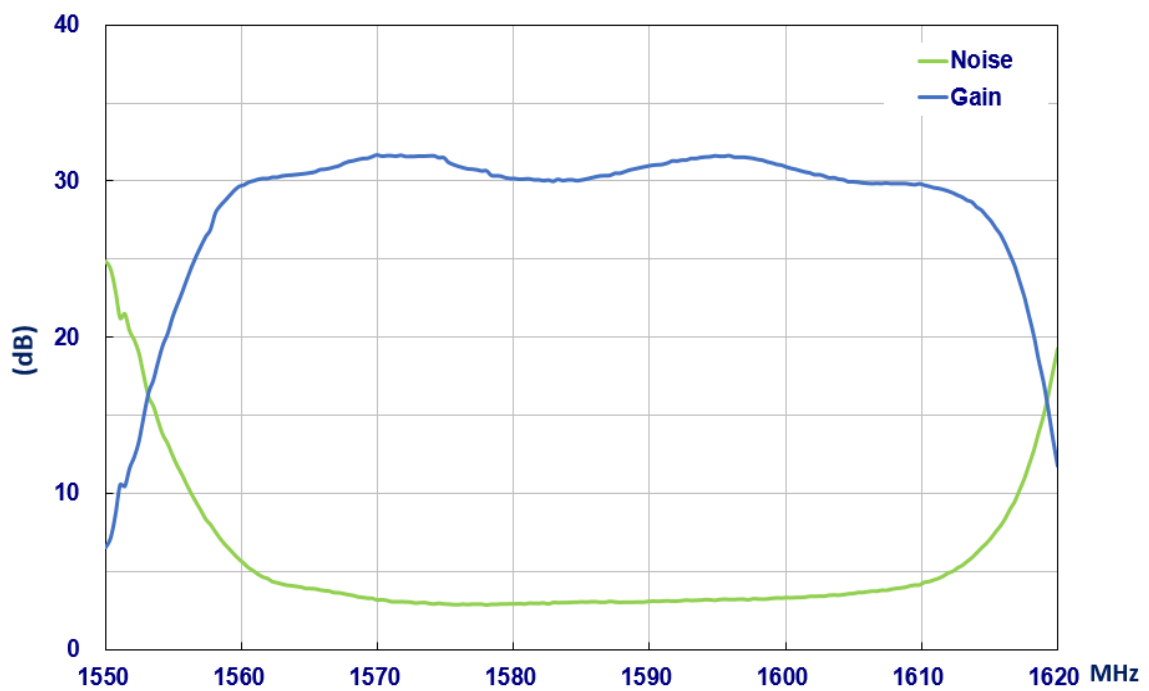

3.8 GNSS Radiation Pattern

1575.42MHz

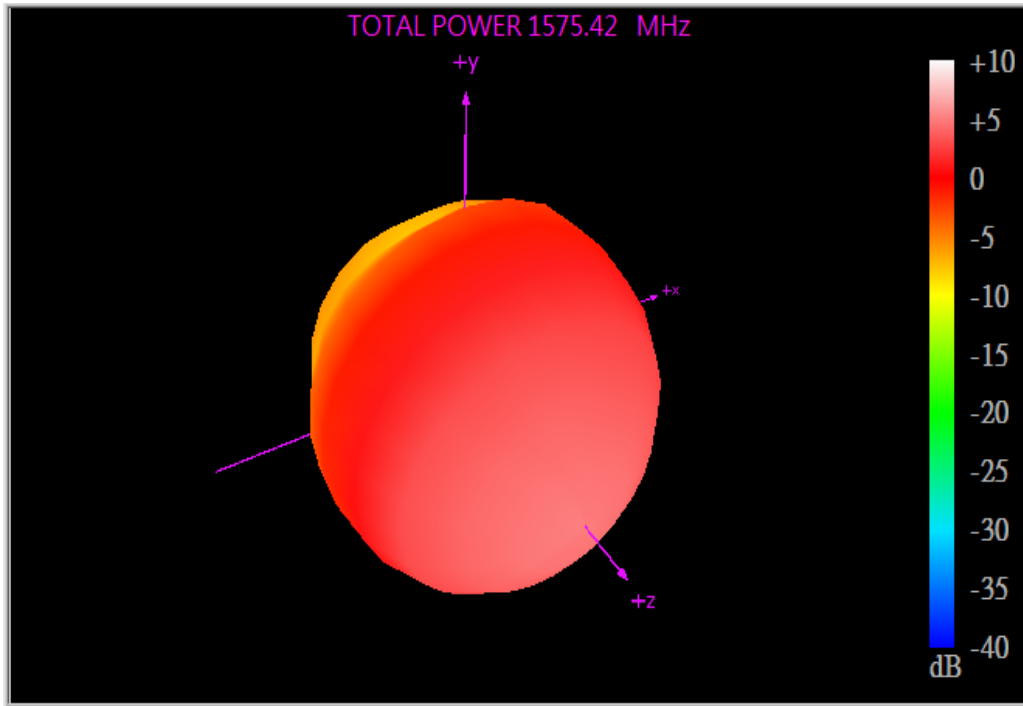

XY Plane

XZ Plane

YZ Plane

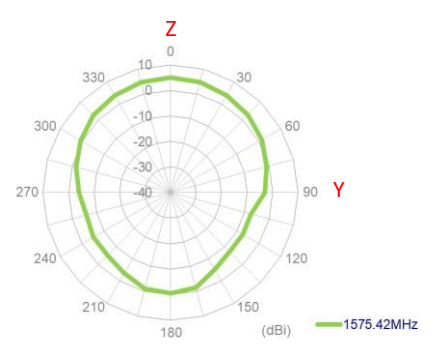
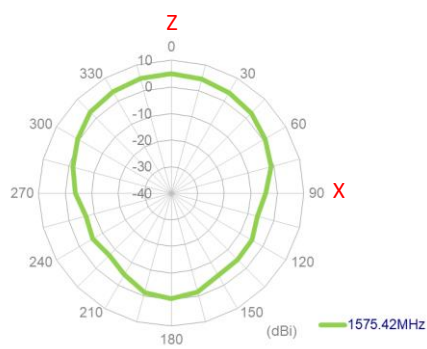
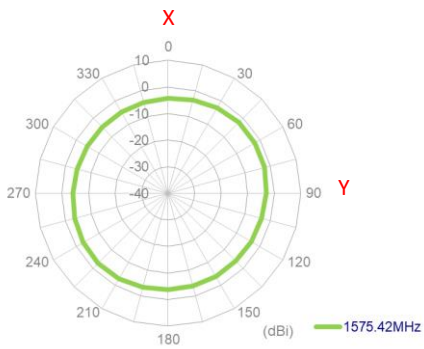

1602MHz

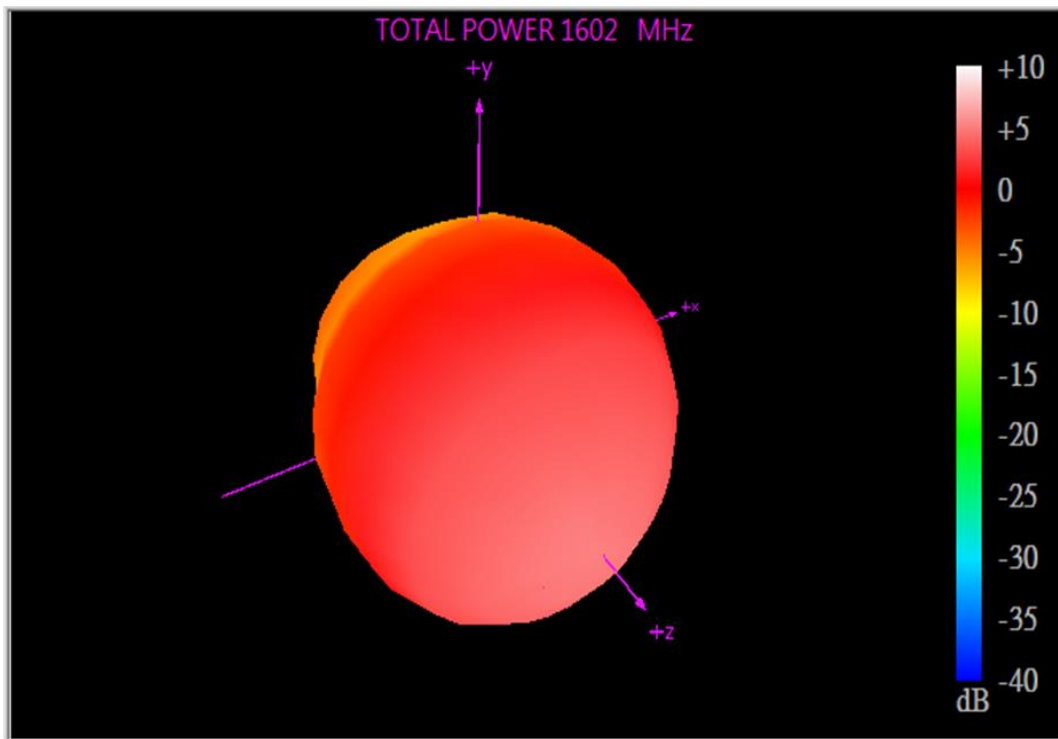

XY Plane

XZ Plane

YZ Plane

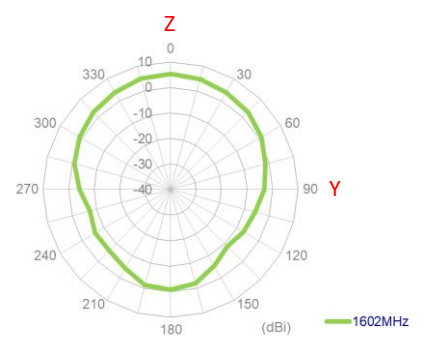
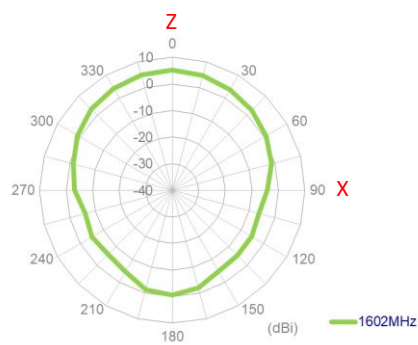
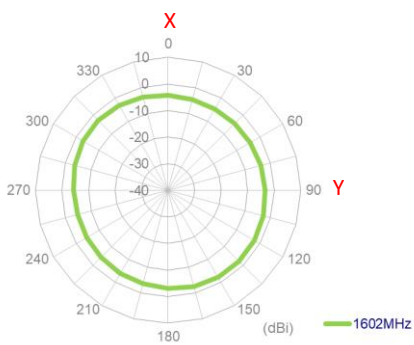

4. Antenna Characteristics

4.1 Return Loss

Cellular MIMO

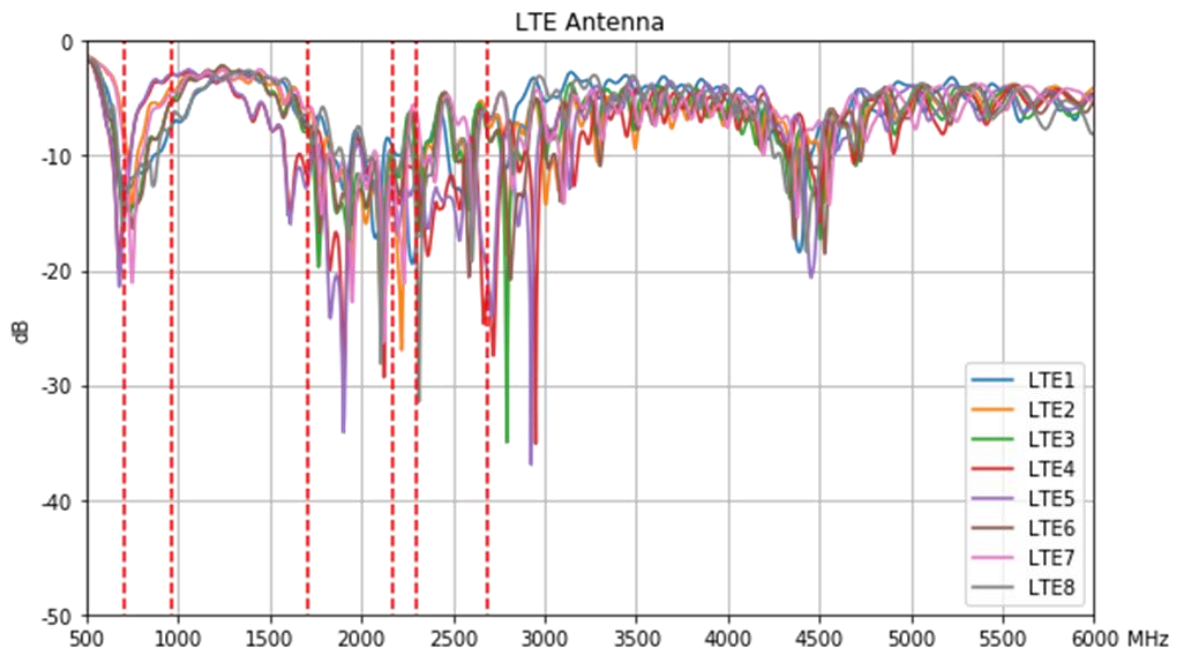

4.2 Isolation

Cellular 1

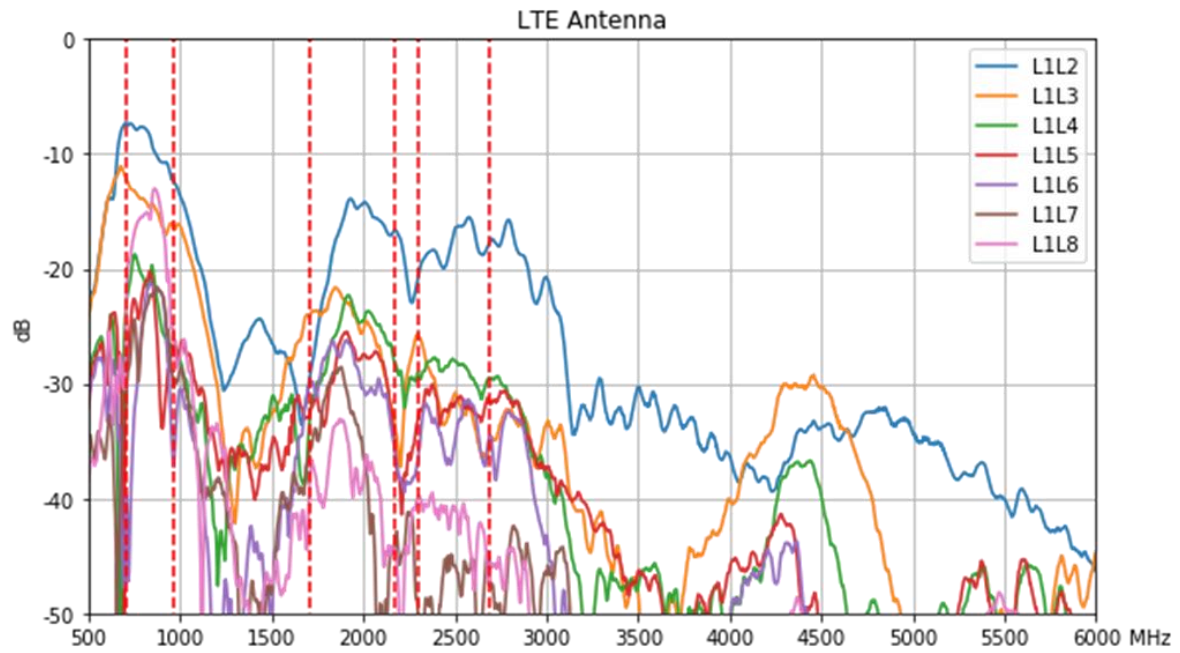

Cellular 2

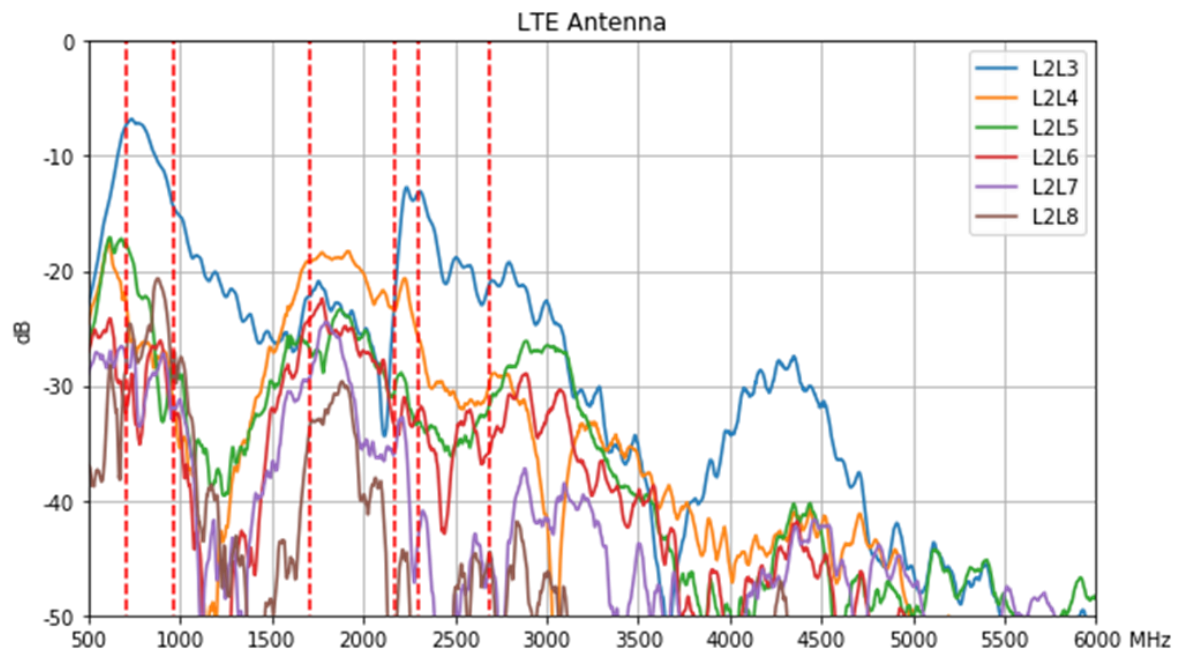

Cellular 3 and Cellular 4

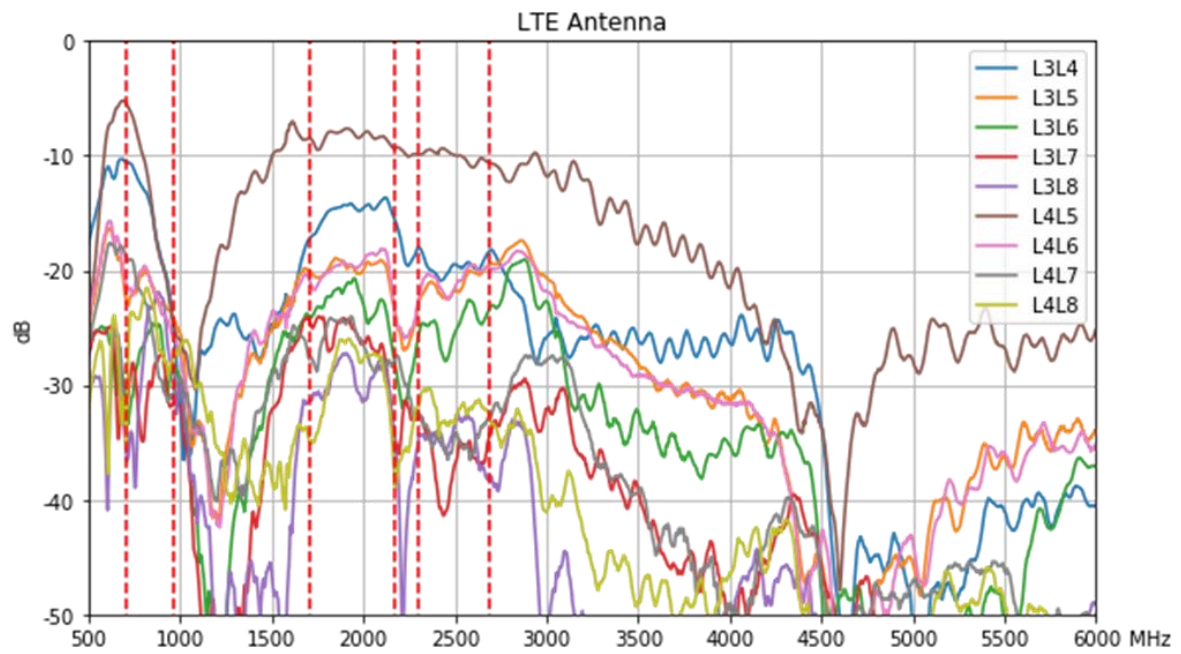

Cellular 5、Cellular 6 and Cellular 7

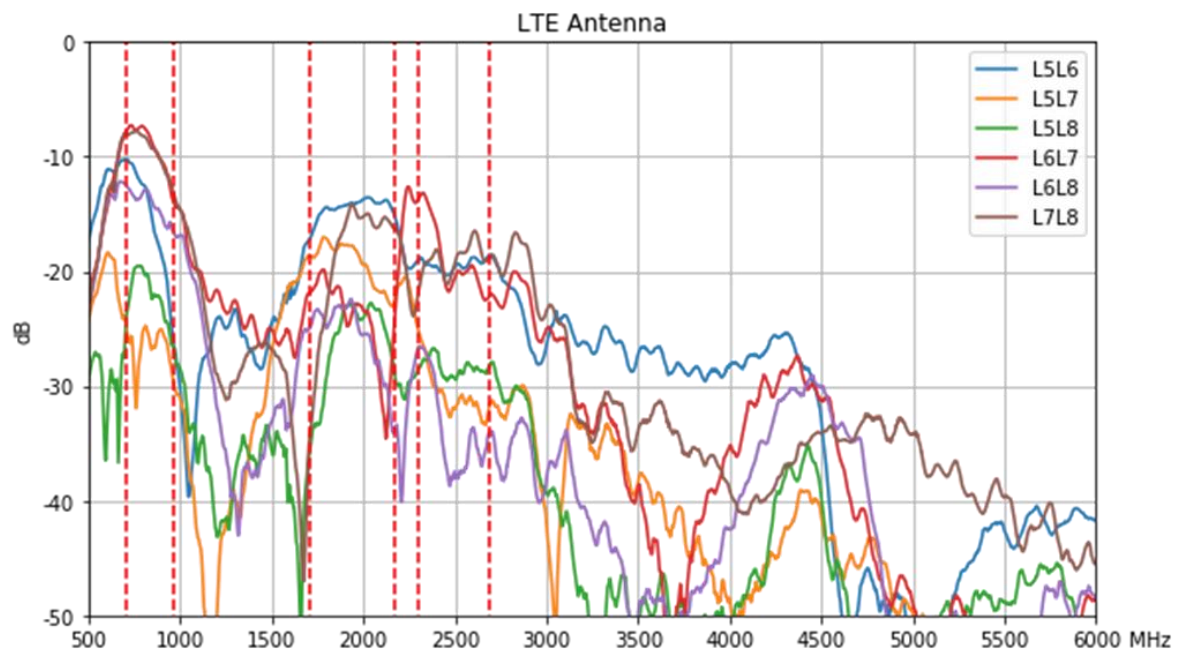

4.3 Efficiency

Cellular MIMO

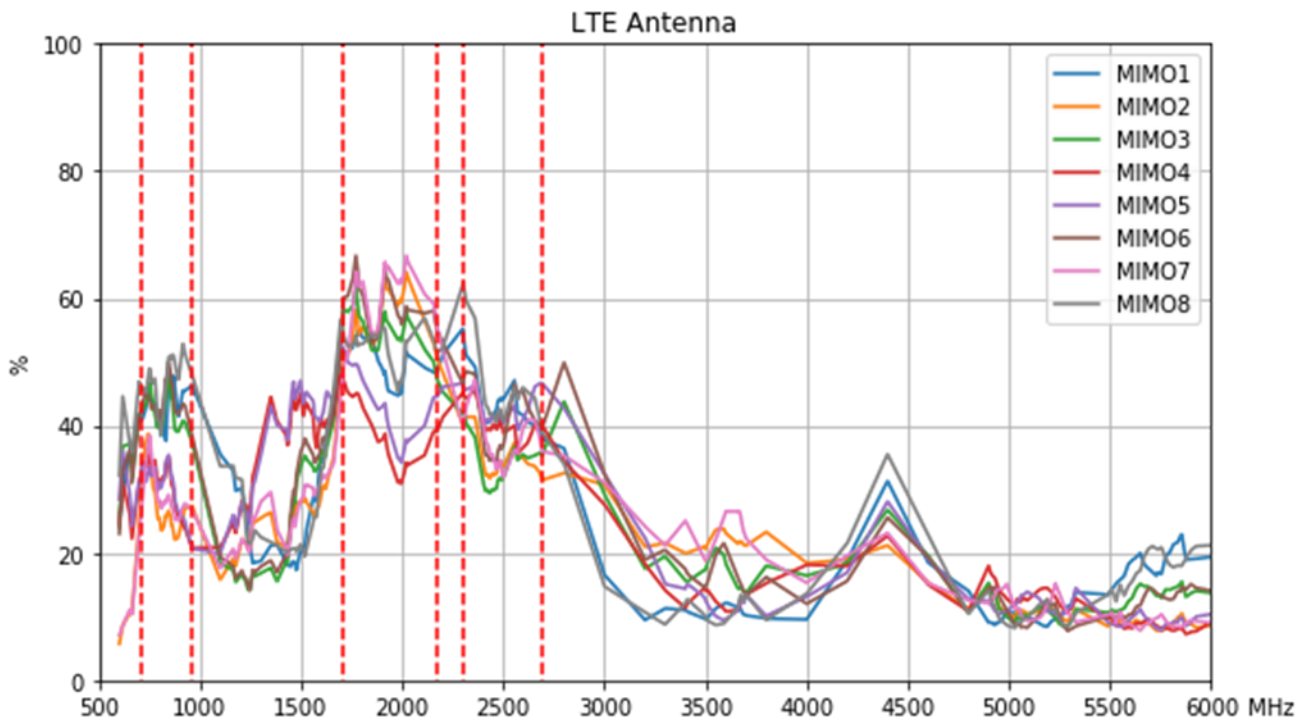

4.4 Average Gain

Cellular MIMO

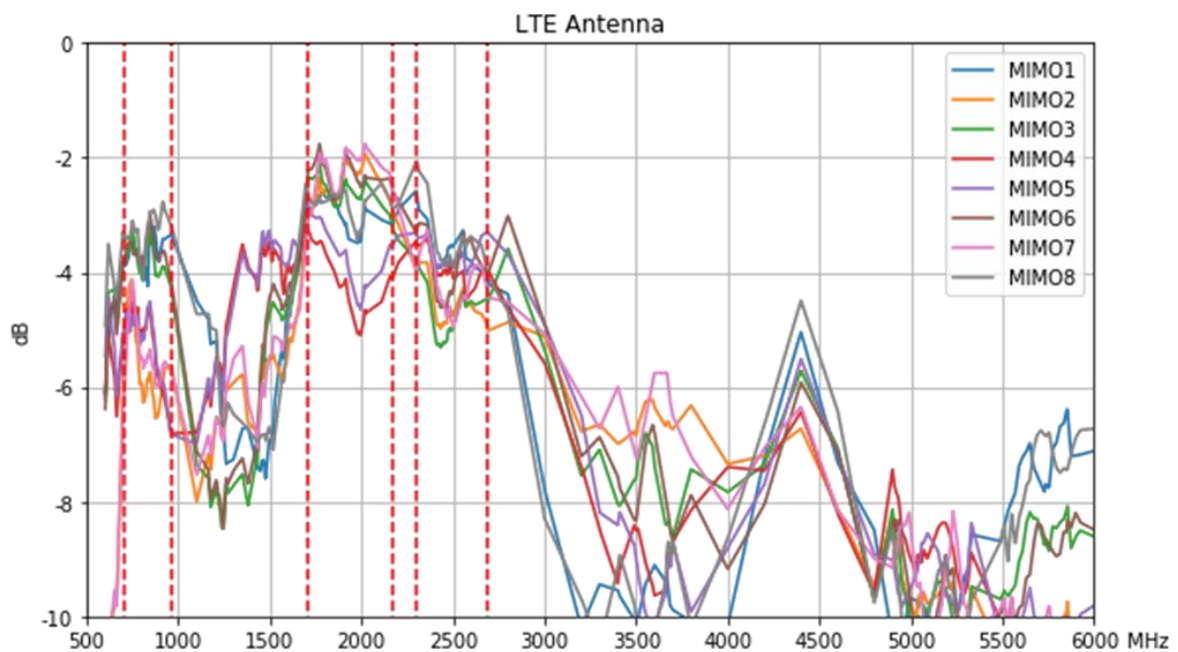

4.5 Peak Gain

Cellular MIMO

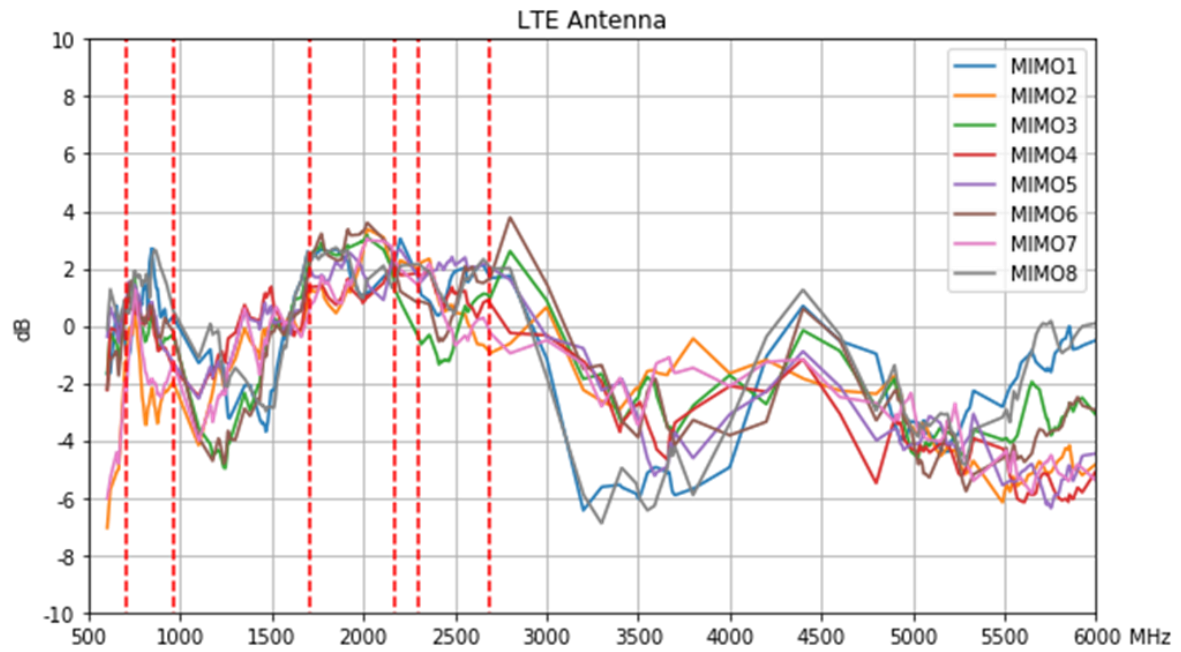

5. Radiation Patterns

5.1 Test Setup

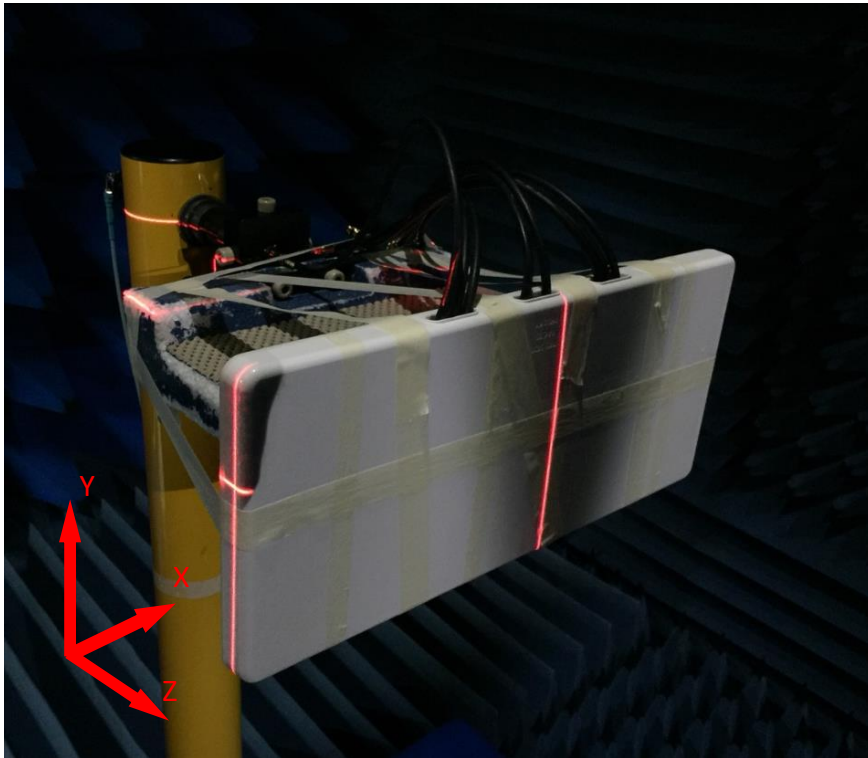

Free space

5.2 Cellular MIMO1 Radiation Pattern

751MHz

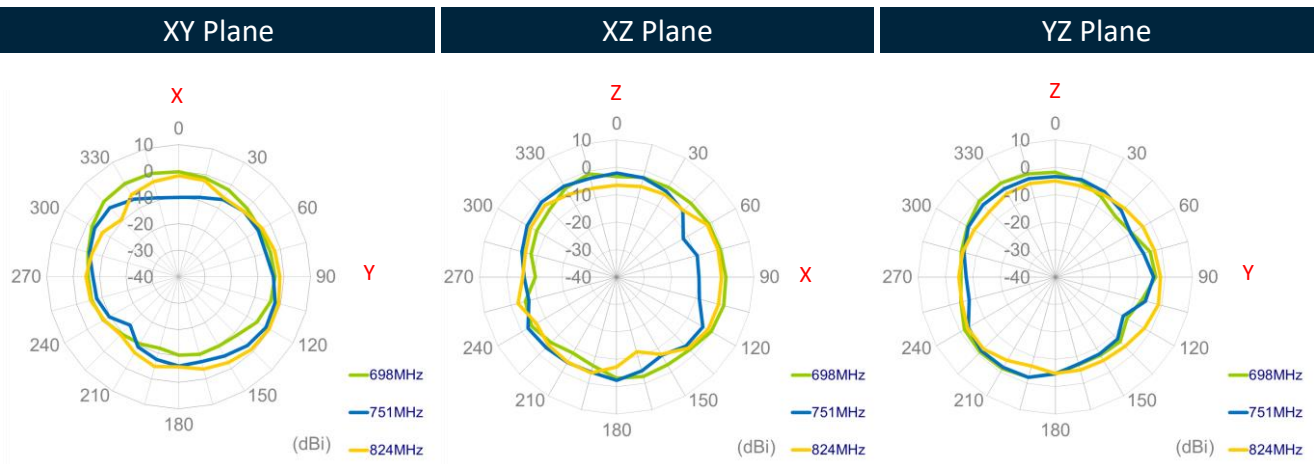
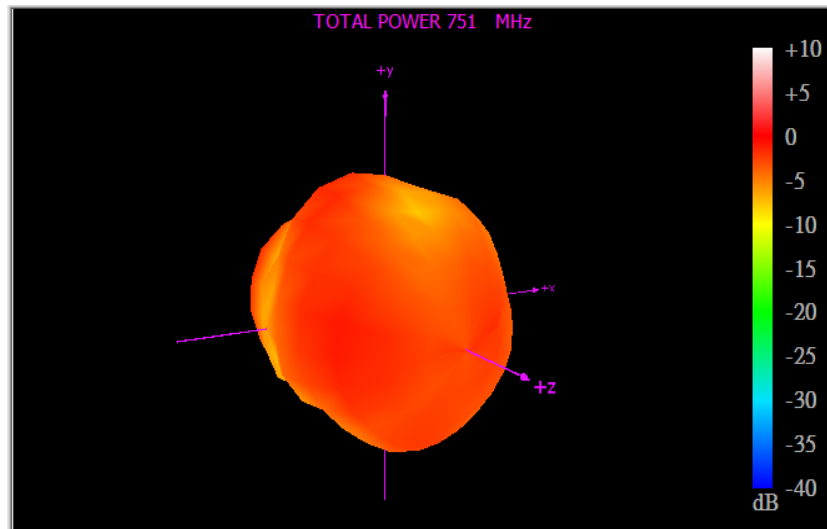

880MHz

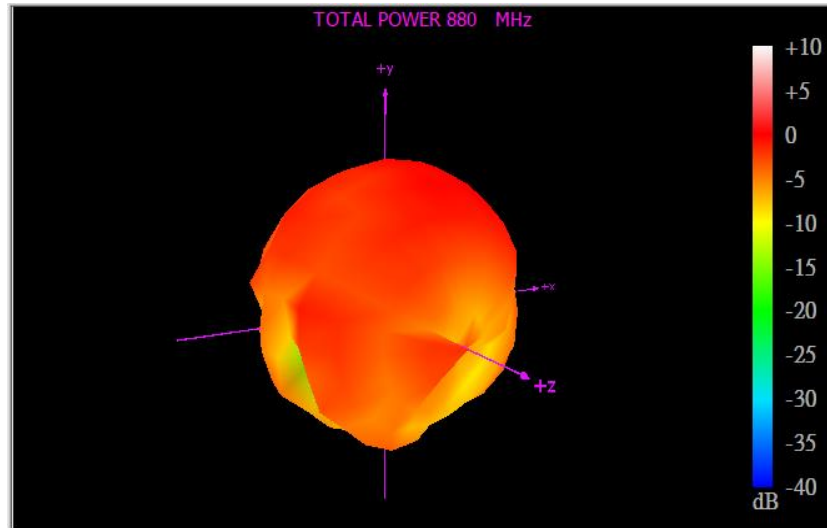

XY Plane XZ Plane YZ Plane

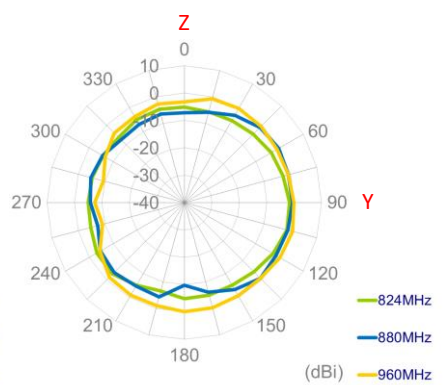
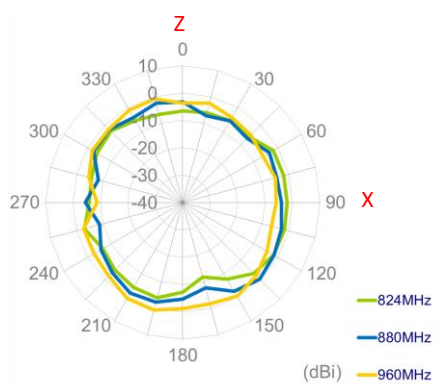
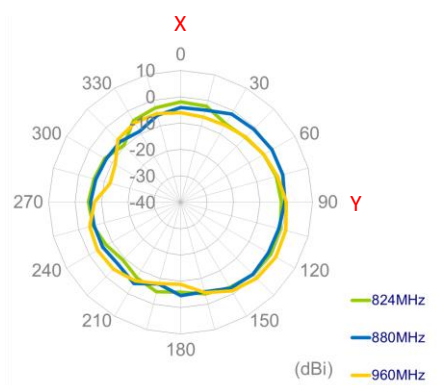

1805MHz

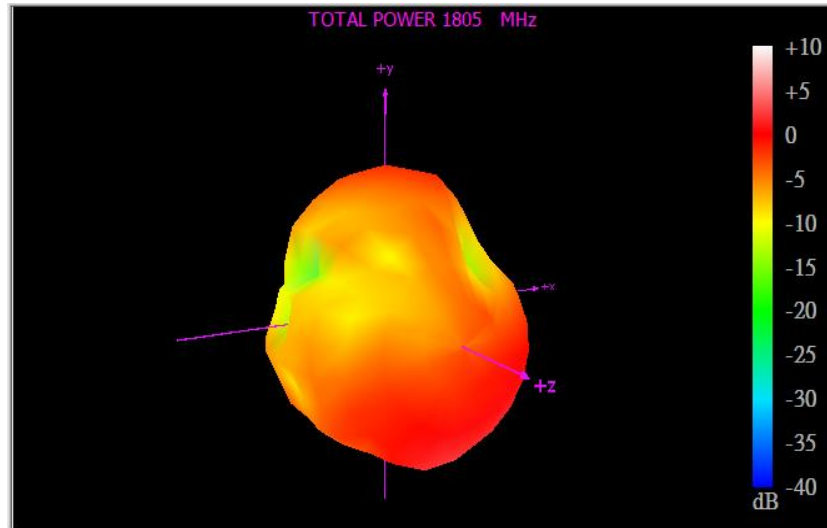

XY Plane XZ Plane YZ Plane

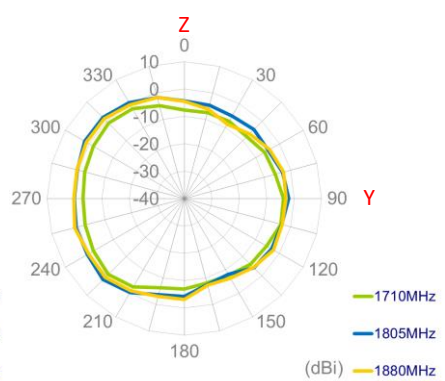
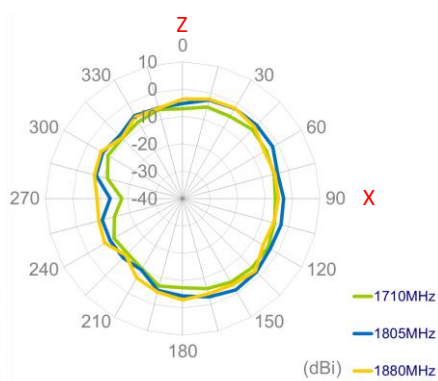
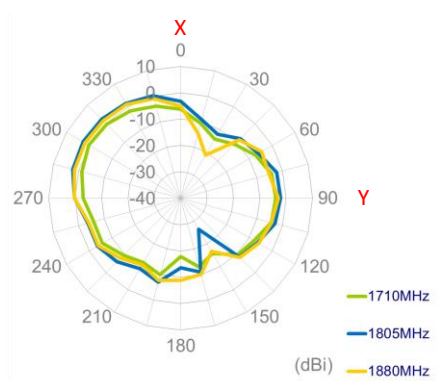

1920MHz

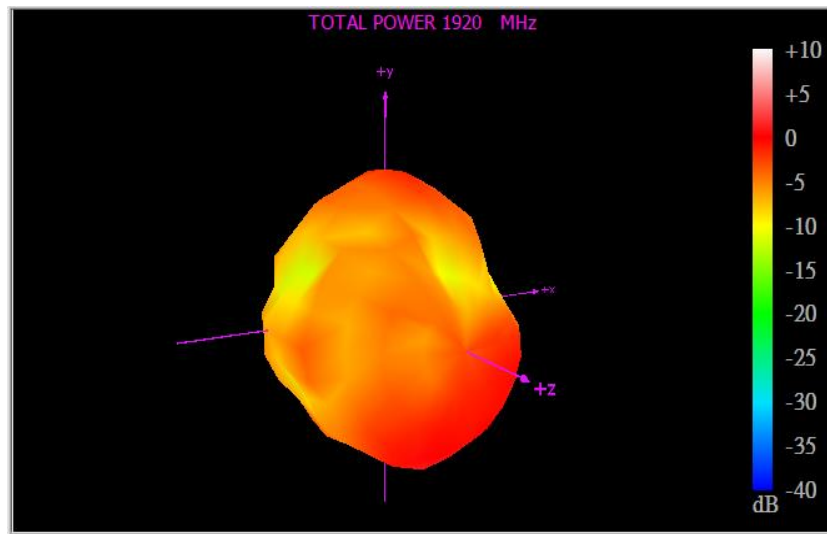

XY Plane

XZ Plane

YZ Plane

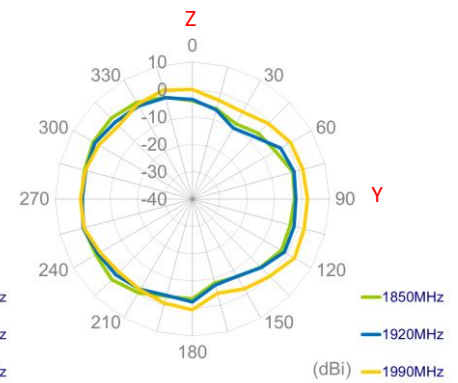
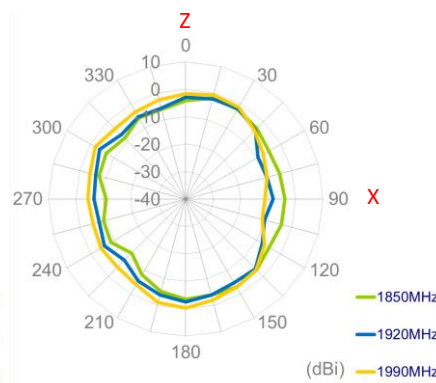
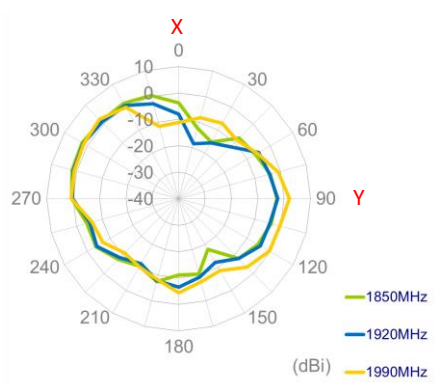

1990MHz

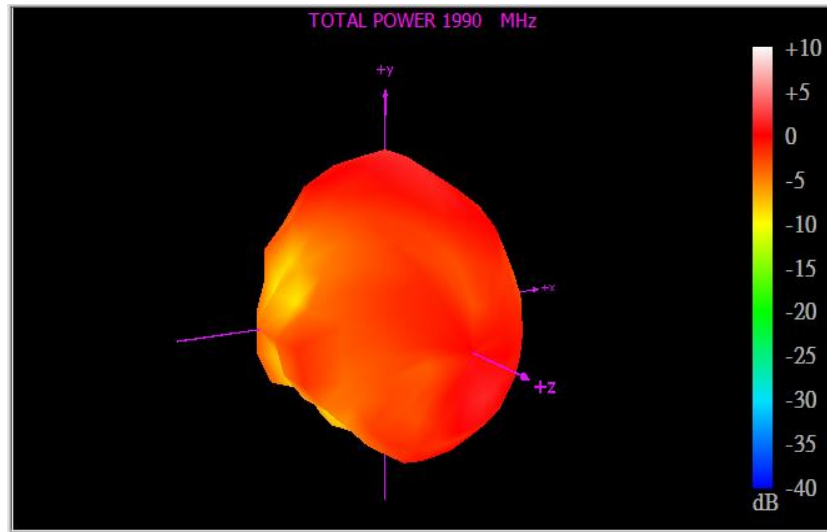

XY Plane

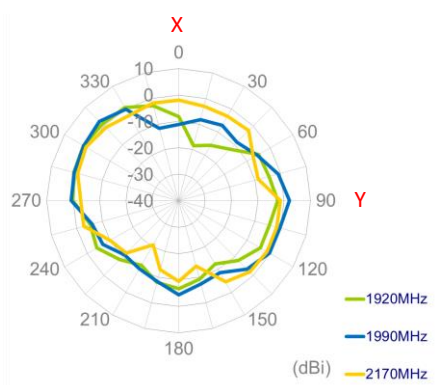

XZ Plane

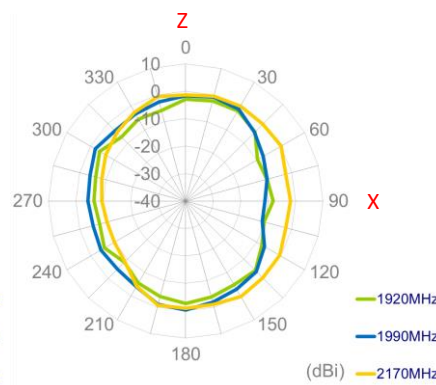

YZ Plane

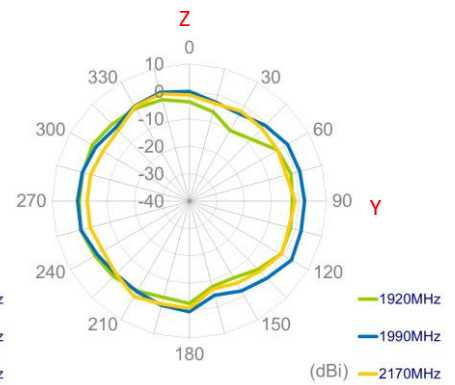

2500MHz

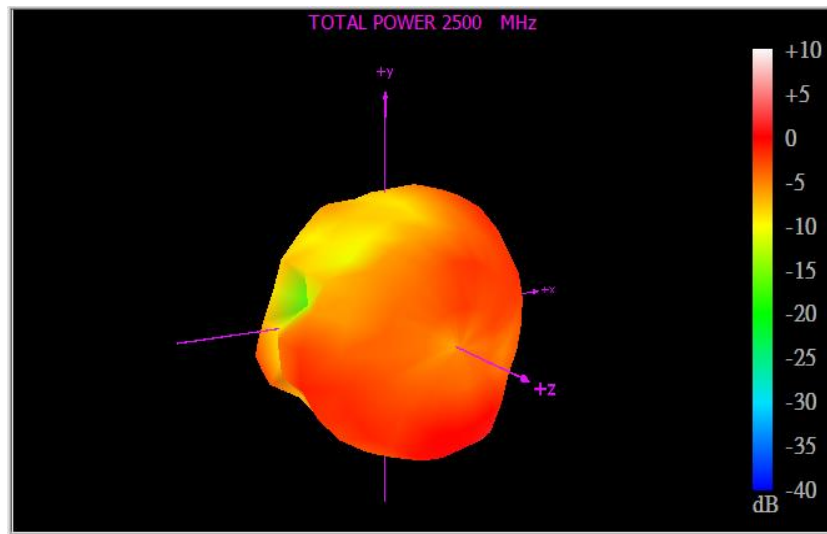

XY Plane

XZ Plane

YZ Plane

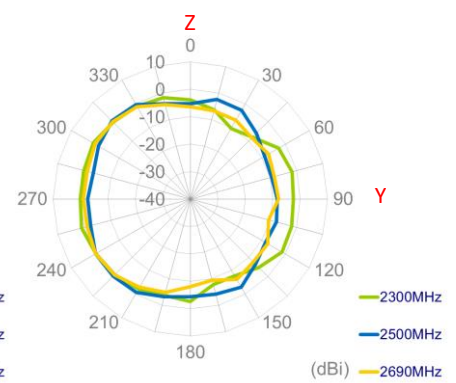
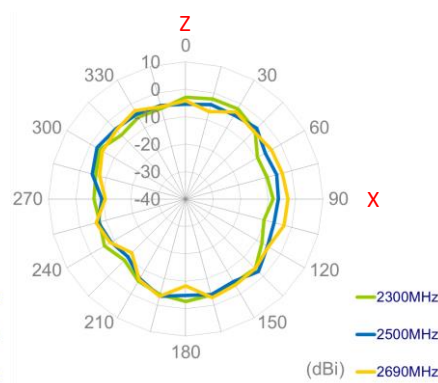
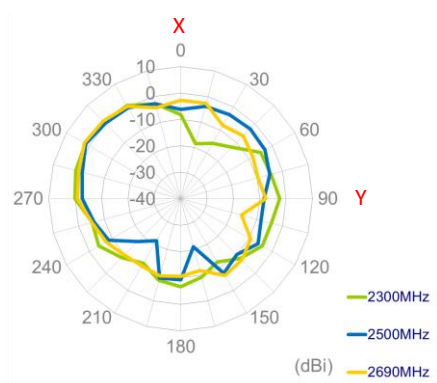

5.3 Cellular MIMO2 Radiation Pattern

751MHz

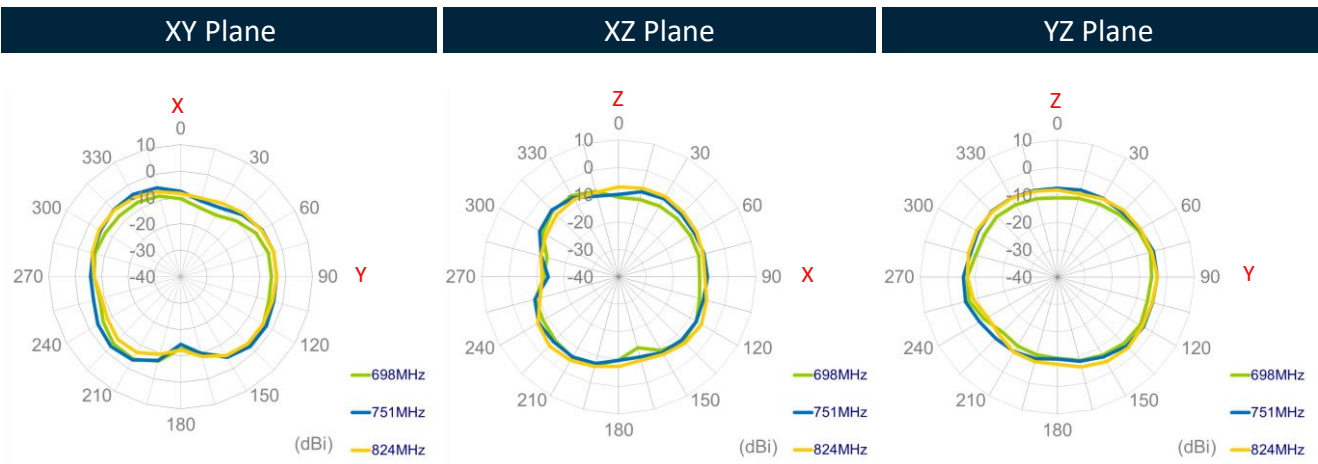
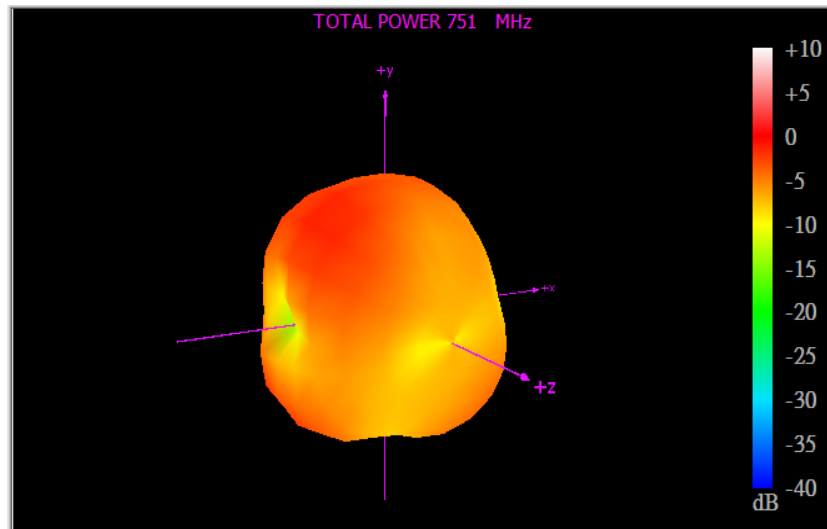

880MHz

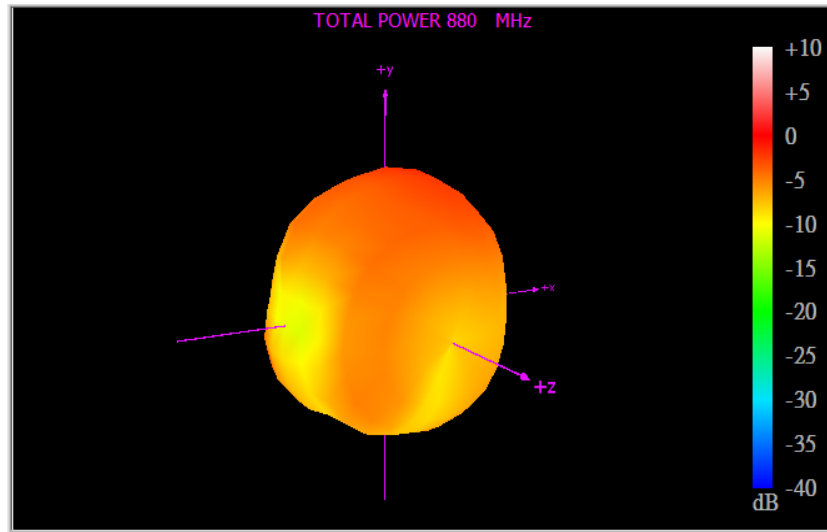

XY Plane

XZ Plane

YZ Plane

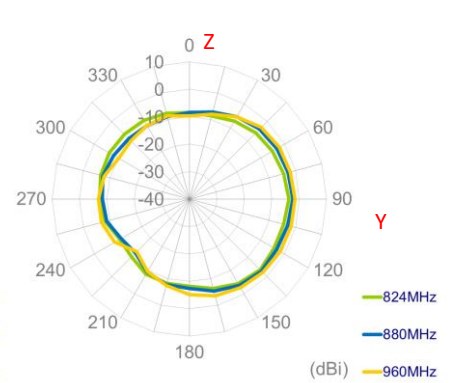
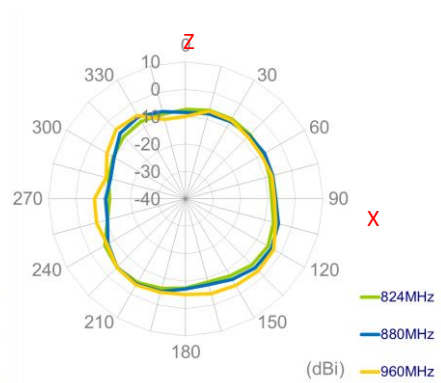
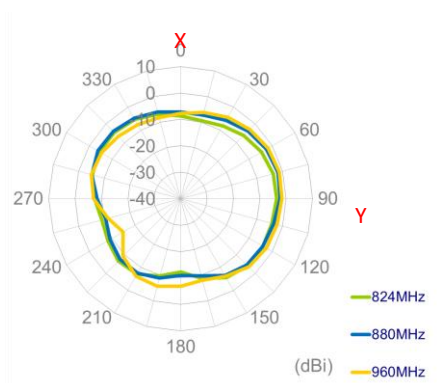

1805MHz

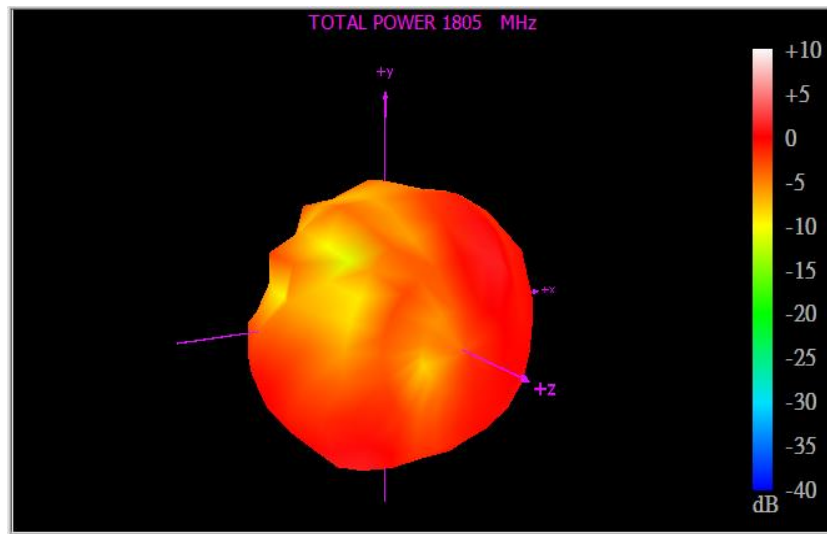

XY Plane

XZ Plane

YZ Plane

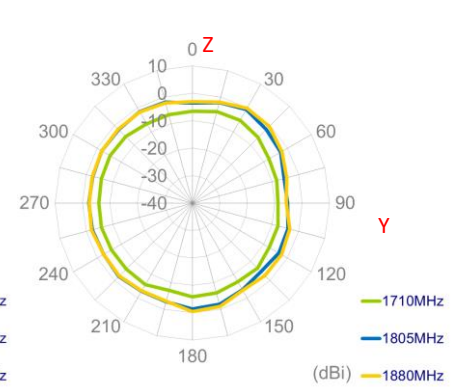
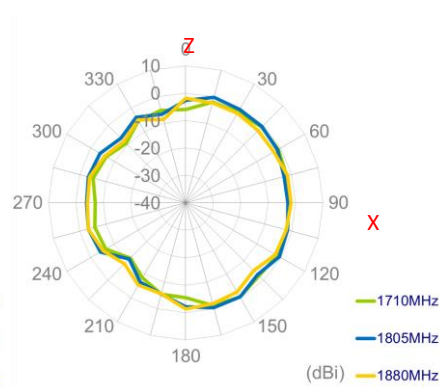
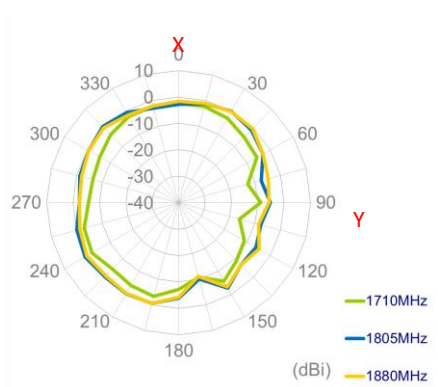

1920MHz

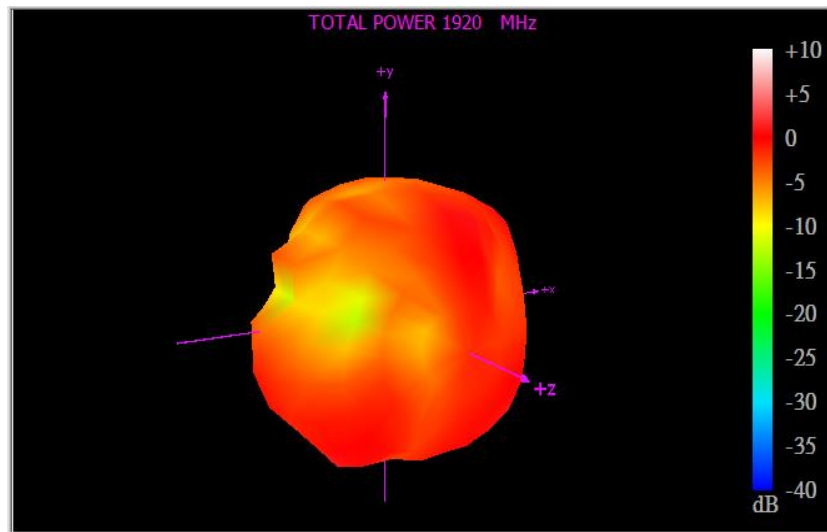

XY Plane

XZ Plane

YZ Plane

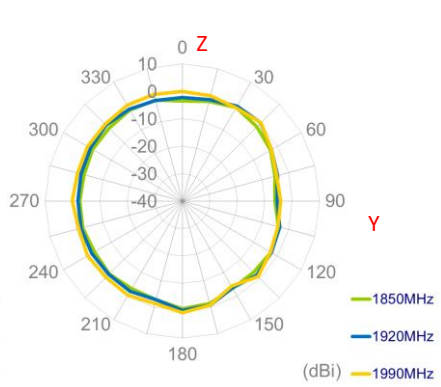
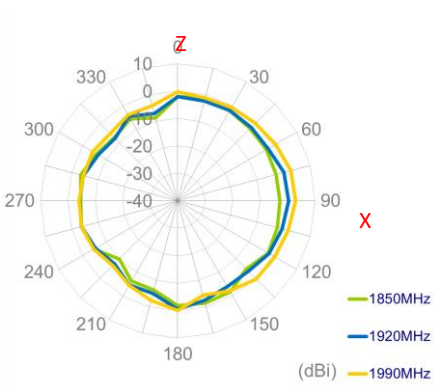
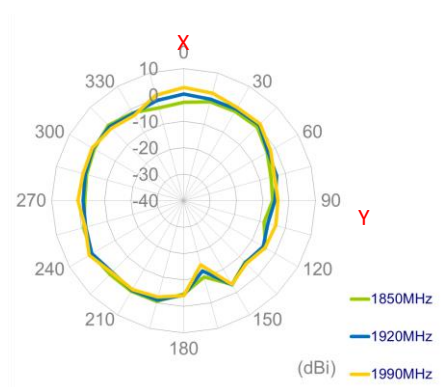

1990MHz

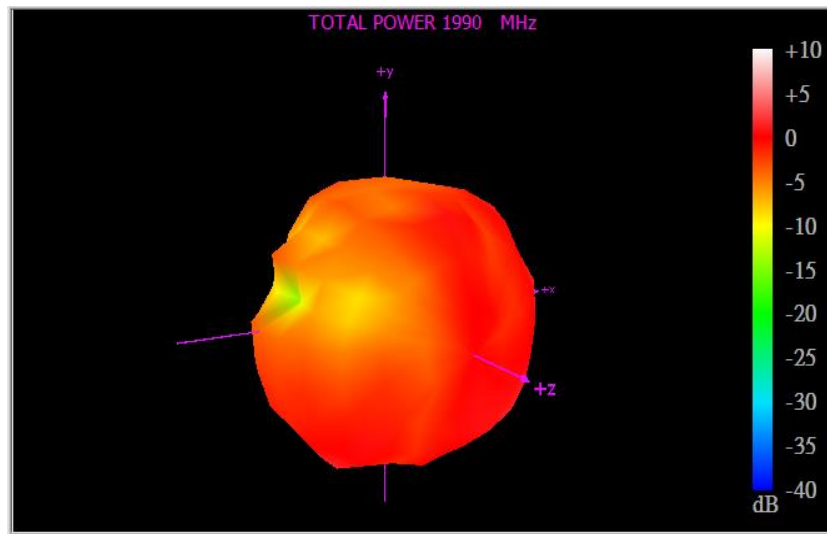

XY Plane

XZ Plane

YZ Plane

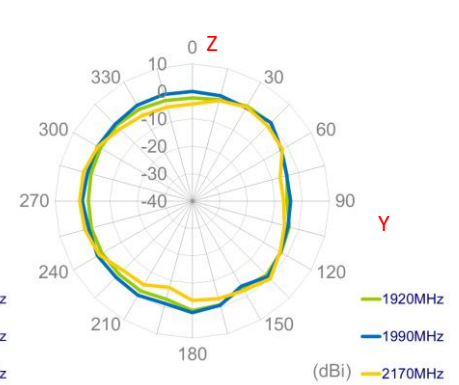
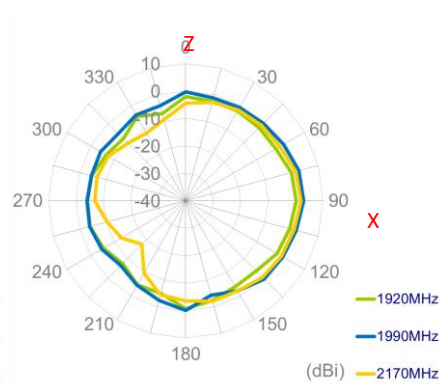
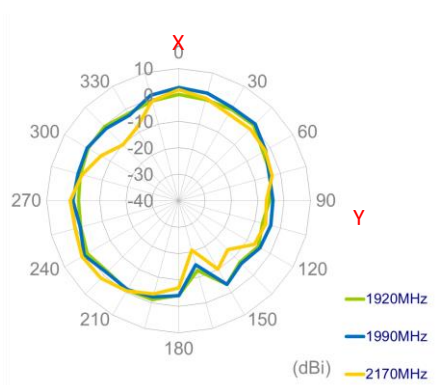

2500MHz

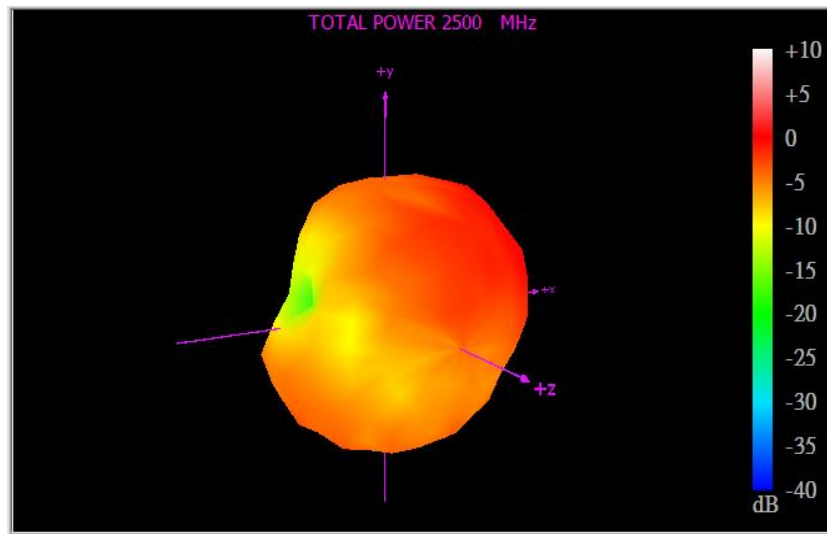

XY Plane

XZ Plane

YZ Plane

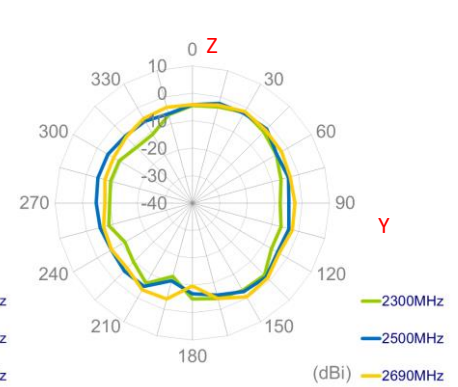
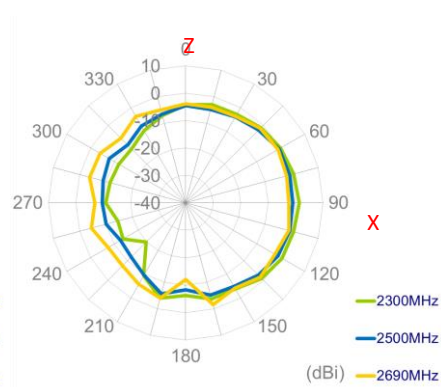
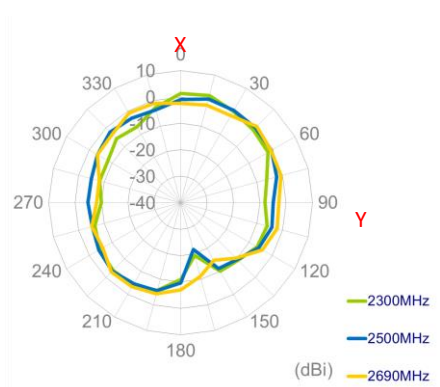

5.4 Cellular MIMO3 Radiation Pattern

751MHz

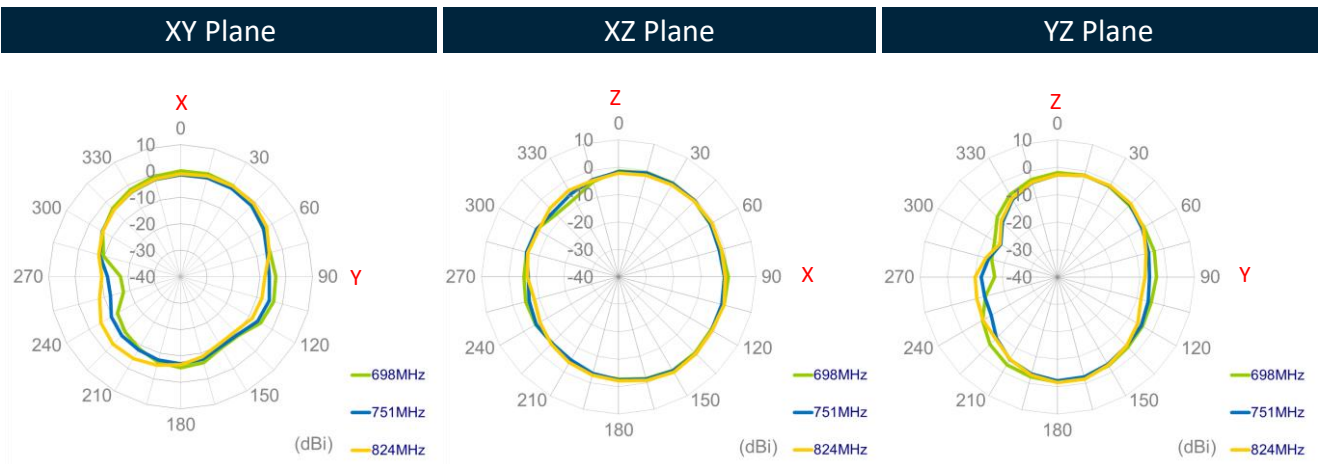
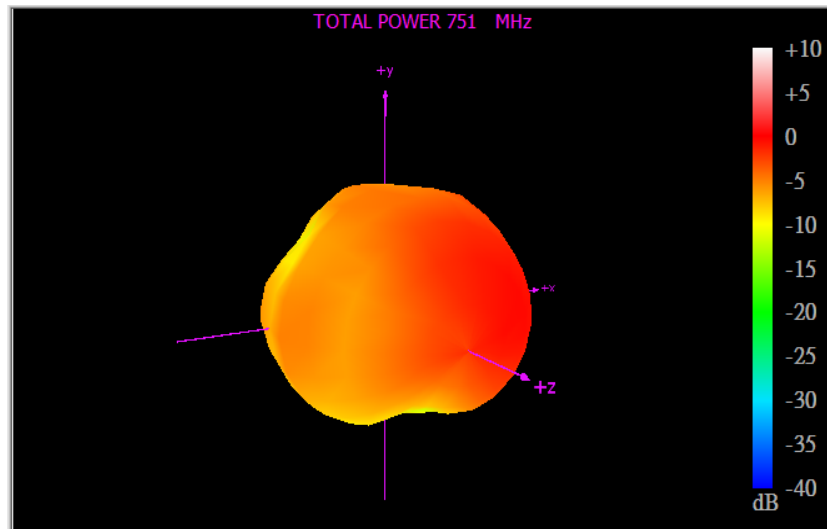

880MHz

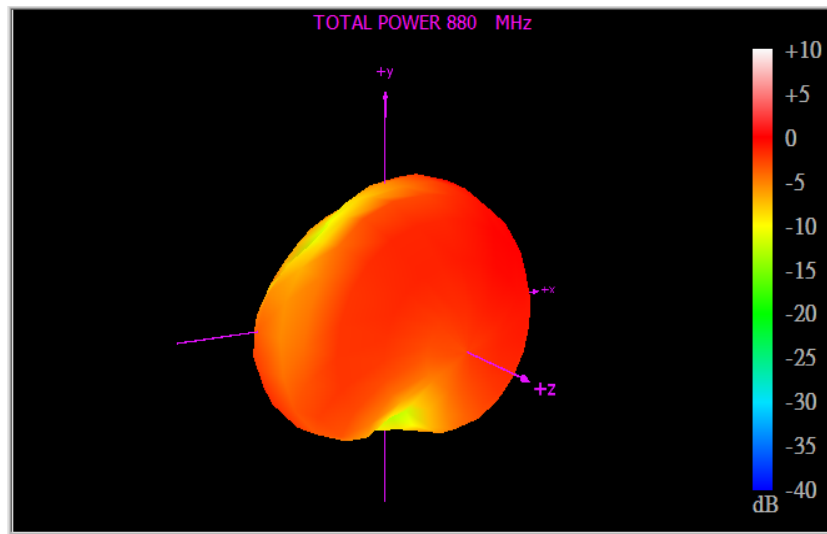

XY Plane XZ Plane YZ Plane

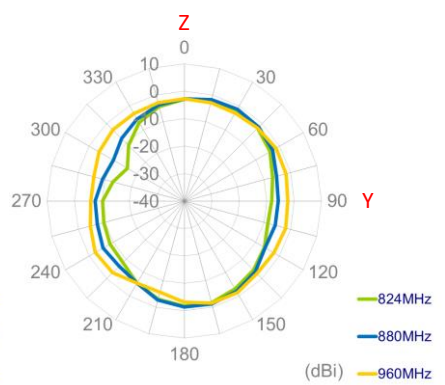
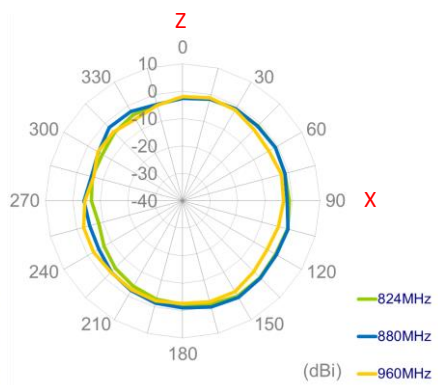
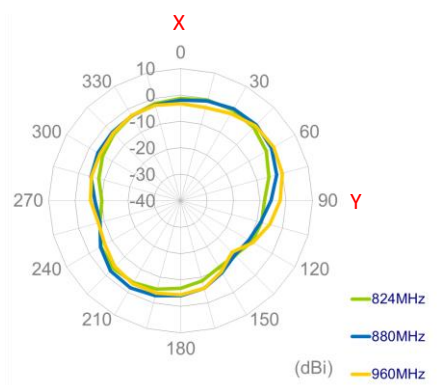

1805MHz

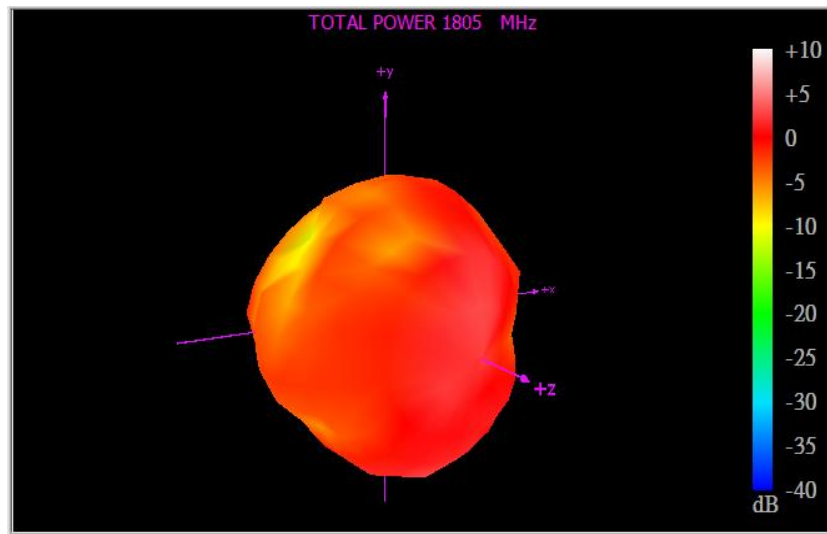

XY Plane

XZ Plane

YZ Plane

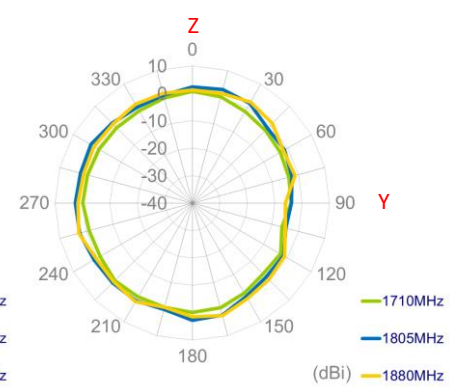
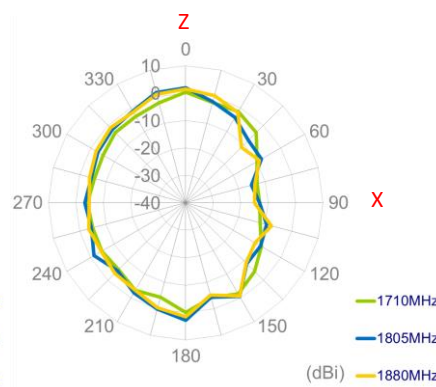
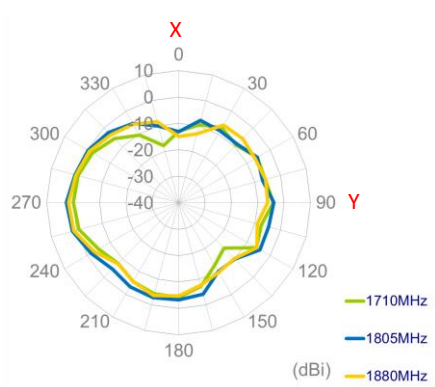

1920MHz

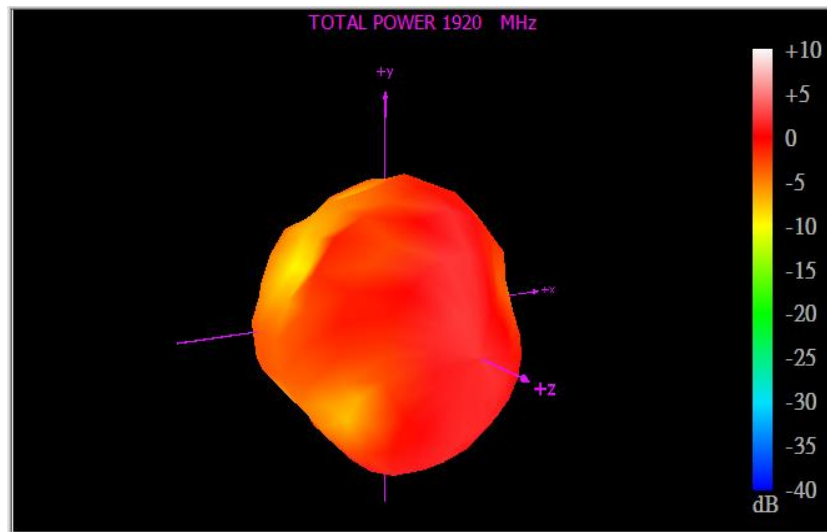

XY Plane

XZ Plane

YZ Plane

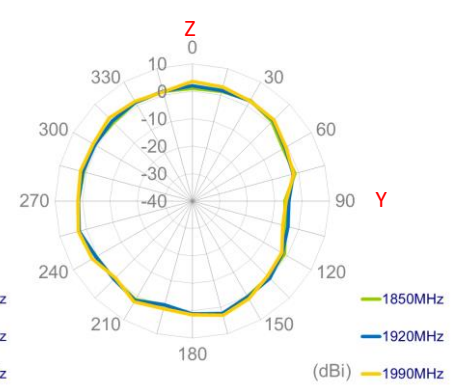
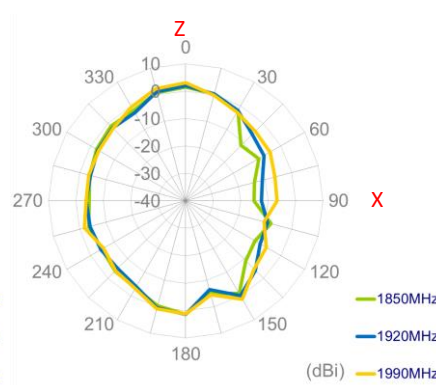
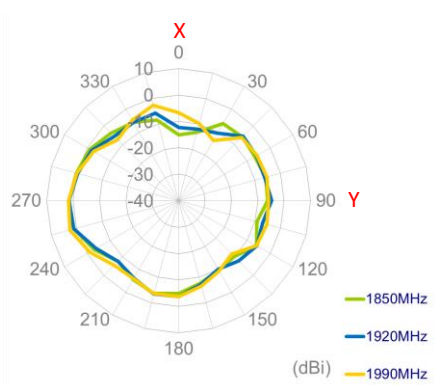

1990MHz

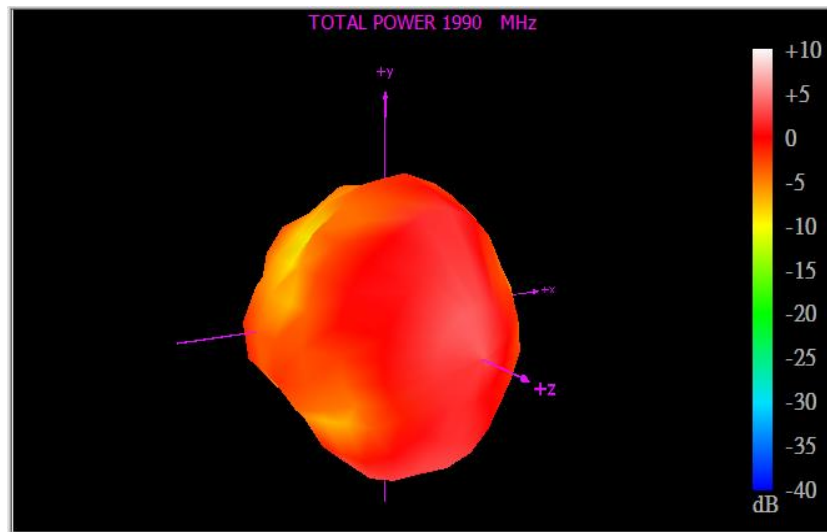

XY Plane

XZ Plane

YZ Plane

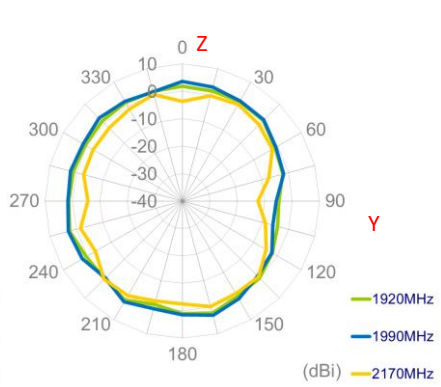
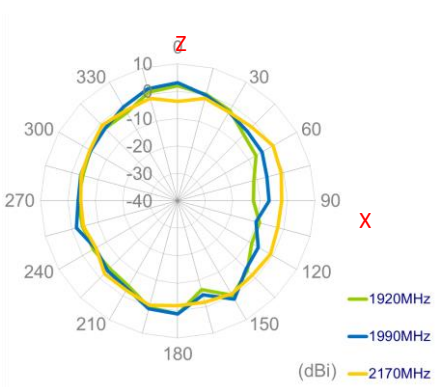
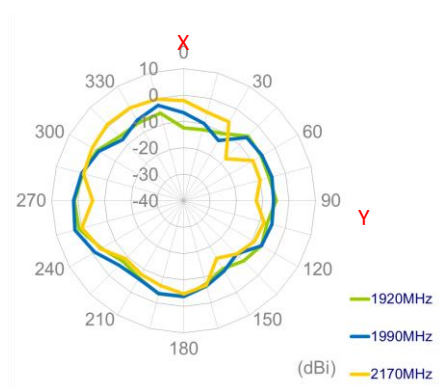

2500MHz

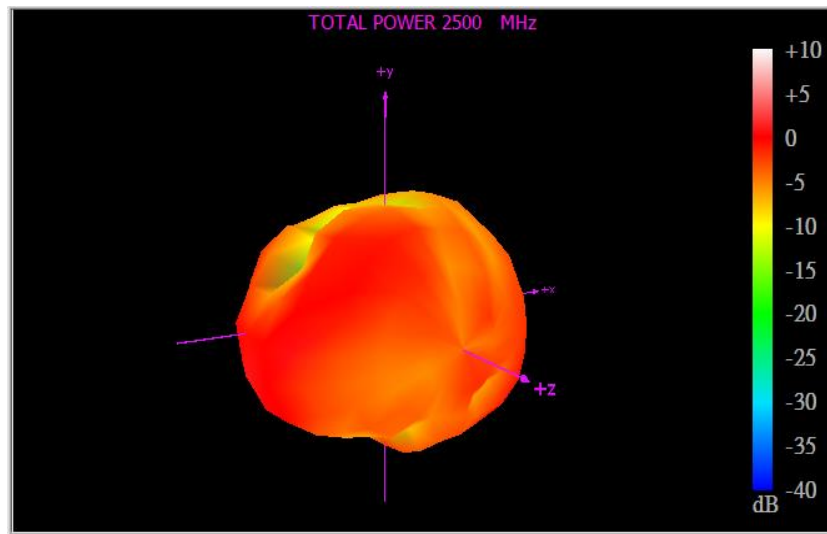

XY Plane

XZ Plane

YZ Plane

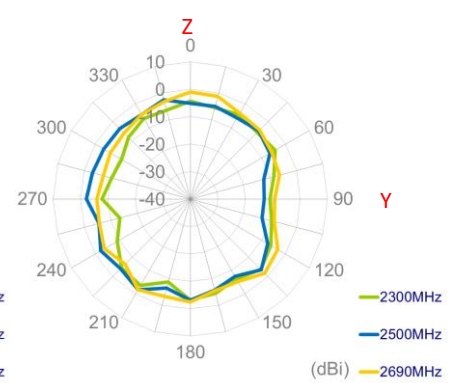
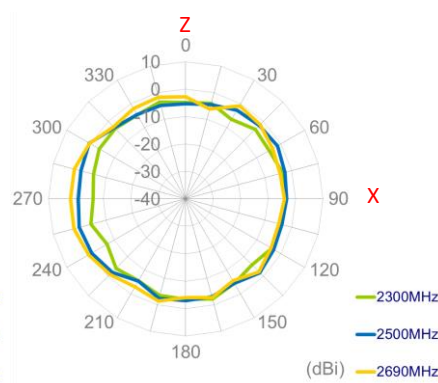
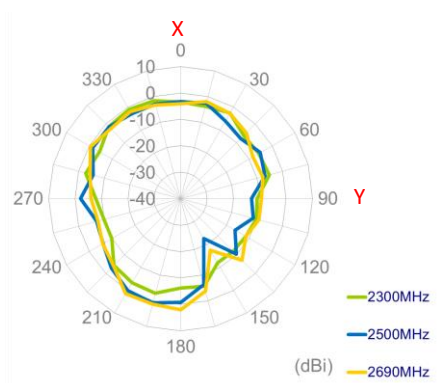

5.5 Cellular MIMO4 Radiation Pattern

751MHz

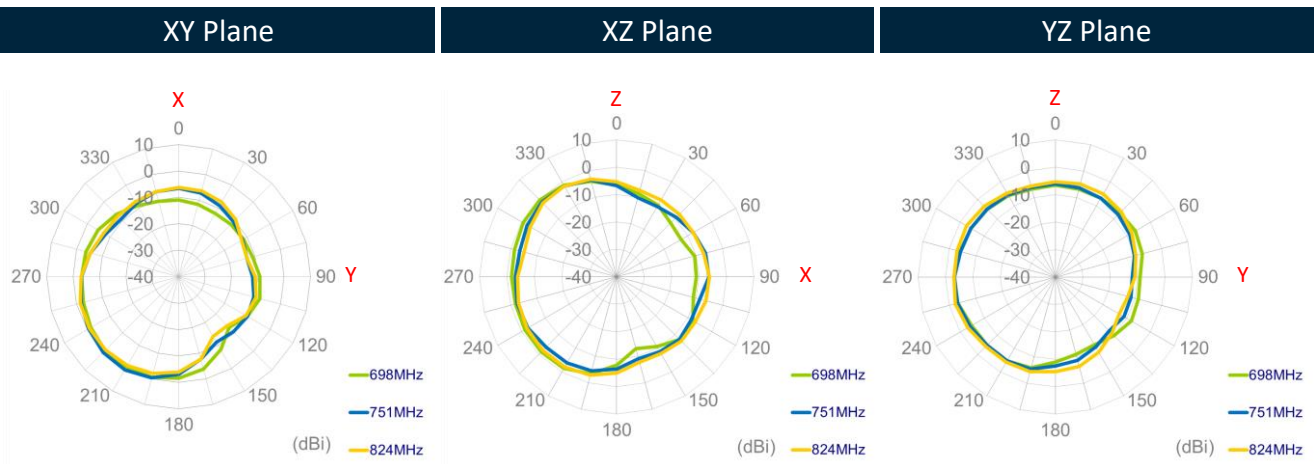
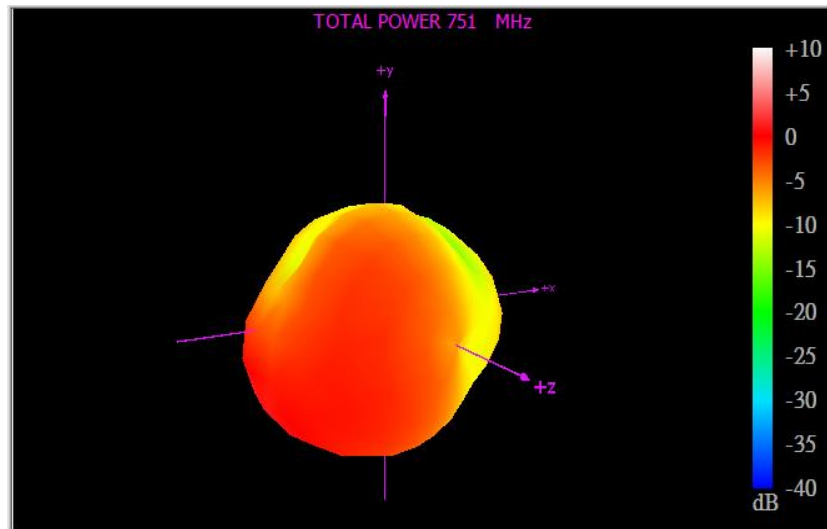

880MHz

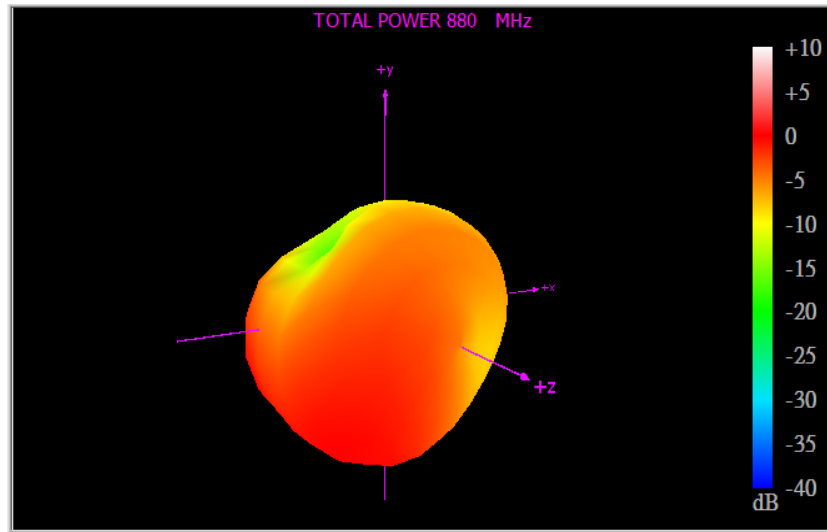

XY Plane XZ Plane YZ Plane

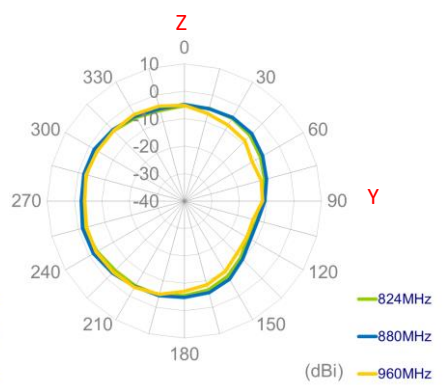
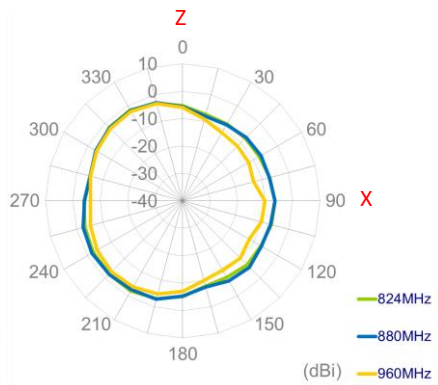
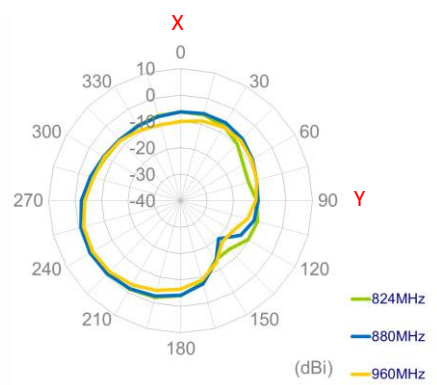

1805MHz

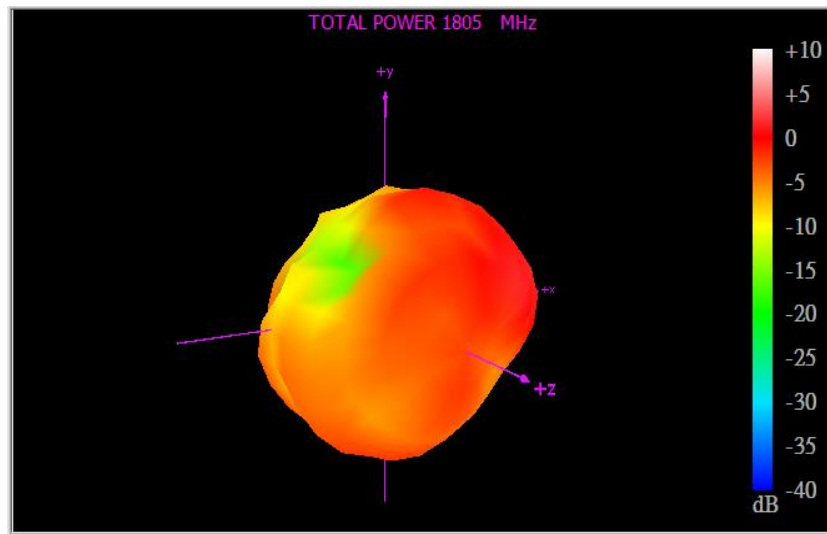

XY Plane

XZ Plane

YZ Plane

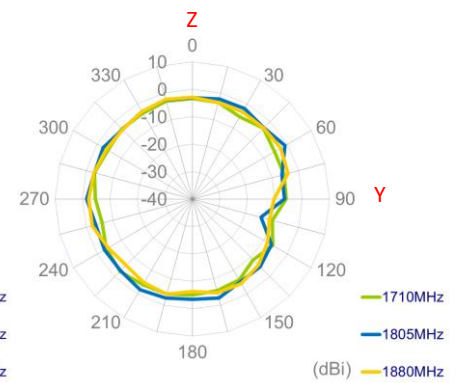
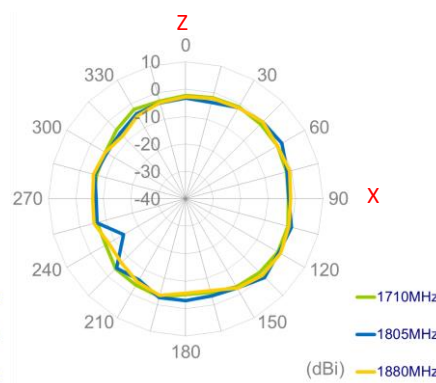
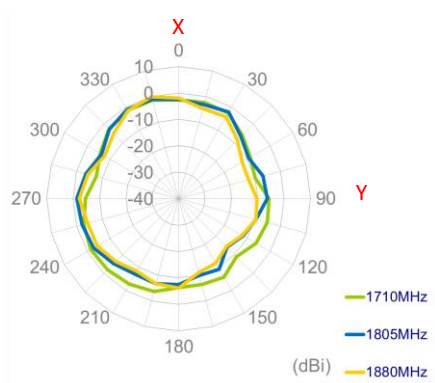

1920MHz

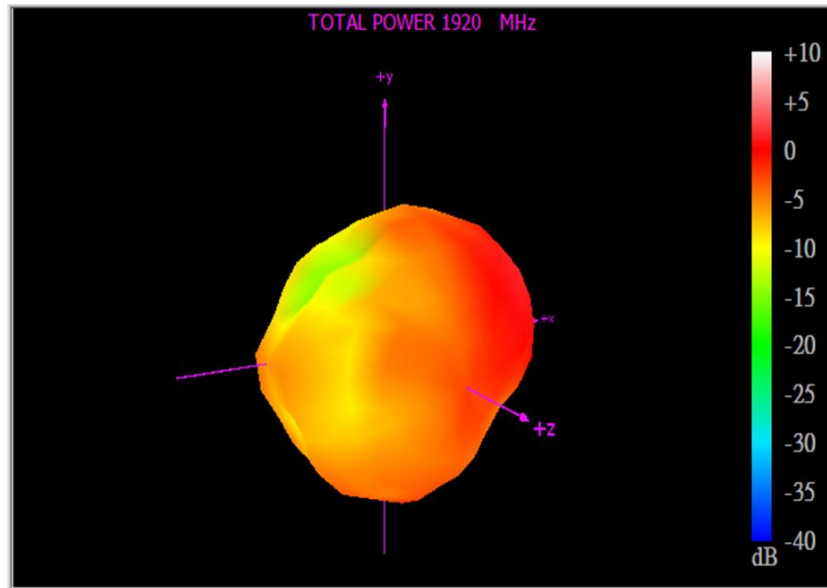

XY Plane XZ Plane YZ Plane

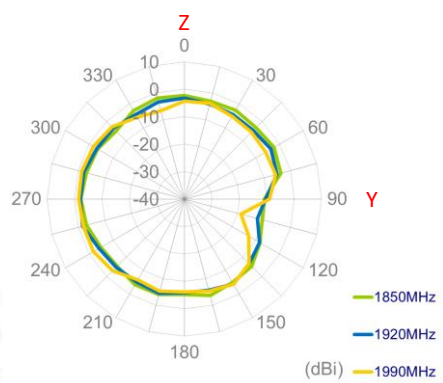
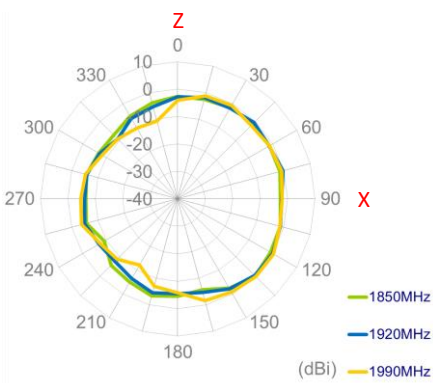
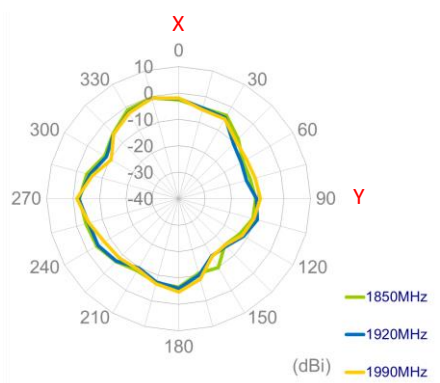

1990MHz

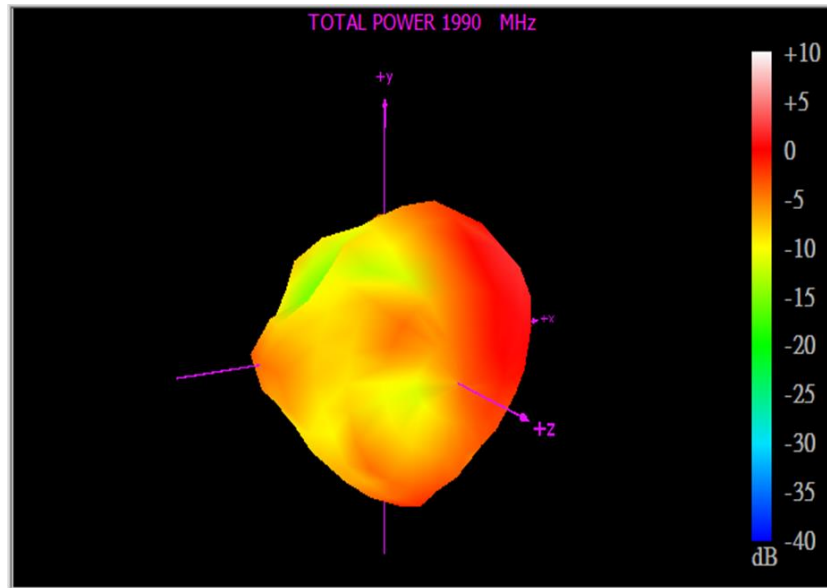

XY Plane XZ Plane YZ Plane

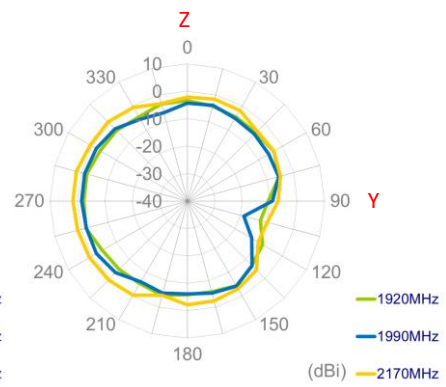
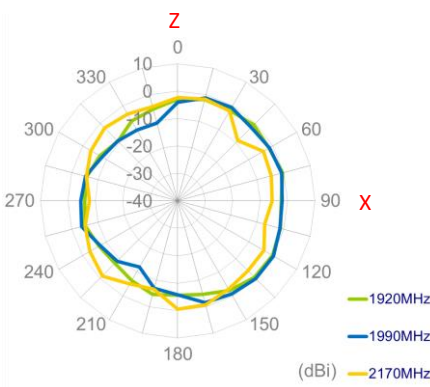
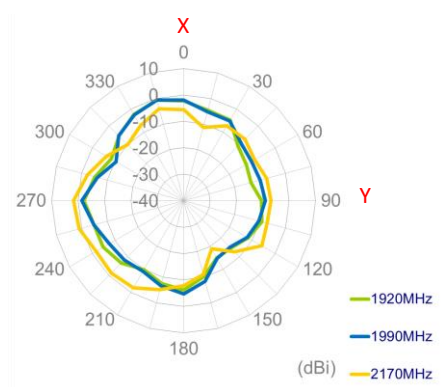

2500MHz

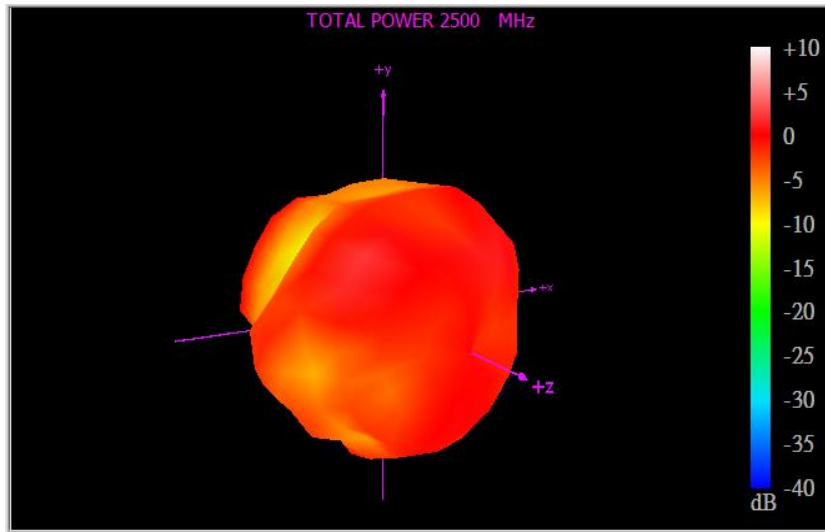

XY Plane

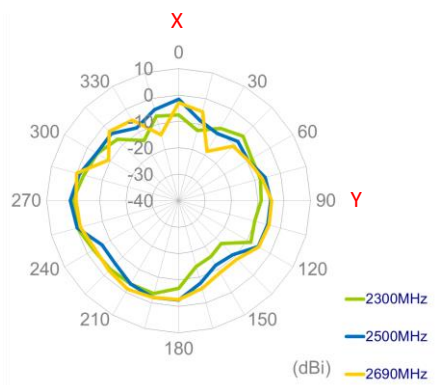

XZ Plane

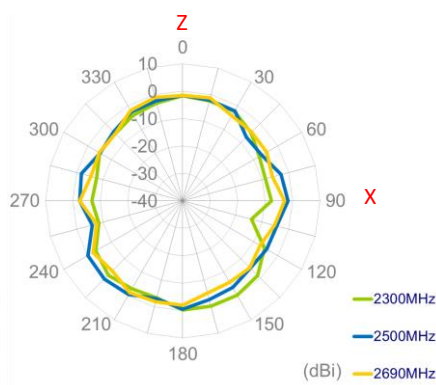

YZ Plane

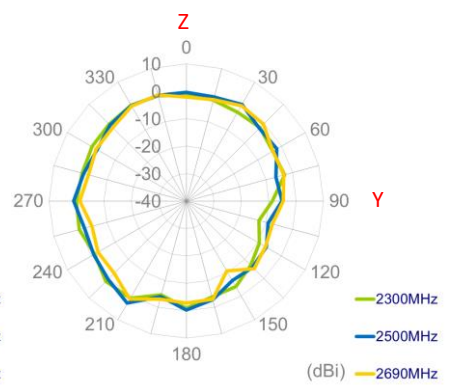

5.6 Cellular MIMO5 Radiation Pattern

751MHz

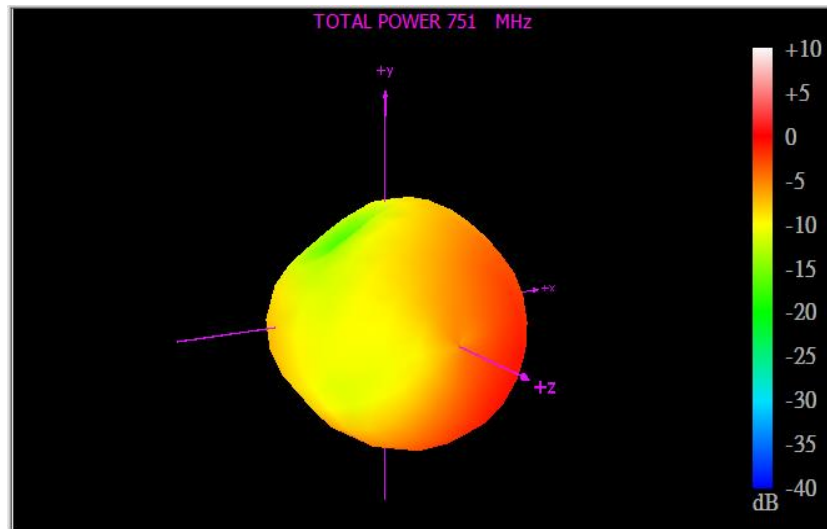

XY Plane

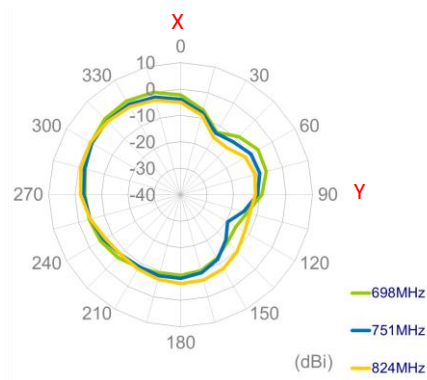

XZ Plane

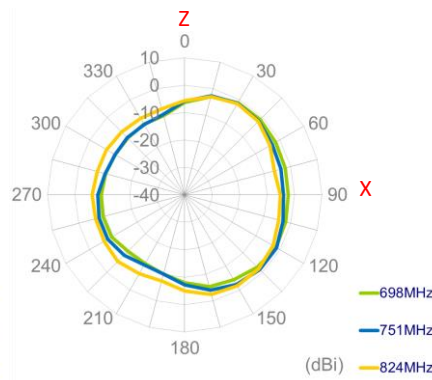

YZ Plane

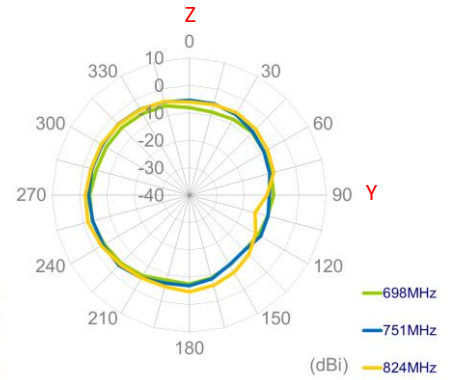

880MHz

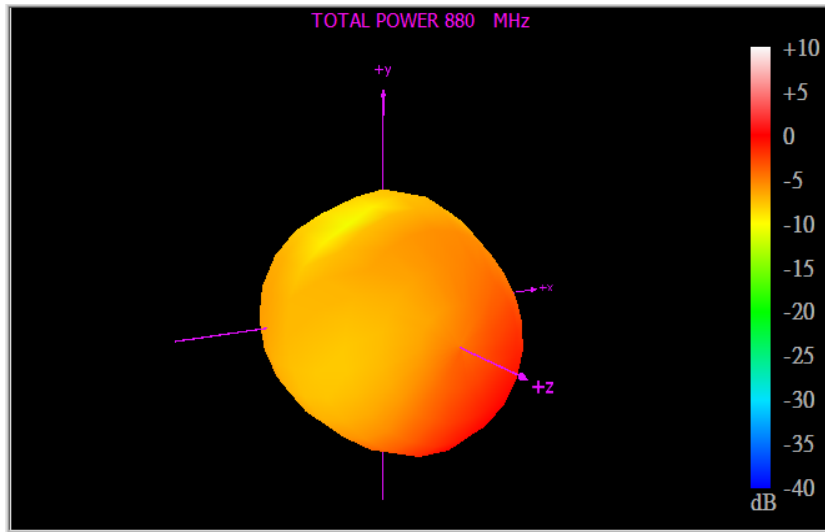

XY Plane

XZ Plane

YZ Plane

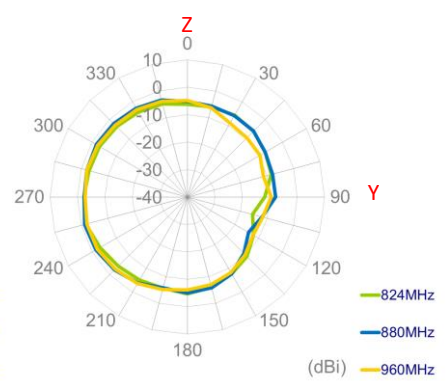
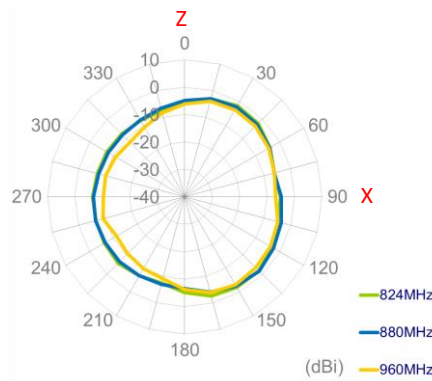
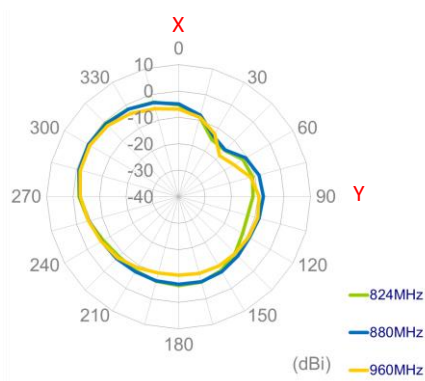

1805MHz

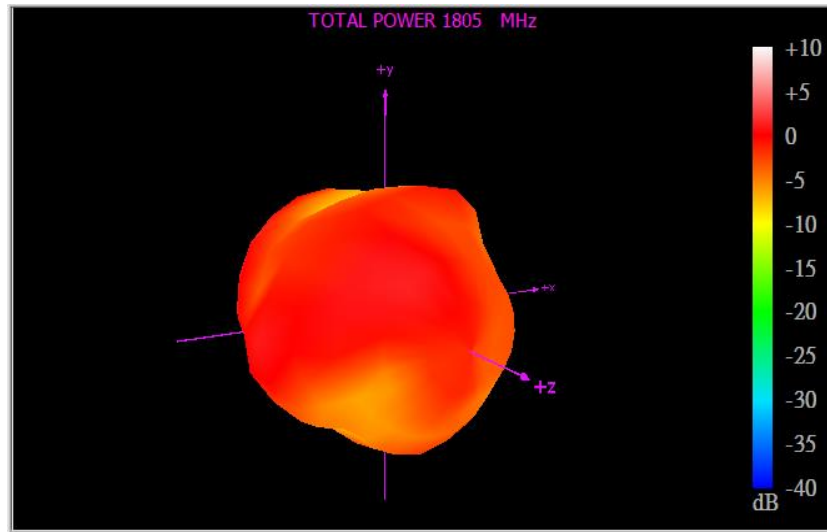

XY Plane

XZ Plane

YZ Plane

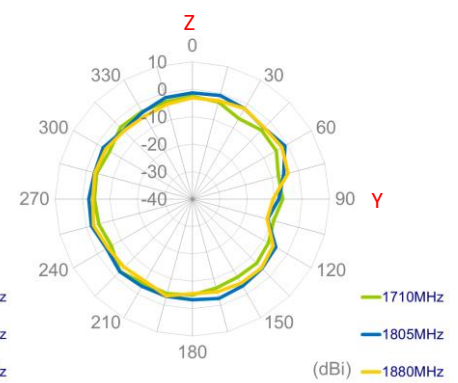
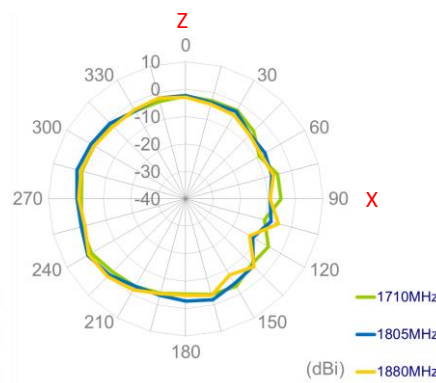
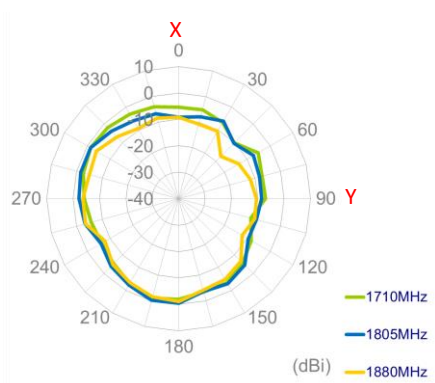

1920MHz

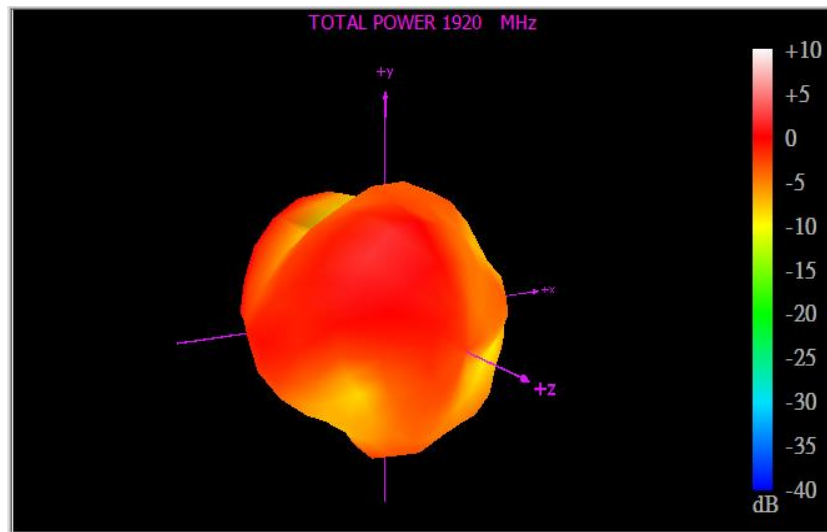

XY Plane XZ Plane YZ Plane

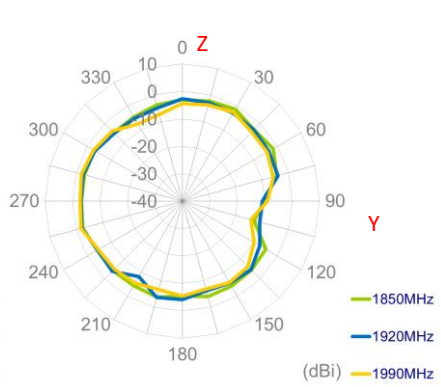
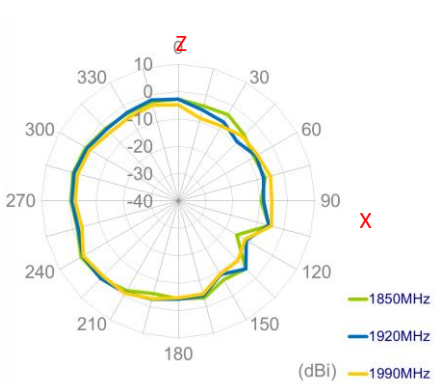
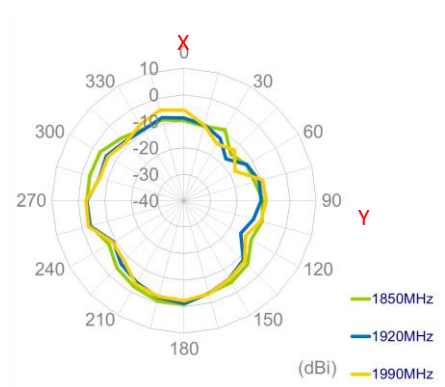

1990MHz

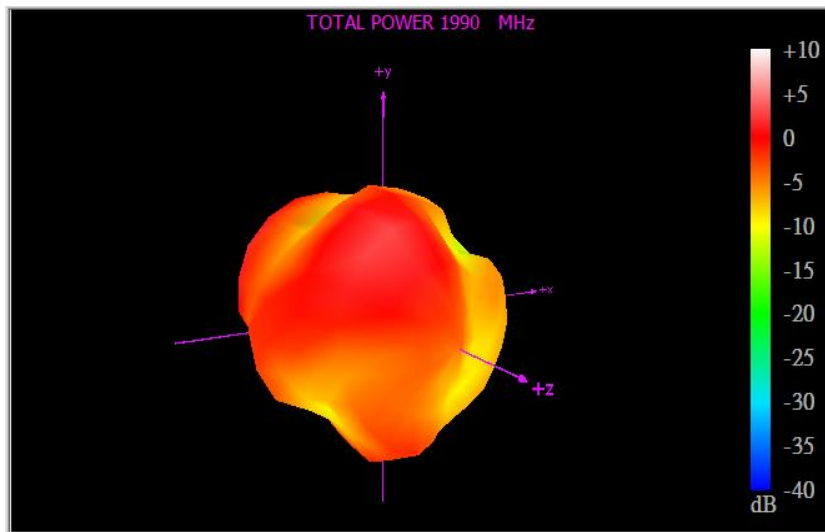

XY Plane XZ Plane YZ Plane

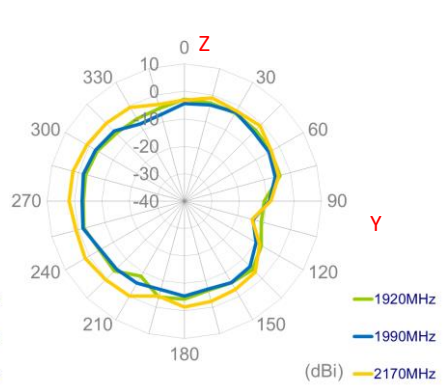
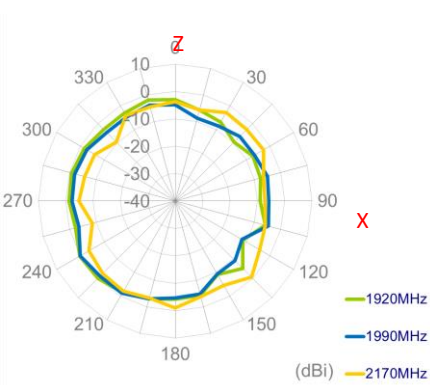
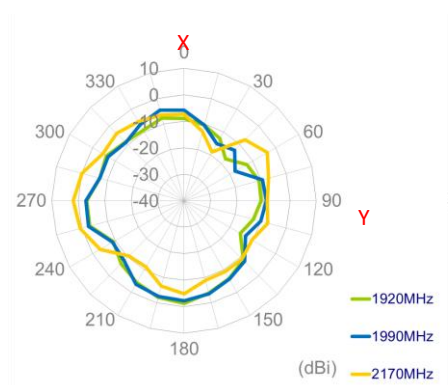

2500MHz

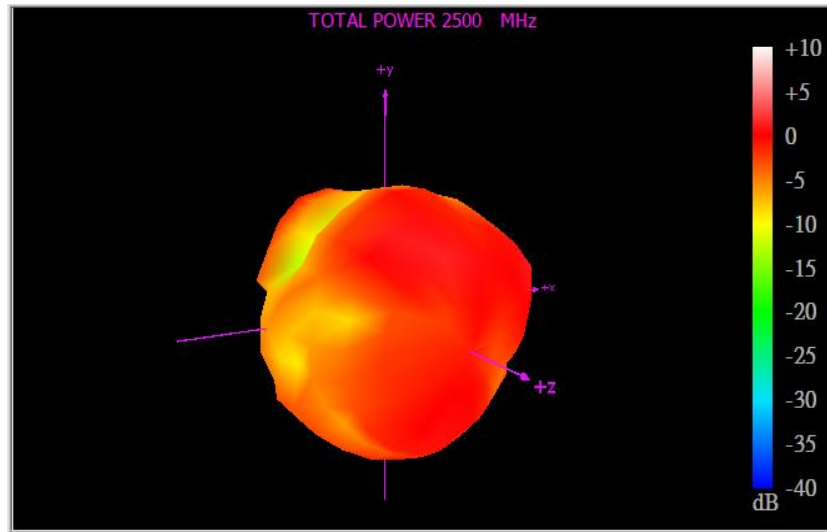

XY Plane

XZ Plane

YZ Plane

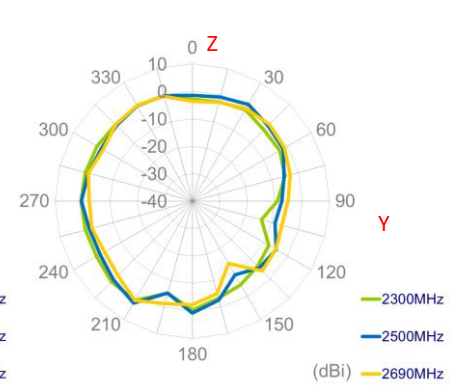
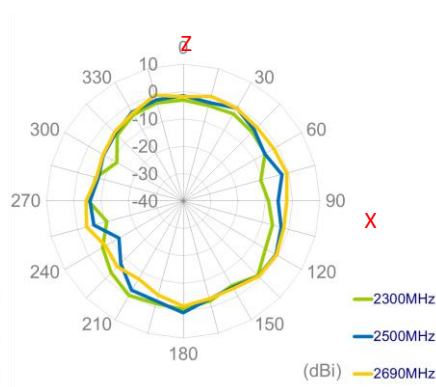
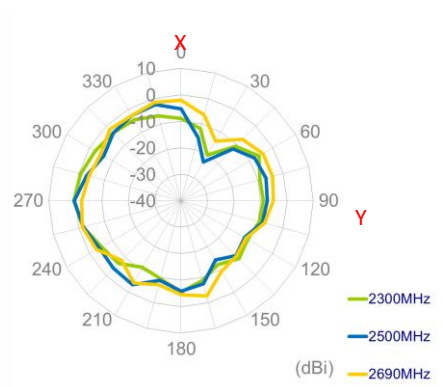

5.7 Cellular MIMO6 Radiation Pattern

751MHz

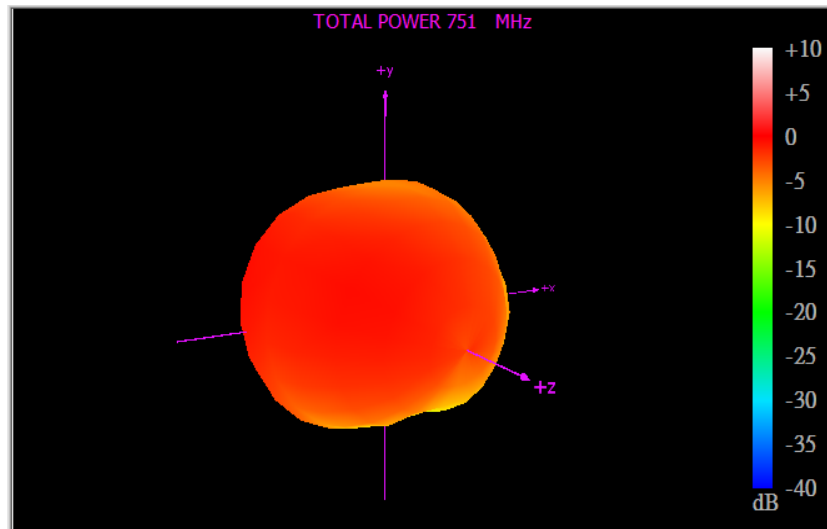

XY Plane

XZ Plane

YZ Plane

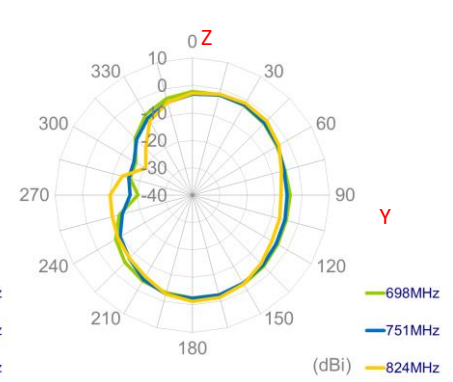
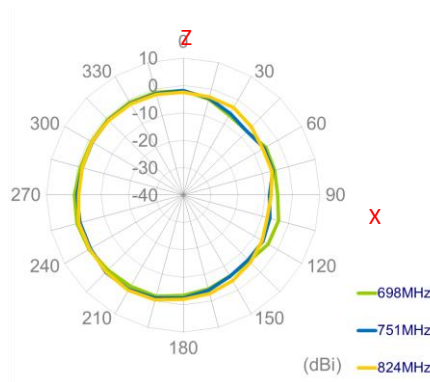
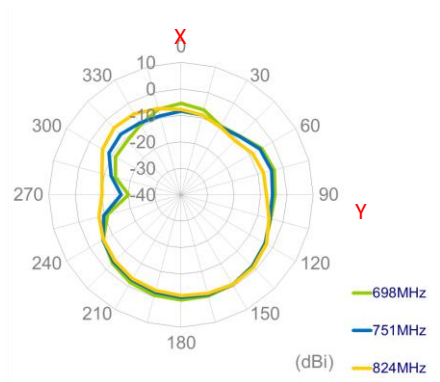

880MHz

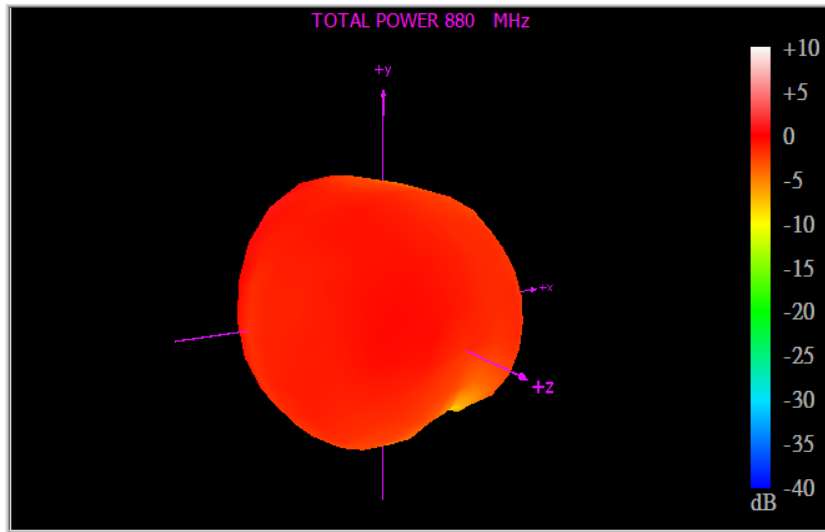

XY Plane

XZ Plane

YZ Plane

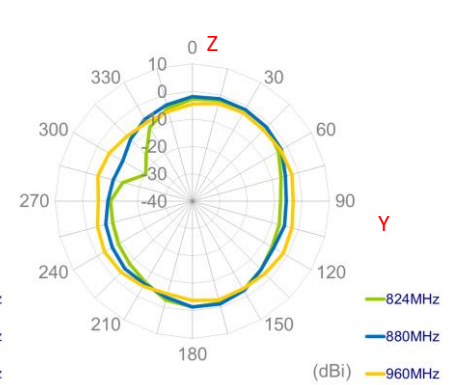
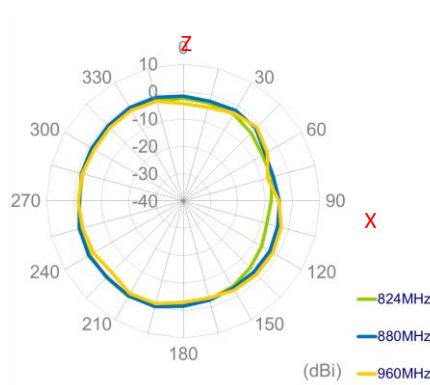
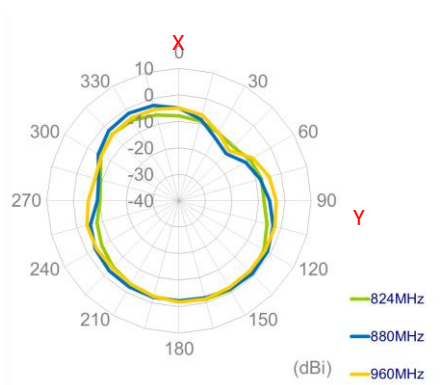

1805MHz

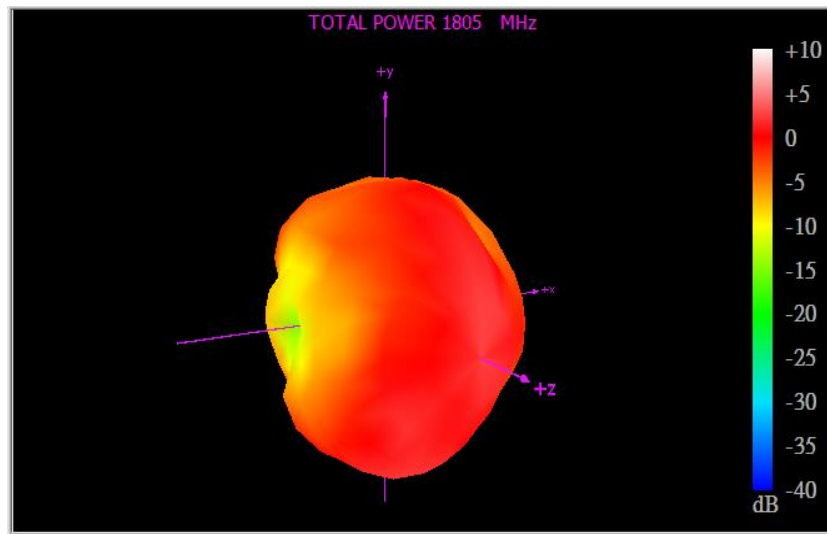

XY Plane

XZ Plane

YZ Plane

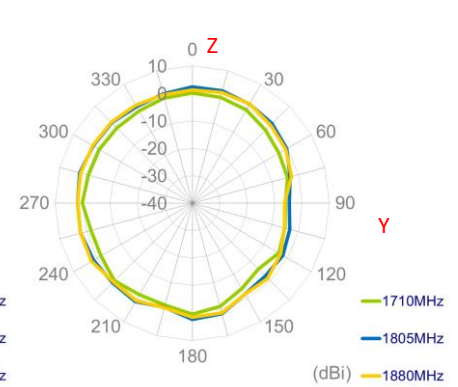
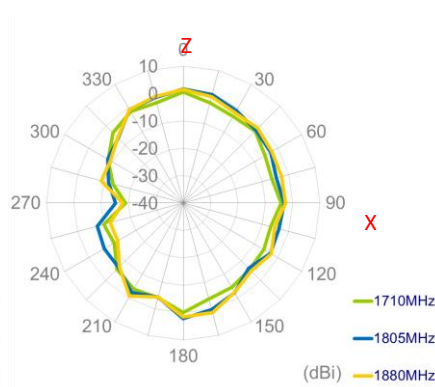
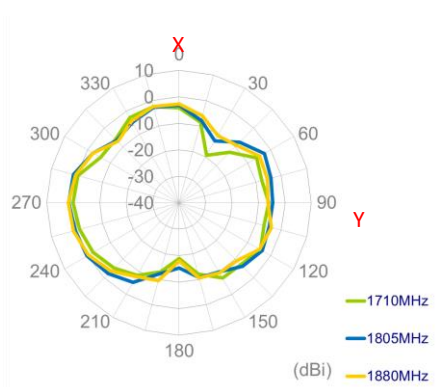

1920MHz

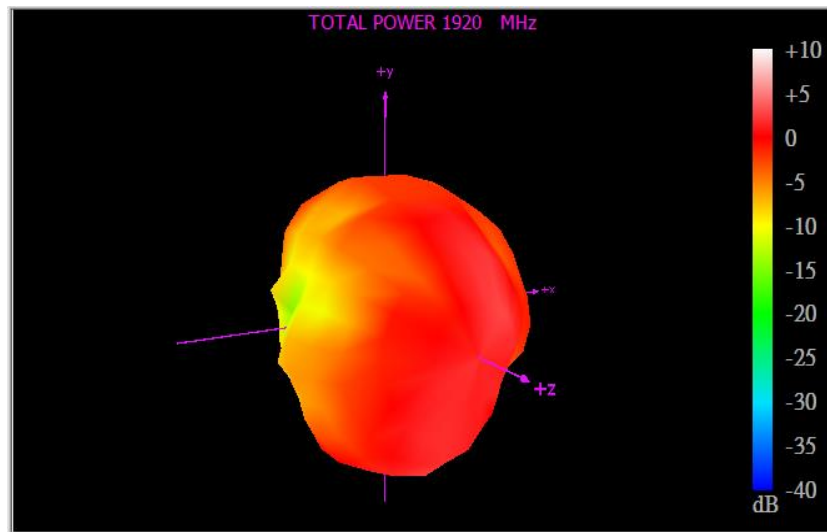

XY Plane

XZ Plane

YZ Plane

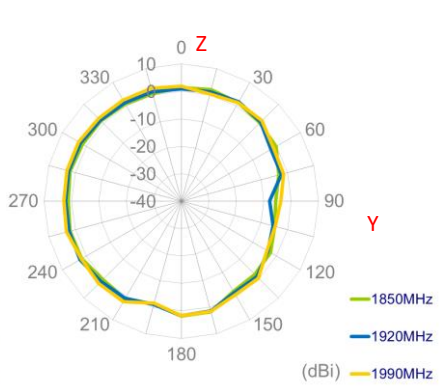
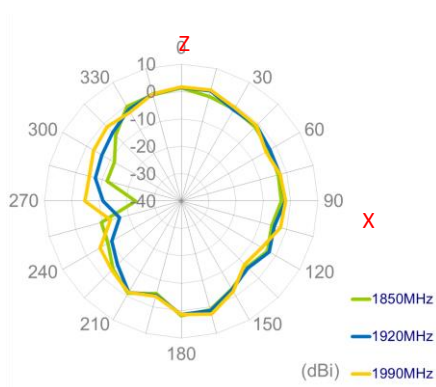
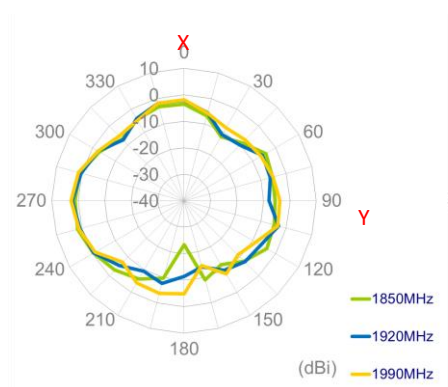

1990MHz

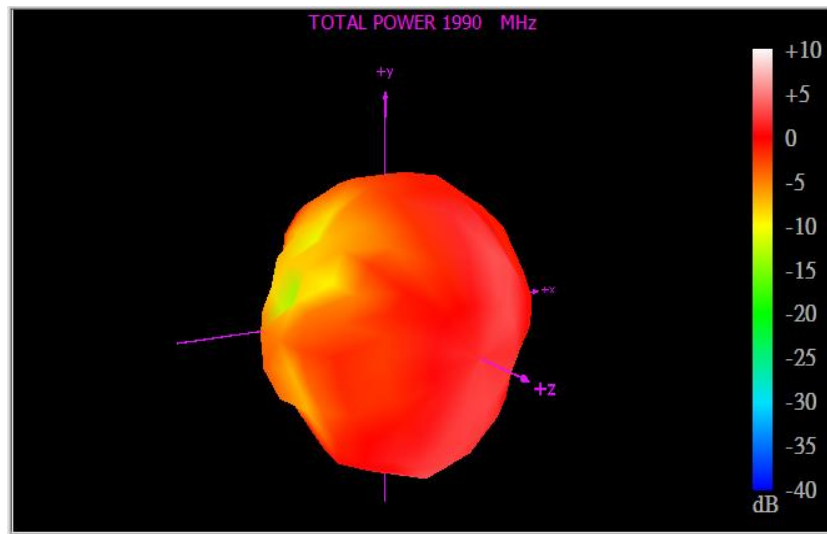

XY Plane

XZ Plane

YZ Plane

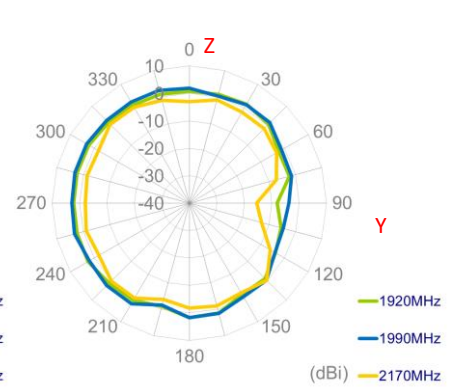
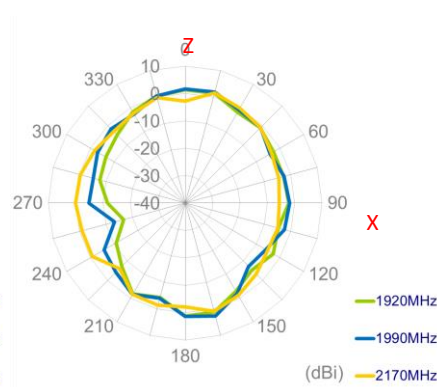
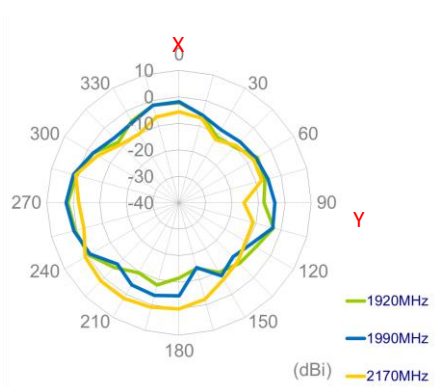

2500MHz

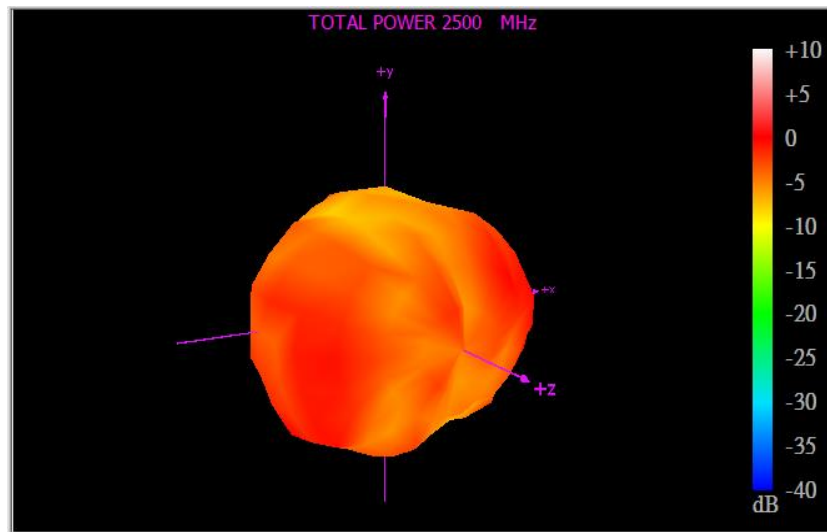

XY Plane

XZ Plane

YZ Plane

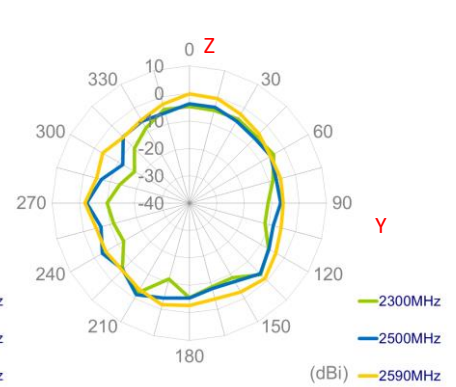
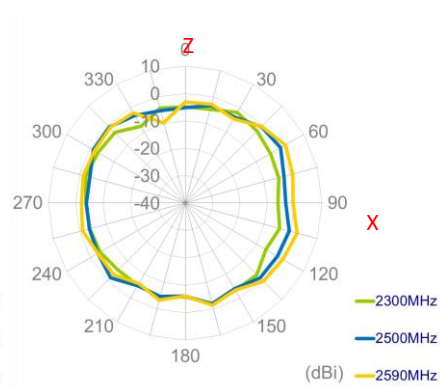
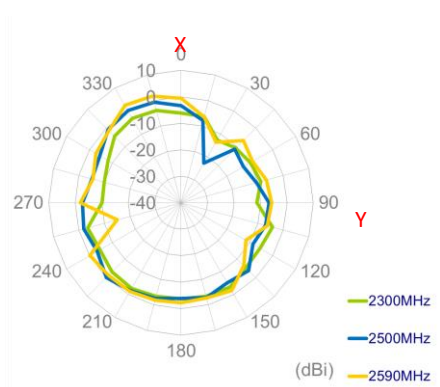

5.8 Cellular MIMO7 Radiation Pattern

751MHz

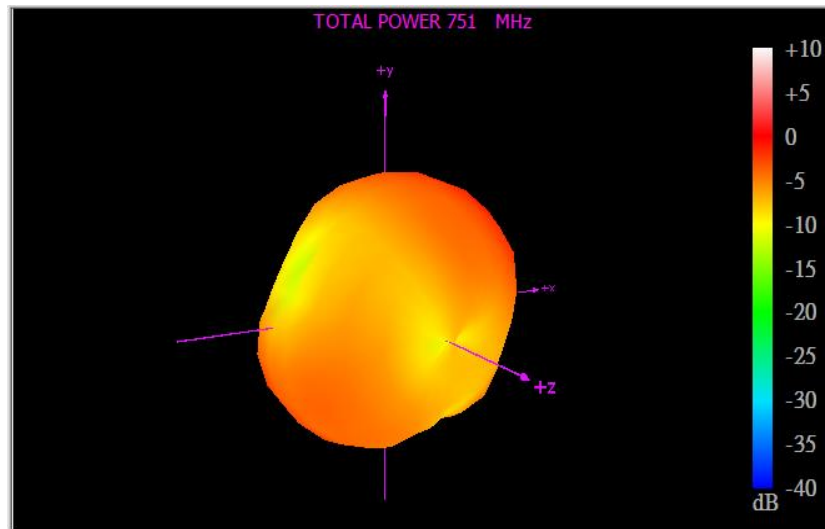

XY Plane XZ Plane YZ Plane

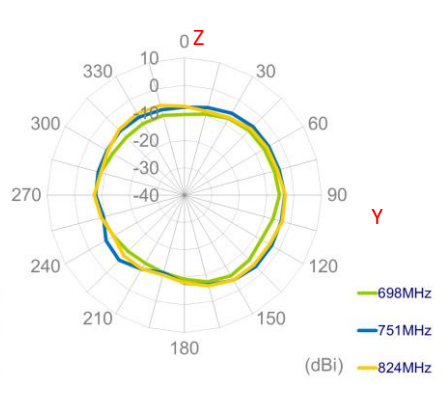
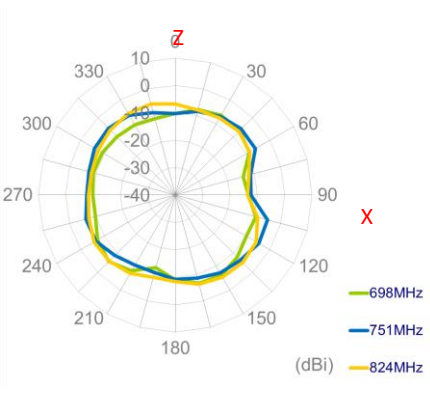
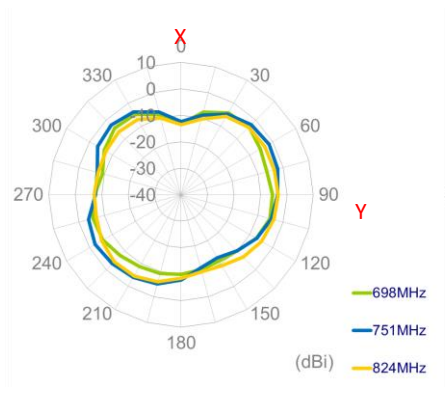

880MHz

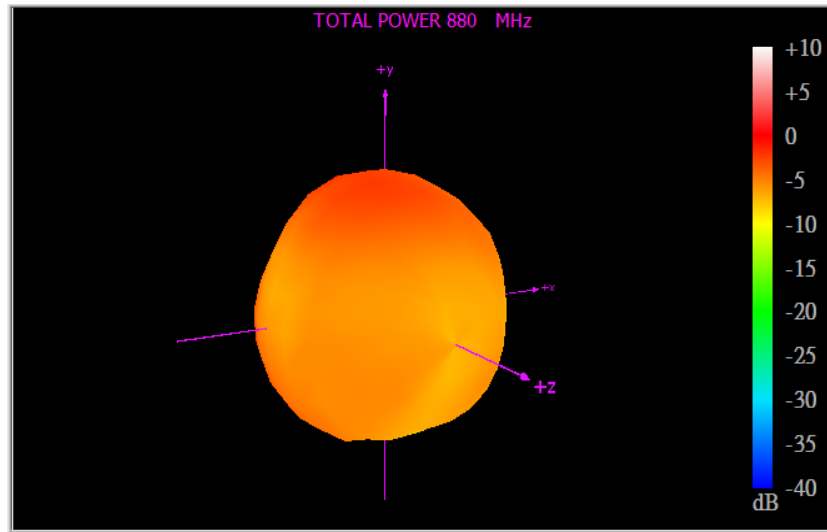

XY Plane

XZ Plane

YZ Plane

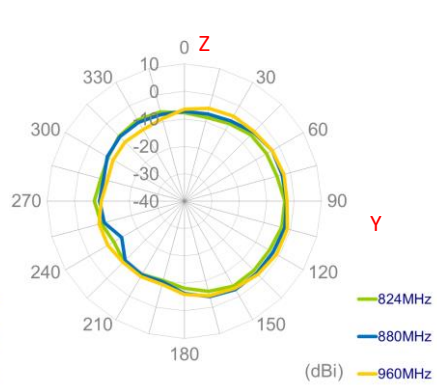
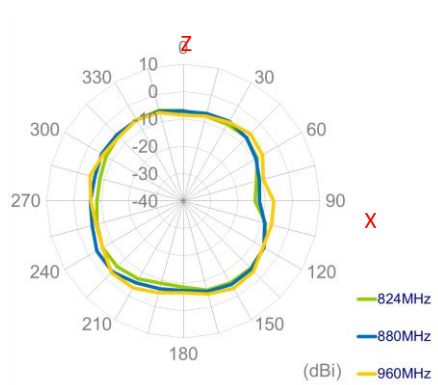
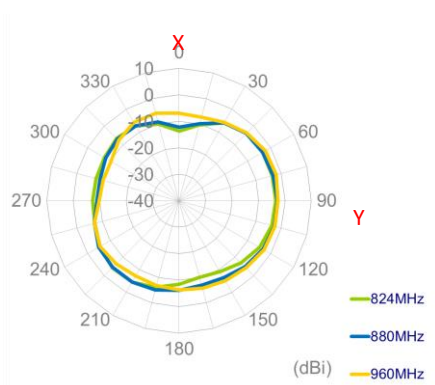

1805MHz

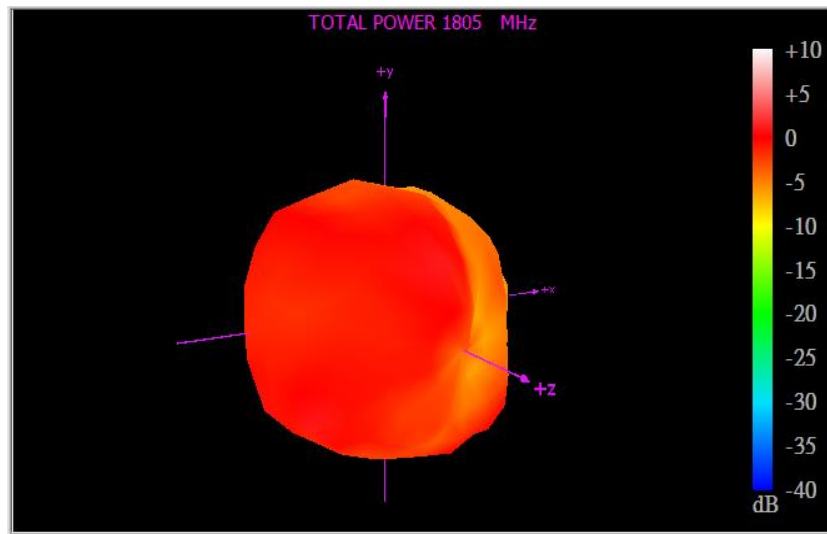

XY Plane

XZ Plane

YZ Plane

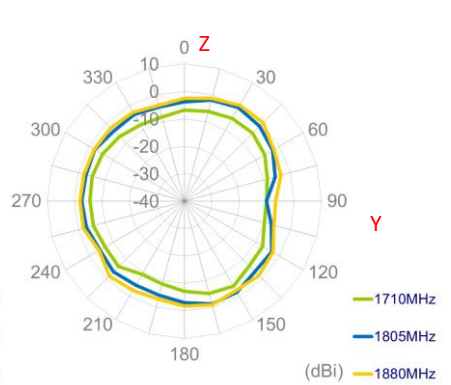
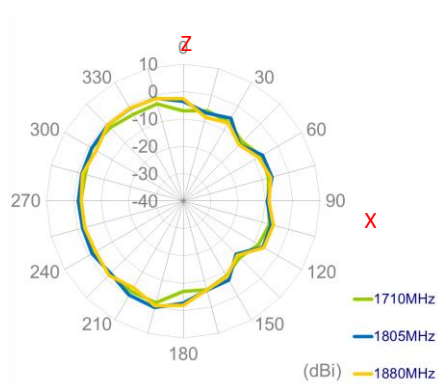
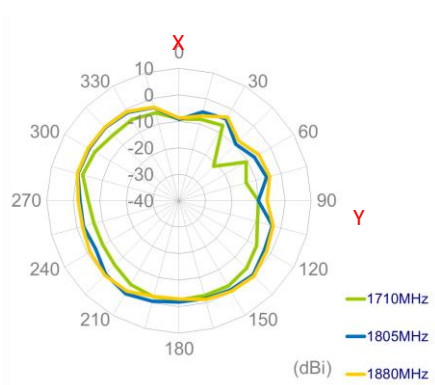

1920MHz

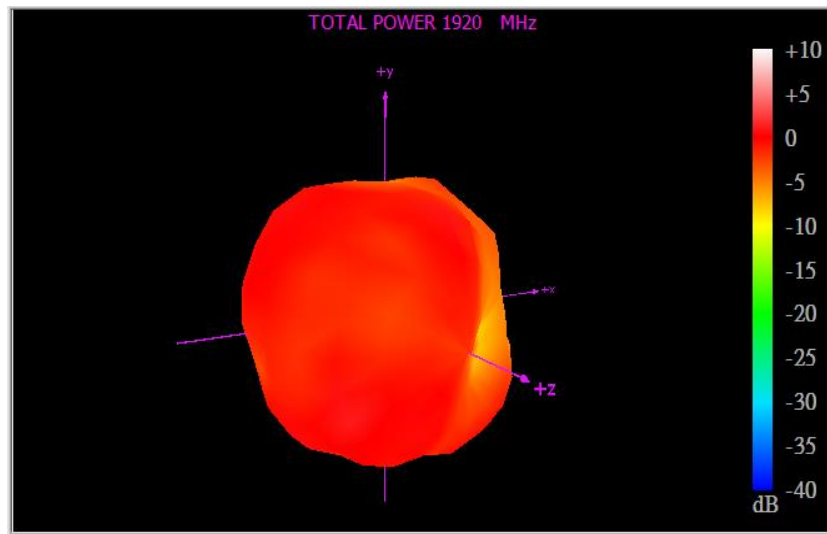

XY Plane XZ Plane YZ Plane

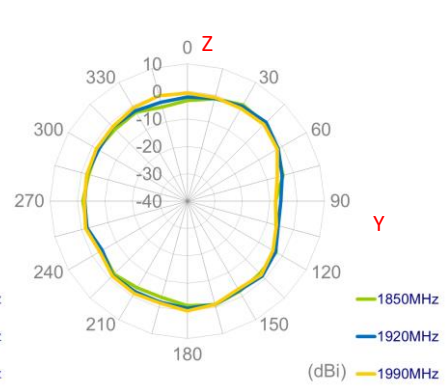
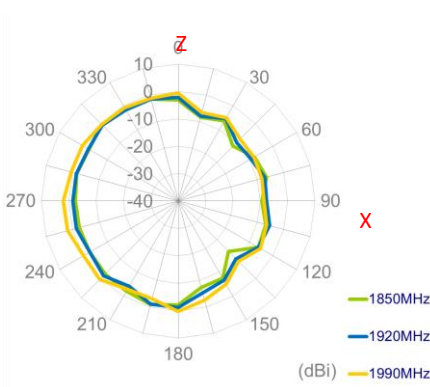
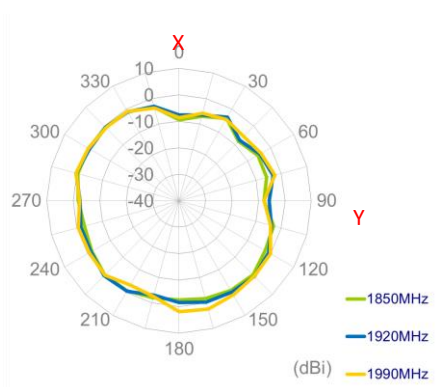

1990MHz

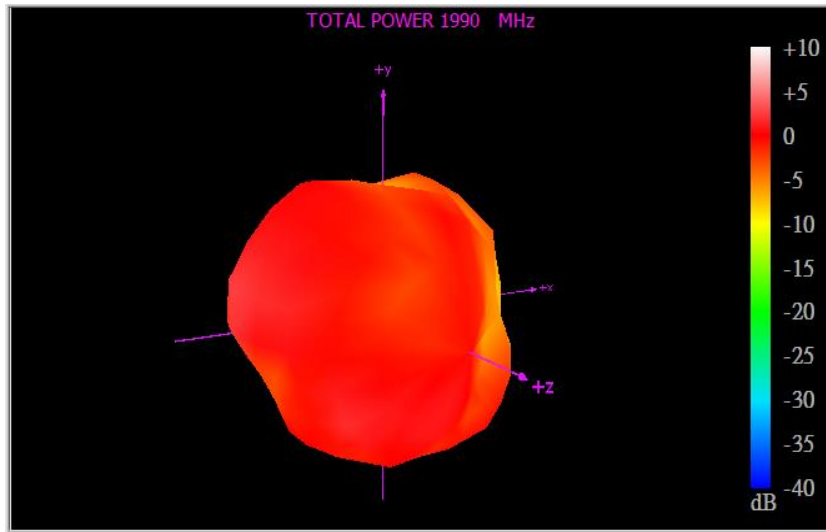

XY Plane XZ Plane YZ Plane

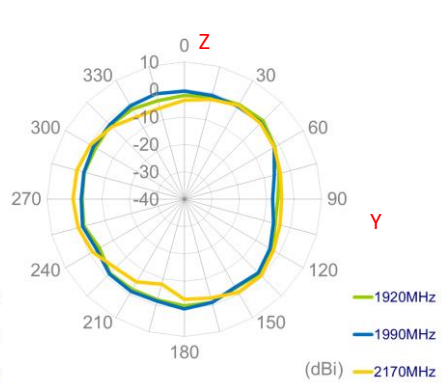
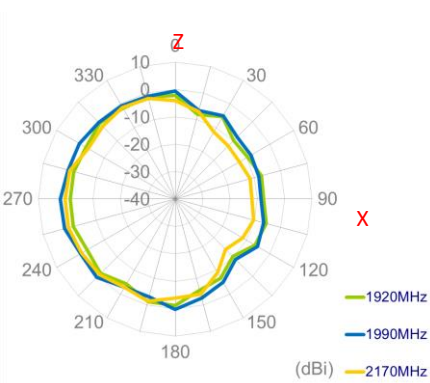
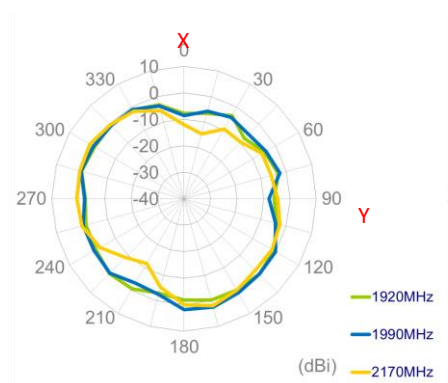

2500MHz

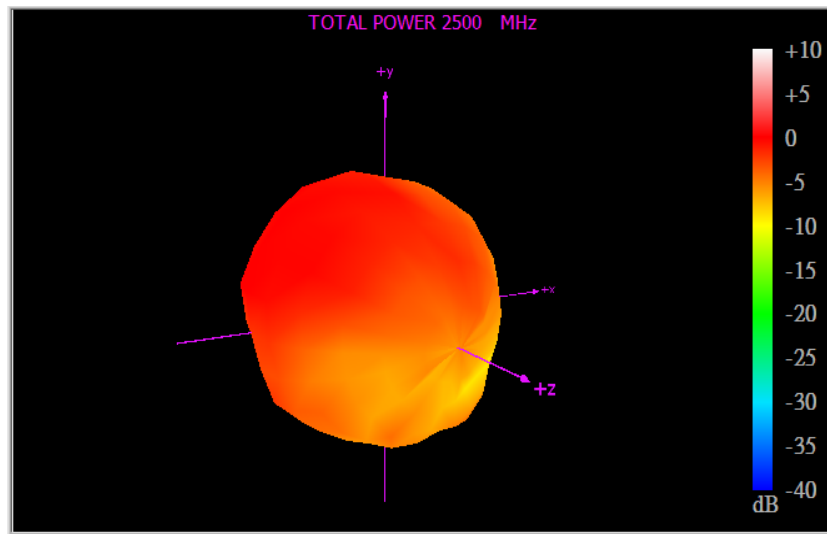

XY Plane XZ Plane YZ Plane

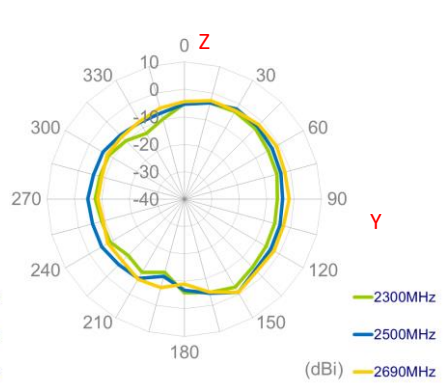
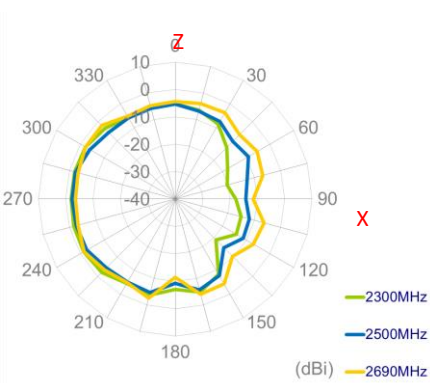
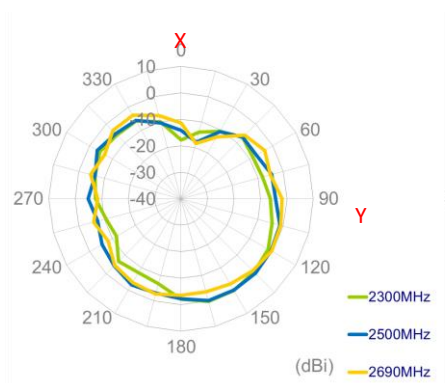

5.9 Cellular MIMO8 Radiation Pattern

751MHz

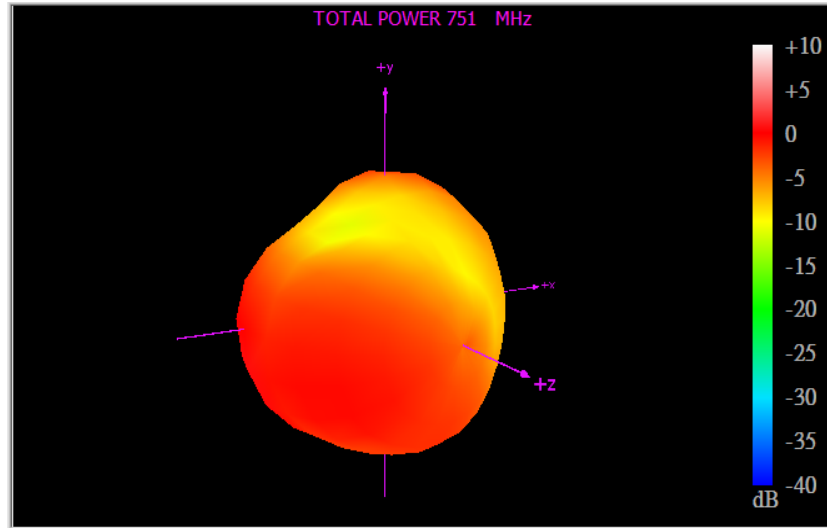

XY Plane

XZ Plane

YZ Plane

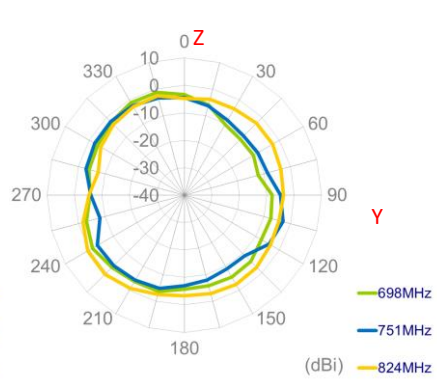
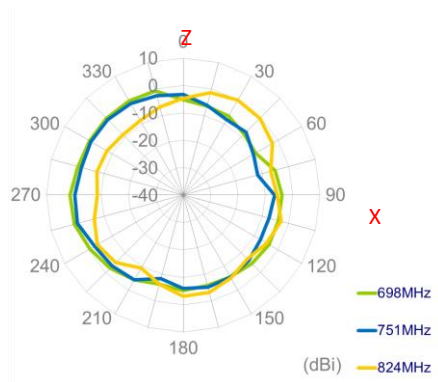
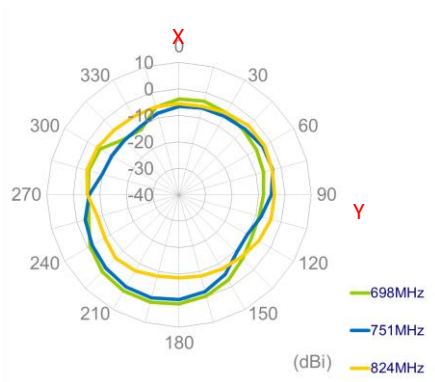

880MHz

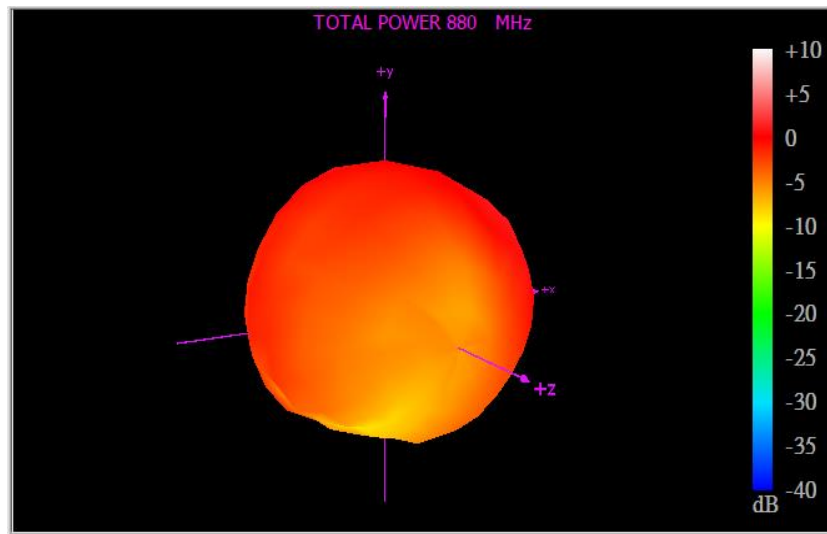

XY Plane

XZ Plane

YZ Plane

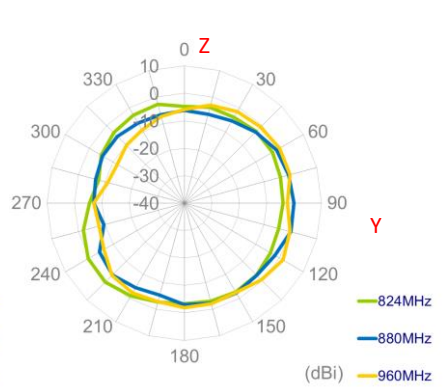
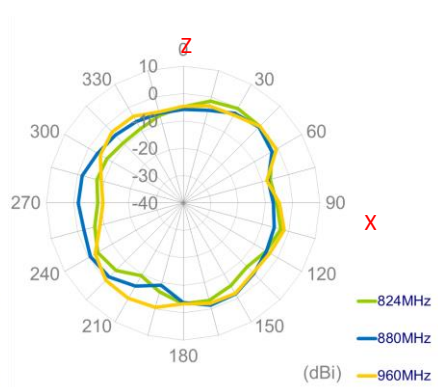
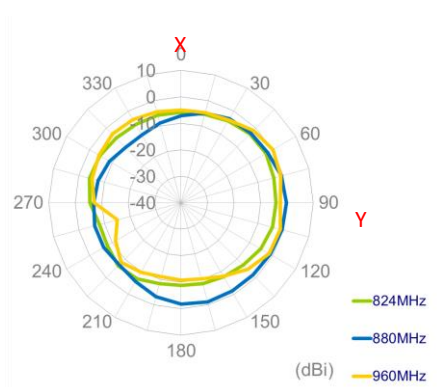

1805MHz

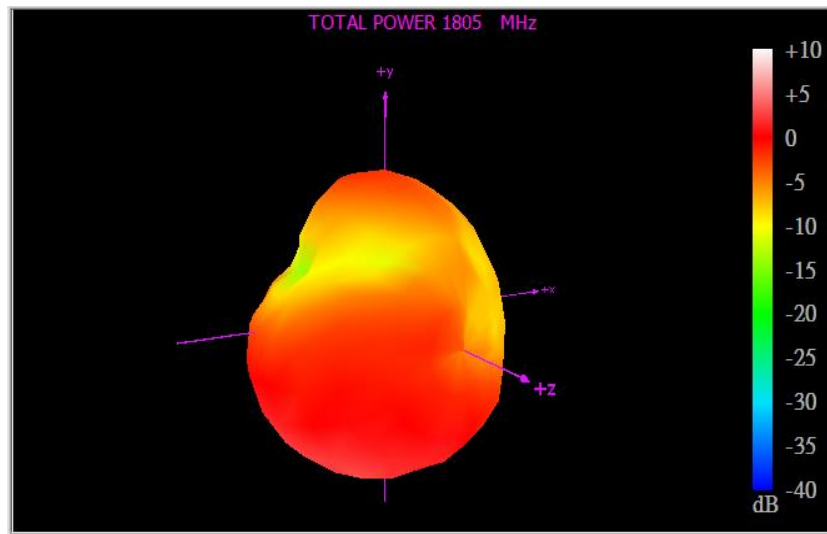

XY Plane

XZ Plane

YZ Plane

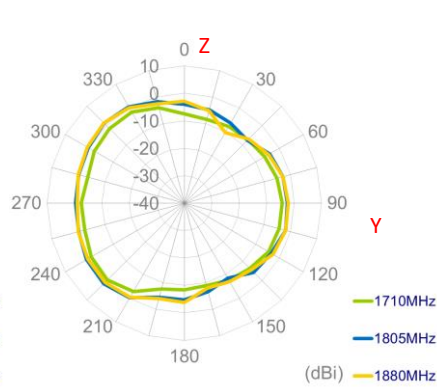
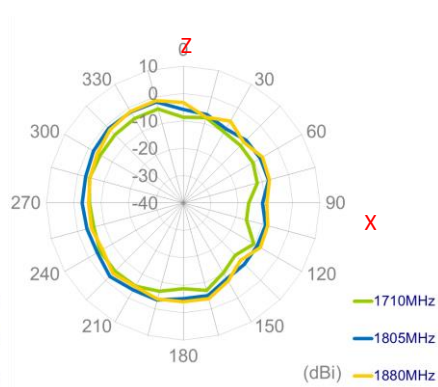
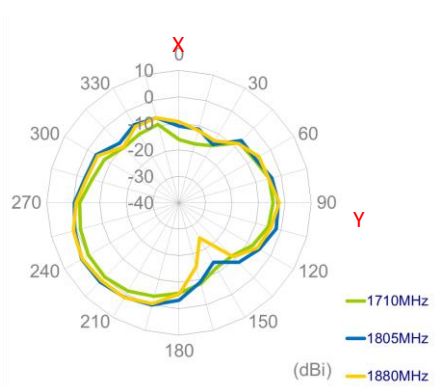

1920MHz

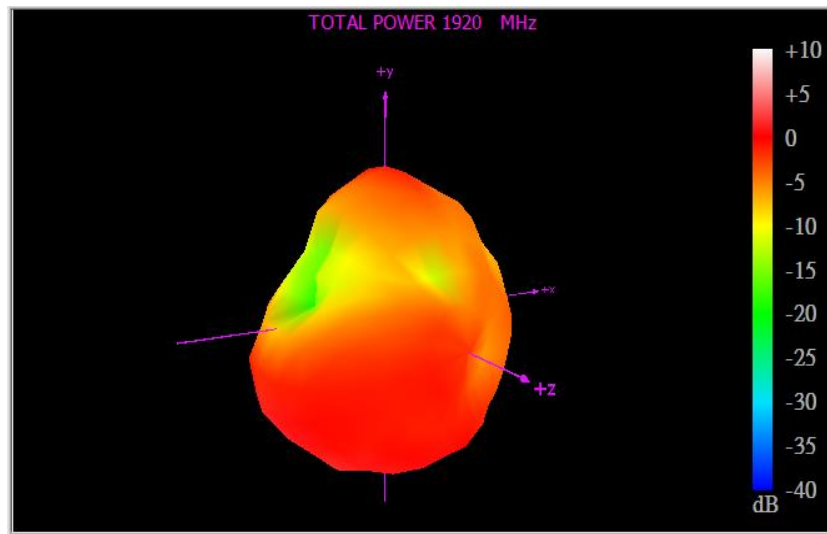

XY Plane

XZ Plane

YZ Plane

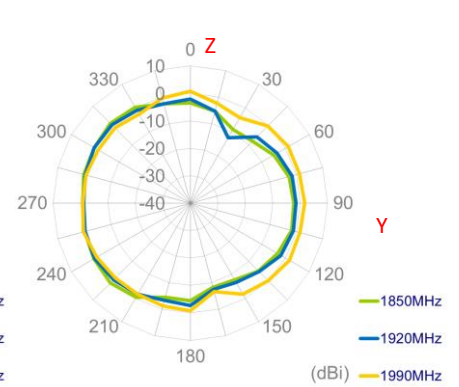
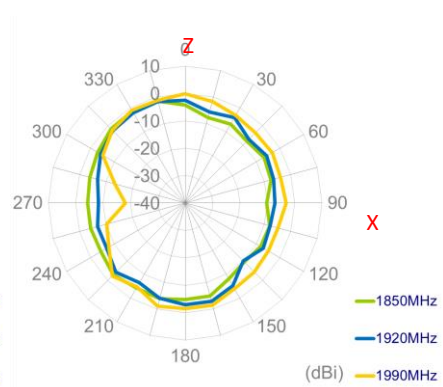
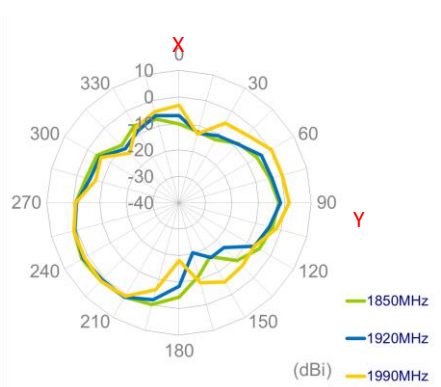

1990MHz

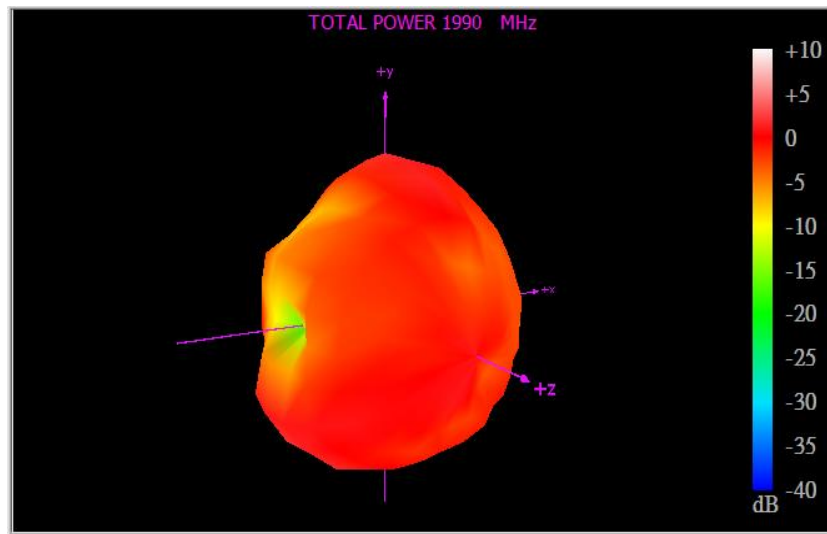

XY Plane

XZ Plane

YZ Plane

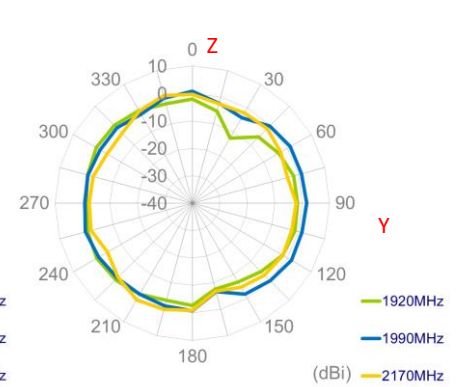
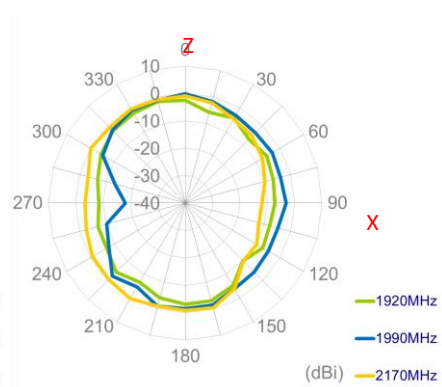
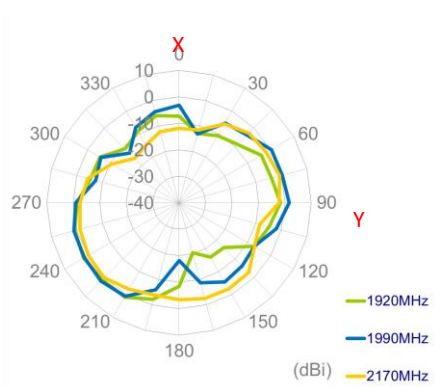

2500MHz

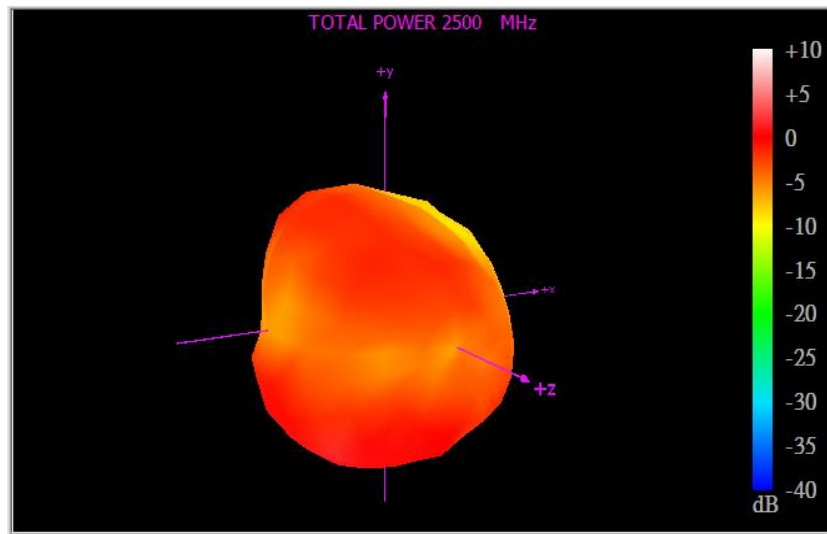

XY Plane XZ Plane YZ Plane

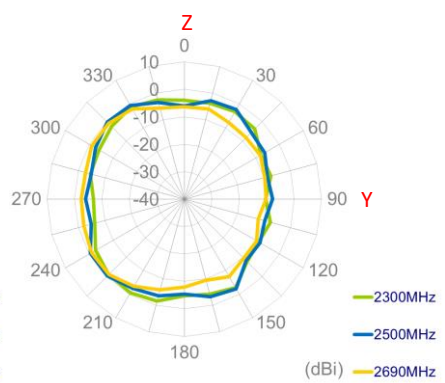
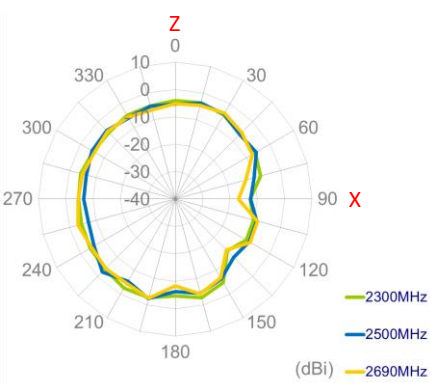
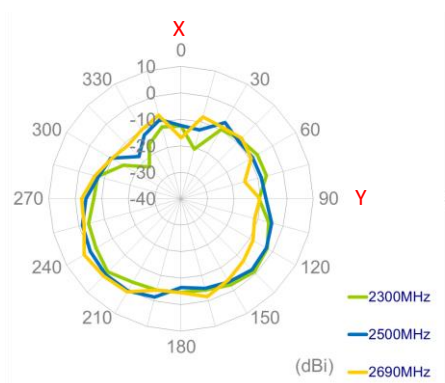

6. Mechanical Drawing (Units: mm)

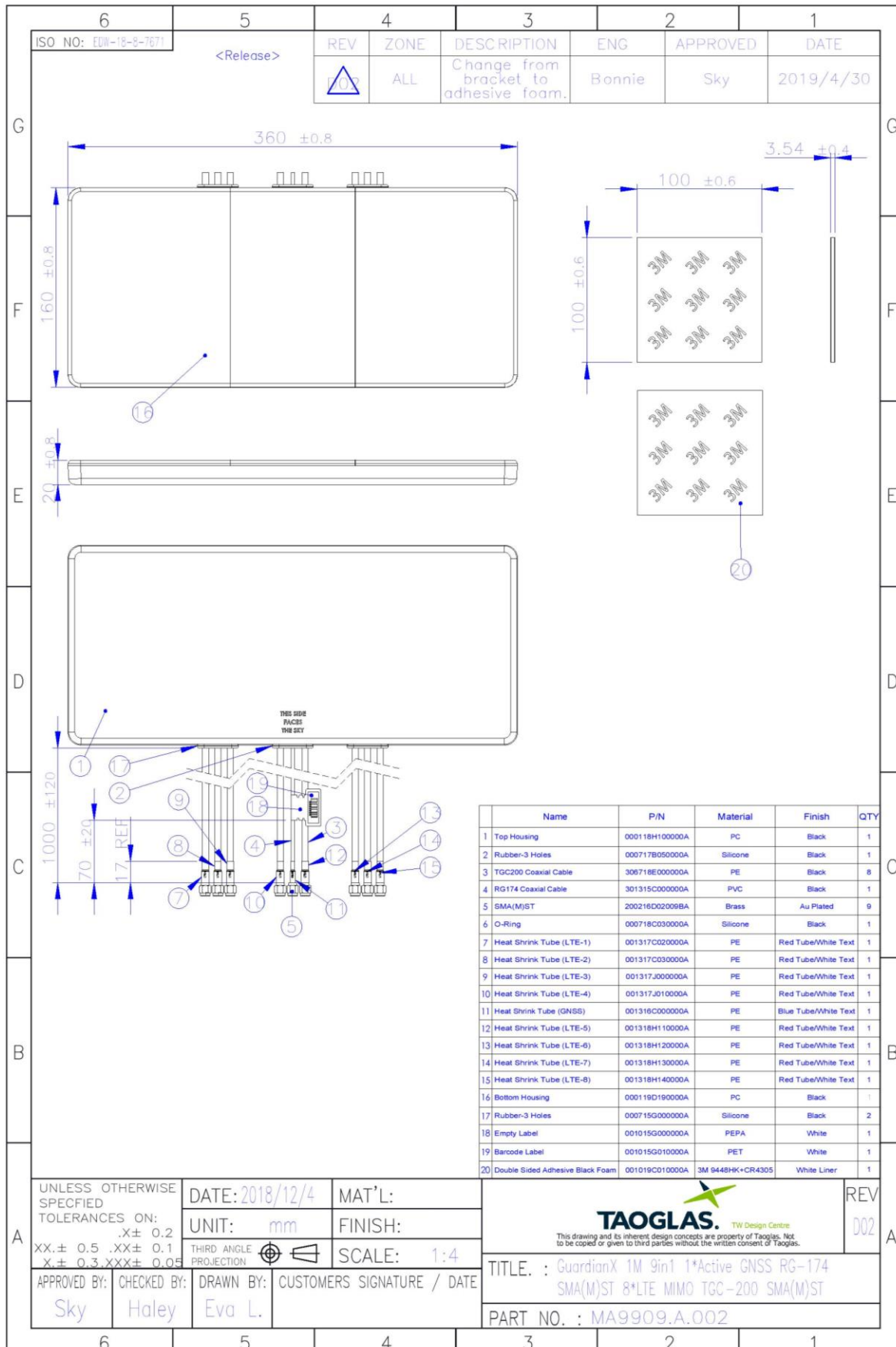

7. Packaging

1pc MA9909.A.002 per PE Bag
 Bag Dimensions - 364*524mm
 Weight - 1.068Kg

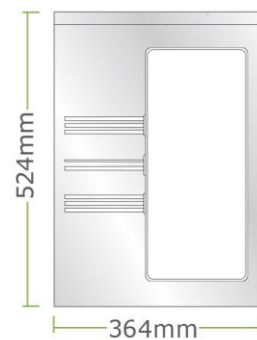

10pcs MA9909.A.002 per Carton
 Carton Dimensions - 430*380*280mm
 Weight - 11.6Kg

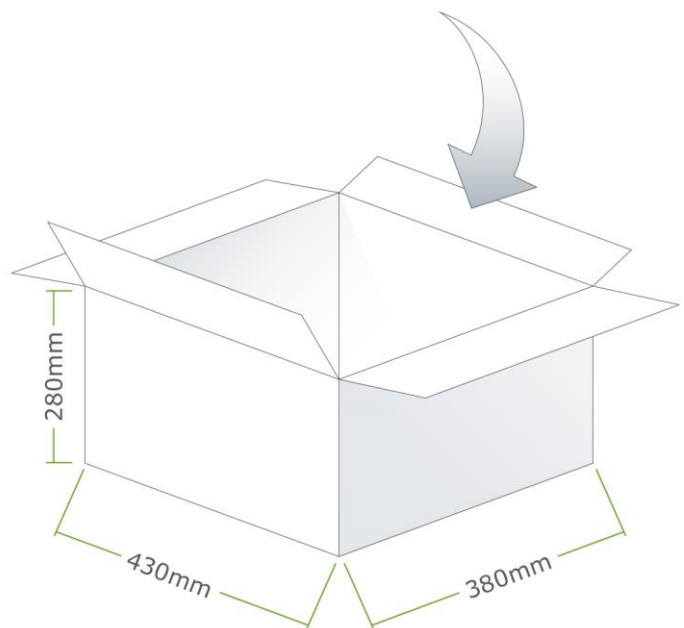

Pallet Dimensions:
 1200mm*1000mm*1280mm
 24 Cartons per Pallet
 6 Cartons per Layer, 4 Layers

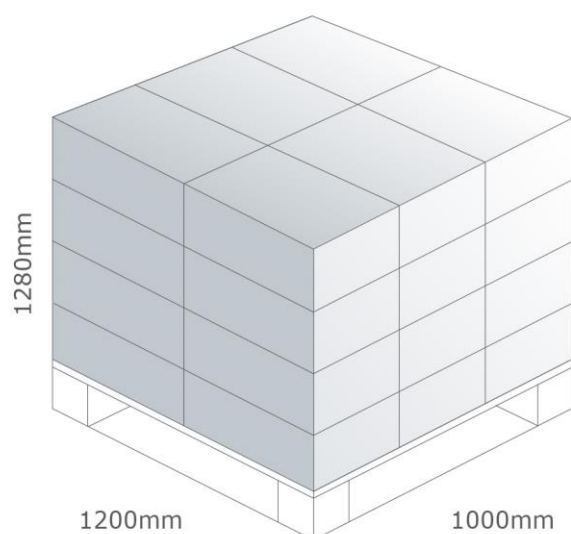

Changelog for the datasheet

SPE-19-8-131 – MA9909.A.002

Revision: A (Original First Release)

Date:	2019-10-08
Notes:	
Author:	Jack Conroy

Previous Revisions



TAOGLAS®

www.taoglas.com



X-ON Electronics

Largest Supplier of Electrical and Electronic Components

Click to view similar products for [Antennas](#) category:

Click to view products by [Taoglas](#) manufacturer:

Other Similar products are found below :

[GAN30084EU](#) [930-033-R](#) [GW17.07.0250E](#) [1513563-1](#) [EXE902SM](#) [APAMPG-117](#) [MAF94383](#) [W3908B0100](#) [W6102B0100](#) [YE572113-30RSMM](#) [108-00014-50](#) [66089-2406](#) [SPDA17RP918](#) [A09-F8NF-M](#) [A09-F5NF-M](#) [RGFRA1903041A1T](#) [W3593B0100](#) [W3921B0100](#) [SIMNA-868](#) [SIMNA-915](#) [SIMNA-433](#) [W1044](#) [W1049B090](#) [A75-001](#) [WTL2449CQ1-FRSMM](#) [CPL9C](#) [EXB148BN](#) [0600-00060](#) [TRA9020S3PBN-001](#) [Y4503](#) [GD5W-28P-NF](#) [MA9-7N](#) [GD53-25](#) [GD5W-21P-NF](#) [C37](#) [MAF94051](#) [MA9-5N](#) [EXD420PL](#) [B1322NR](#) [QWFTB120](#) [MAF94271](#) [MAF94300](#) [GPSMB301](#) [FG4403](#) [AO-AGSM-OM54](#) [5200232](#) [MIKROE-2349](#) [WCM.01.0111](#) [MIKROE-2393](#) [MIKROE-2352](#)