

Specification

- Part No. : **Shockwave TL.10.1HH11**
- Product Name : Wideband Direct Mount antenna
Covers all common
2G/3G/4G Cellular - ISM- Wi-Fi Bands
- Feature : LTE / GSM / CDMA /DCS /PCS / WCDMA / UMTS / HSDPA
/ GPRS / EDGE /GPS /Wi-Fi
698MHz to 960MHz, 1575.42MHz,
1710MHz to 2700Mhz,
Highest Efficiency and Peak Gain –up to 90%
IP67 Waterproof and IP69K
NMO (M) Connector
RoHS Compliant



1. Introduction

The Shockwave TL.10 NMO series is a new generation of antenna, one part number that is a highly efficient, high gain omni-directional permanent mount antenna designed for all common Cellular, Wi-Fi and ISM bands worldwide. It is specially designed for easy and cost effective vandal-proof and waterproof mounting requirements on meters, terminal boxes, and heavy equipment and vehicles.

In installation, the antenna connects to a NMO Mount connector jutting out from a metal panel. A unique indent tab on the base itself on the antenna allows a wrench to be used to solidly lock the antenna on top of its mounting location, thus preventing removal by hand later by vandals, but crucially allowing for replacement antenna to be installed by qualified personnel in the future without the need to open the device or box it is mounted on itself. A waterproof O-ring around the bottom outer edge prevents water leaking under the antenna.

The antenna is IP67 waterproof and IP69K resistant against high pressure water jets in commercial cleaning environments, incorporating highest quality stainless steel mounting base ensuring corrosion resistance.

The Shockwave TL.10 has been tested on a variety of mounting conditions as below specification, with excellent efficiency and gain measured in all typical common mounting conditions. Radiation patterns are consistent, and show very good stability in the azimuth on lower and upper bands.

Housing, frequency application, mounting type and connector are customizable, subject to minimum order quantities. Please contact your local Taoglas sales office for more information. The antenna also comes in White as standard.

2. Specification

ELECTRICAL							
Frequency (MHz)	698~800	824~960	1575.42	1710 ~ 1880	1850 ~ 1990	1920 ~ 2170	2400~2700
Peak Gain (dBi)							
Free Space	-1.7	-0.9	0.8	1.3	1.3	1.7	3.5
10x10cm GP center	-1.3	0.1	0.3	0.1	0.4	0.5	2.3
30x30cm GP center	2.7	2.5	1.0	2.2	2.1	2.2	3.1
50x50cm GP center	2.6	2.5	1.2	3.1	3.2	3.1	2.8
Average Gain (dBi)							
Free Space	-6.6	-5.1	-1.8	-1.5	-1.5	-1.3	-0.9
10x10cm GP center	-3.1	-1.9	-1.9	-2.1	-2.0	-1.9	-1.4
30x30cm GP center	-0.4	-1.1	-1.6	-1.7	-1.3	-1.3	-1.6
50x50cm GP center	-0.3	-1.0	-1.6	-1.2	-0.8	-0.9	-1.6
Efficiency							
Free Space	22%	31%	64%	69%	69%	72%	80%
10x10cm GP center	48%	63%	63%	60%	63%	63%	71%
30x30cm GP center	90%	76%	67%	67%	73%	73%	69%
50x50cm GP center	91%	78%	68%	75%	83%	81%	68%
Impedance	50Ω						
Polarization	Vertical						
Radiation Pattern	Omni						
Max. Input Power	5W						
MECHANICAL							
Casing	PC+PBT						
Connector	NMO						
Base	Stainless Steel						
Weight	180g						
ENVIRONMENTAL							
Temperature Range	-40°C to 85°C						
Humidity	Non-condensing 65°C 95% RH						

LTE BANDS			
Band Number	LTE / LTE-Advanced / WCDMA / HSPA / HSPA+ / TD-SCDMA		
	Uplink	Downlink	Covered
1	UL: 1920 to 1980	DL: 2110 to 2170	✓
2	UL: 1850 to 1910	DL: 1930 to 1990	✓
3	UL: 1710 to 1785	DL: 1805 to 1880	✓
4	UL: 1710 to 1755	DL: 2110 to 2155	✓
5	UL: 824 to 849	DL: 869 to 894	✓
7	UL: 2500 to 2570	DL: 2620 to 2690	✓
8	UL: 880 to 915	DL: 925 to 960	✓
9	UL: 1749.9 to 1784.9	DL: 1844.9 to 1879.9	✓
11	UL: 1427.9 to 1447.9	DL: 1475.9 to 1495.9	✓
12	UL: 699 to 716	DL: 729 to 746	✗
13	UL: 777 to 787	DL: 746 to 756	✗
14	UL: 788 to 798	DL: 758 to 768	✗
17	UL: 704 to 716	DL: 734 to 746 (LTE only)	✗
18	UL: 815 to 830	DL: 860 to 875 (LTE only)	✓
19	UL: 830 to 845	DL: 875 to 890	✓
20	UL: 832 to 862	DL: 791 to 821	✓
21	UL: 1447.9 to 1462.9	DL: 1495.9 to 1510.9	✓
22	UL: 3410 to 3490	DL: 3510 to 3590	✗
23	UL: 2000 to 2020	DL: 2180 to 2200 (LTE only)	✓
24	UL: 1625.5 to 1660.5	DL: 1525 to 1559 (LTE only)	✓
25	UL: 1850 to 1915	DL: 1930 to 1995	✓
26	UL: 814 to 849	DL: 859 to 894	✓
27	UL: 807 to 824	DL: 852 to 869 (LTE only)	✓
28	UL: 703 to 748	DL: 758 to 803 (LTE only)	✗
29	UL: -	DL: 717 to 728 (LTE only)	✗
30	UL: 2305 to 2315	DL: 2350 to 2360 (LTE only)	✓
31	UL: 452.5 to 457.5	DL: 462.5 to 467.5 (LTE only)	✗
32	UL: -	DL: 1452 - 1496	✓
35		1850 to 1910	✓
38		2570 to 2620	✓
39		1880 to 1920	✓
40		2300 to 2400	✓
41		2496 to 2690	✓
42		3400 to 3600	✗
43		3600 to 3800	✗

3. Antenna Characteristics

3.1 Return Loss

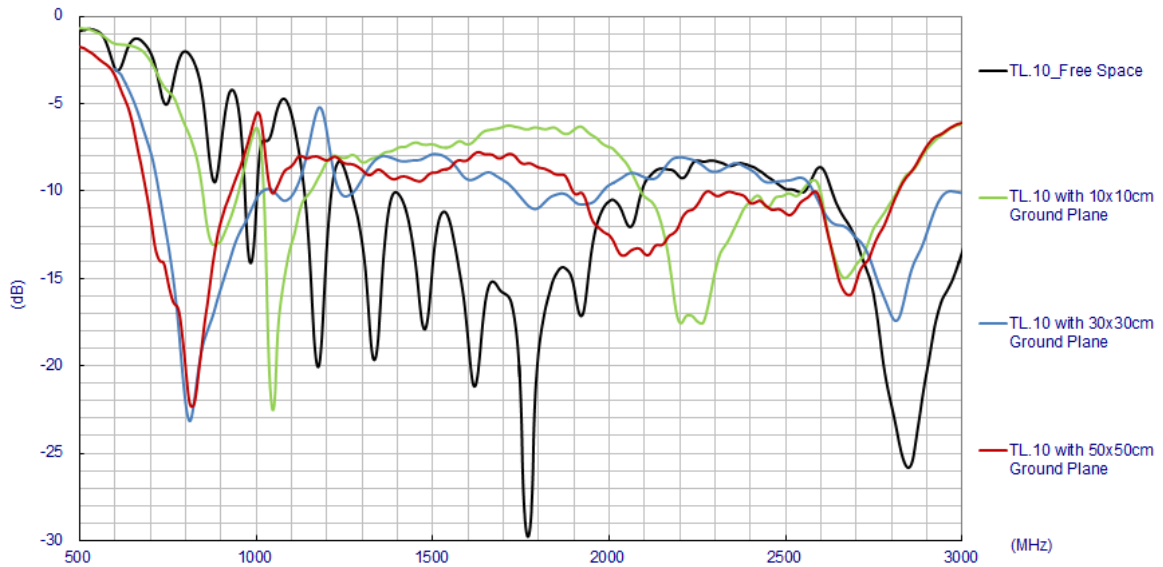

3.2 Maximum Gain

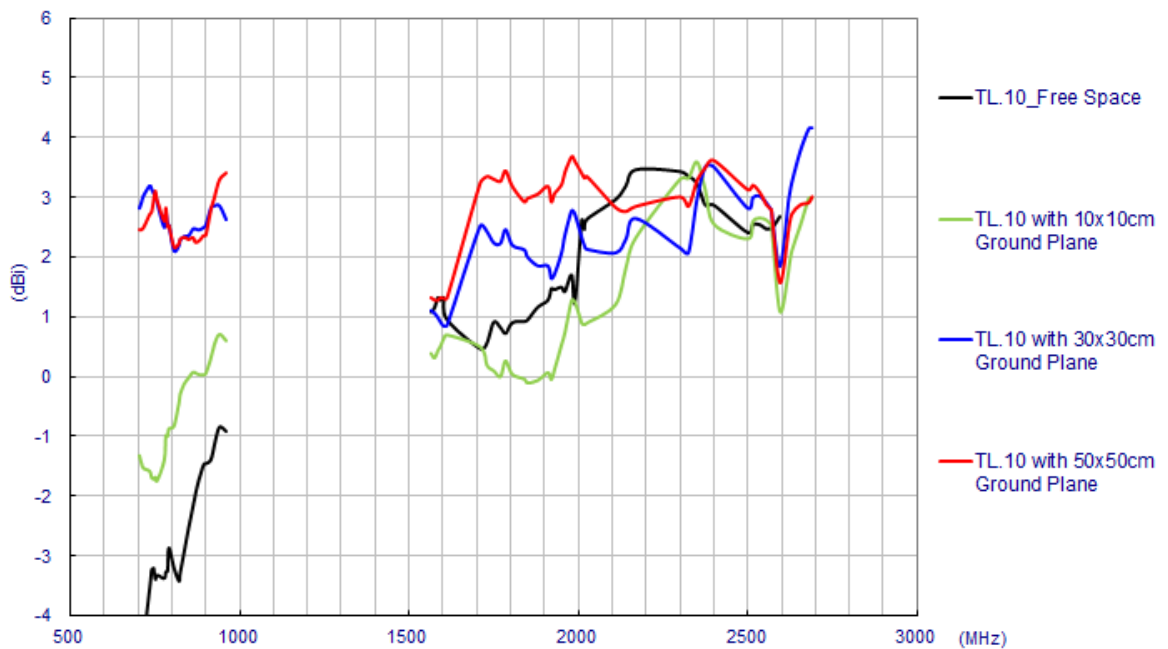

3.3 Average Gain

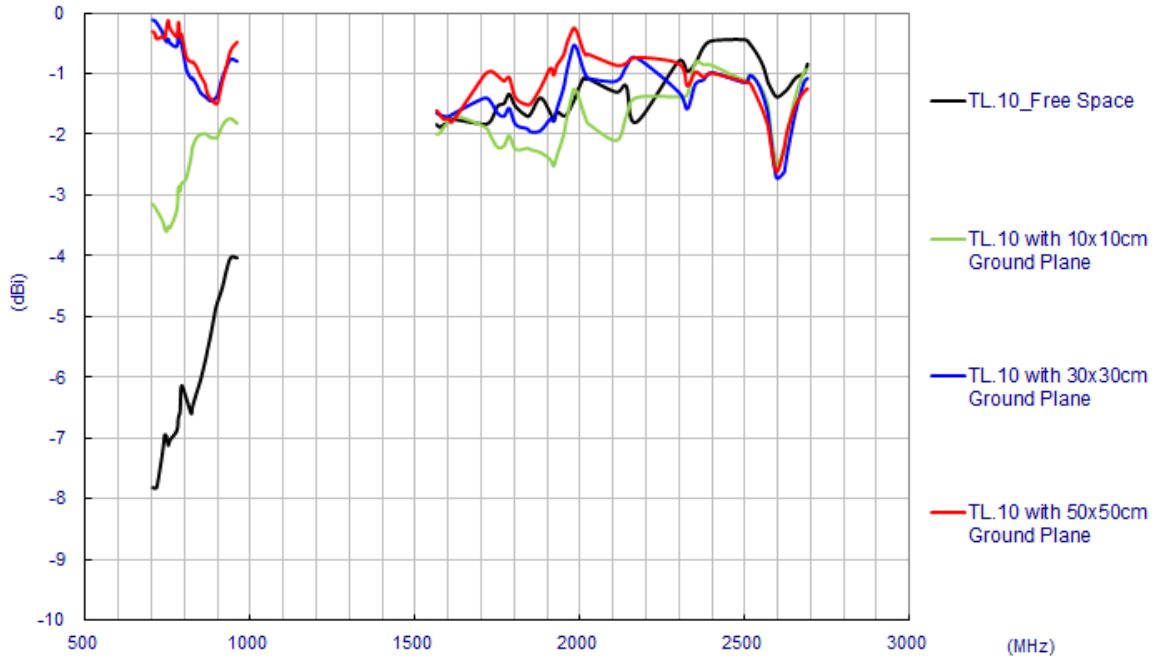

3.4 Efficiency

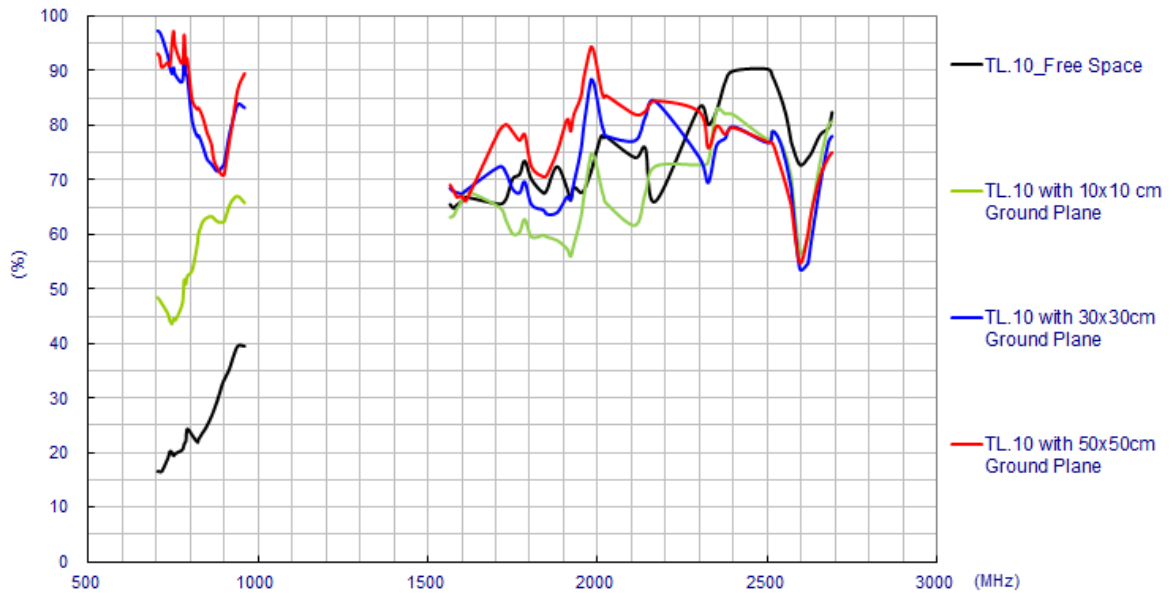

4. Antenna Radiation Patterns

4.1 Antenna setup (Free Space)

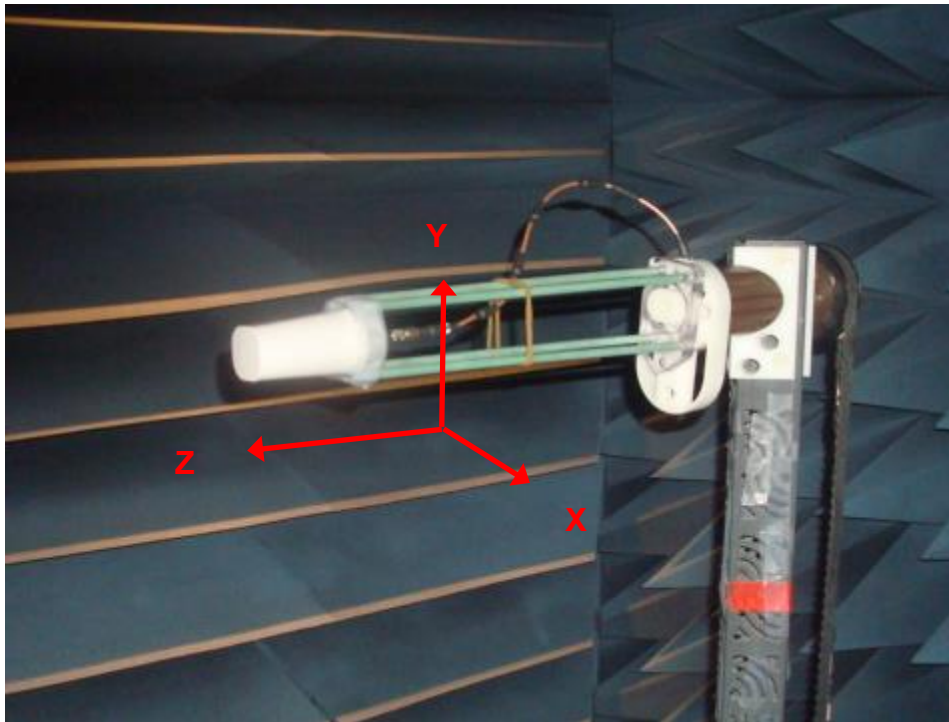

4.1.1 Radiation Patterns

XY Plane

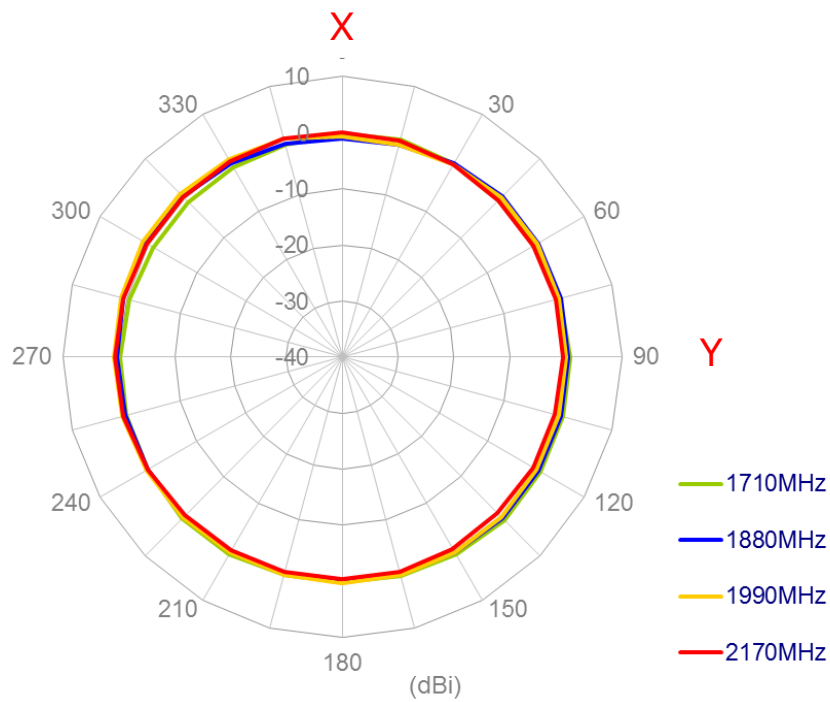
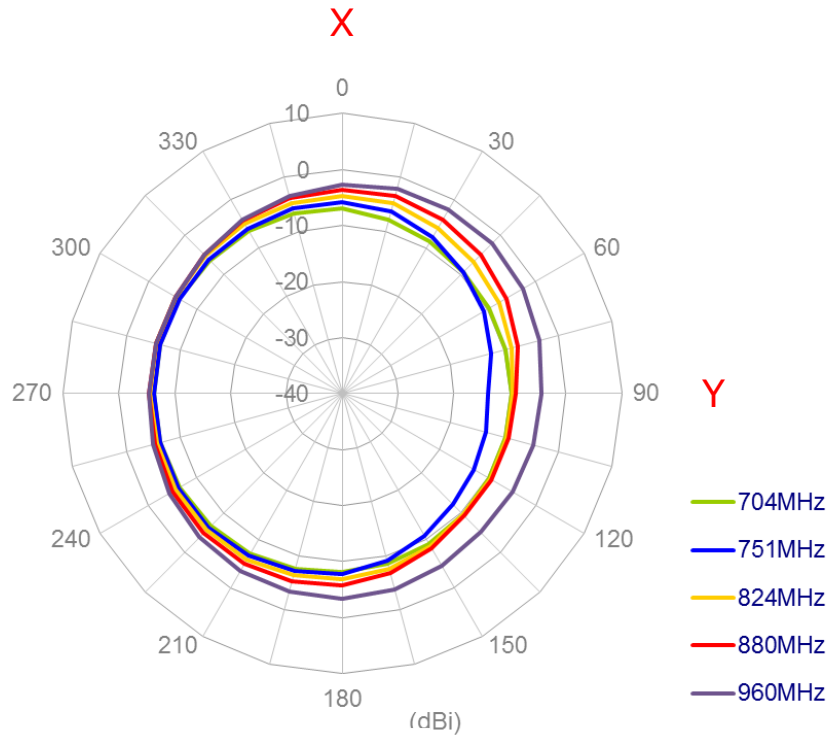

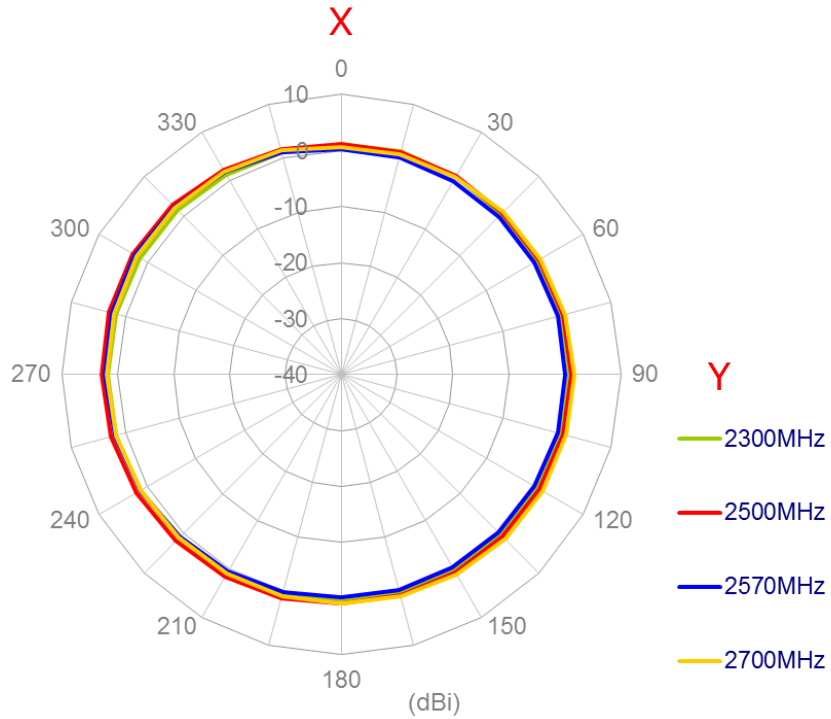

XZ Plane

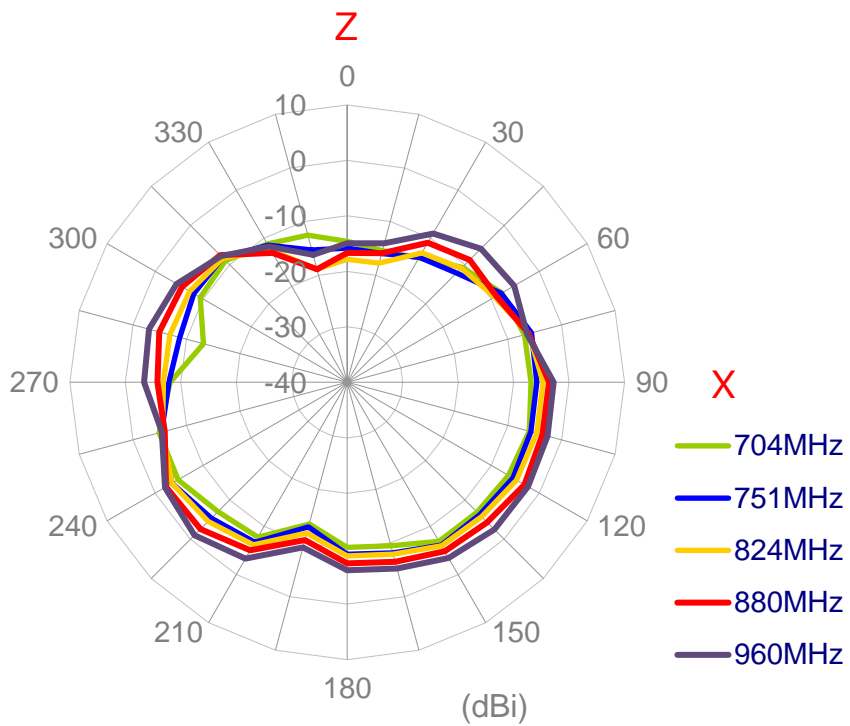

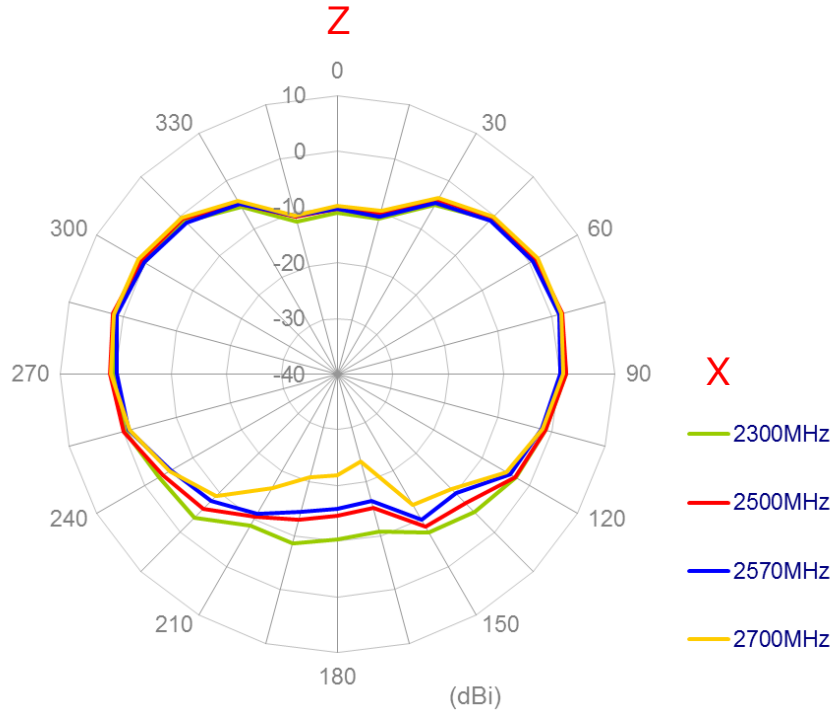
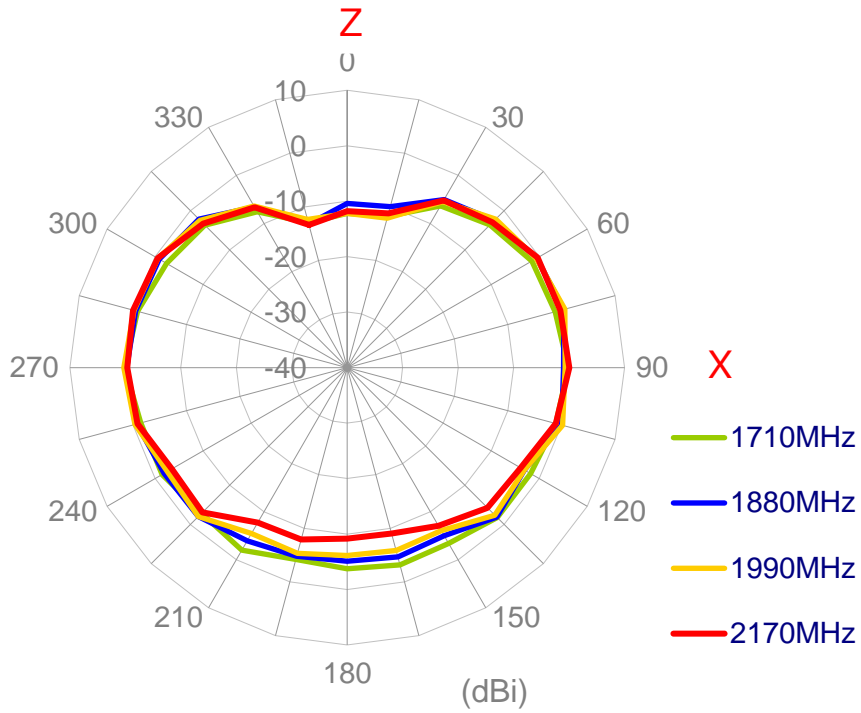

4.2 Antenna setup (10x10cm Metal Ground Plane)

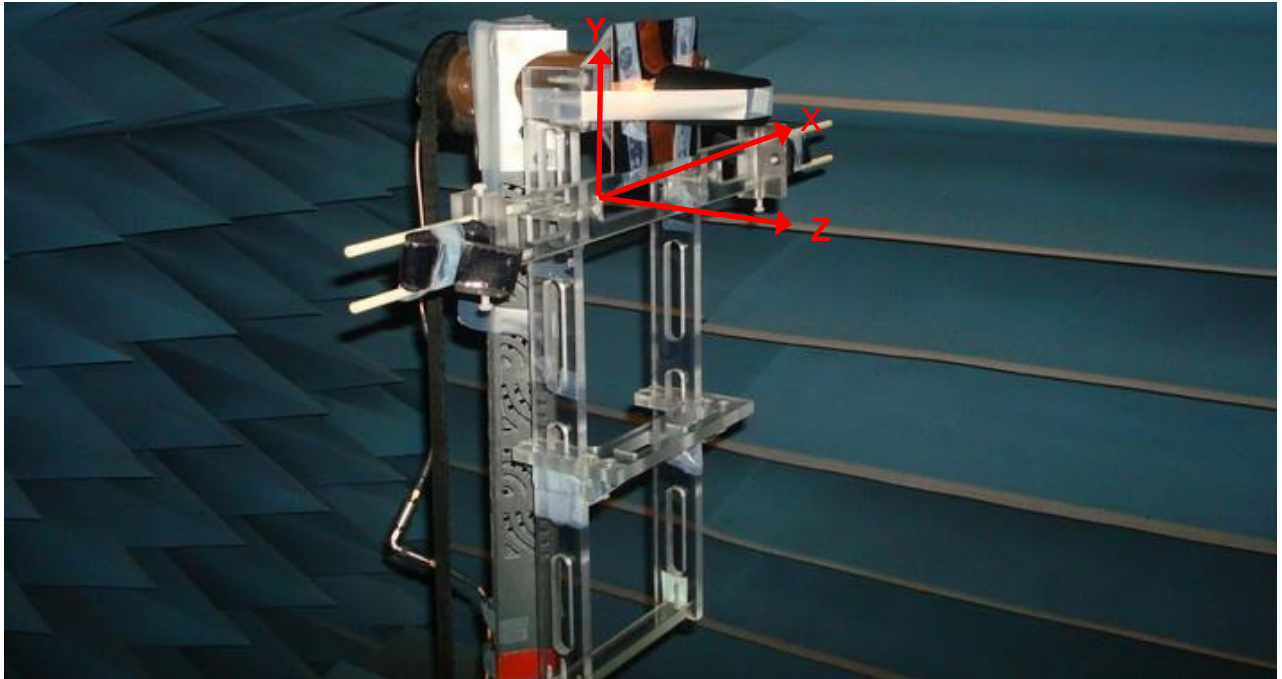

4.2.1 Radiation Patterns

XY Plane

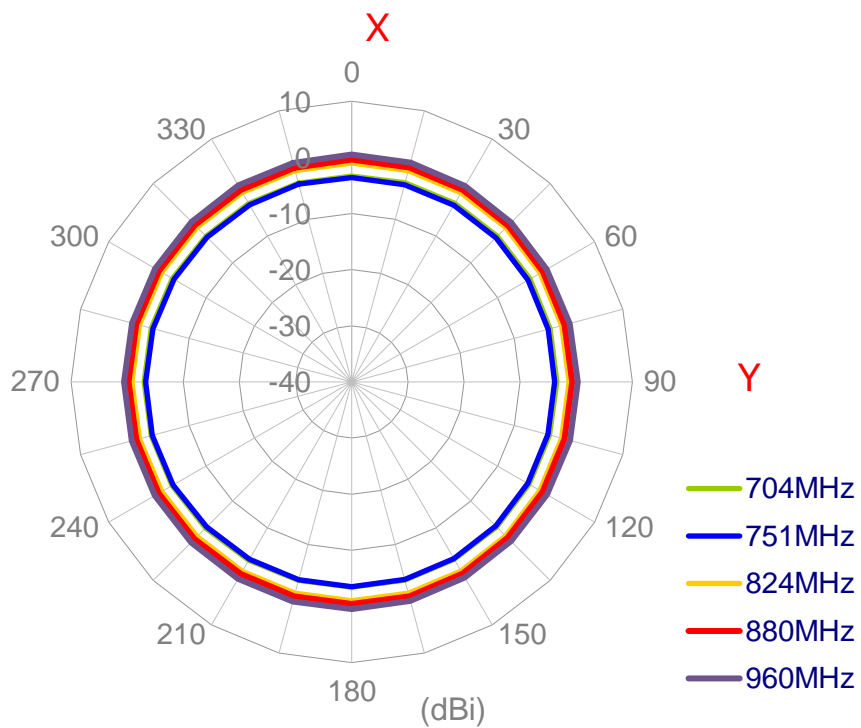

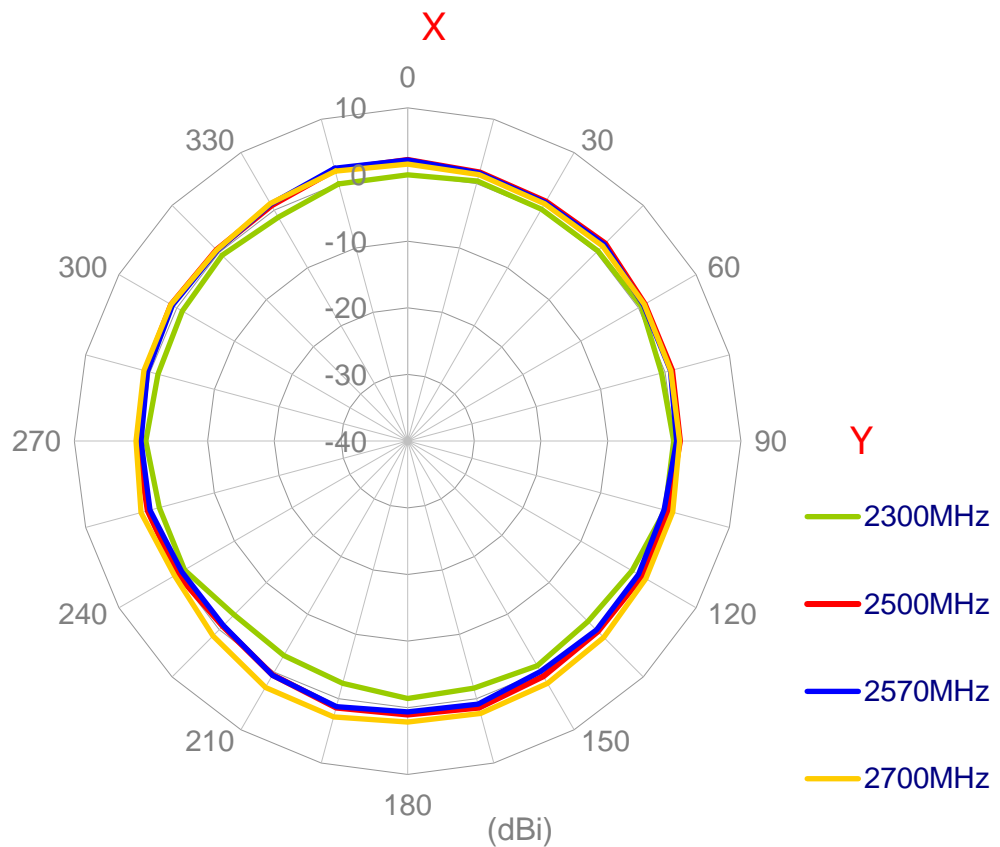
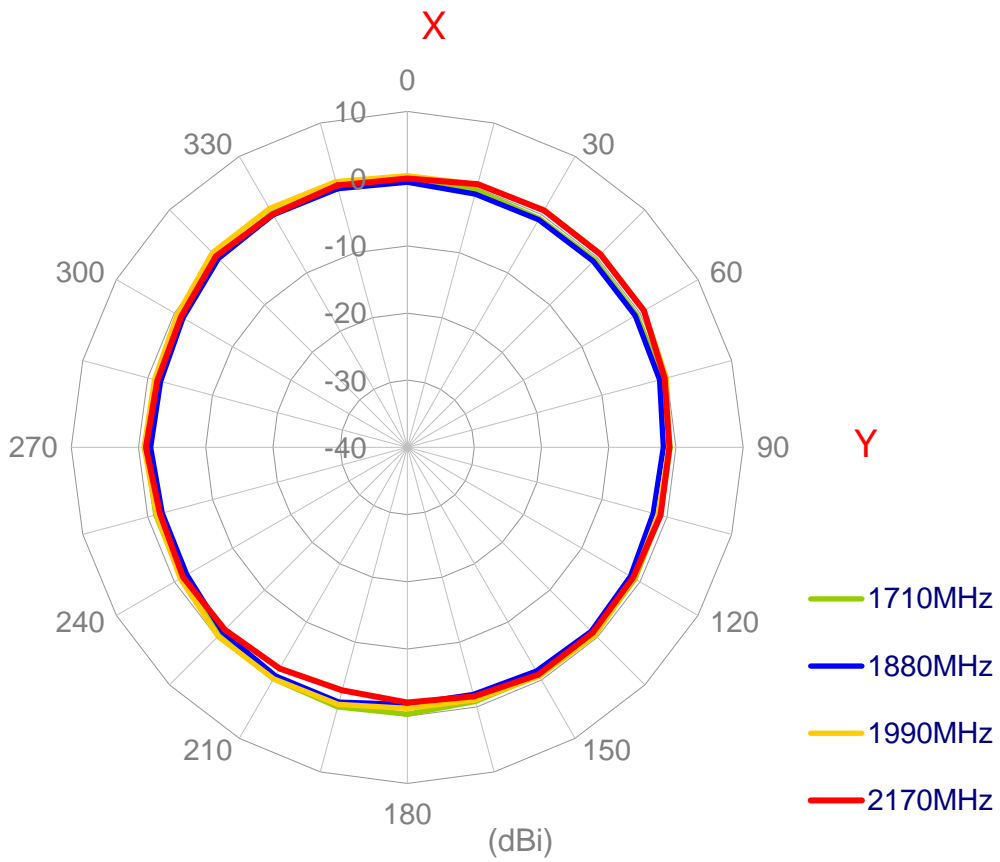

XZ Plane

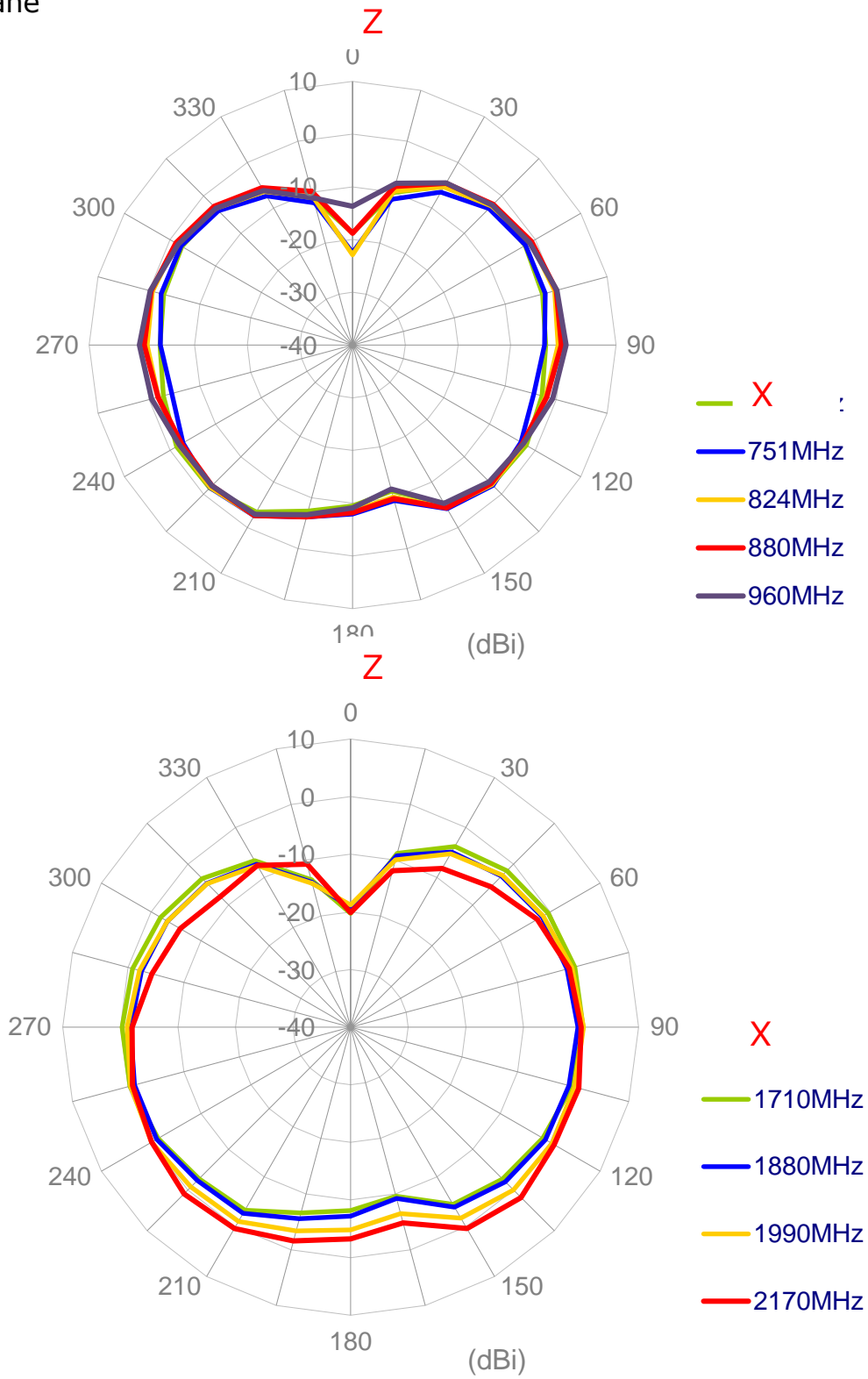

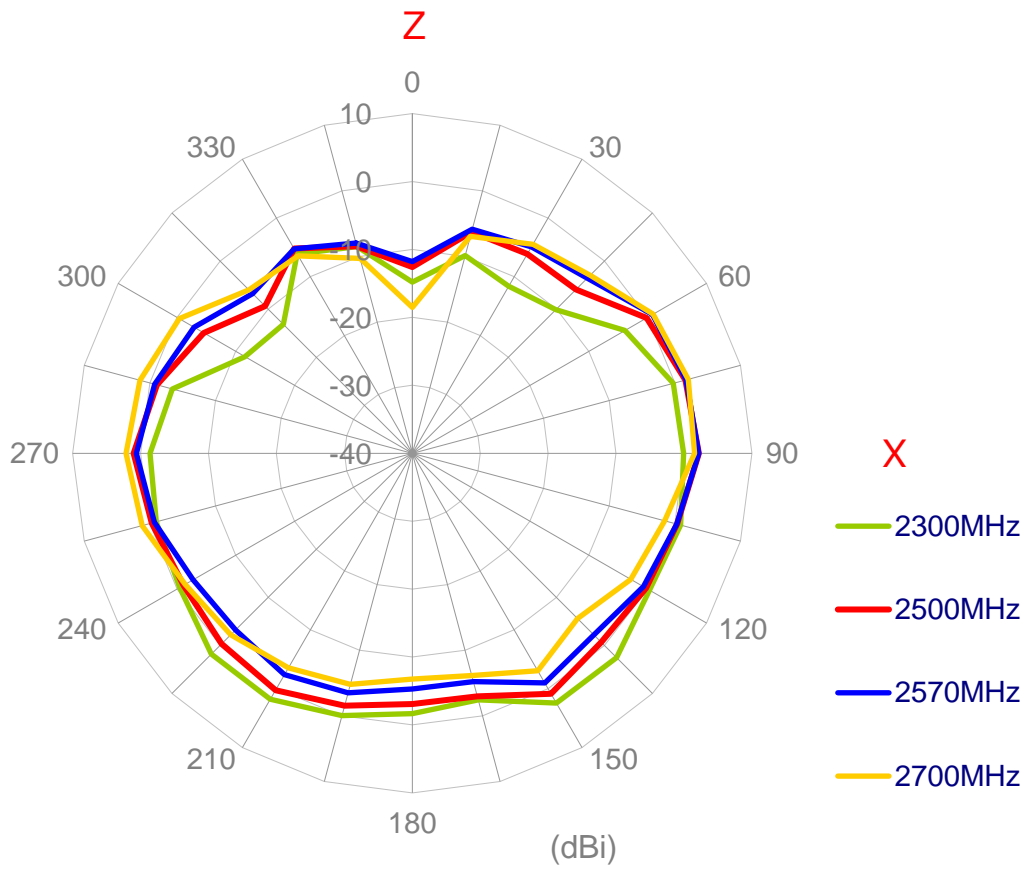

4.3 Antenna setup (30x30cm Metal Ground Plane)

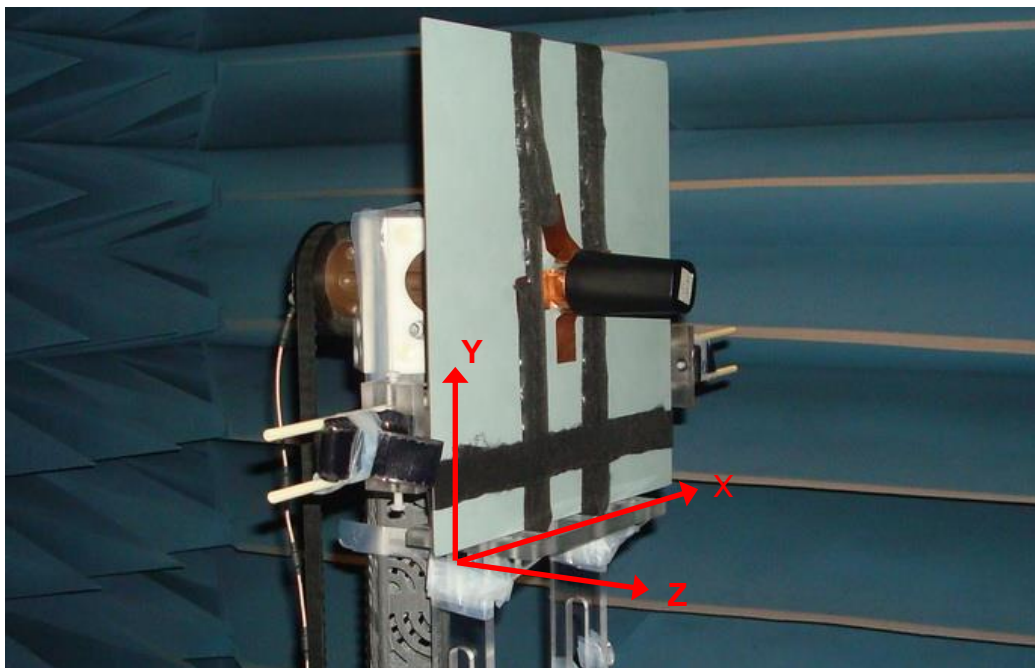

4.3.1 Radiation Patterns

XY Plane

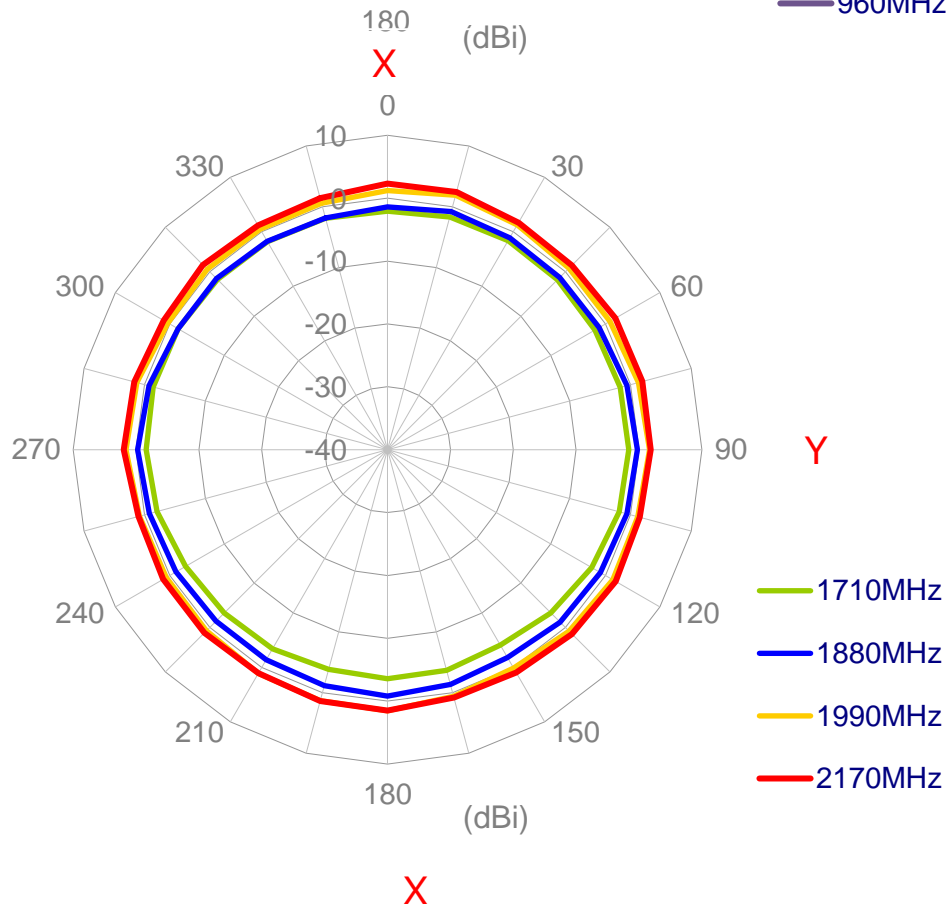
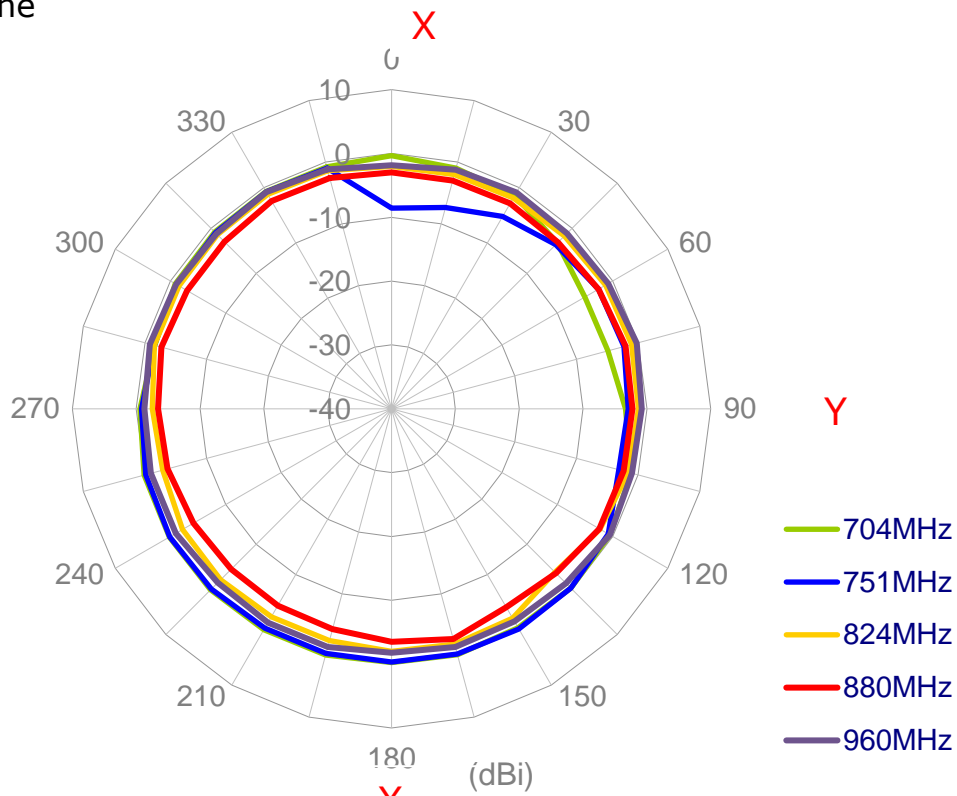

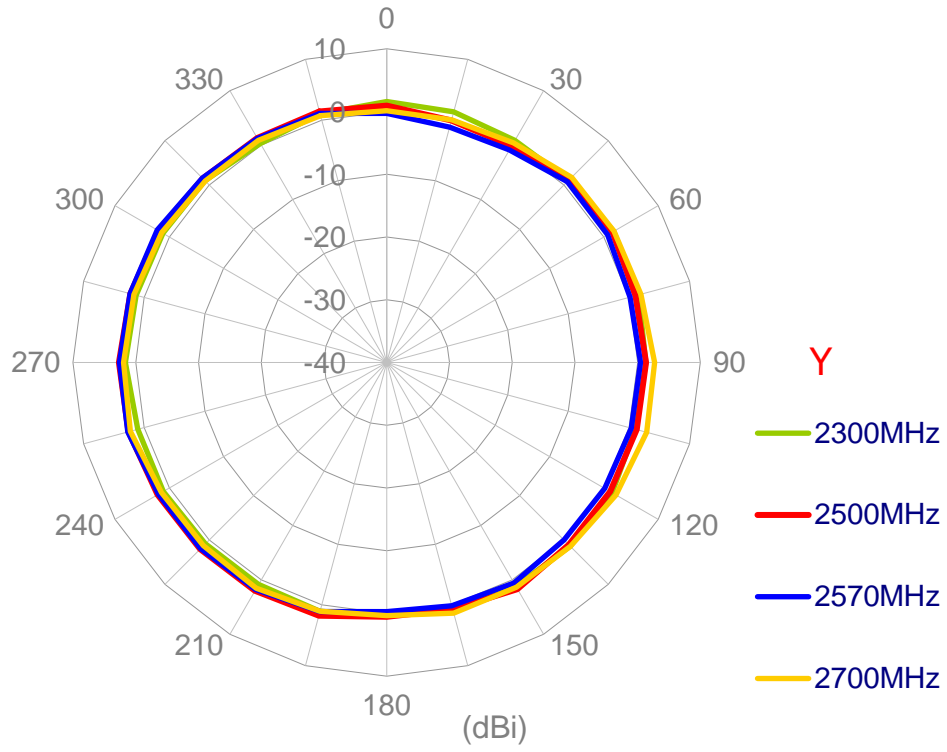

XZ Plane

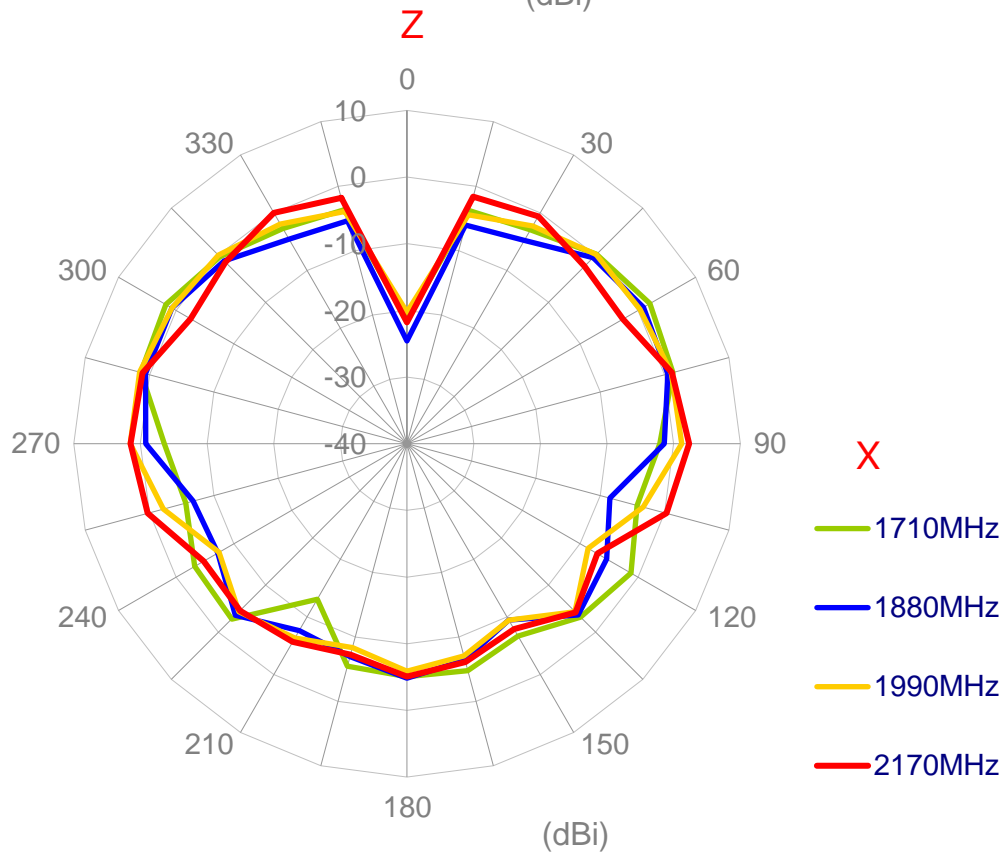
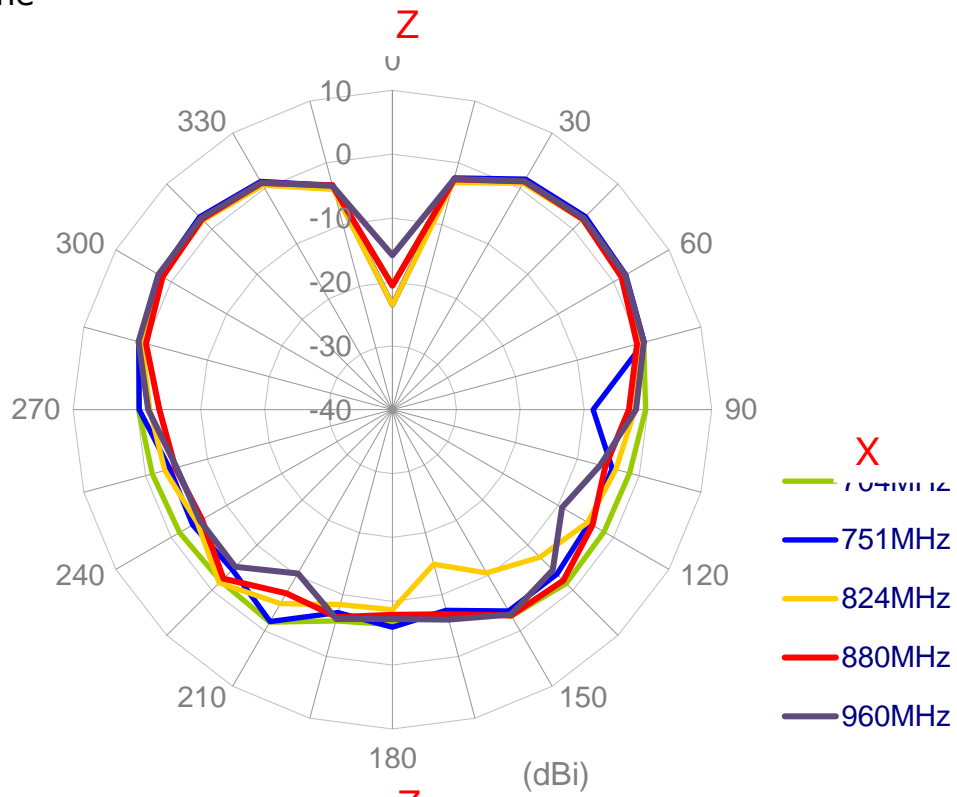

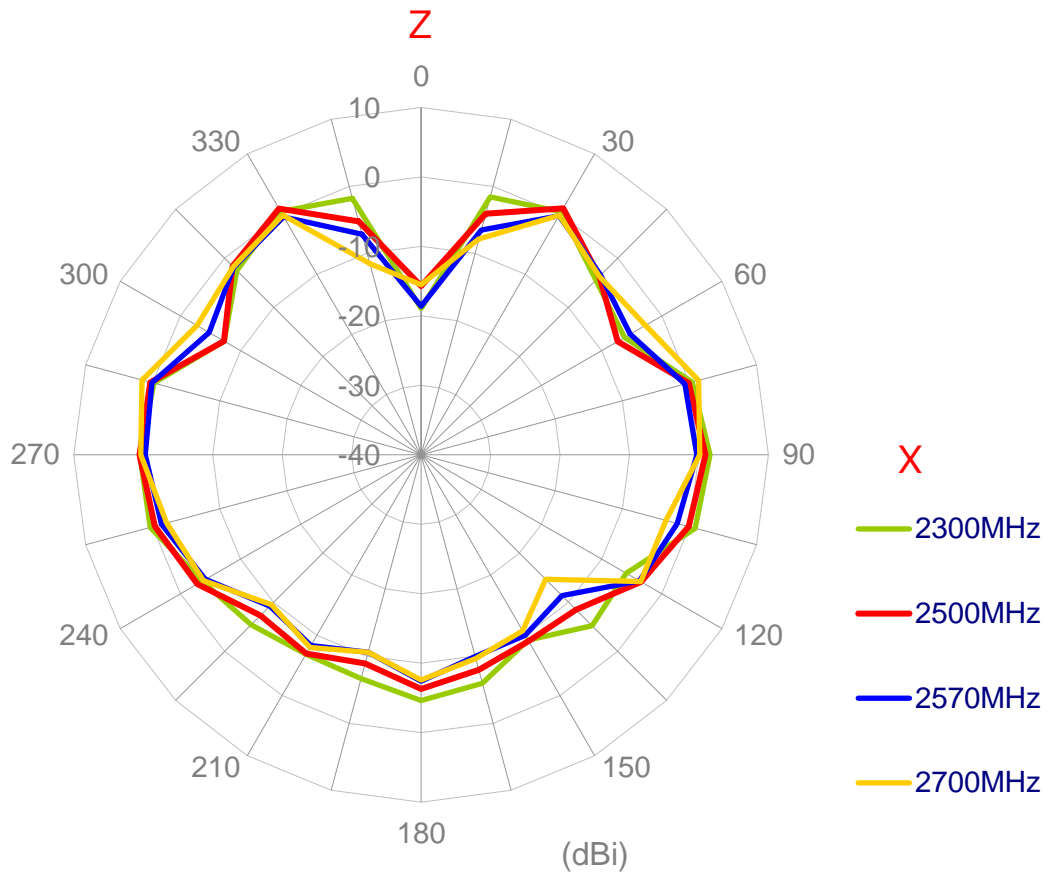

4.4 Antenna setup (50x50cm Metal Ground Plane)

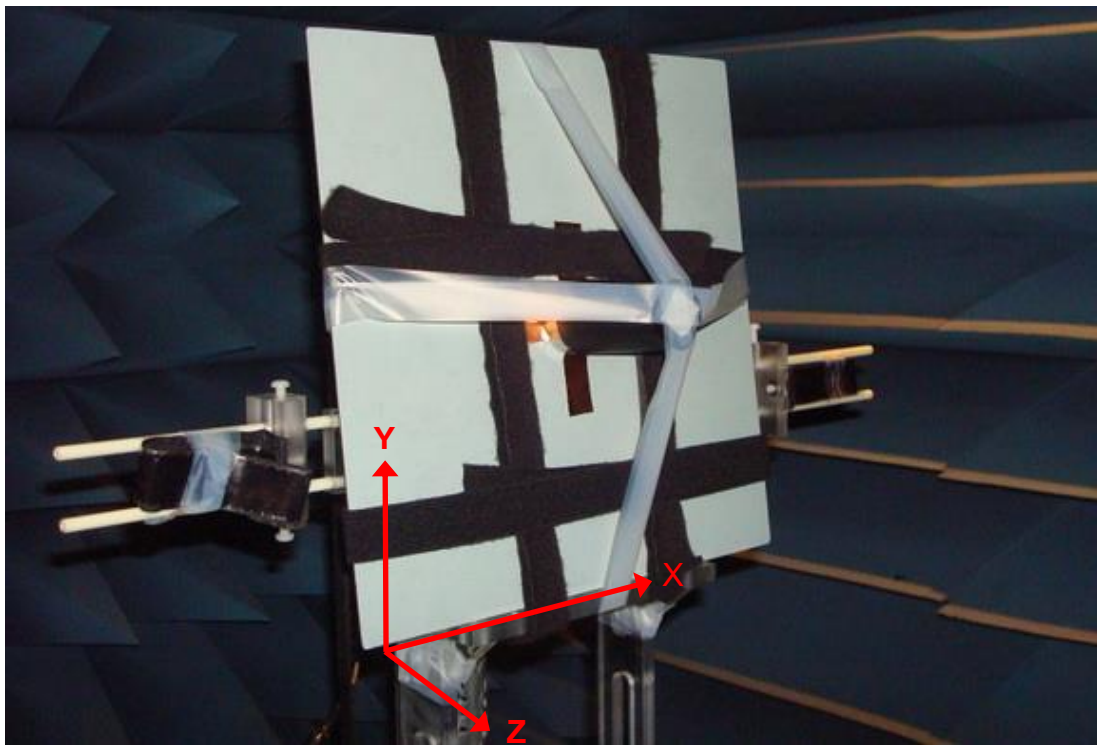

4.4.1 Radiation Patterns

XY Plane

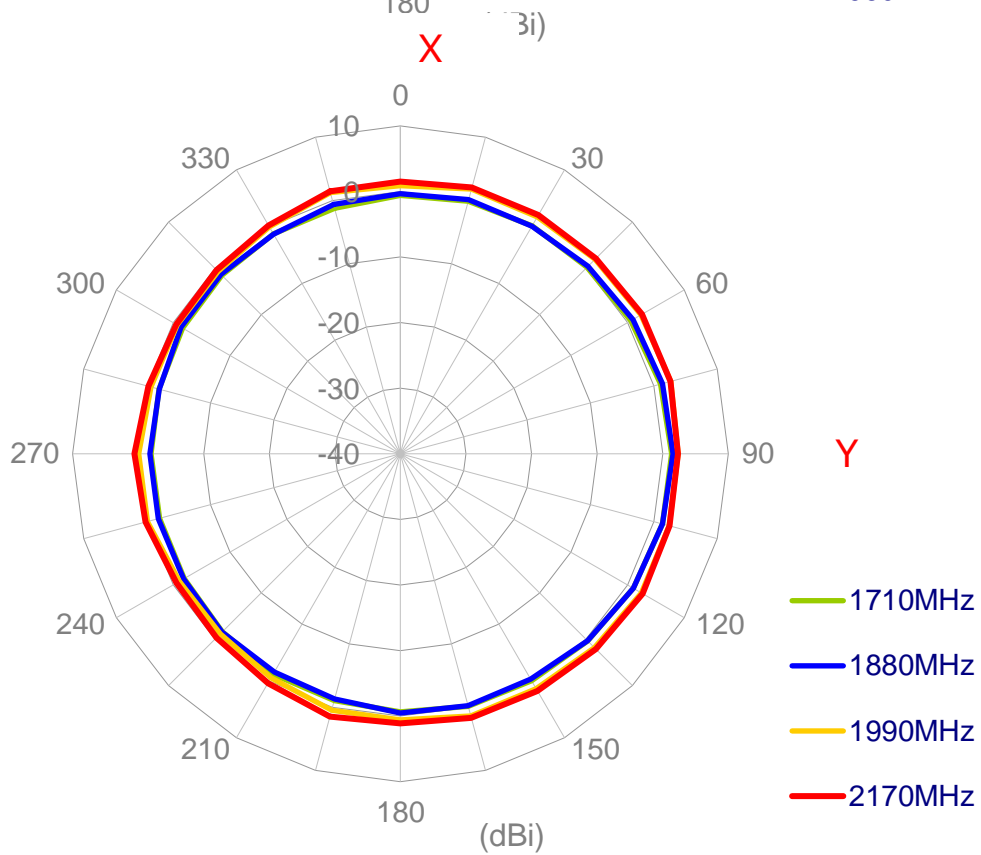
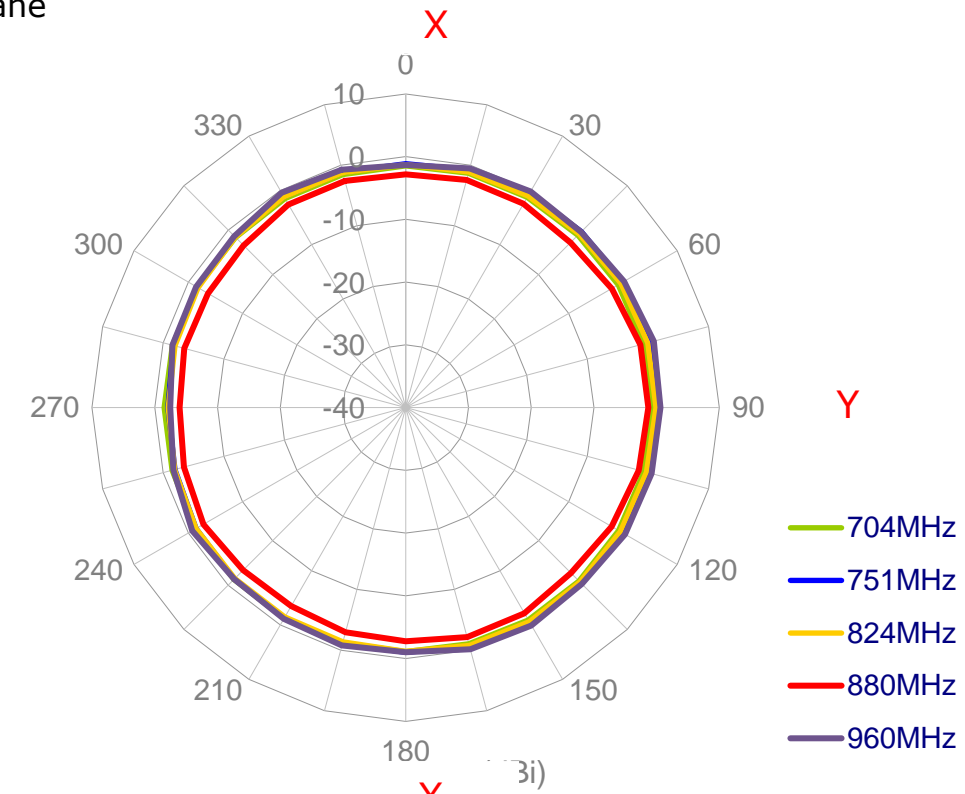

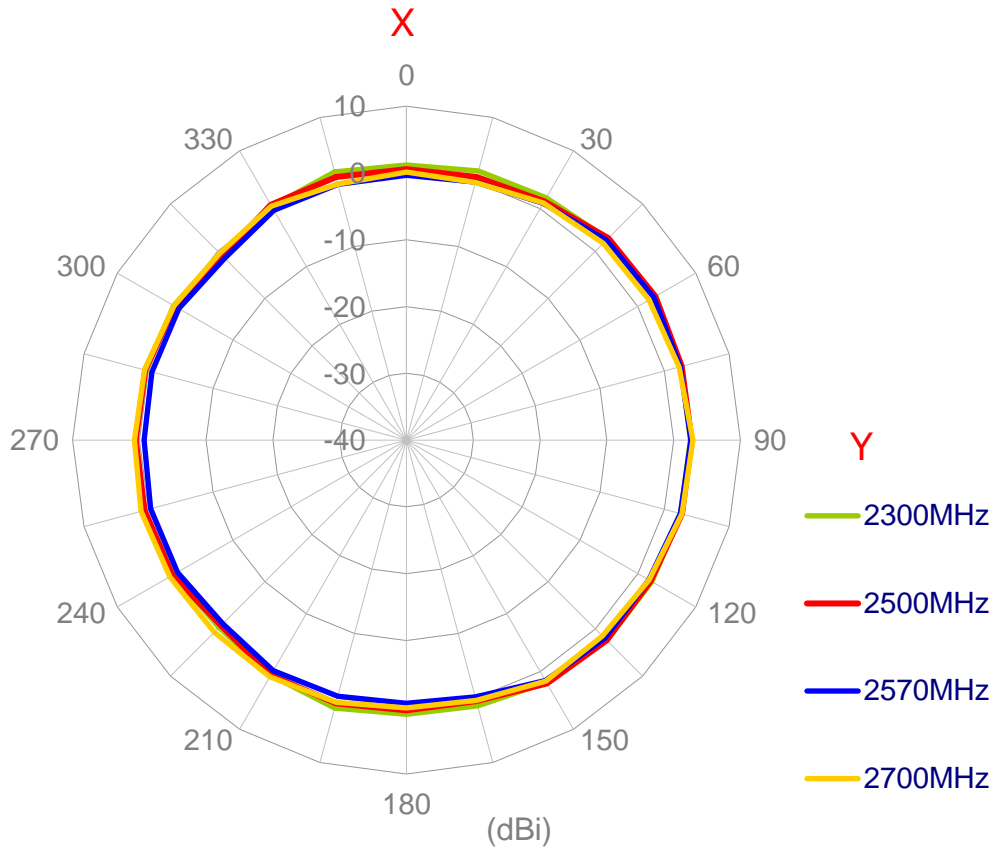

XZ Plane

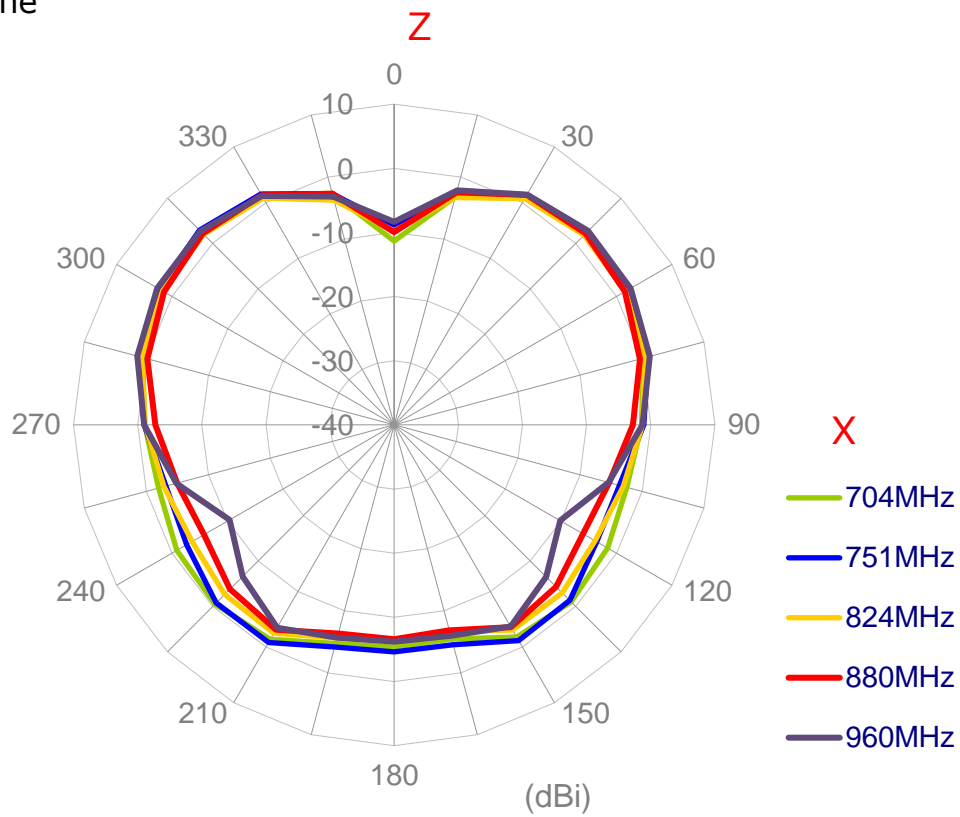

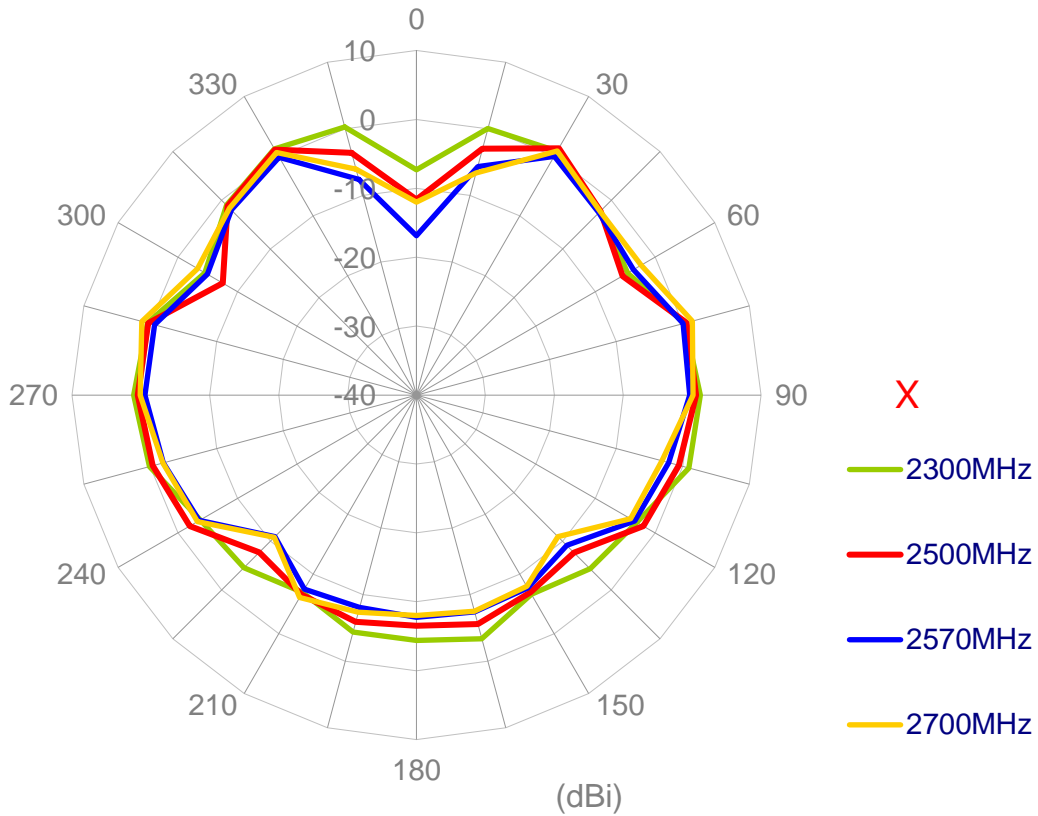
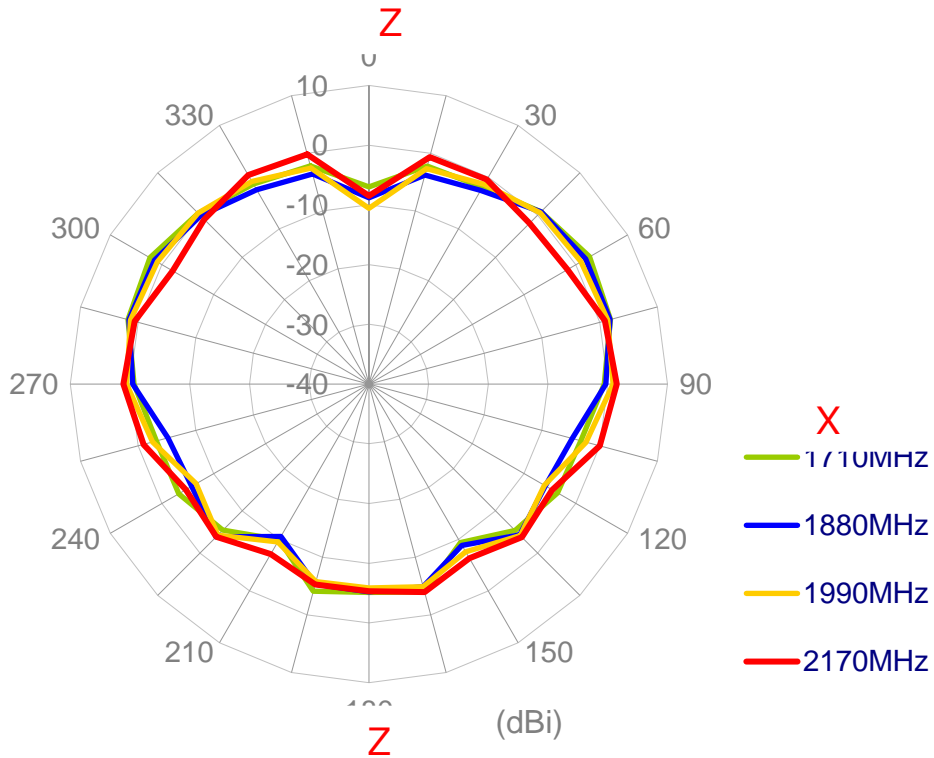

5. Mechanical Drawing (Unit: mm)

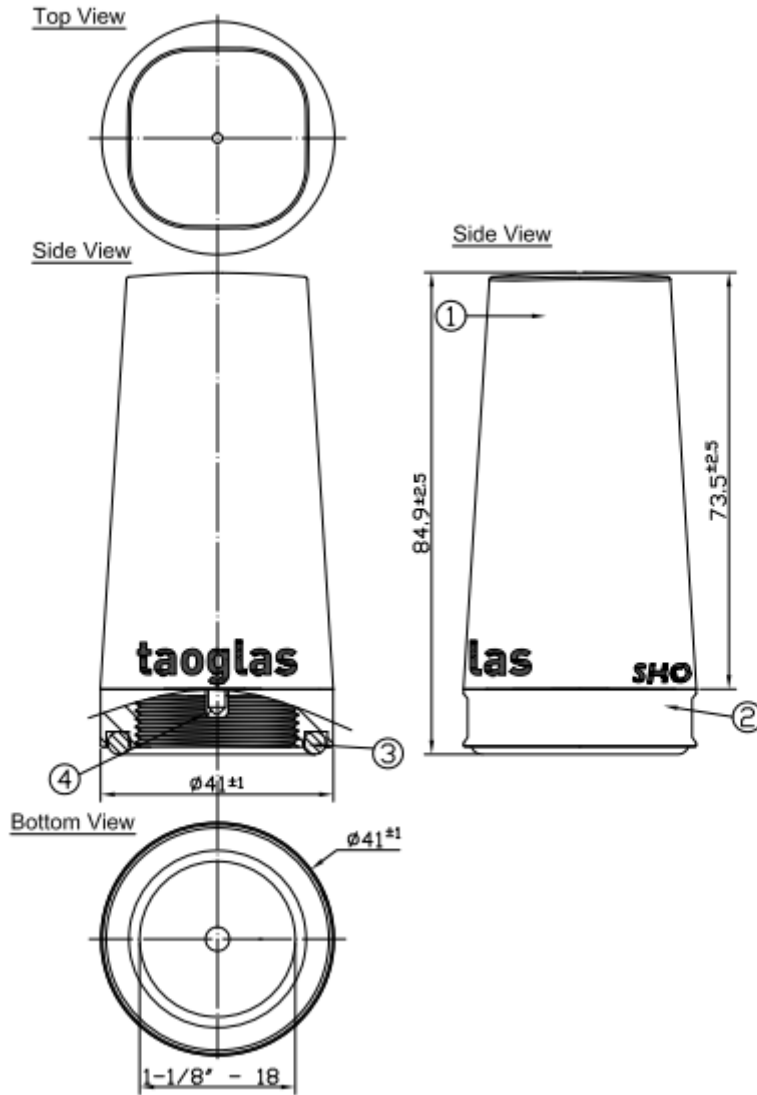

	Name	Material	Finish	Quantity
1	Antenna Top	PC + PBT	Black	1
2	Antenna Bottom (NMO Connector)	SUS	N/A	1
3	O-Ring	NBR	Red	1
4	PIN	Brass	Gold	1

6. Installation

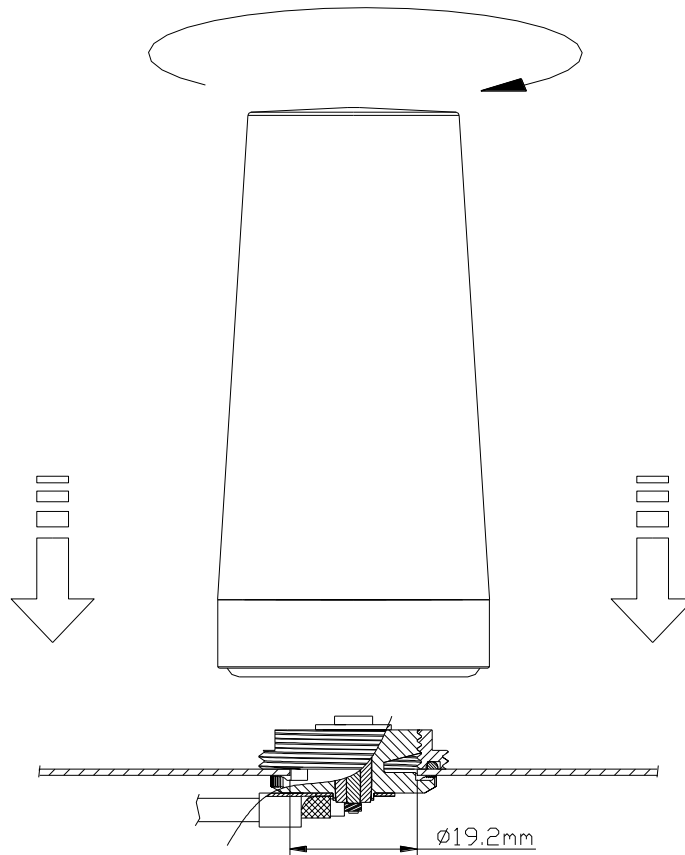

Recommended torque for mounting is 95Nm or 70ft lbs
Maximum torque for mounting is 135.6Nm or 100ft lbs

40mm wrench or 1-9/16" wrench can be used

7. Packaging

- 1 pcs antenna per PE bag
- 2 pcs EPE foam on top and bottom
- 1 pcs antenna per box

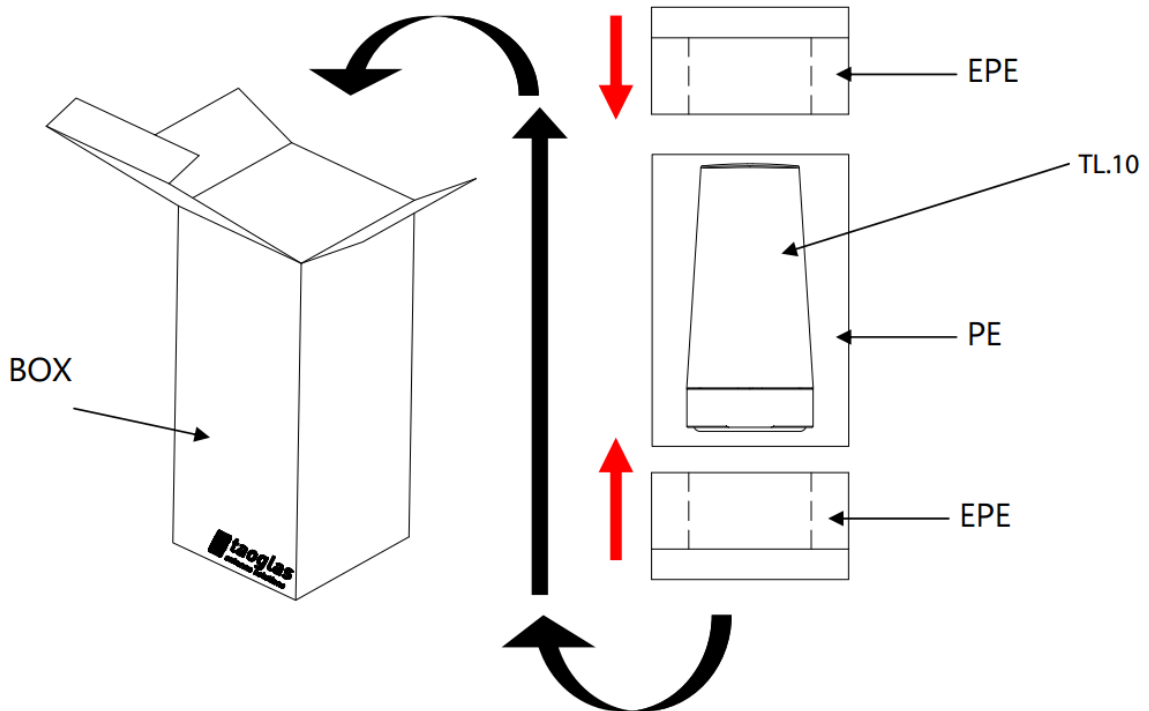

Taoglas makes no warranties based on the accuracy or completeness of the contents of this document and reserves the right to make changes to specifications and product descriptions at any time without notice. Taoglas reserves all rights to this document and the information contained herein.

Reproduction, use or disclosure to third parties without express permission is strictly prohibited.

Copyright © Taoglas Ltd.

X-ON Electronics

Largest Supplier of Electrical and Electronic Components

Click to view similar products for [Antennas](#) category:

Click to view products by [Taoglas](#) manufacturer:

Other Similar products are found below :

[GAN30084EU](#) [930-033-R](#) [GW17.07.0250E](#) [1513563-1](#) [EXE902SM](#) [APAMPG-117](#) [MAF94383](#) [W3908B0100](#) [W6102B0100](#) [YE572113-30RSMM](#) [108-00014-50](#) [66089-2406](#) [SPDA17RP918](#) [A09-F8NF-M](#) [A09-F5NF-M](#) [RGFRA1903041A1T](#) [W3593B0100](#) [W3921B0100](#) [SIMNA-868](#) [SIMNA-915](#) [SIMNA-433](#) [W1044](#) [W1049B090](#) [A75-001](#) [WTL2449CQ1-FRSMM](#) [CPL9C](#) [EXB148BN](#) [0600-00060](#) [TRA9020S3PBN-001](#) [Y4503](#) [GD5W-28P-NF](#) [MA9-7N](#) [GD53-25](#) [GD5W-21P-NF](#) [C37](#) [MAF94051](#) [MA9-5N](#) [EXD420PL](#) [B1322NR](#) [QWFTB120](#) [MAF94271](#) [MAF94300](#) [GPSMB301](#) [FG4403](#) [AO-AGSM-OM54](#) [5200232](#) [MIKROE-2349](#) [WCM.01.0111](#) [MIKROE-2393](#) [MIKROE-2352](#)