



TAOGLAS®



Datasheet

LAN Transformer 10/100Base-T Quad

Part No:
TM1234NL

Description

LAN 10/100 Base-T transformer
Quad Port and 40pin SMT

Features

CMC/Cable
AutoMDIX
Industrial grade
RoHS & REACH Compliant

1. Introduction	3
2. Specifications	4
3. Mechanical	5
4. Electrical	6
5. Packaging & Storage	7
<hr/>	
Changelog	8

Taoglas makes no warranties based on the accuracy or completeness of the contents of this document and reserves the right to make changes to specifications and product descriptions at any time without notice. Taoglas reserves all rights to this document and the information contained herein. Reproduction, use or disclosure to third parties without express permission is strictly prohibited.



1. Introduction



Featuring compatible footprint with industry LAN transformers and designed to work in industrial environmental conditions, the Taoglas TM1234NL is an LAN Transformer 10/100Base-T Quad Port of 40pin with Common Mode Choke on the cable side which makes it suitable of AutoMDIX feature.

Typical applications for this cost-effective part are:

- Industrial Automation
- Hubs
- Routers
- Switches
- Wireless Access Points

The Taoglas Magnetics Product Team have over fifteen years of LAN magnetics design and high-quality manufacturing. With an ever-expanding portfolio, we provide trusted products and services to customers within a wide range of applications such as: Networking and Interconnect Devices, Servers, Switches, Router, Communication systems and any Digital Consumer electronics.

The Taoglas Exos Series offer an extensive product line of LAN Transformers designed for commercial and industrial grade applications, supporting 10/100 Base-T (Exos100 Series), 1G Base-T (Exos1G Series) and 10G Base-T (Exos10G Series). These products include Single, Dual, and Quad configurations not only for standard applications but also for Power over Ethernet (PoE, PoE+, PoE++).

For more information on the range of products or for assistance with integration, contact your regional Taoglas customer support team.

2. Specifications

Electrical Performance @25°C	
Inductance OCL	350µH MIN @ 100KHz 0.1V 8mA DC Bias
Turns Ratio (±2%)	TX=1CT: 1CT RX=1CT: 1CT
DCR	1.2 Ω MAX
Insertion Loss	-1.4dB MAX @ 0.1-100Mhz
Return Loss	-18dB MIN @ 2-30Mhz
	-14.4dB MIN @ 30-40Mhz
	-13.1dB MIN @ 40-50Mhz
	-12dB MIN @ 50-80Mhz
Cross talk	-55dB MIN @ 0-0.1Mhz
	-45dB MIN @ 0.1-30Mhz
	-40dB MIN @ 30-60Mhz
	-33dB MIN @ 60-100Mhz
DCMR (dB MIN)	-37dB MIN @ 1-60Mhz
	-25dB MIN @ 60-200Mhz
Hipot	1500Vrms

Environmental Specifications	
Operating Temperature	-40°C TO +85°C

Compliance	
UL recognized - FILE NO. E528697	
RoHS Compliant	

Storage requirements	
Humidity	Storage Temperature
MSL - 1	-40°C TO +85°C

3. Mechanical

3.1 Mechanical Drawings

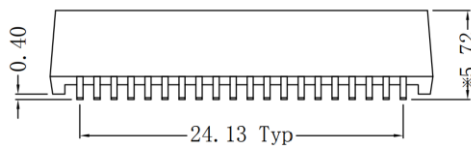

Front View

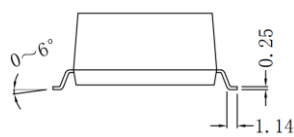

Left View

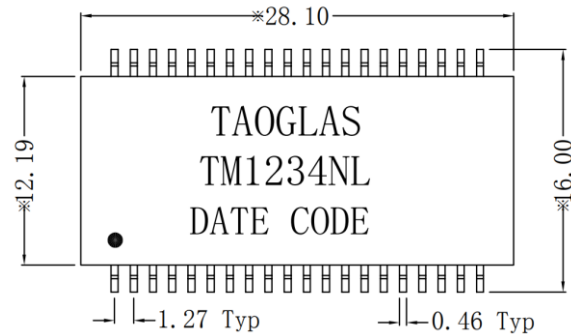

Top View

Mechanical Specifications

Length	28.10mm
Width	16.00mm
Height	5.72mm
Mounting Style	Surface Mount (SMT)

Dimensions are in millimeters with the following tolerances: X.XX = ± 0.25

3.2 Pad Layout

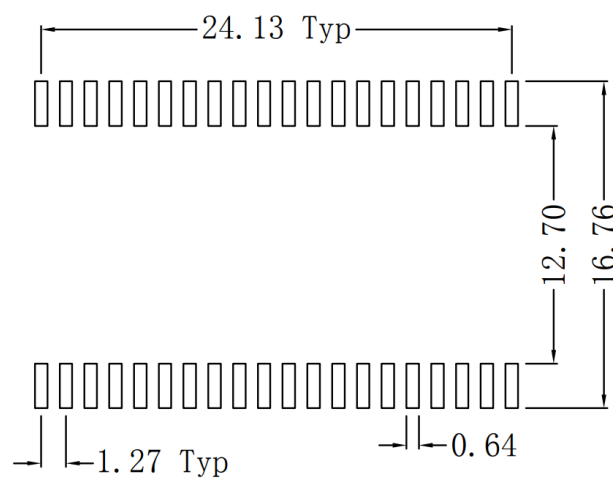

Suggested Pad Layout

Dimensions are in millimeters with the following tolerances: X.XX = ± 0.10

4. Electrical

4.1 Electrical Drawings

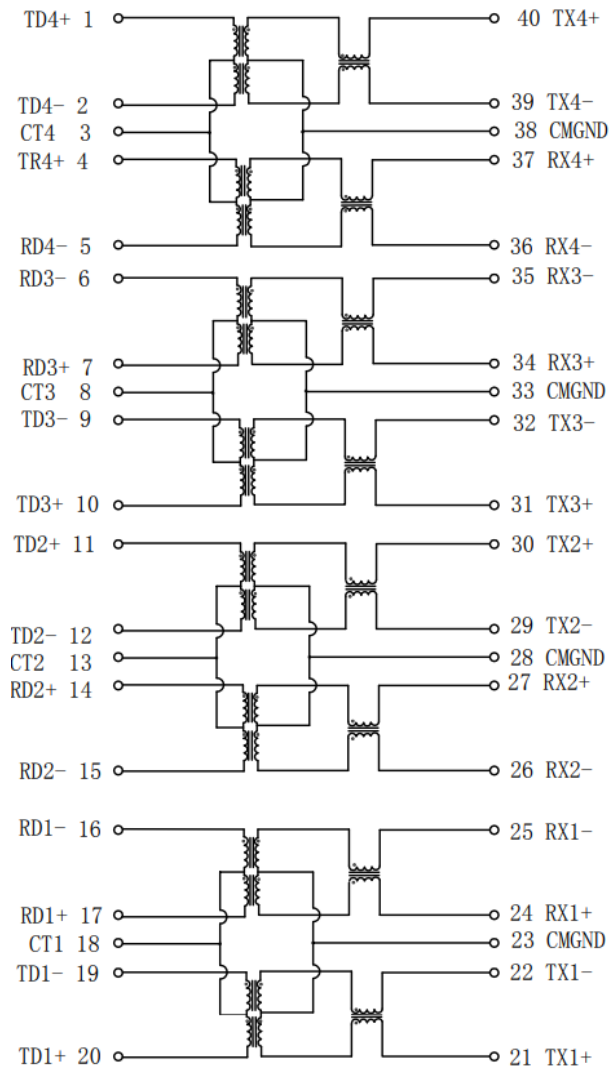

4.2 Profile of Reflow Solder

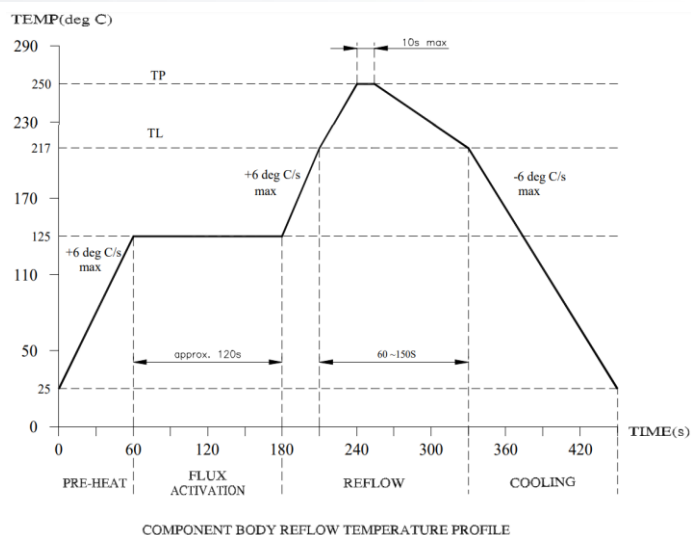

5. Packaging and Storage

5.1 SPQ

1200 pcs/reel

A (Carrier Tape Width): 44 ± 0.3 mm

B (Sprocket hole to Cavity center): 20.2 ± 0.2 mm

C (Cavity width): 16.6 ± 0.2 mm

Reel weight: 1150 g

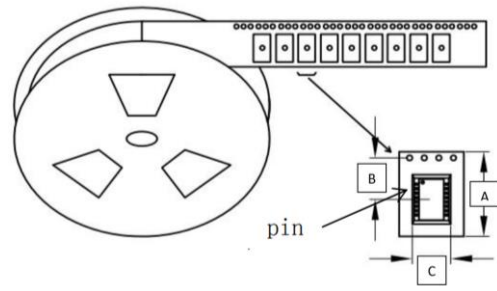

1CTN = 4 reels = 1600 pcs

Carton dimensions: 370*370*250mm

Carton Weight: 8 kg

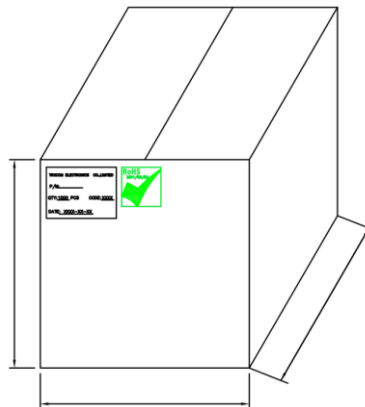

Changelog

Changelog for the datasheet

SPE-22-8-062 – TM1234NL

Revision: A (Original First Release)

Date:	2022-11-08
Notes:	
Author:	Javier Vasena

Previous Revisions



www.taoglas.com



X-ON Electronics

Largest Supplier of Electrical and Electronic Components

Click to view similar products for [Audio Transformers](#) / [Signal Transformers](#) category:

Click to view products by [Taoglas](#) manufacturer:

Other Similar products are found below :

[CU4S0506AT-2655-H1](#) [MGPWT-00449-P](#) [PE-64961](#) [1812WBT2-4](#) [BX1194WNL](#) [1879479-1](#) [PA1528ANL](#) [T1137NLT](#) [PE-65848FNLT](#)
[H5019EFNL](#) [CX2045ALNLT](#) [TG1G-E201NV6LF](#) [MGPWT-00059-P](#) [MGPWT-00266-P](#) [MGPWT-00278-P](#) [MGPWT-00431-P](#) [TTC-100](#)
[TTC-143-H](#) [TTC-5032-1](#) [4-1879391-0](#) [100213](#) [T1142NL](#) [TG1G-S001NZLF](#) [T1124NL](#) [1879732-1](#) [2-1879391-5](#) [MABA-010321-CT1A42](#)
[TX1341NL](#) [H0013FNL](#) [H5020FNL](#) [H2009FNLT](#) [H5004NLT](#) [S553-5999-52-F](#) [SCMS7D43AY100PT1](#) [T5008NLT](#) [PE-68517T](#) [MGPWT-](#)
[00339-P](#) [H5014FNLT](#) [TX1473NLT](#) [PE-69011NLT](#) [CX2043LNLT](#) [H7137FNLT](#) [H1259NLT](#) [TX1344NLT](#) [LM-LP-1005L](#) [H0013NLT](#)
[S558-5500-JV](#) [TX1193NLT](#) [T7015NL](#) [T1124NLT](#)