

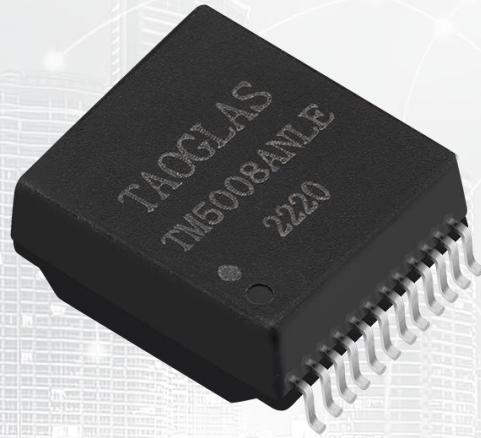

TAOGLAS®



Datasheet

LAN Transformer 1G Base-T

Part No:
TM5008ANLE

Description:

1000 Base-T/1G transformer
Single Port and 24pin SMT

Features:

Auto Transformer
Industrial grade
RoHS & REACH Compliant

| | |
|------------------------|---|
| 1. Introduction | 3 |
| 2. Specifications | 4 |
| 3. Mechanical | 5 |
| 4. Electrical | 6 |
| 5. Packaging & Storage | 7 |
| <hr/> | |
| Changelog | 8 |

Taoglas makes no warranties based on the accuracy or completeness of the contents of this document and reserves the right to make changes to specifications and product descriptions at any time without notice. Taoglas reserves all rights to this document and the information contained herein. Reproduction, use or disclosure to third parties without express permission is strictly prohibited.



1. Introduction

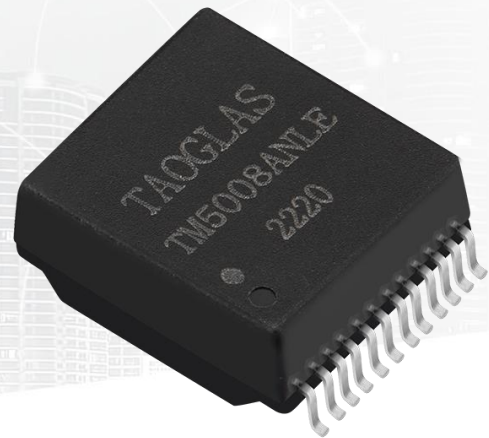

Featuring a compatible footprint with industry LAN transformers, and designed to work in demanding industrial environmental conditions, the Taoglas TM5008ANLE is an LAN Transformer 1GBase-T Single Port of 24 pin with Auto Transformer feature that will provide better EMI performance.

Typical applications for this cost-effective part are:

- Industrial Automation
- Hubs
- Routers
- Switches
- Wireless Access Points

The Taoglas Magnetics Product Team have over fifteen years of LAN magnetics design and high-quality manufacturing. With an ever-expanding portfolio, we provide trusted products and services to customers within a wide range of applications such as: Networking and Interconnect Devices, Servers, Switches, Router, Communication systems and any Digital Consumer electronics.

The Taoglas Exos Series offer an extensive product line of LAN Transformers designed for commercial and industrial grade applications, supporting 10/100 Base-T (Exos100 Series), 1G Base-T (Exos1G Series) and 10G Base-T (Exos10G Series). These products include Single, Dual, and Quad configurations not only for standard applications but also for Power over Ethernet (PoE, PoE+, PoE++).

For more information on the range of products or for assistance with integration, contact your regional Taoglas customer support team

2. Specifications

| Electrical Performance @25°C | |
|------------------------------|-------------------------------------|
| Inductance OCL | 350µH MIN @ 100KHz 0.1V 8mA DC Bias |
| Turns Ratio (±2%) | TX=1CT: 1CT RX=1CT: 1CT |
| Insertion Loss | -1dB MAX @ 1-100Mhz |
| Return Loss | -18dB MIN @ 1-30Mhz |
| | -18dB MIN @ 40Mhz |
| | -16dB MIN @ 50Mhz |
| | -12dB MIN @ 60-80Mhz |
| | -10dB MIN @ 100Mhz |
| Cross talk | -45dB MIN @ 30Mhz |
| | -40dB MIN @ 60Mhz |
| | -33dB MIN @ 100Mhz |
| DCMR (dB MIN) | -43dB MIN @ 30Mhz |
| | -37dB MIN @ 60Mhz |
| | -33dB MIN @ 100Mhz |
| Hi-Pot | 1500Vrms MIN |

| Environmental Specifications | |
|------------------------------|----------------|
| Operating Temperature | -40°C TO +85°C |

| Compliance | |
|----------------------------------|--|
| UL recognized - FILE NO. E528697 | |
| RoHS Compliant | |

| Storage requirements | |
|----------------------|---------------------|
| Humidity | Storage Temperature |
| MSL - 1 | -40°C TO +85°C |

3. Mechanical

3.1 Mechanical Drawings

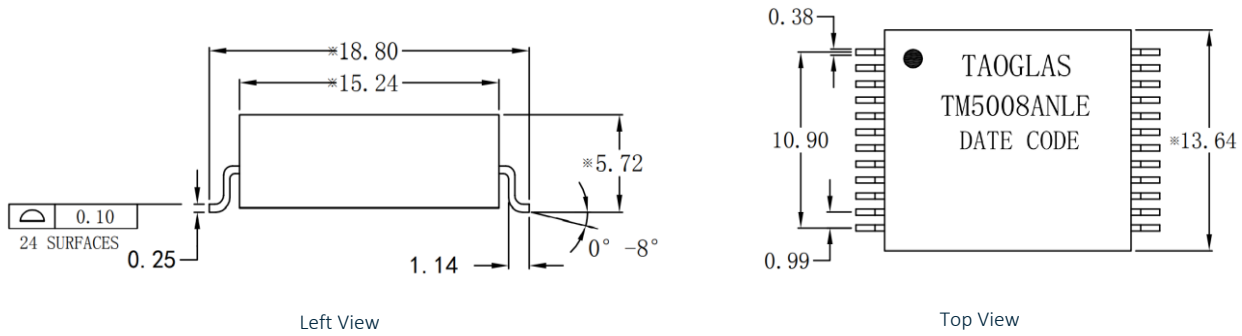

| Mechanical Specifications | |
|---------------------------|---------------------|
| Length | 13.64 mm |
| Width | 18.80 mm |
| Height | 5.72 mm |
| Mounting Style | Surface Mount (SMT) |

Dimensions are in millimeters with the following tolerances: X.XX = ±0.25

3.2 Pad Layout

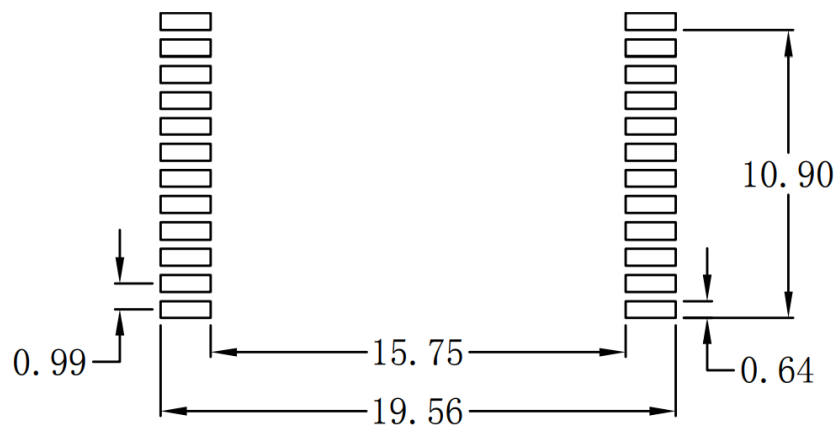

Suggested Pad Layout

Dimensions are in millimeters with the following tolerances: X.XX = ±0.10

4. Electrical

4.1 Electrical Drawings

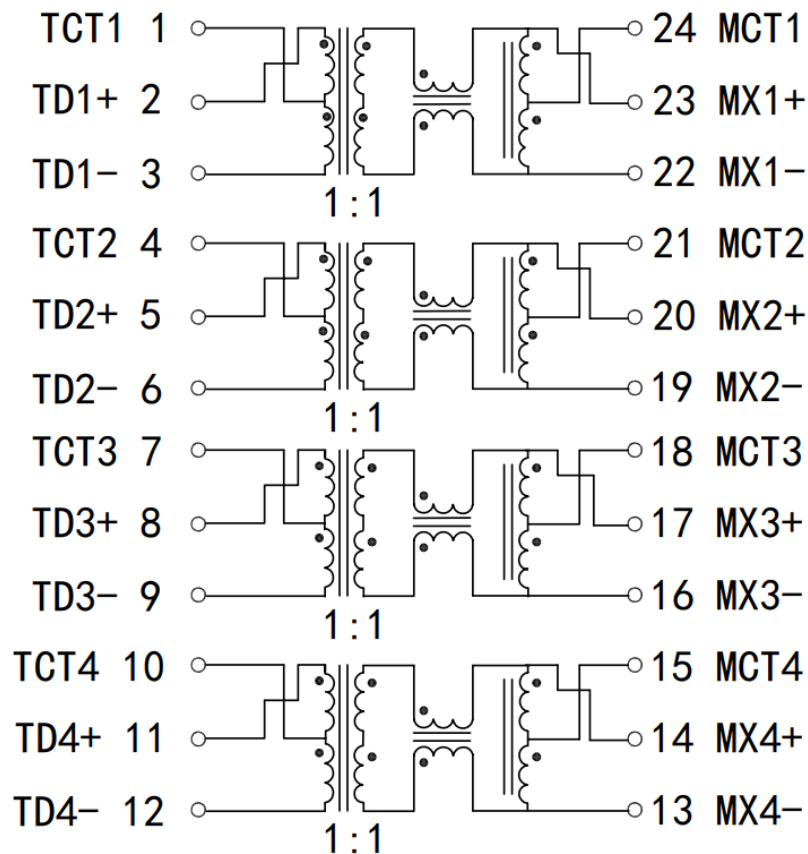

4.2 Profile of Reflow Solder

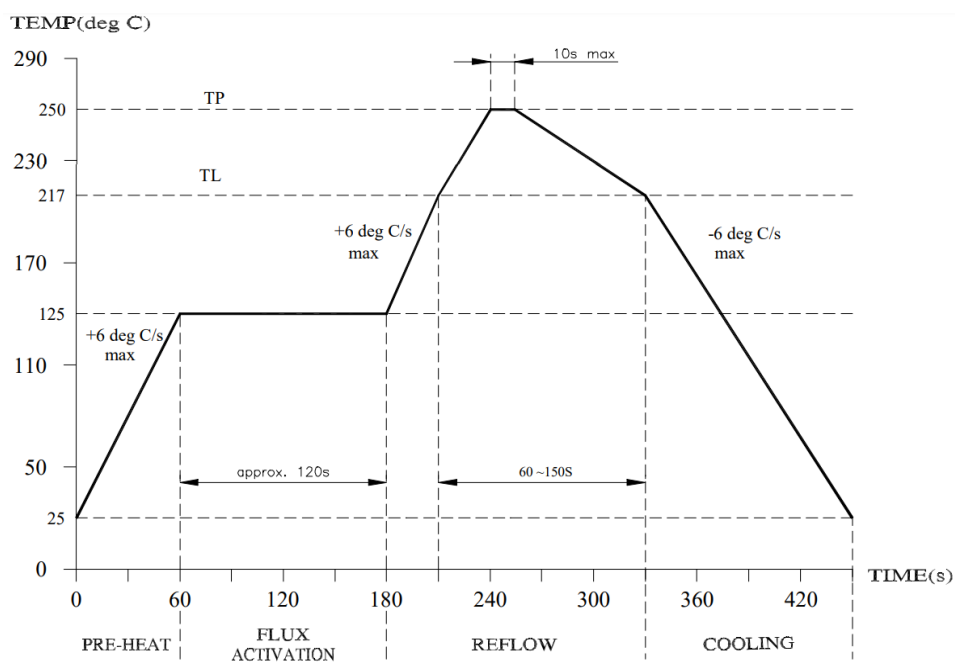

5. Packaging and Storage

5.1 SPQ

350 pcs/reel

A (Carrier Tape Width): 24 ± 0.3 mm

B (Sprocket hole to Cavity center): 11.5 ± 0.2 mm

C (Cavity width): 19.2 ± 0.2 mm

Reel weight: 850g

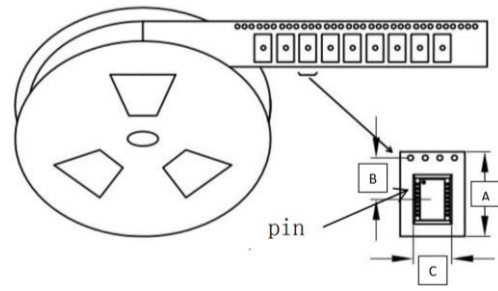

1CTN = 6 reels = 2100 pcs

Carton dimensions: 370*370*250mm

Carton Weight: 7kg

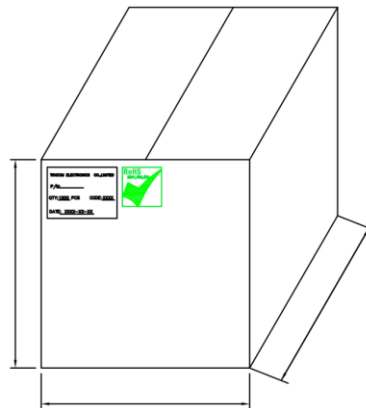

Changelog

Changelog for the datasheet

SPE-22-8-063 – TM5008ANLE

Revision: A (Original First Release)

| | |
|---------|---------------|
| Date: | 2022-11-08 |
| Notes: | |
| Author: | Javier Vasena |

Previous Revisions

| | |
|--|--|
| | |
| | |



www.taoglas.com



X-ON Electronics

Largest Supplier of Electrical and Electronic Components

Click to view similar products for [Audio Transformers](#) / [Signal Transformers](#) category:

Click to view products by [Taoglas](#) manufacturer:

Other Similar products are found below :

[CU4S0506AT-2655-H1](#) [MGPWT-00449-P](#) [PE-64961](#) [1812WBT2-4](#) [BX1194WNL](#) [1879479-1](#) [PA1528ANL](#) [T1137NLT](#) [PE-65848FNLT](#)
[H5019EFNL](#) [CX2045ALNLT](#) [TG1G-E201NV6LF](#) [MGPWT-00059-P](#) [MGPWT-00266-P](#) [MGPWT-00278-P](#) [MGPWT-00431-P](#) [TTC-100](#)
[TTC-143-H](#) [TTC-5032-1](#) [4-1879391-0](#) [100213](#) [T1142NL](#) [TG1G-S001NZLF](#) [T1124NL](#) [1879732-1](#) [2-1879391-5](#) [MABA-010321-CT1A42](#)
[TX1341NL](#) [H0013FNL](#) [H5020FNL](#) [H2009FNLT](#) [H5004NLT](#) [S553-5999-52-F](#) [SCMS7D43AY100PT1](#) [T5008NLT](#) [PE-68517T](#) [MGPWT-](#)
[00339-P](#) [H5014FNLT](#) [TX1473NLT](#) [PE-69011NLT](#) [CX2043LNLT](#) [H7137FNLT](#) [H1259NLT](#) [TX1344NLT](#) [LM-LP-1005L](#) [H0013NLT](#)
[S558-5500-JV](#) [TX1193NLT](#) [T7015NL](#) [T1124NLT](#)