

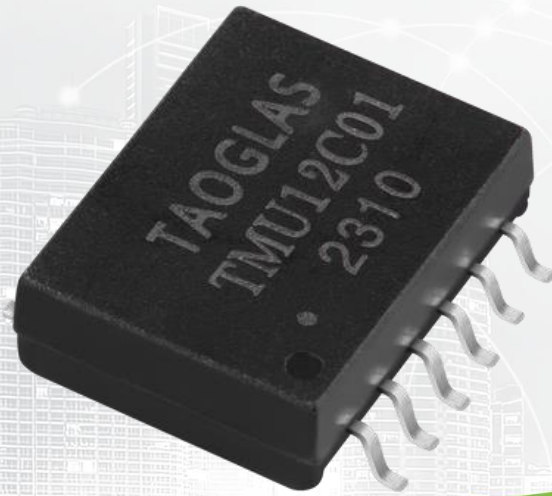

TAOGLAS®



Datasheet

BMS Transformer/CMC

Part No:
TMU12C01

Description:

Transformer with Common Mode Choke for Battery Management System
12 pin SMT

Features:

AEC-Q200
IATF 196949
Automotive grade
Dual channel

1. Introduction	3
2. Specifications	4
3. Mechanical	5
4. Electrical	6
5. Packaging	7
<hr/>	
Changelog	8

Taoglas makes no warranties based on the accuracy or completeness of the contents of this document and reserves the right to make changes to specifications and product descriptions at any time without notice. Taoglas reserves all rights to this document and the information contained herein. Reproduction, use or disclosure to third parties without express permission is strictly prohibited.



1. Introduction

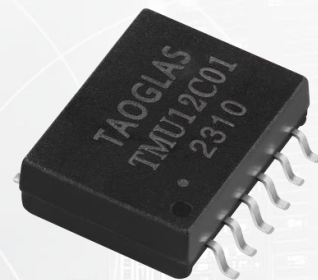

Featuring a compatible footprint with industry BMS transformers, and designed to work in demanding automotive environmental conditions, the Taoglas TMU12C01 is a BMS Transformer with Common Mode Choke of 12 pins and Dual channel for Operation voltage of 1000VDC.

The Taoglas Magnetics Product Team have over fifteen years of experience in magnetics design and high-quality manufacturing. With ever expanding portfolio, we provide trusted products and services to our customers within a wide range of applications such as:

- Electric Vehicle
- Energy Storage Systems
- Data Center UPS
- Solar energy storage
- Renewable Energy

Taoglas offers a full line of BMS transformers, and common mode chokes for energy storage systems that require serial port safety isolation and EMI noise suppression. These transformers are designed for battery systems with large voltage differences that demand component-to-component isolation.

The Taoglas BMS Transformers portfolio is intended to perform in highly energy-efficiency modern vehicles such as EVs, HEVs, and PHEVs.

All Taoglas parts meet AEC-Q200 requirements for automotive applications. For more information on the range of products or for assistance with integration, contact your regional Taoglas customer support team.

2. Specifications

Electrical Performance @25°C	
OCL	150μH ~ 450μH @100KHz/0.1V (-40°C to +125°C)
Leakage Inductance	0.5μH Max. @100KHz/0.1V
Turns Ratio (±2%)	1:1
D.C.R	0.80 ohm Max. @Transformer side
	0.10 ohm Max. @CM choke side
Insertion Loss	-0.25dB Max @4MHz
Return Loss	-22dB Min @4MHz (Z out= 100Ω)
CMRR	-35dB Min @1-100MHz
	-28dB Min @100-200MHz
Hi-Pot	4300VDC, 1mA ,60S
Design Construction	Functional insulation; Working voltage 1000VDC;

Environmental Specifications	
Operating Temperature	-40°C TO +125°C

Compliance	
UL recognized - FILE NO. E528697	
RoHS Compliant	
J-STD-020	

Storage requirements	
Humidity	MSL - 1
Storage Temperature	-50°C TO +125°C

3. Mechanical

3.1 Mechanical Drawings

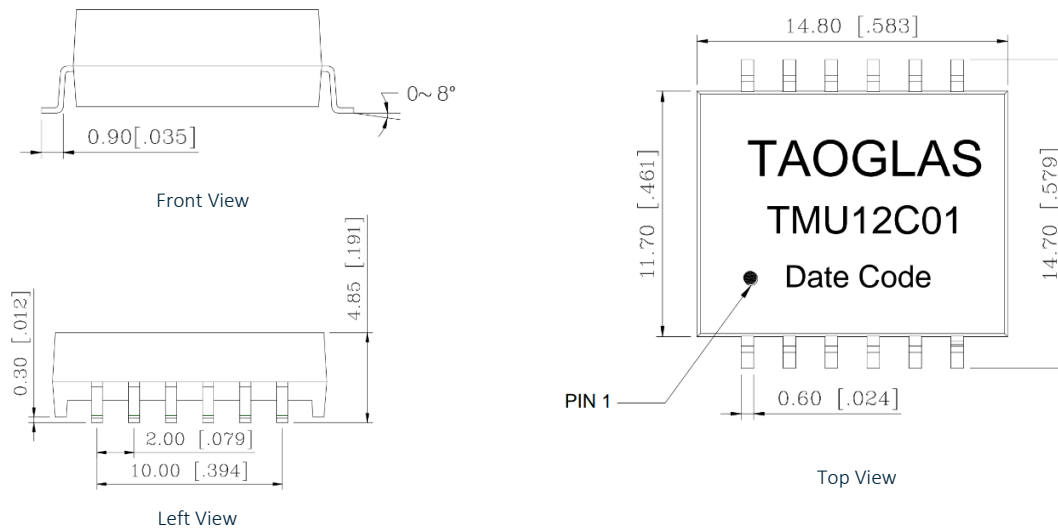

Mechanical Specifications	
Length	14.80 mm
Width	14.60 mm
Height	4.85 mm
Mounting Style	Surface Mount (SMT)

Dimensions are in millimeters with the following tolerances: X.XX = ± 0.25

3.2 Pad Layout

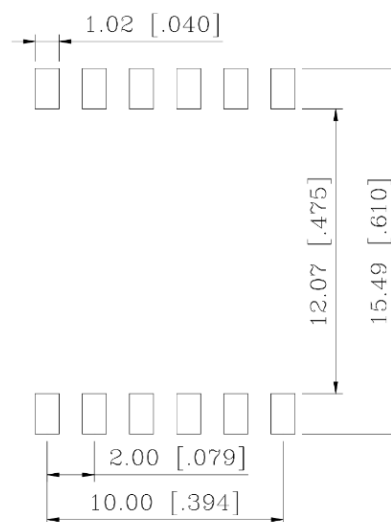

Suggested pad layout

Dimensions are in millimeters with the following tolerances: X.XX = ± 0.10

4. Electrical

4.1 Electrical Drawings

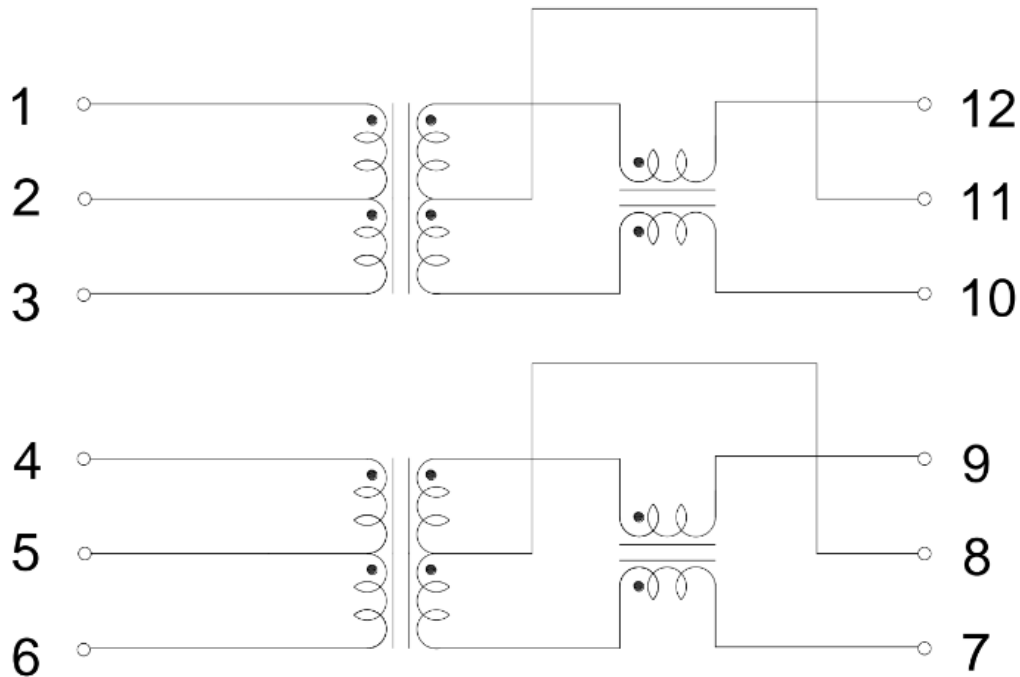

4.2 Profile of Reflow Solder

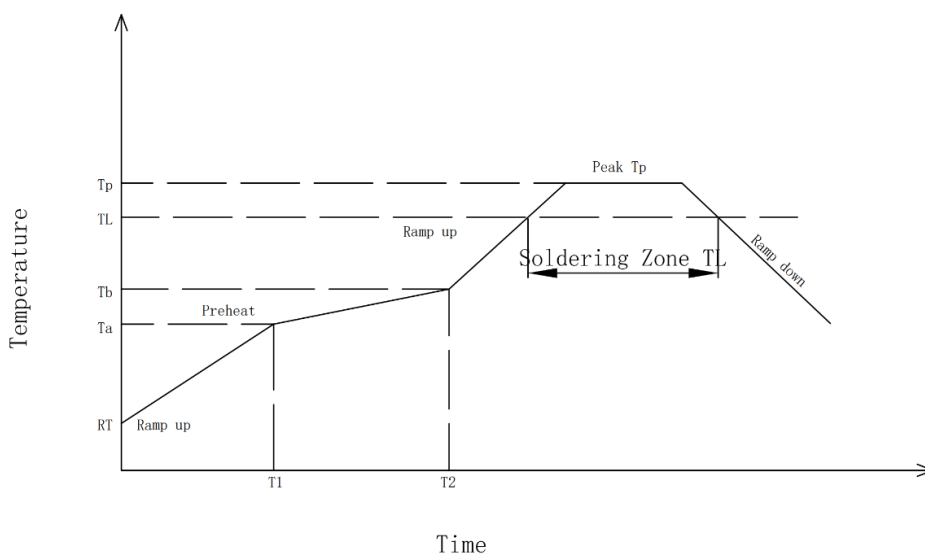

Preheat :
 Temperature (Ta-Tb):150-200°C
 Time(T1-T2):60-180s

Holding Temperature:217°C
 Time (TL):60-150s

Max Temperature (Tp):250(+0/-5°C)
 Max Time (Tp):30Sec±10Sec

The average speed:3°C/S Max
 The average cooling speed:6°C/S Max

From 25°C to Products out of the
 furnace:6 minutes Max

5. Packaging

5.1 SPQ

1 reel = 600 pcs
 Reel (mm): 24x11.5x15.5
 Weight (gr): 900

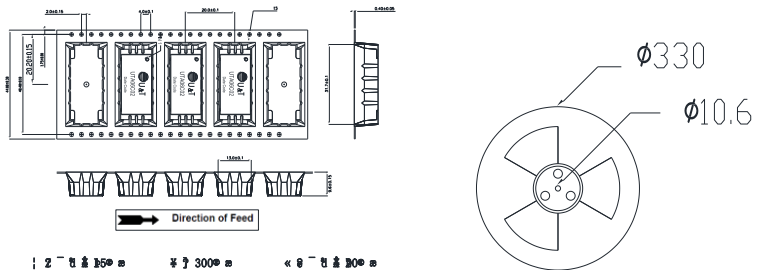

1 Carton = 9 reels = 5400 pcs
 Carton dimensions: 373*365*284 mm
 Carton Weight: 9.5 kg



5.2 Label

Taoglas Limited	
P/N NO: XXXXXXXX	
QYT: XXX PCS	DC: XXXX
DATE: XXXX-XX-XX	

SPQ Label (8x5cm)

Taoglas Limited	
P/N NO: XXXXXXXX	
PO: XXXXXXXX	B/N: XXXXXXXX
QYT: XXX PCS	DC: XXXX
DATE: XXXX-XX-XX	

Carton Label (8x5cm)

Changelog

Changelog for the datasheet

SPE-23-8-063 – TMU12C01

Revision: B

Date:	2024-07-22
Notes:	Spec update
Author:	Javier Vasena

Previous Revisions

Revision: A (Original First Release)

Date:	2023-03-30
Notes:	
Author:	Javier Vasena



www.taoglas.com



X-ON Electronics

Largest Supplier of Electrical and Electronic Components

Click to view similar products for [Power Transformers](#) category:

Click to view products by [Taoglas](#) manufacturer:

Other Similar products are found below :

[F-181U](#) [F-204U](#) [F-206U](#) [F-227X](#) [F-23U](#) [F-264U](#) [F-267U](#) [F-35U](#) [F-412X](#) [F-55X-1](#) [F-68U](#) [F-71U](#) [F-72Z](#) [F-74U](#) [F-83A](#) [F-84AC](#) [F-85U](#) [F-86U](#) [F-9U](#) [PCT-02](#) [PCT-03](#) [PCT6630](#) [PF2.5-20](#) [PPC-14](#) [PPC-46](#) [PPC-58](#) [PSD4-36](#) [GSD-150](#) [11E009H](#) [11E012H](#) [DSW-2120](#) [DSW-224](#) [DSW-228](#) [DSW-310](#) [DSW-3120](#) [DSW-356](#) [DSW-412](#) [DSW-4120](#) [DSW-424](#) [DSW-448](#) [DSW-456](#) [DSW-556](#) [DSW-610](#) [DSW-6120](#) [DSW-624](#) [DSWC-712](#) [EN216B](#) [N-39X](#) [N-49X](#) [N-4MG-1](#)