



TAOGLAS®



Datasheet

Stingray

Part No:

WA.500w.301151

Description:

Stingray Dual-band Wi-Fi Adhesive Mount Antenna with 3m RG-174 cable and RP-SMA(M)ST Connector

Features:

Dual-Band Wi-Fi: 2.4GHz/5.8GHz

Covers Frequencies required for Bluetooth, Wi-Fi and ZigBee applications

IP65 Waterproof Rated

Cable: 3m RG-174

Connector: Reverse Polarity SMA Male Straight

Cable and connector customizable

RoHS & Reach Compliant

1. Introduction	3
2. Specifications	4
3. Test Setup	6
4. Antenna Characteristics	8
5. Radiation Patterns	10
6. Mechanical Drawing	16
7. Packaging	17
8. Application Note	18
<hr/>	
Changelog	24

Taoglas makes no warranties based on the accuracy or completeness of the contents of this document and reserves the right to make changes to specifications and product descriptions at any time without notice. Taoglas reserves all rights to this document and the information contained herein. Reproduction, use or disclosure to third parties without express permission is strictly prohibited.



1. Introduction



The WA.500w Stingray is a high efficiency, high gain adhesive mount dual band wireless antenna. Its high quality low profile covert housing can be attached onto the glass or plastic. The WA.500w is designed for applications that require omni-directional gain across both bands to ensure wide coverage area and constant reception and transmission for Wi-Fi and ZigBee applications.

Many module manufacturers specify peak gain limits for any antennas that are to be connected to that module. Those peak gain limits are based on free-space conditions. In practice, the peak gain of an antenna tested in free-space can degrade by at least 1 or 2dBi when put inside a device. So ideally you should go for a slightly higher peak gain antenna than mentioned on the module specification to compensate for this effect, giving you better performance.

Upon testing of any of our antennas with your device and a selection of appropriate layout, integration technique, or cable, Taoglas can make sure any of our antennas' peak gain will be below the peak gain limits. Taoglas can then issue a specification and/or report for the selected antenna in your device that will clearly show it complying with the peak gain limits, so you can be assured you are meeting regulatory requirements for that module.

For example, a module manufacturer may state that the antenna must have less than 2dBi peak gain, but you don't need to select an embedded antenna that has a peak gain of less than 2dBi in free-space. This will give you a less optimized solution. It is better to go for a slightly higher free-space peak gain of 3dBi or more if available. Once that antenna gets integrated into your device, performance will degrade below this 2dBi peak gain due to the effects of GND plane, surrounding components, and device housing. If you want to be absolutely sure, contact Taoglas and we will test. Choosing a Taoglas antenna with a higher peak gain than what is specified by the module manufacturer and enlisting our help will ensure you are getting the best performance possible without exceeding the peak gain limits.

Cables and Connectors are fully customizable, for further information please contact your regional Taoglas customer support team.

2. Specifications

Wi-Fi MIMO			
Frequency (MHz)		2400~2500	5150~5850
Efficiency (%)			
Free space	0.5m	46.1	61.4
	1.0m	36.8	43.3
	2.0m	26.6	26.2
	3.0m	19.3	15.9
	5.0m	10.1	5.8
On 6mm Glass	0.5m	24.5	49.8
	1.0m	19.5	35.0
	2.0m	14.2	21.2
	3.0m	10.3	12.8
	5.0m	5.4	4.7
on 2mm ABS Plastic	0.5m	36.9	63.7
	1.0m	29.4	44.8
	2.0m	21.3	27.2
	3.0m	15.4	16.5
	5.0m	8.1	6.0
Average Gain (dB)			
Free space	0.5m	-3.37	-2.12
	1.0m	-4.35	-3.64
	2.0m	-5.75	-5.82
	3.0m	-7.15	-7.99
	5.0m	-9.95	-12.34
On 6mm Glass	0.5m	-6.11	-3.03
	1.0m	-7.09	-4.55
	2.0m	-8.49	-6.73
	3.0m	-9.89	-8.91
	5.0m	-12.69	-13.27
on 2mm ABS Plastic	0.5m	-4.33	-1.96
	1.0m	-5.31	-3.48
	2.0m	-6.71	-5.66
	3.0m	-8.11	-7.84
	5.0m	-10.91	-12.19

Peak Gain (dBi)			
Free space	0.5m	3.7	3.65
	1.0m	2.74	2.06
	2.0m	1.06	-0.36
	3.0m	-0.21	-2.33
	5.0m	-3.01	-6.29
On 6mm Glass	0.5m	0.45	4.12
	1.0m	-0.13	3.01
	2.0m	-1.93	1.17
	3.0m	-3.33	-1.34
	5.0m	-6.13	-5.70
on 2mm ABS Plastic	0.5m	3.67	4.78
	1.0m	2.39	3.86
	2.0m	1.01	1.88
	3.0m	-0.11	-0.7
	5.0m	-2.81	-5.16
Impedance	50 Ω		
Polarization	Linear		
Return Loss	<-10dB		

Mechanical	
Housing Material	PC
Dimensions	Diameter 51.4mm*Height 11.87mm
Color	Black
Connector	RP-SMA(M), Fully Customizable
Cable	3000mm RG174 Length Fully Customizable
Weight	62g
Environmental	
Protection	IP65
Temperature Range	-40°C to 85°C
Humidity	Non-condensing 65°C 95% RH

3. Test Setup

3.1 S11/VSWR/Return Loss

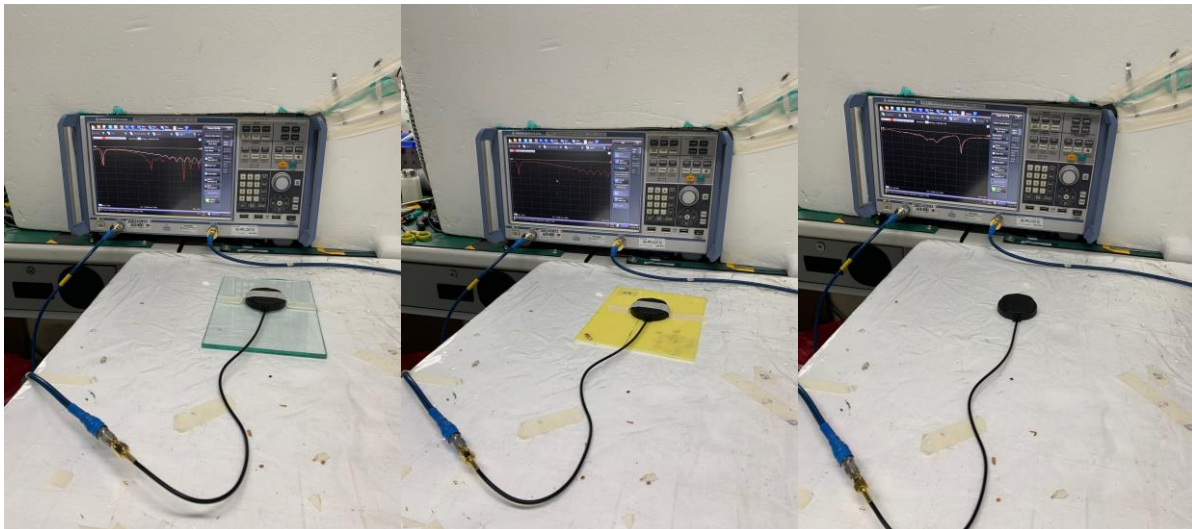
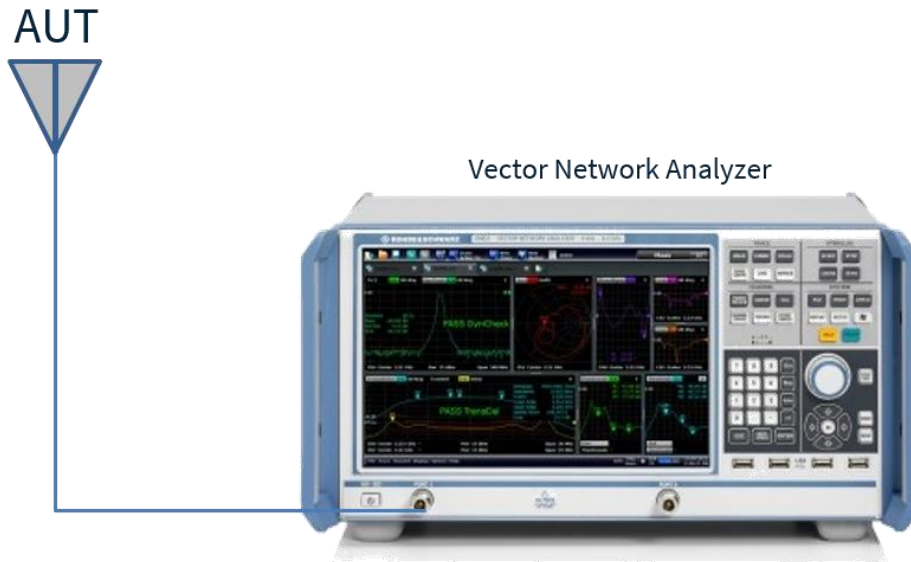

On 6mm GLASS

On 2mm ABS Plastic

Free Space

3.2 Radiation Performance

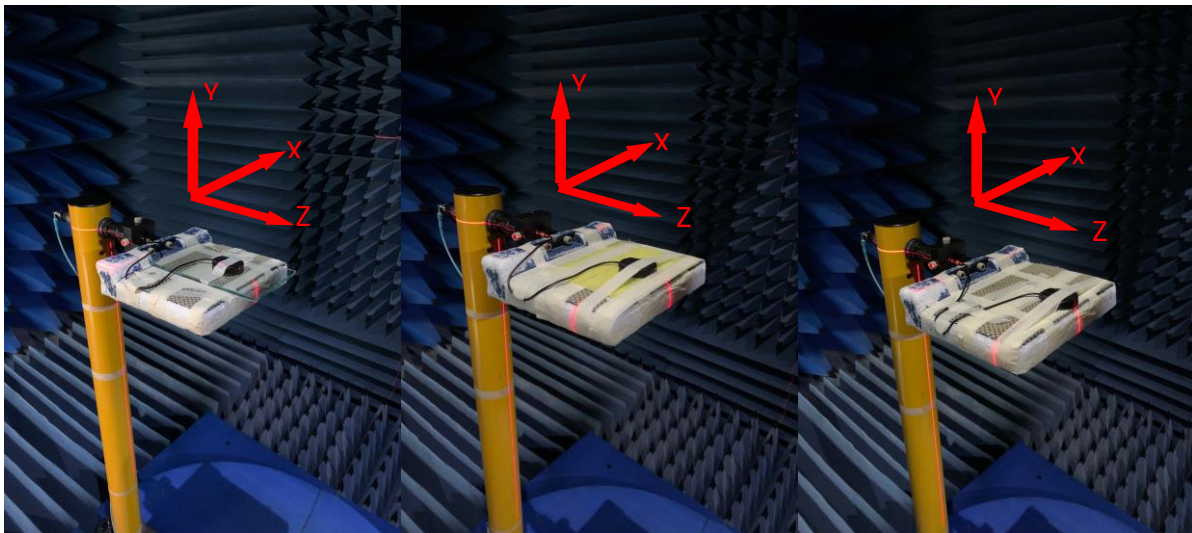
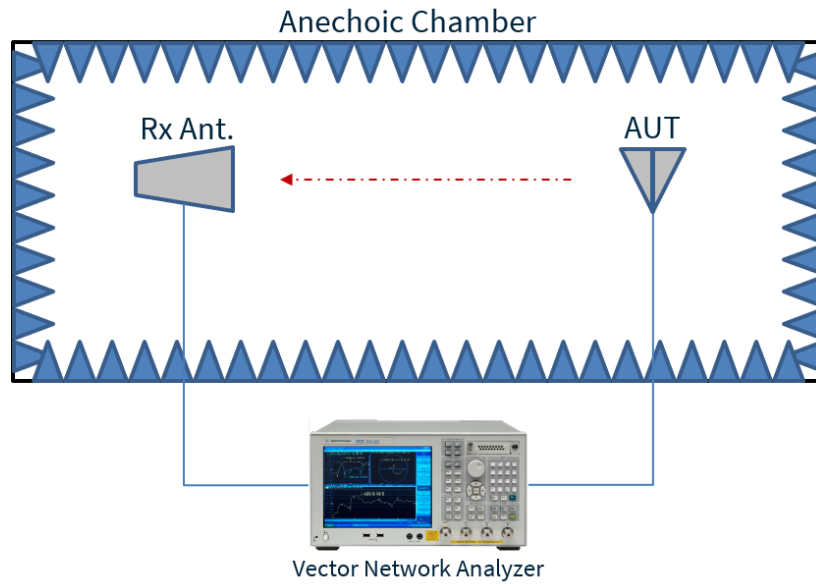

On 6mm GLASS

On 2mm ABS Plastic

Free Space

4. Antenna Characteristics

4.1 Return Loss

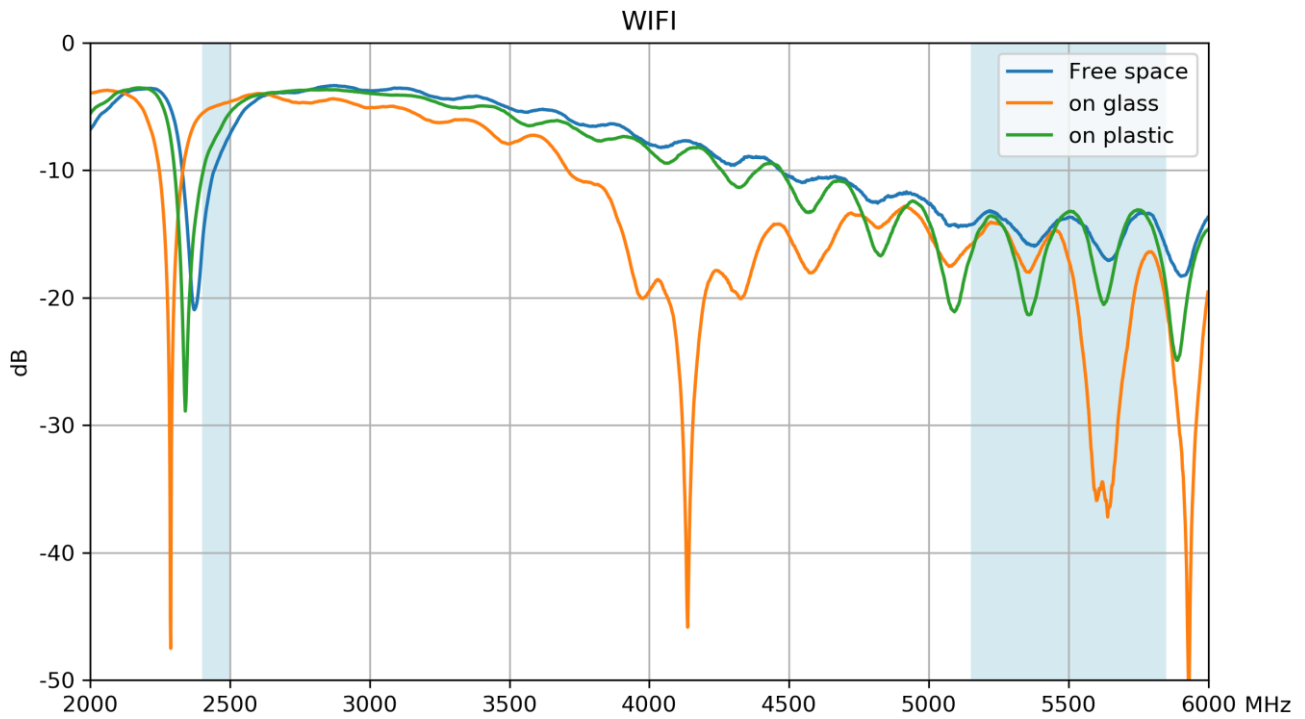

4.2 Efficiency

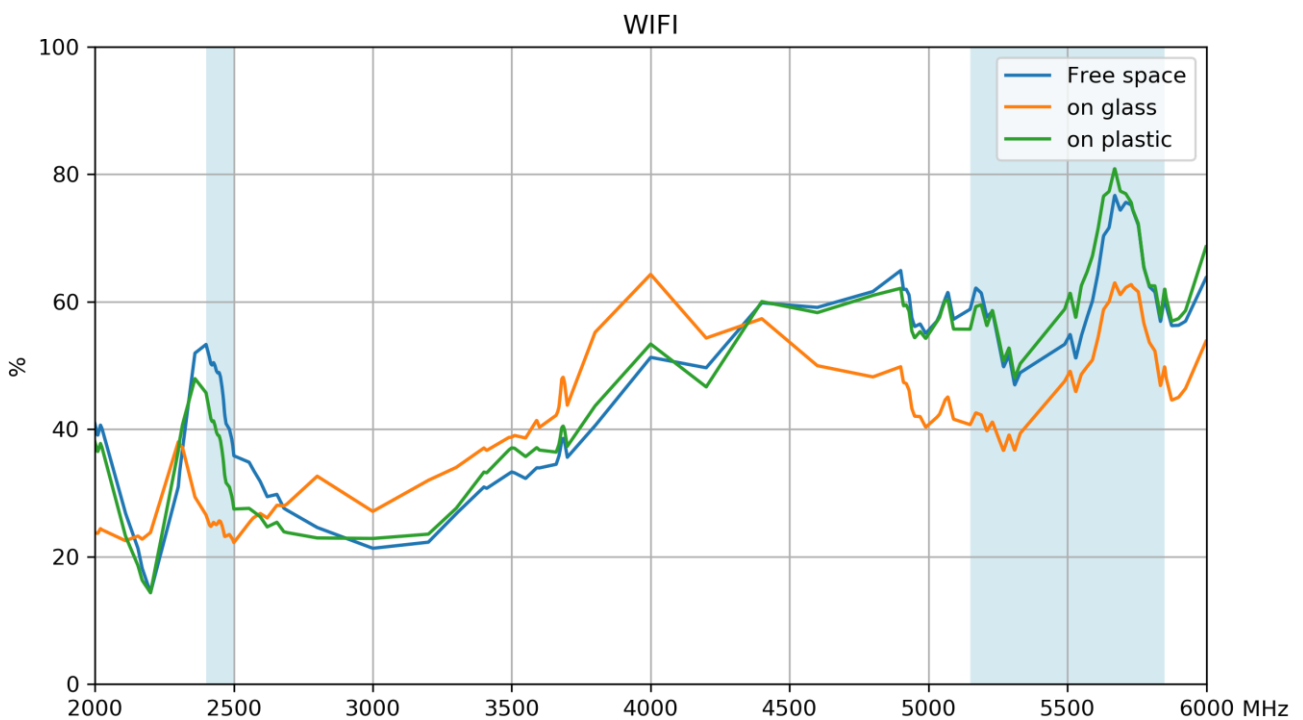

4.3 Average Gain

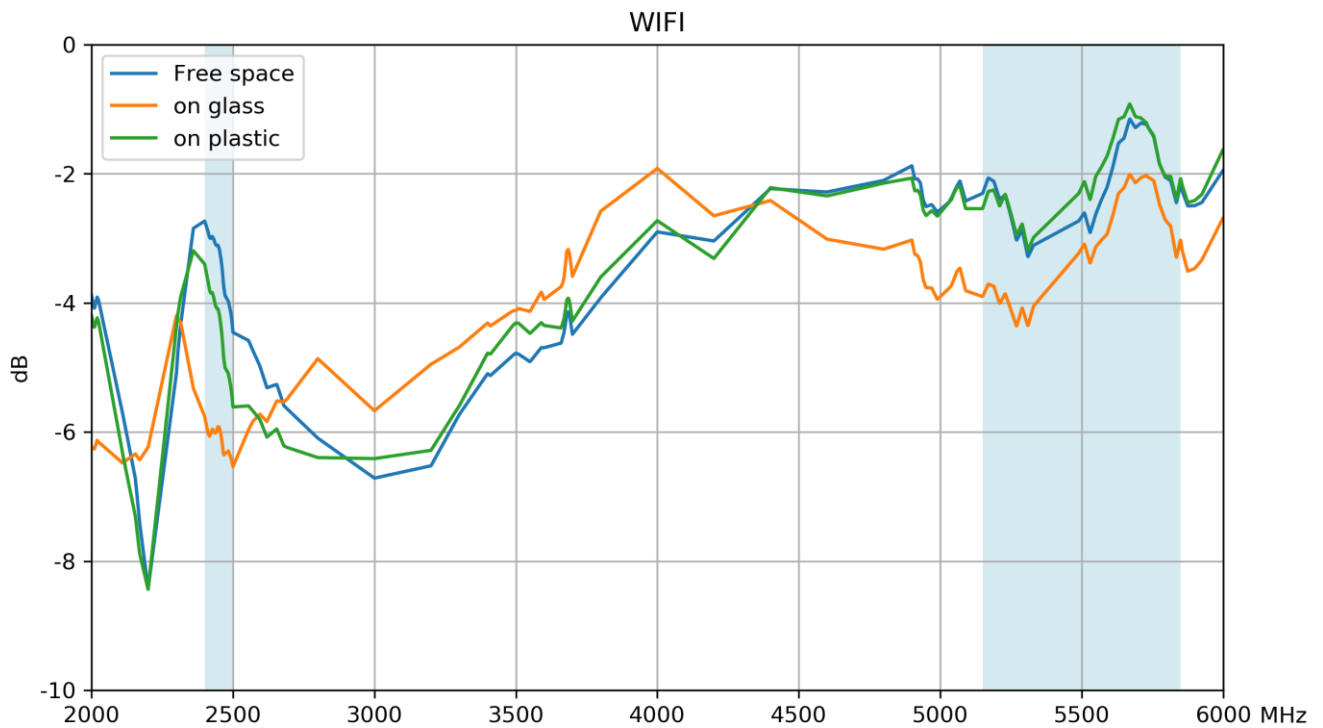

4.4 Peak Gain

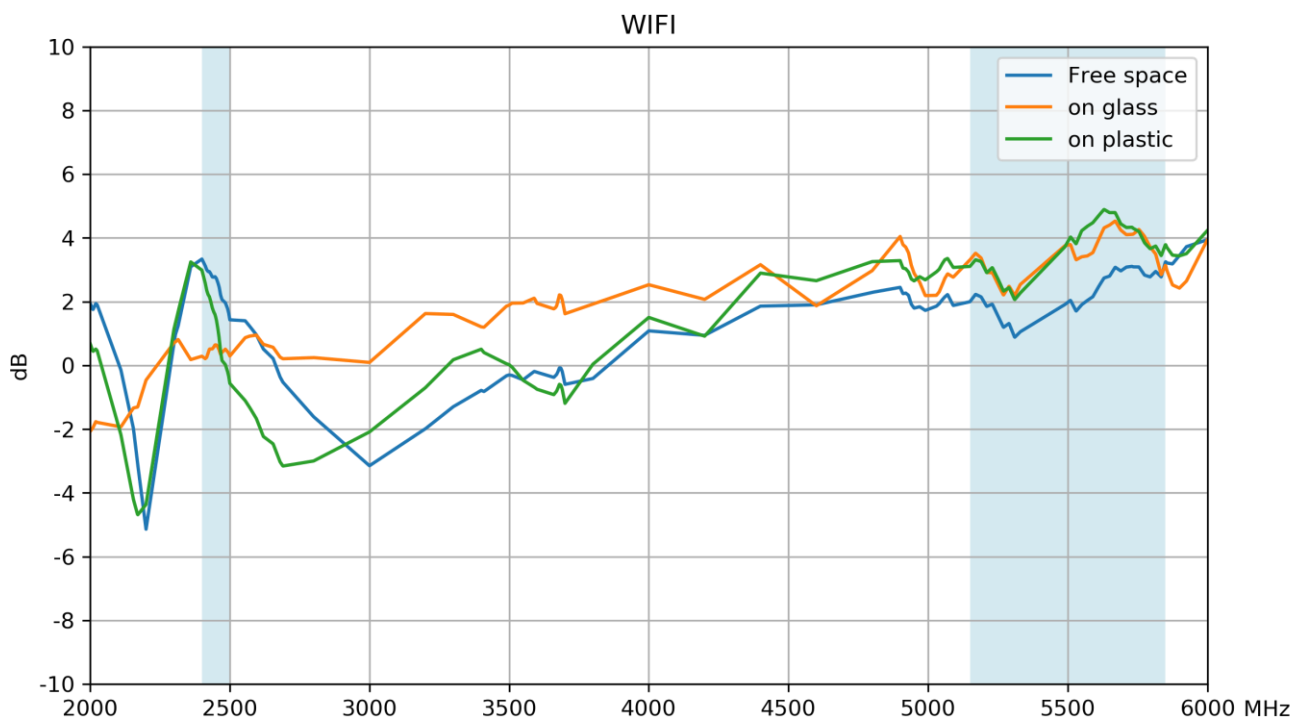

5. Radiation Patterns

5.1 3D and 2D Radiation Patterns – Free Space

2450MHz

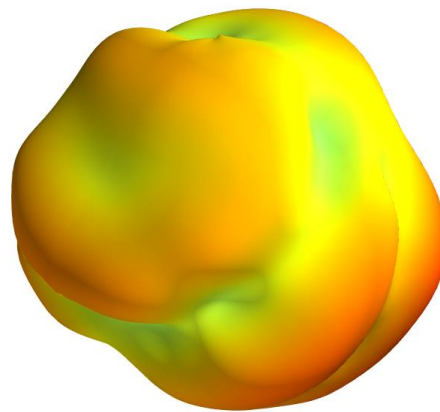

XY Plane

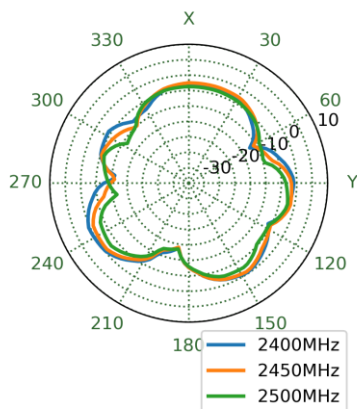

XZ Plane

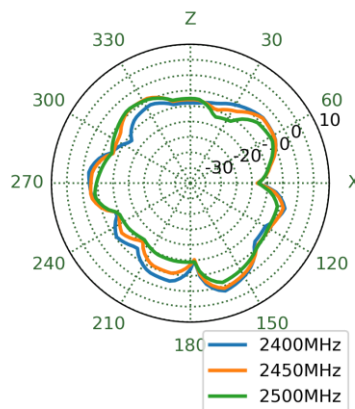

YZ Plane

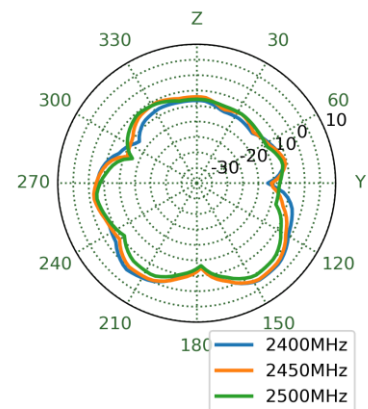

5550MHz

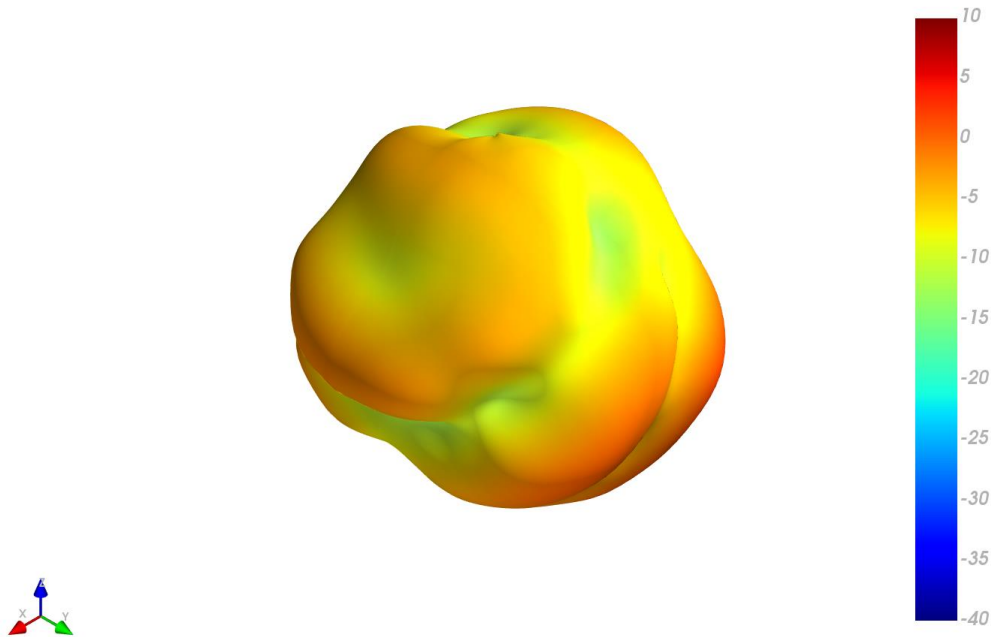

XY Plane

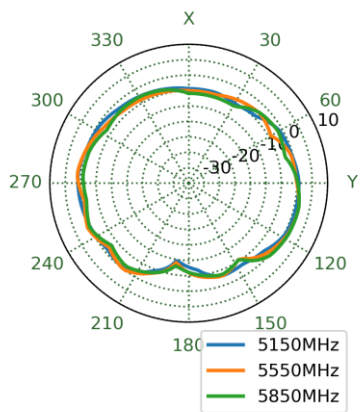

XZ Plane

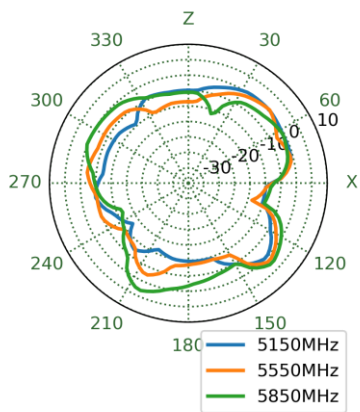

YZ Plane

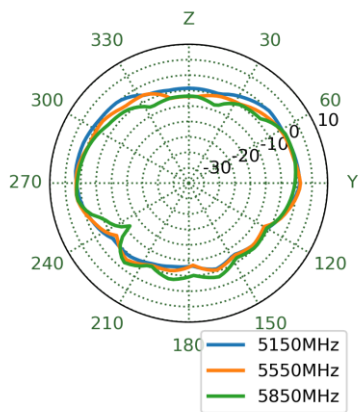

5.2 3D and 2D Radiation Patterns – On 2mm ABS Plastic

2450MHz

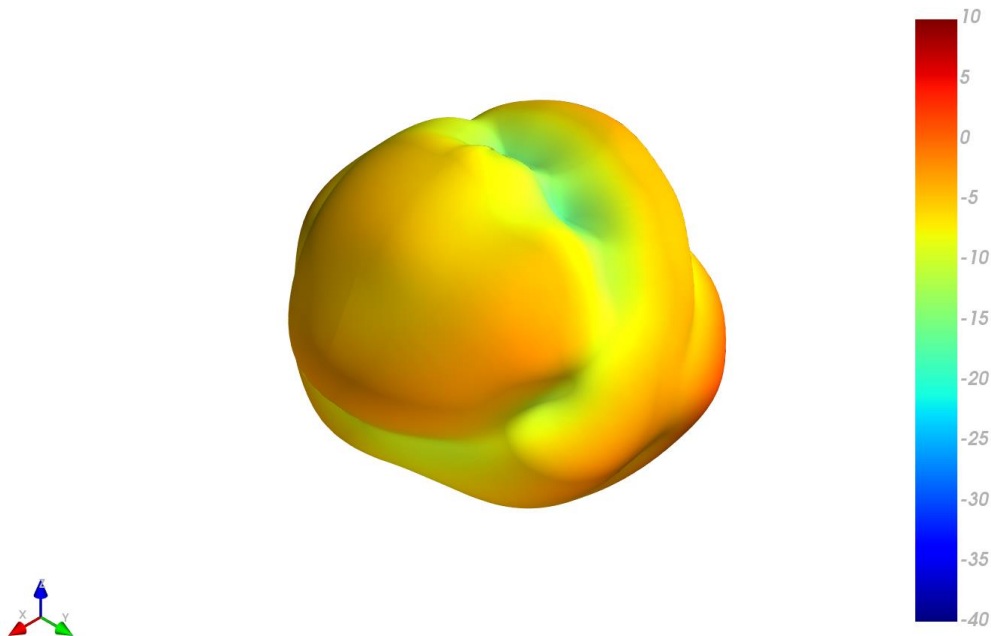

XY Plane

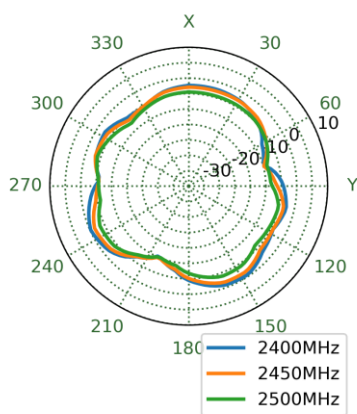

XZ Plane

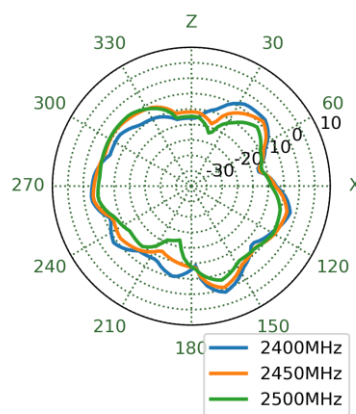

YZ Plane

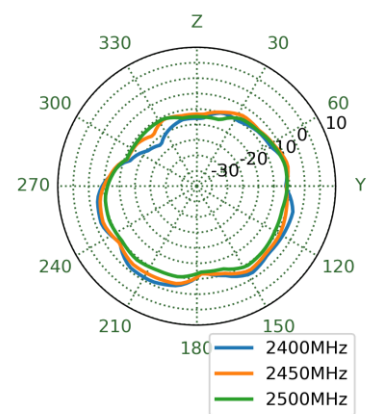

5550MHz

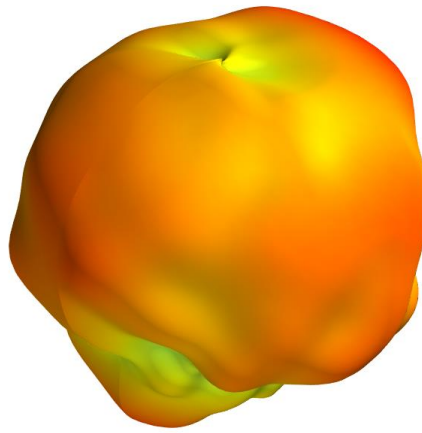

XY Plane

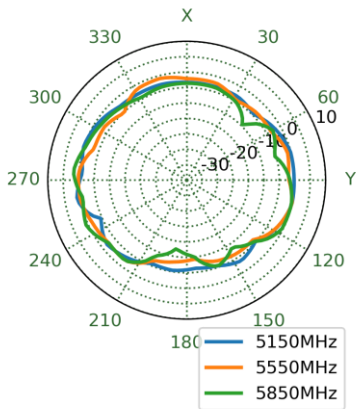

XZ Plane

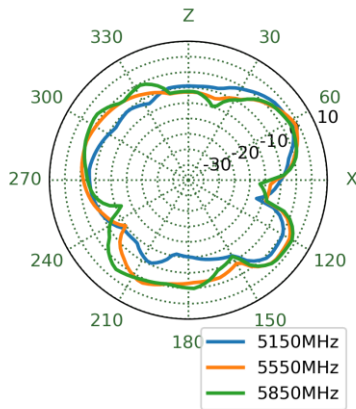

YZ Plane

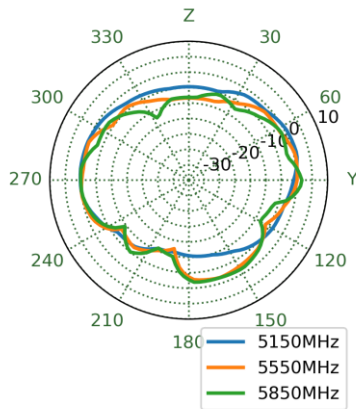

5.3 3D and 2D Radiation Patterns – On 6mm Glass

2450MHz

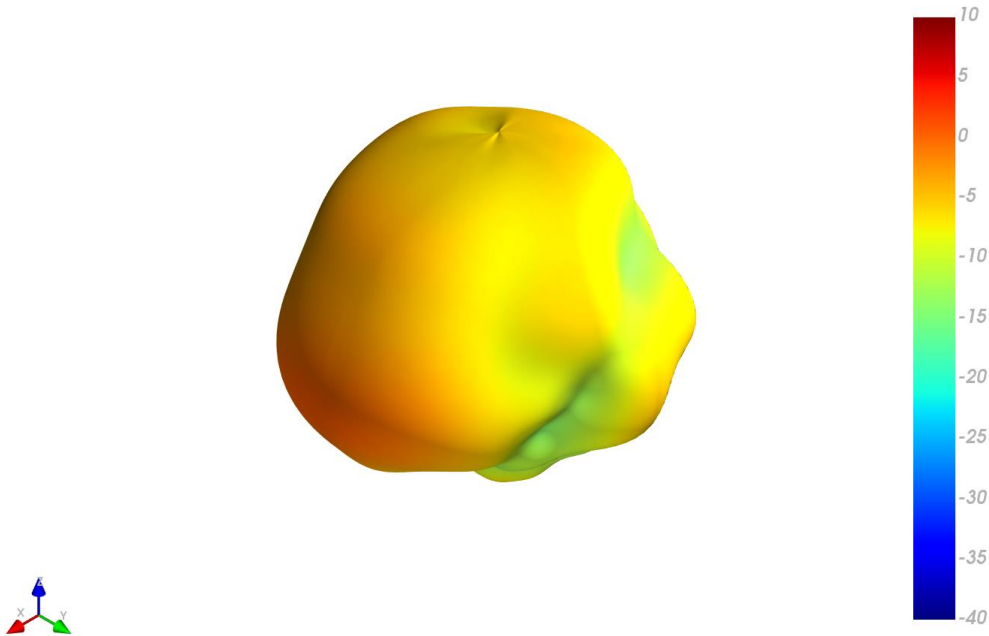

XY Plane

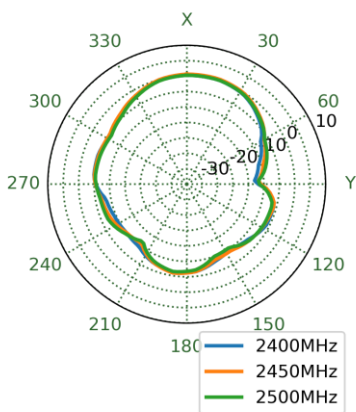

XZ Plane

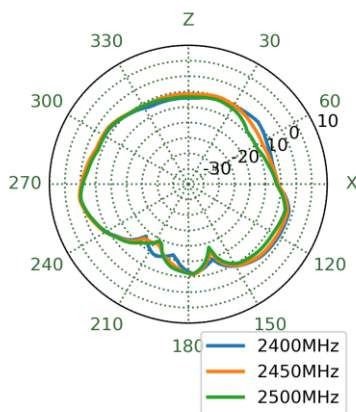

YZ Plane

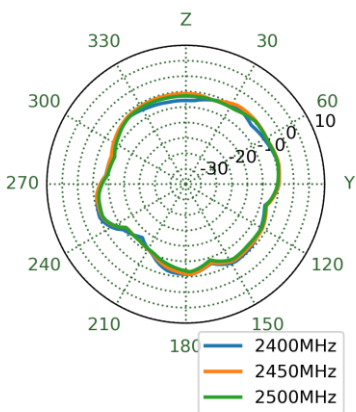

5550MHz

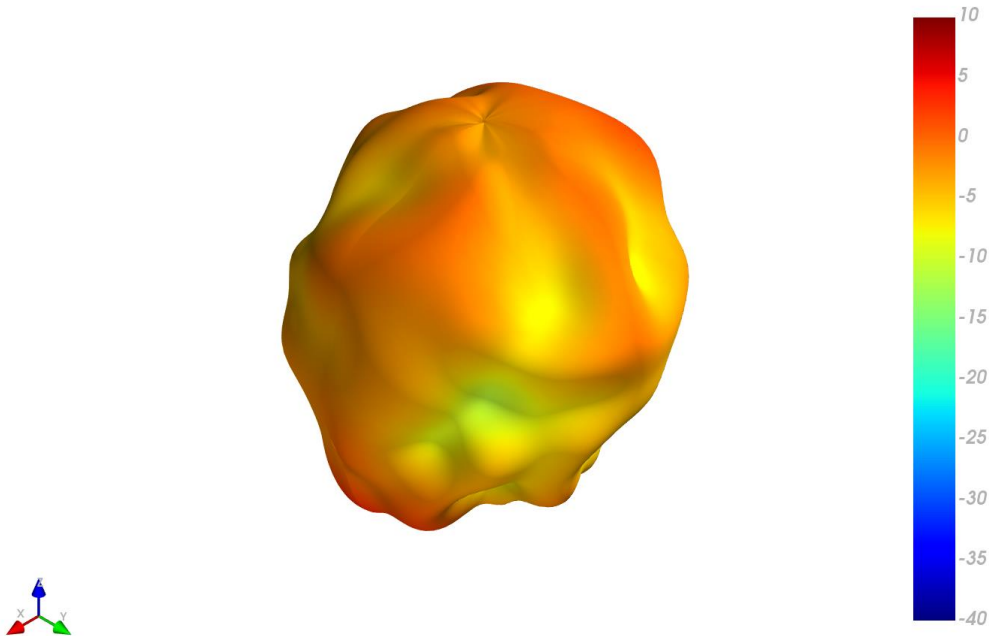

XY Plane

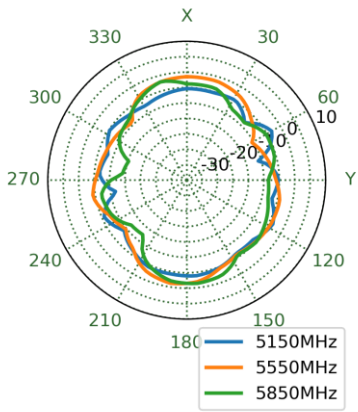

XZ Plane

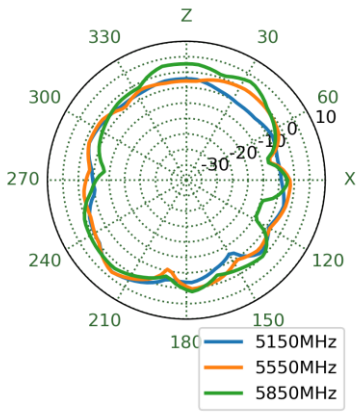

YZ Plane

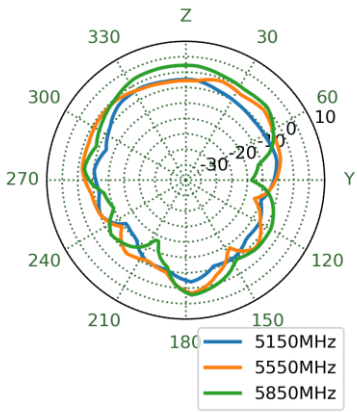

6. Mechanical Drawing (Units: mm)

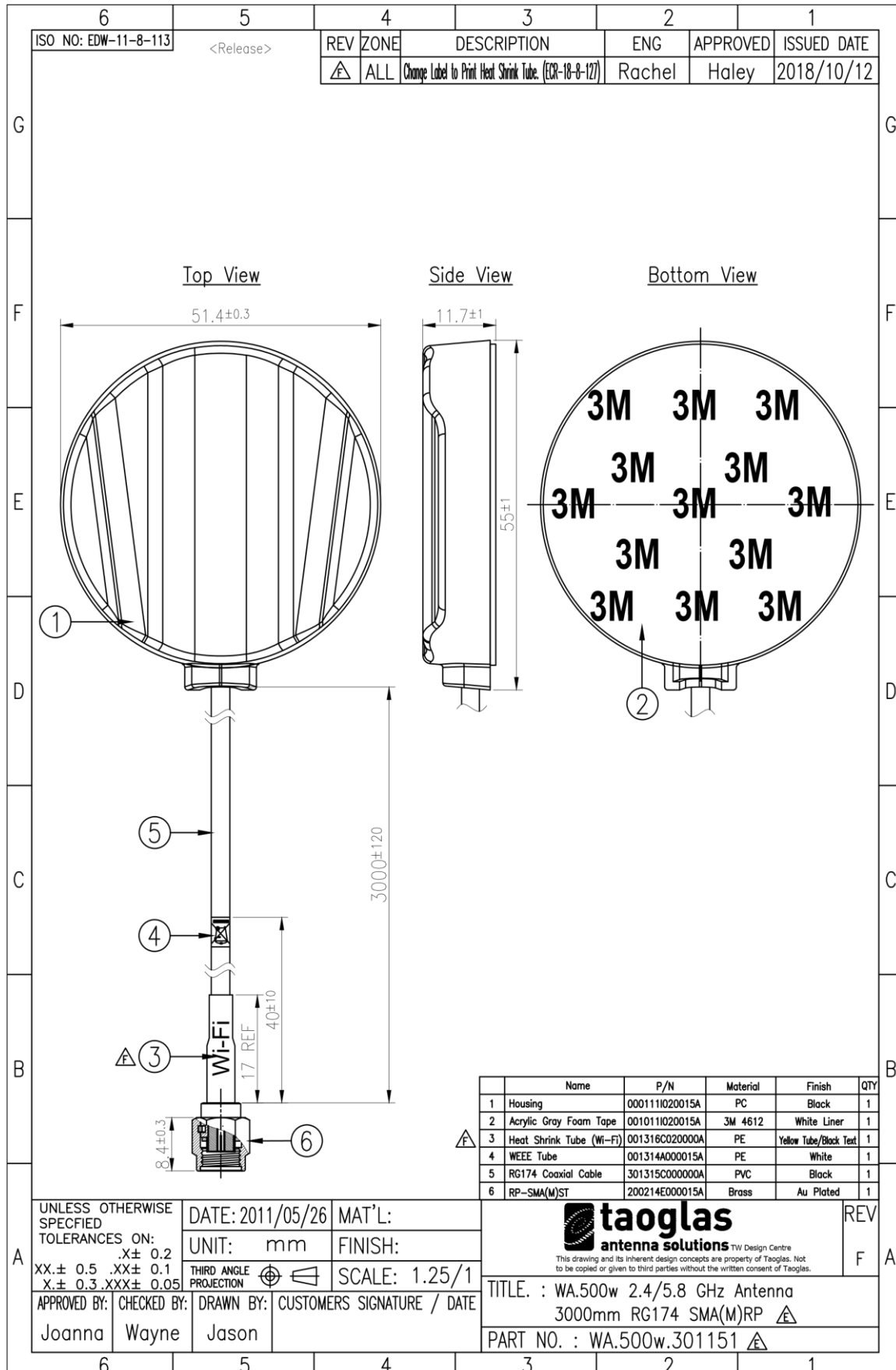

7. Packaging

WA.500w.301151

Packaging Specifications

1pc WA.500w.301151 per PE bag
 Bag Dimensions - 100*220mm
 Weight - 64.1g

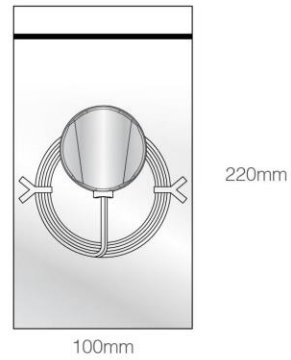

100 PE bags in one carton
 Carton Dimensions - 400*340*220mm
 Weight - 7.4Kg

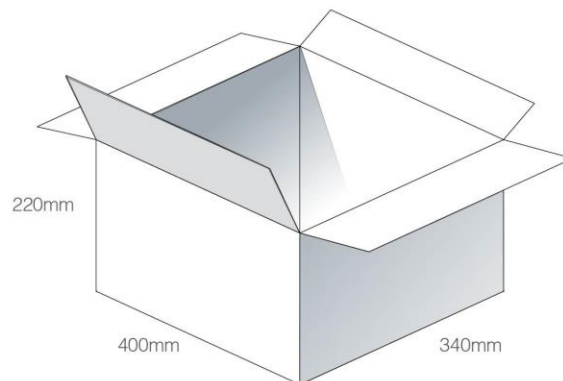

Pallet Dimensions 1100*1100*1450mm
 48 Cartons per Pallet
 8 Cartons per layer
 6 Layers

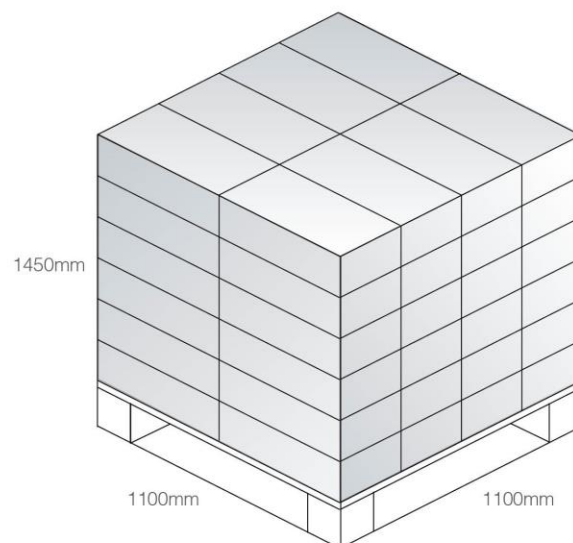

8. Application Note

8.1 Return Loss

Free Space

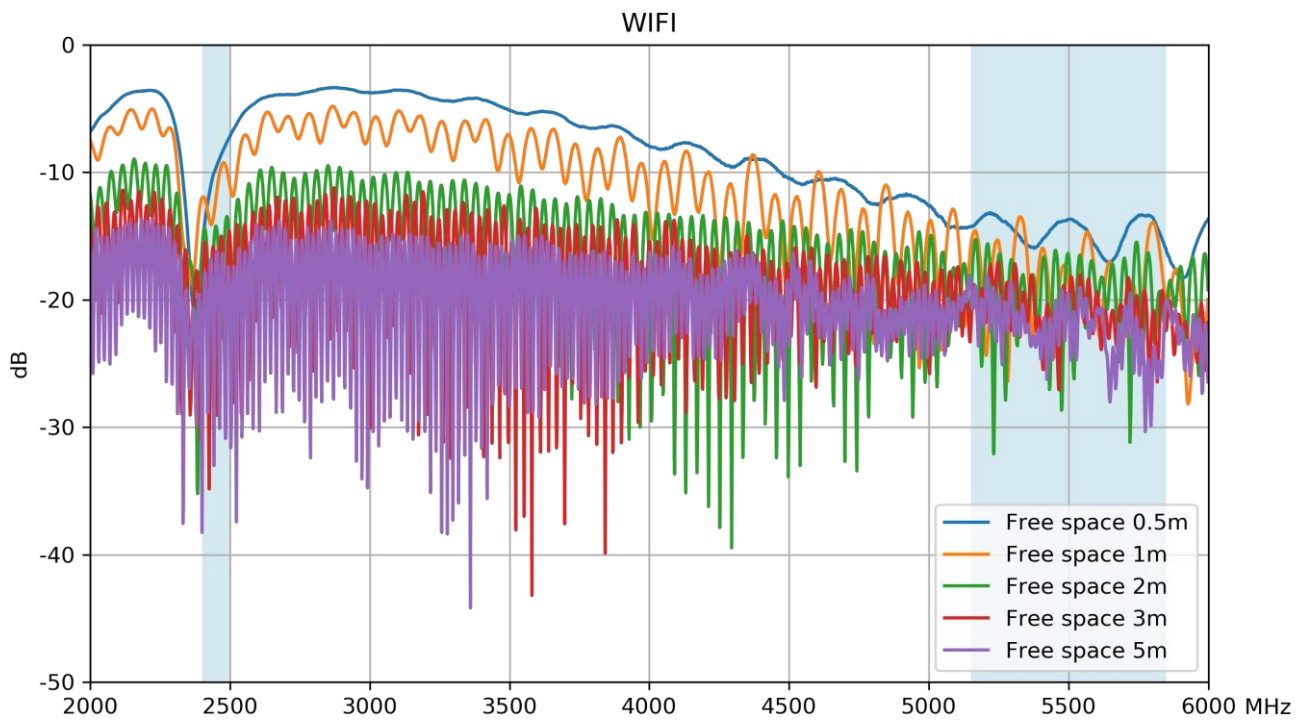

On 6mm Glass

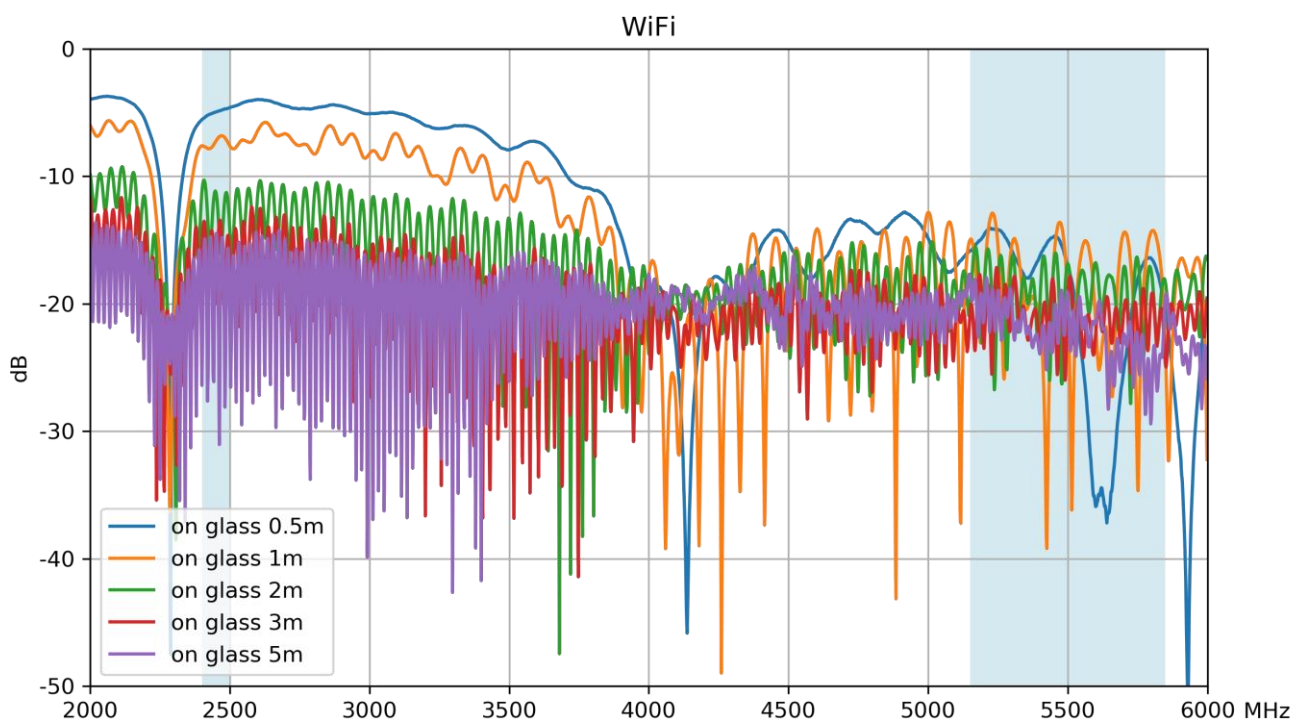

On 2mm ABS Plastic

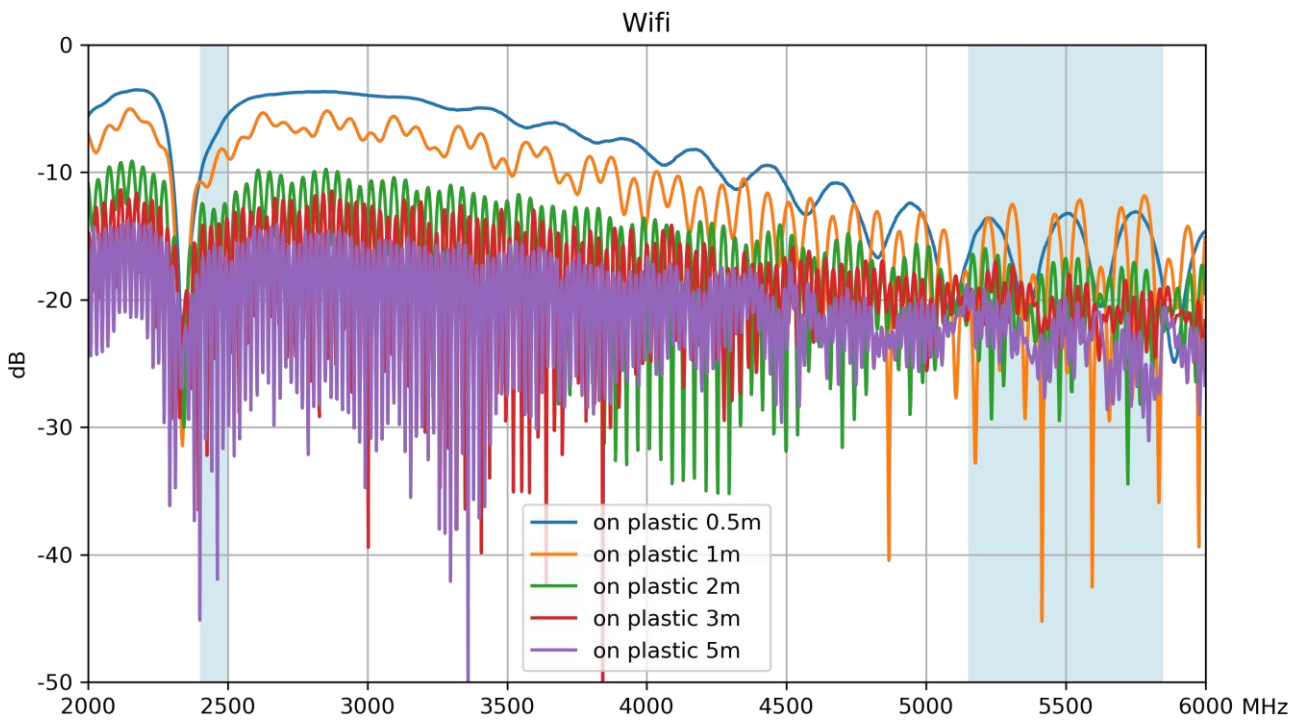

8.2 Efficiency

Free Space

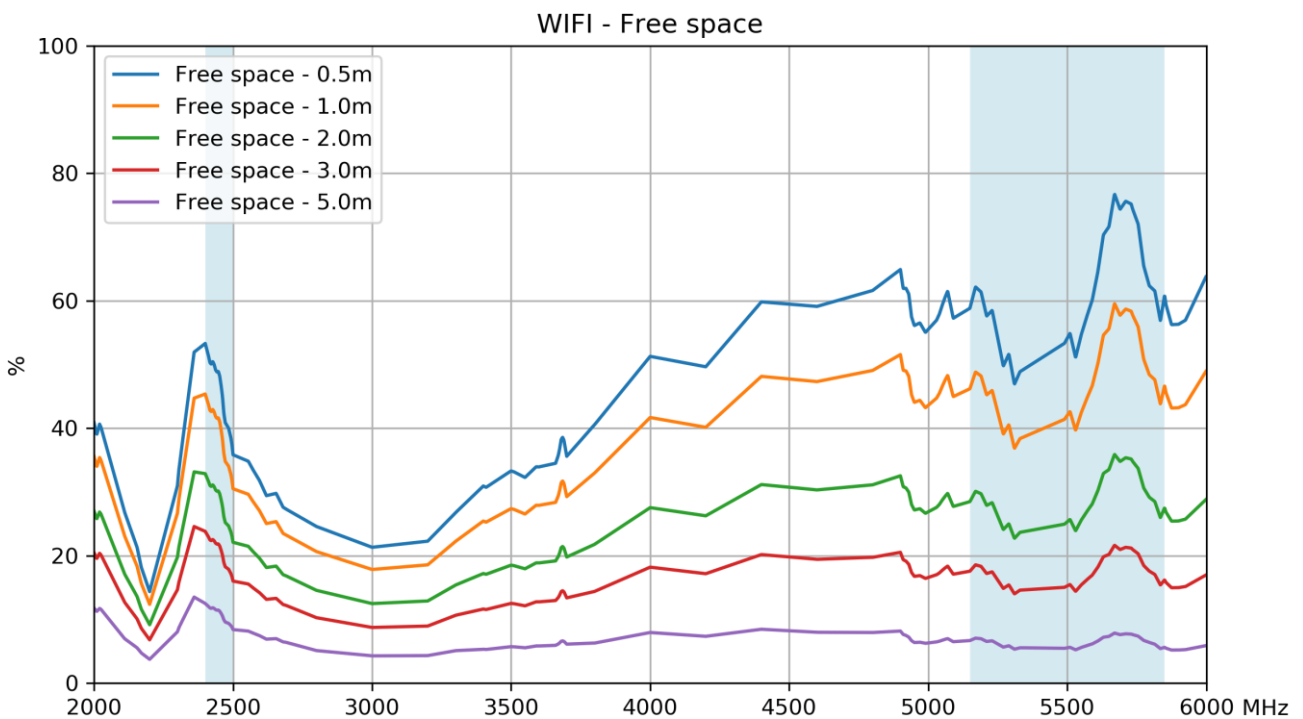

On 6mm Glass

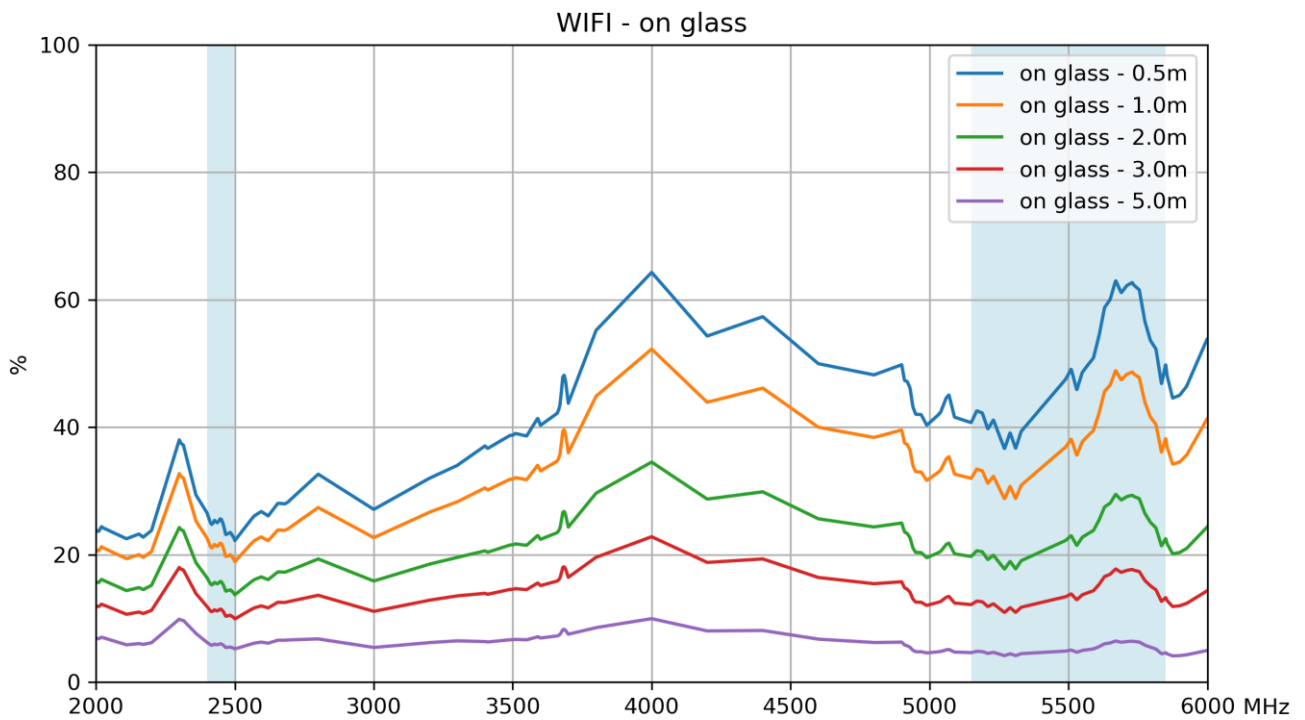

On 2mm ABS Plastic

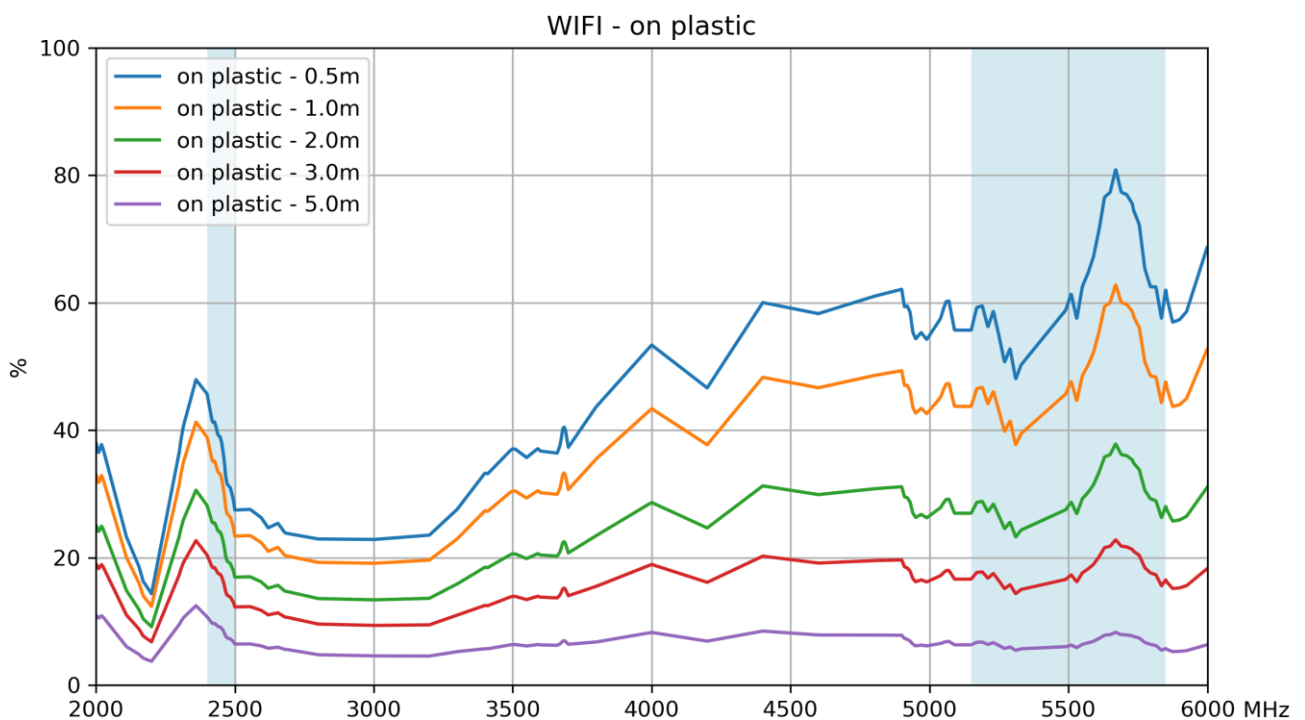

8.3 Average Gain

Free Space

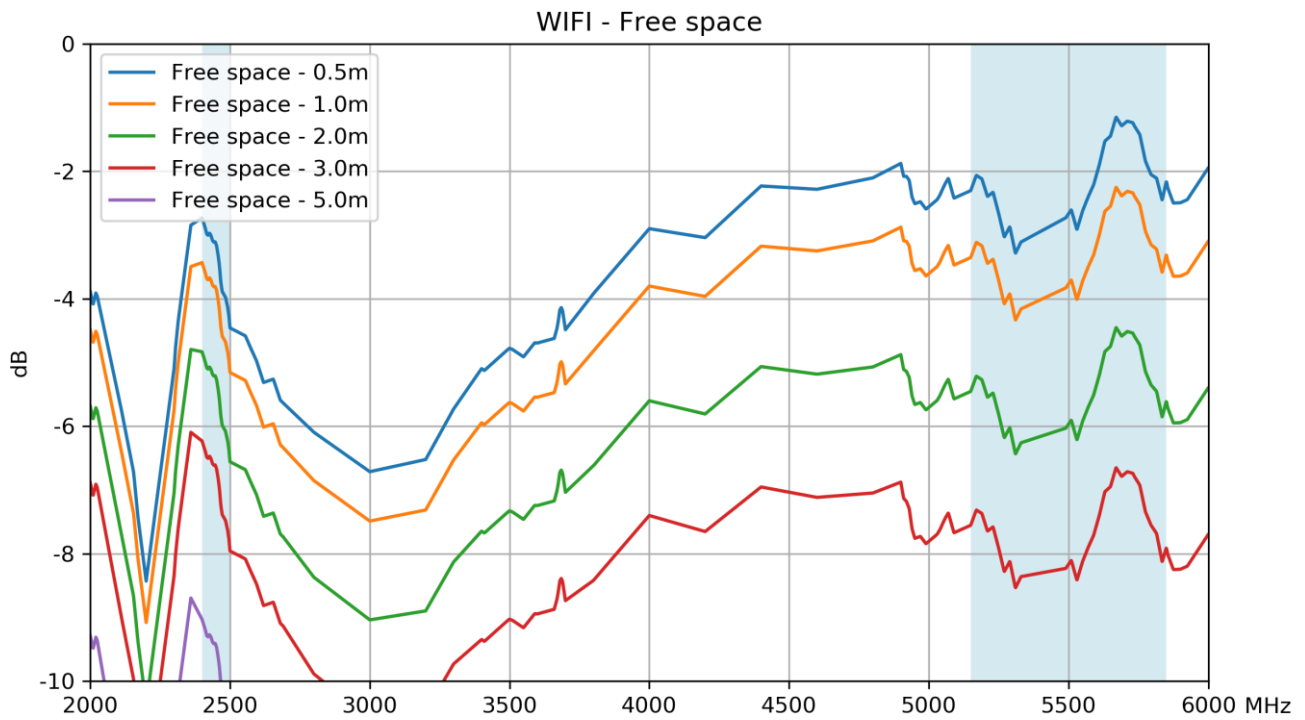

On 6mm Glass



On 2mm ABS Plastic

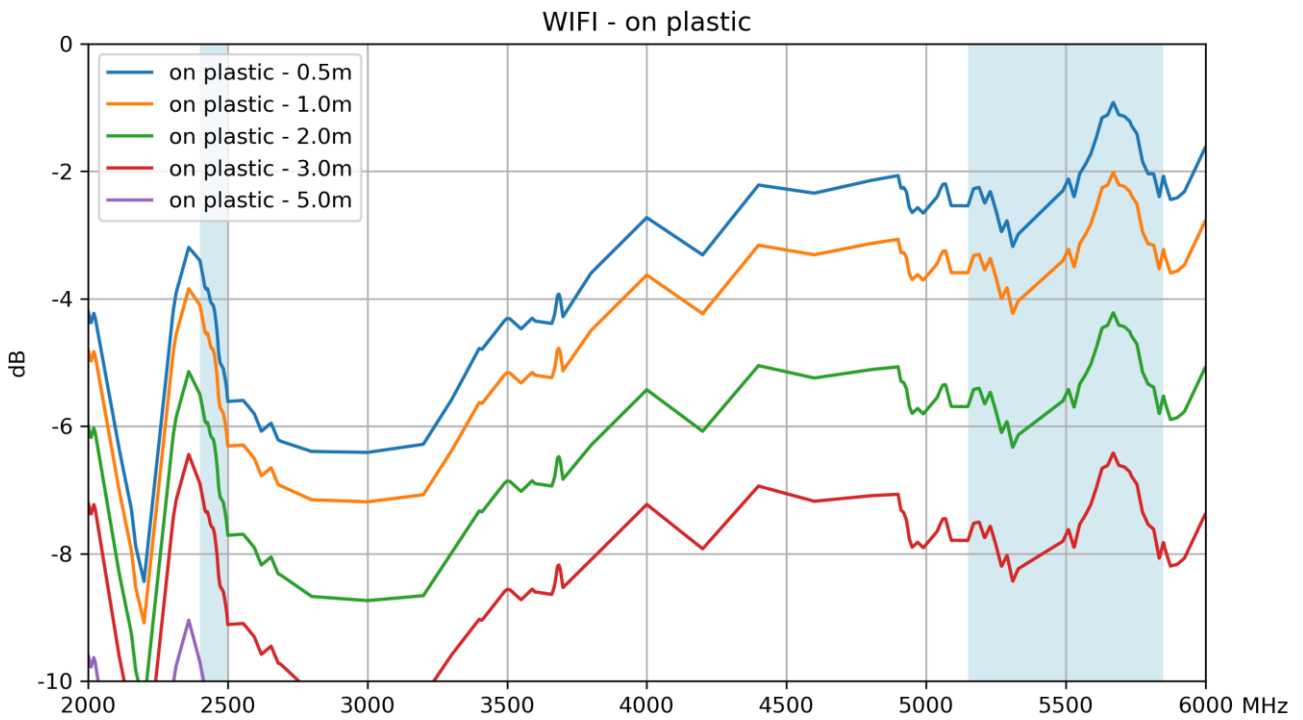

8.4 Peak Gain Free Space

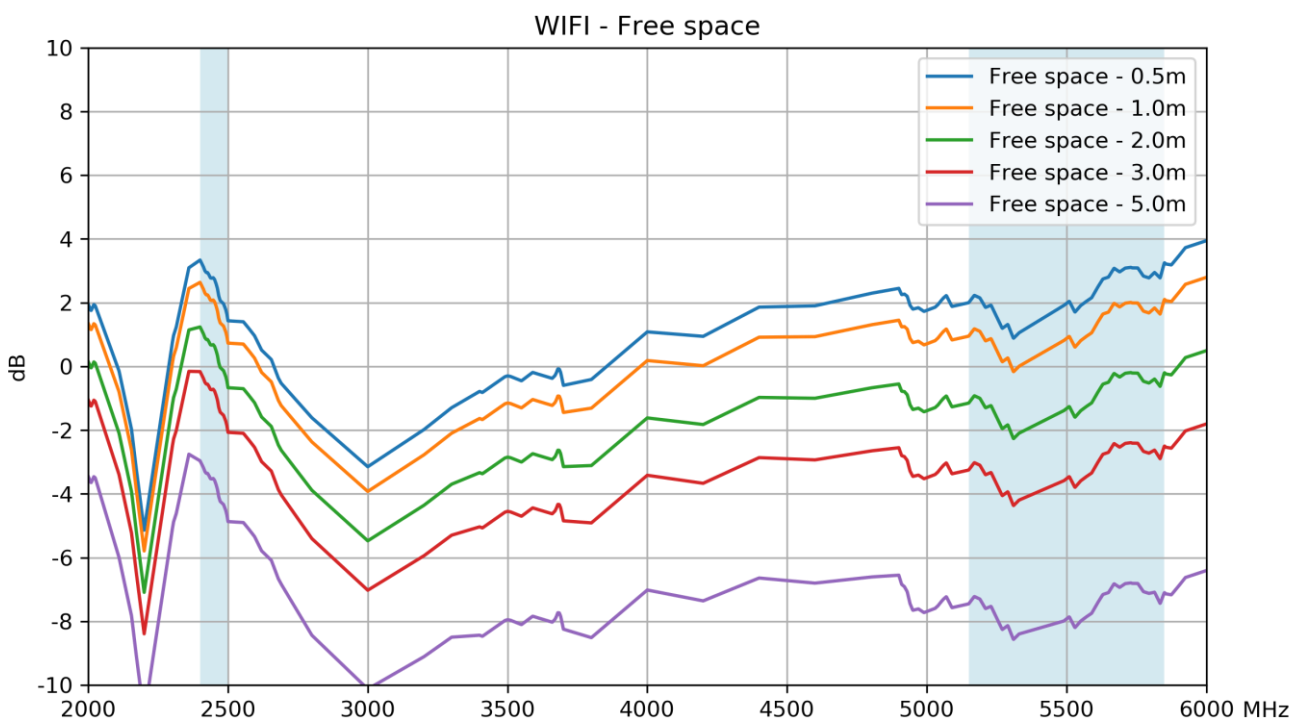

On 6mm Glass

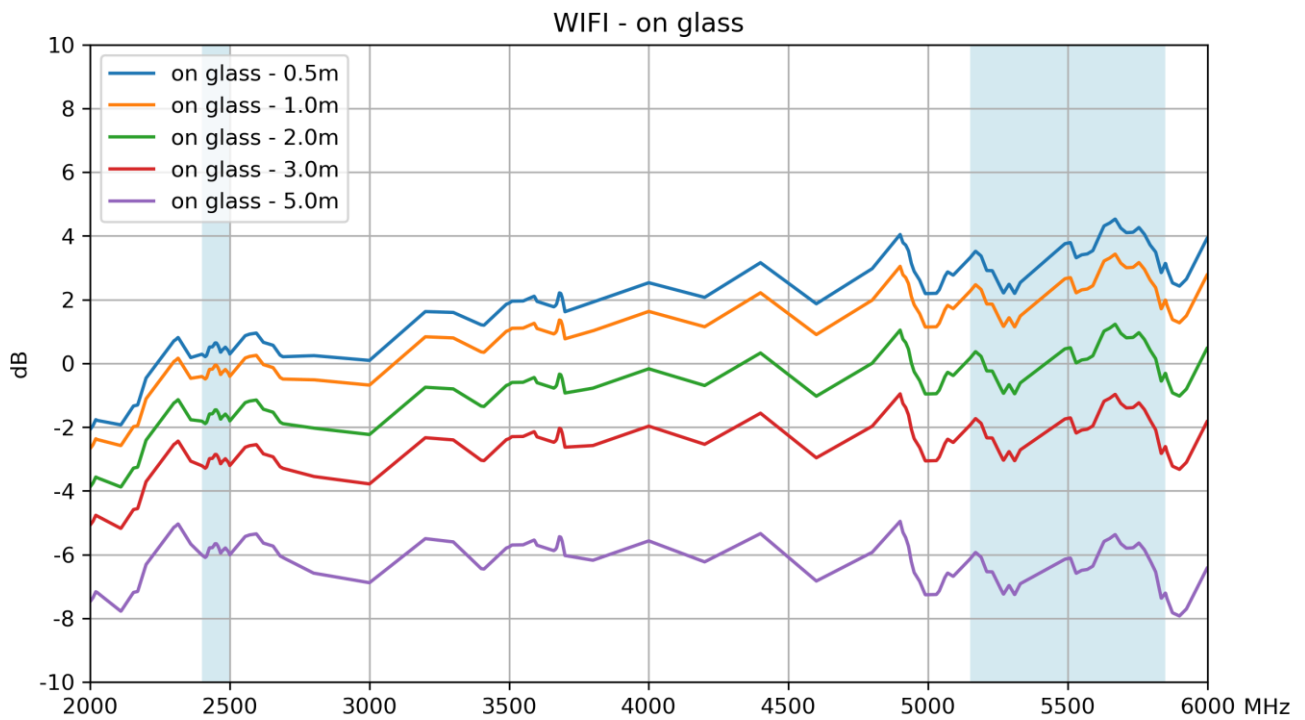

On 2mm ABS Plastic

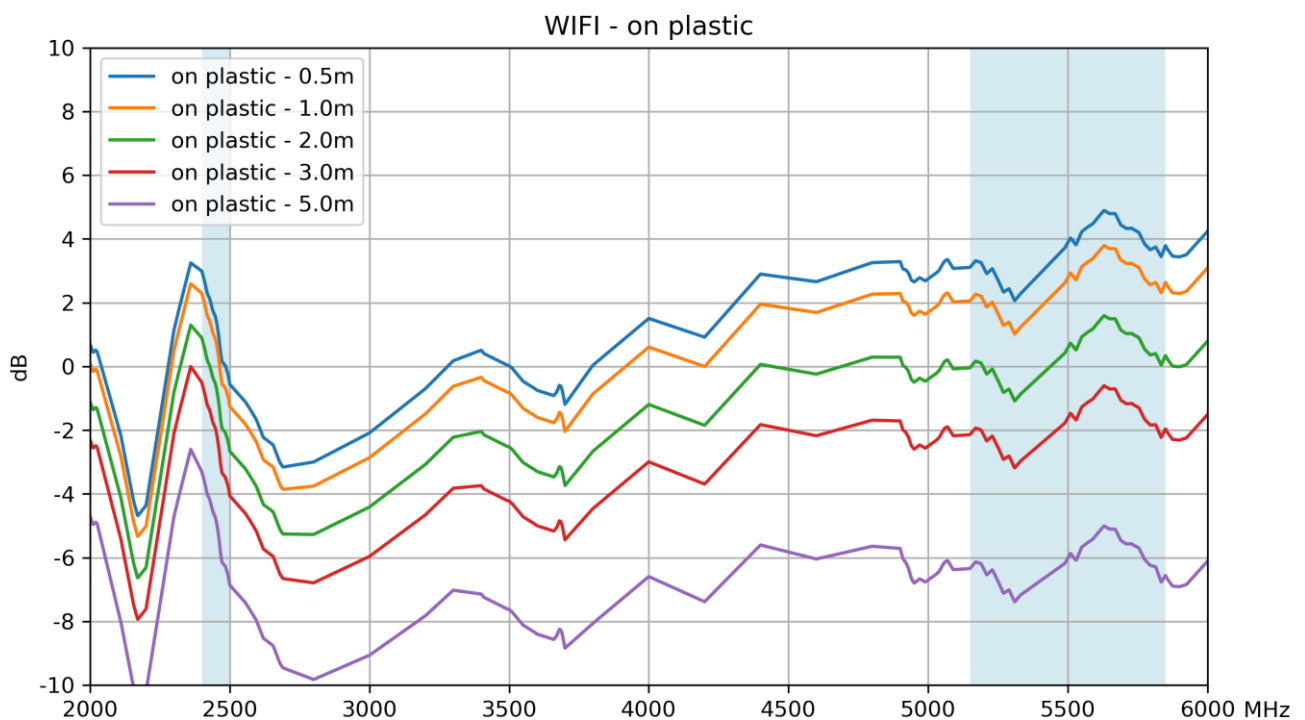

Changelog for the datasheet

SPE-13-8-045 – WA.500w.301151

Revision: J (Current Version)

Date:	2020-03-18
Changes:	Amended Data and format
Changes Made by:	Jack Conroy

Previous Revisions

Revision: I

Date:	2018-11-28
Changes:	Updated Graphs
Changes Made by:	Jack Conroy

Revision: D

Date:	2015-05-05
Changes:	Packaging Amended
Changes Made by:	Andy Mahoney

Revision: H

Date:	2018-11-13
Changes:	Updated Drawing
Changes Made by:	Jack Conroy

Revision: C

Date:	2015-03-03
Changes:	Drawing Updated
Changes Made by:	Aine Doyle

Revision: G

Date:	2017-07-05
Changes:	Updated to reflect ECN
Changes Made by:	Jack Conroy

Revision: B

Date:	2014-04-22
Changes:	Updated Waterproof Rating
Changes Made by:	Aine Doyle

Revision: F

Date:	2017-05-11
Changes:	Image Updated
Changes Made by:	Andy Mahoney

Revision: A (Original First Release)

Date:	2013-07-15
Notes:	
Author:	Aine Doyle

Revision: E

Date:	2016-08-25
Changes:	Updated Packaging and Disclaimer
Changes Made by:	Andy Mahoney

Previous Revisions (Continued)



TAOGLAS®

www.taoglas.com



X-ON Electronics

Largest Supplier of Electrical and Electronic Components

Click to view similar products for [Antennas](#) category:

Click to view products by [Taoglas](#) manufacturer:

Other Similar products are found below :

[GAN30084EU](#) [930-033-R](#) [GW17.07.0250E](#) [1513563-1](#) [EXE902SM](#) [APAMPG-117](#) [MAF94383](#) [W3908B0100](#) [W6102B0100](#) [YE572113-30RSMM](#) [108-00014-50](#) [66089-2406](#) [A09-F8NF-M](#) [A09-F5NF-M](#) [RGFRA1903041A1T](#) [W3593B0100](#) [W3921B0100](#) [SIMNA-868](#) [SIMNA-915](#) [SIMNA-433](#) [W1044](#) [W1049B090](#) [A75-001](#) [WTL2449CQ1-FRSMM](#) [CPL9C](#) [EXB148BN](#) [0600-00060](#) [TRA9020S3PBN-001](#) [GD5W-28P-NF](#) [MA9-7N](#) [GD53-25](#) [GD5W-21P-NF](#) [C37](#) [MAF94051](#) [MA9-5N](#) [EXD420PL](#) [B1322NR](#) [QWFTB120](#) [MAF94271](#) [MAF94300](#) [GPSMB301](#) [FG4403](#) [AO-AGSM-OM54](#) [5200232](#) [MIKROE-2349](#) [WCM.01.0111](#) [MIKROE-2393](#) [MIKROE-2352](#) [MIKROE-2350](#) [MAF94153](#)