

Specification

Part No.	:	WLA.01
Model	:	2.4GHz High Efficiency Loop Antenna
Description	:	2.5dBi 2400MHz to 2500MHz WLAN/WIFI/Bluetooth/Zigbee
Features	:	3.2*1.6*0.5mm Low Profile Peak gain 2.5dBi 50 Ohm Impedance RoHS Compliant



1. Introduction

The WLA.01 2.4GHz Loop antenna is a high efficiency, miniature SMD, edge mounted ceramic antenna for very small space requirements for Wi-Fi, WLAN, Zigbee, Bluetooth, and 802.11 applications. The WLA.01 uses the main PCB as its ground plane, thereby increasing Antenna Efficiency. It is tuned for different PCB sizes by simply changing the value of the matching circuit. At 3.2mm*1.6mm*0.5mm, the WLA.01 is one of the smallest antennas available worldwide. This antenna is delivered on tape and Reel.

Many module manufacturers specify peak gain limits for any antennas that are to be connected to that module. Those peak gain limits are based on free-space conditions. In practice, the peak gain of an antenna tested in free-space can degrade by at least 1 or 2dBi when put inside a device. So ideally you should go for a slightly higher peak gain antenna than mentioned on the module specification to compensate for this effect, giving you better performance.

Upon testing of any of our antennas with your device and a selection of appropriate layout, integration technique, or cable, Taoglas can make sure any of our antennas' peak gain will be below the peak gain limits. Taoglas can then issue a specification and/or report for the selected antenna in your device that will clearly show it complying with the peak gain limits, so you can be assured you are meeting regulatory requirements for that module.

For example, a module manufacturer may state that the antenna must have less than 2dBi peak gain, but you don't need to select an embedded antenna that has a peak gain of less than 2dBi in free-space. This will give you a less optimized solution. It is better to go for a slightly higher free-space peak gain of 3dBi or more if available. Once that antenna gets integrated into your device, performance will degrade below this 2dBi peak gain due to the effects of GND plane, surrounding components, and device housing. If you want to be absolutely sure, contact Taoglas and we will test. Choosing a Taoglas antenna with a higher peak gain than what is specified by the module manufacturer and enlisting our help will ensure you are getting the best performance possible without exceeding the peak gain limits.

1.1 Applications

*Bluetooth earphone systems

*Hand-held devices when Bluetooth/Wi-Fi functions are needed, e.g., Smart phone.

*IEEE802.11 b/g

*ZigBee

*Wireless PCMCIA cards or USB dongle

2. Specifications

The WLA.01 is designed to mount at the center of the edge of an evaluation board of 80 x 40mm. The antenna performance was measured with the WLA.01 mounted on the evaluation board with SMA(F) connector.

No	Parameter	Specification*
1	Center Frequency	2400-2500MHz
2	Dimensions	3.2*1.6*0.5mm
3	VSWR	2 max
4	Polarization	Linear
5	Bandwidth	100MHz min.
6	Gain	Peak 2.5dBi typ.
7	Efficiency	84% typ.
8	Impedance	50 Ω
Mechanical		
9	Dimensions	3.2*1.6*0.5mm
10	Material	Ceramic
Environmental		
11	Operating Temperature	-40°C~+85°C
12	Storage Temperature	-40°C~+105°C
13	Temperature Coefficient (τf)	0 ± 20 ppm @-20°C to +80°C
14	Recommended Reel Storage	5°C to 40°C
	Condition	Relative Humidity 20% to 70%

* The data was measured by a CTIA Authorized Test Lab.

** Center frequency will be offset to working frequency according to the conditions of user's Ground plane and radome.

3. Electrical Specification (80*40mm ground plane)

3.1 Return Loss(S11)

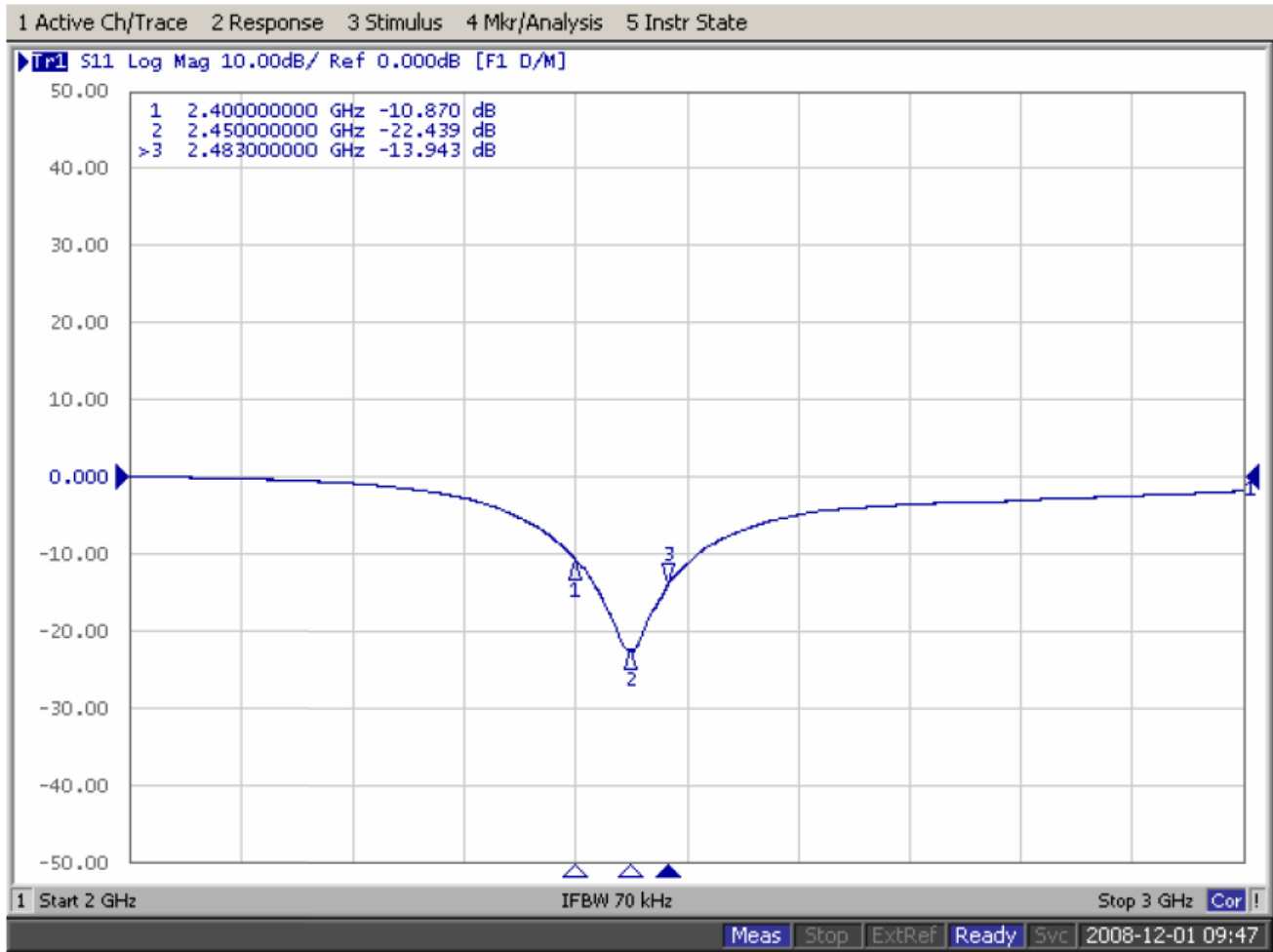

3.2 VSWR

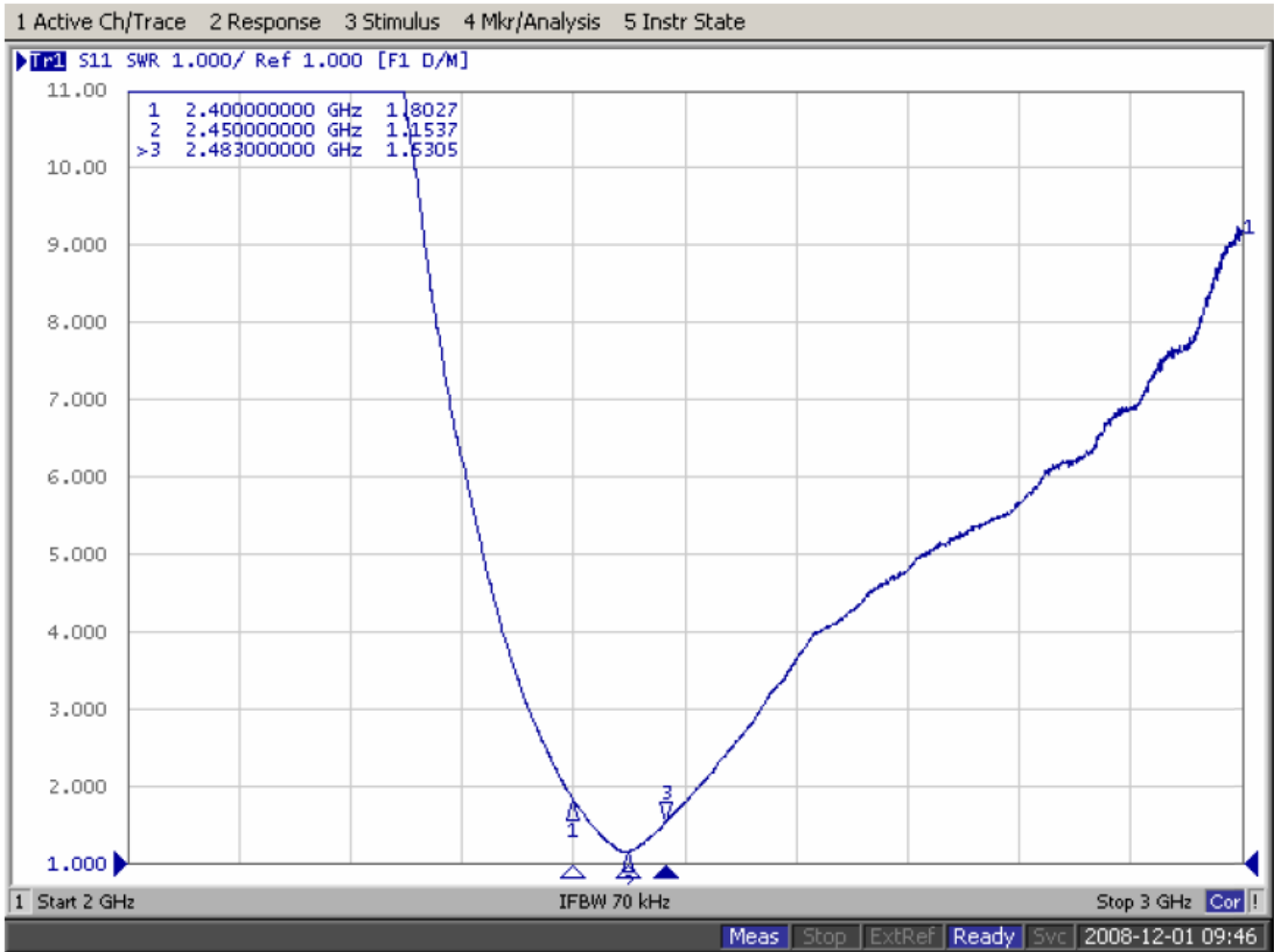

4. Radiation Pattern (Customize Design)

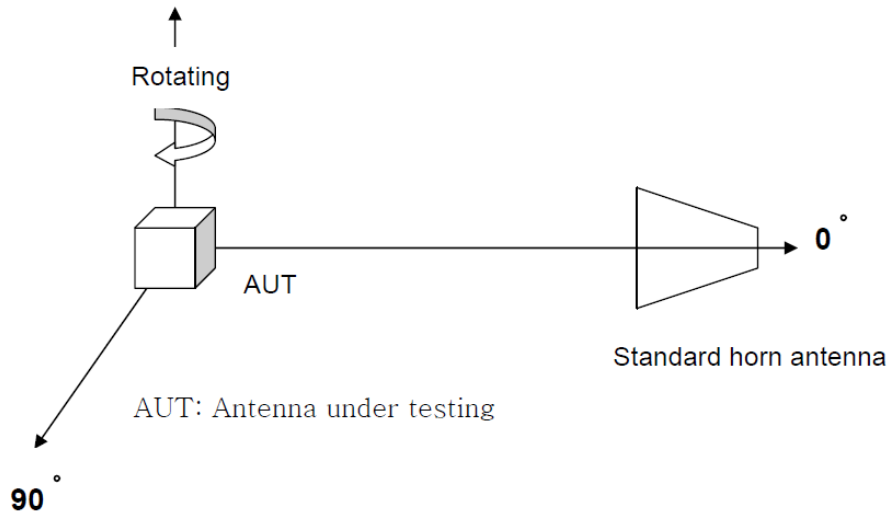

4.1 Radiation Pattern (80mmX40mm ground plane)

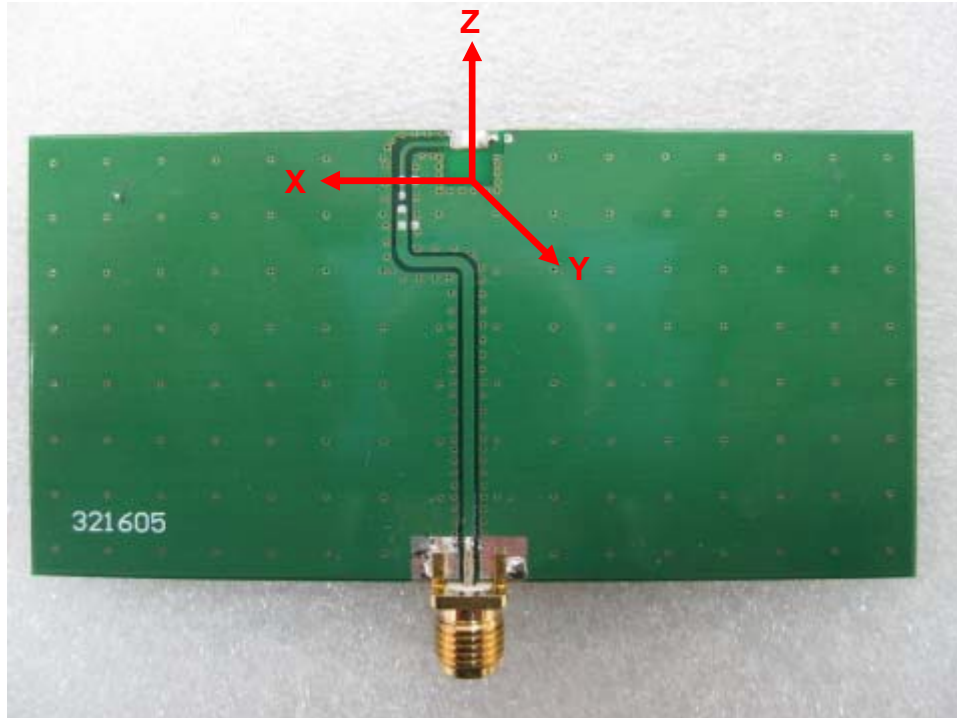

4.2 3D Gain pattern @2442MHz

Azimuth = -180.0
Elevation = 0.0
Roll = 0.0

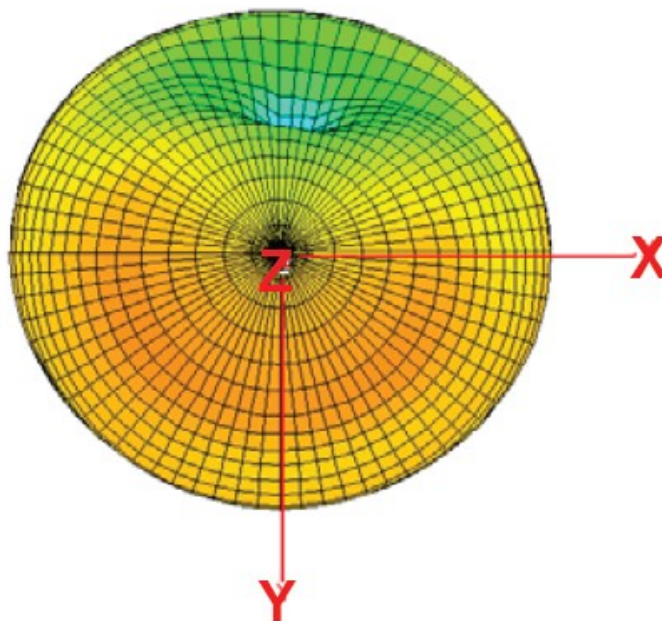

Azimuth = -180.0
Elevation = -5.1
Roll = 180.0

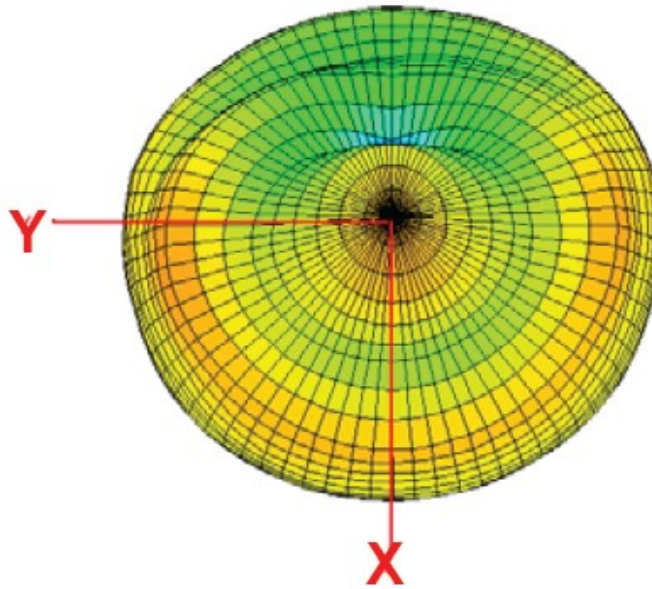

Azimuth = 0.0
Elevation = -90.0
Roll = 180.0

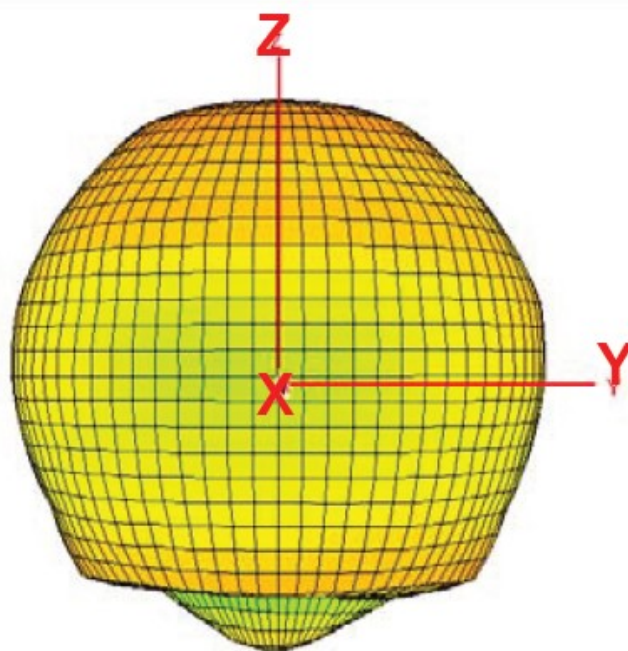

4.3 Efficiency Table

Frequency(MHz)	2400	2410	2420	2430	2442	2450	2460	2470	2480	2490	2500
Efficiency(dB)	-1.38	-1.04	-0.85	-0.74	-0.73	-0.76	-0.86	-1.05	-1.18	-1.27	-1.40
Efficiency(%)	72.83	78.71	82.27	84.39	84.53	84.04	82.00	78.60	76.14	74.64	72.50
Gain(dBi)	1.47	1.81	2.10	2.40	2.50	2.50	2.37	2.10	1.90	1.87	1.75

4.4 Efficiency vs Frequency

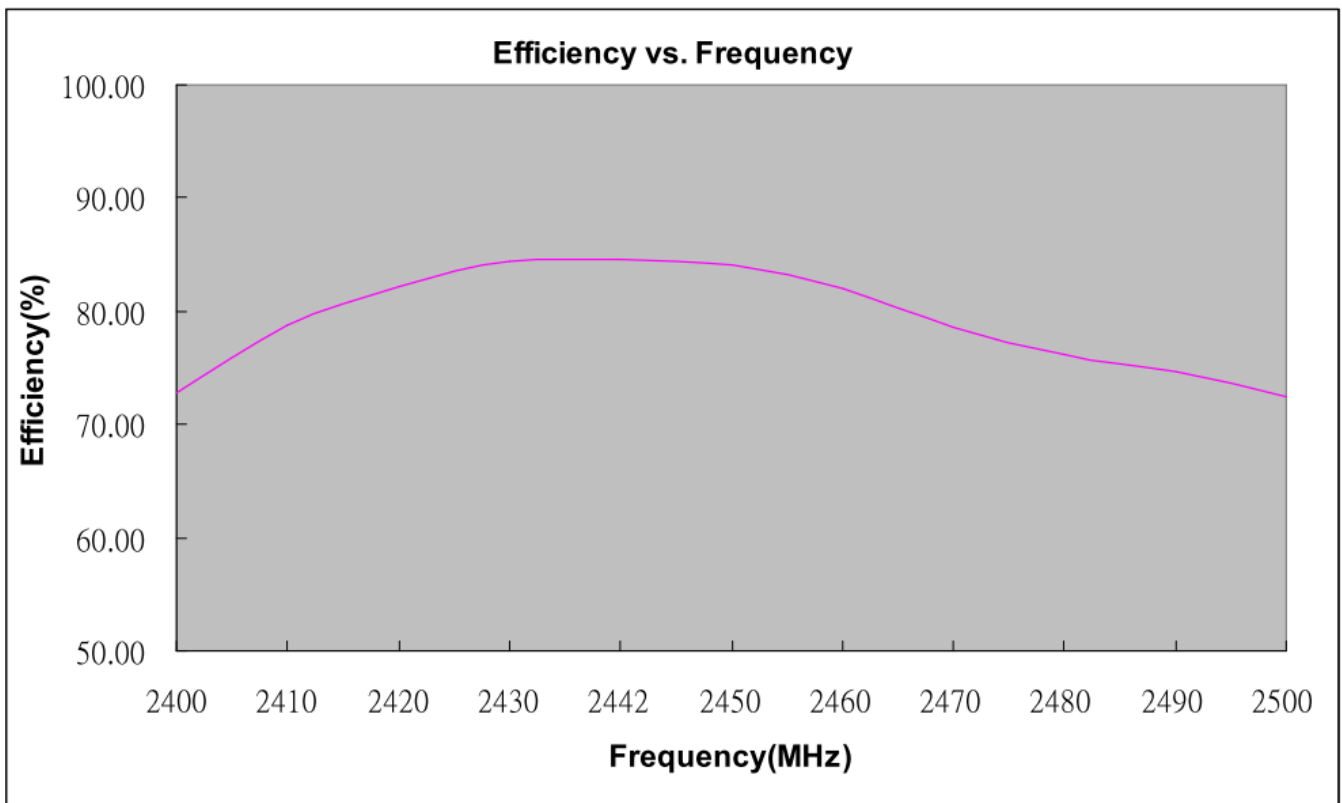



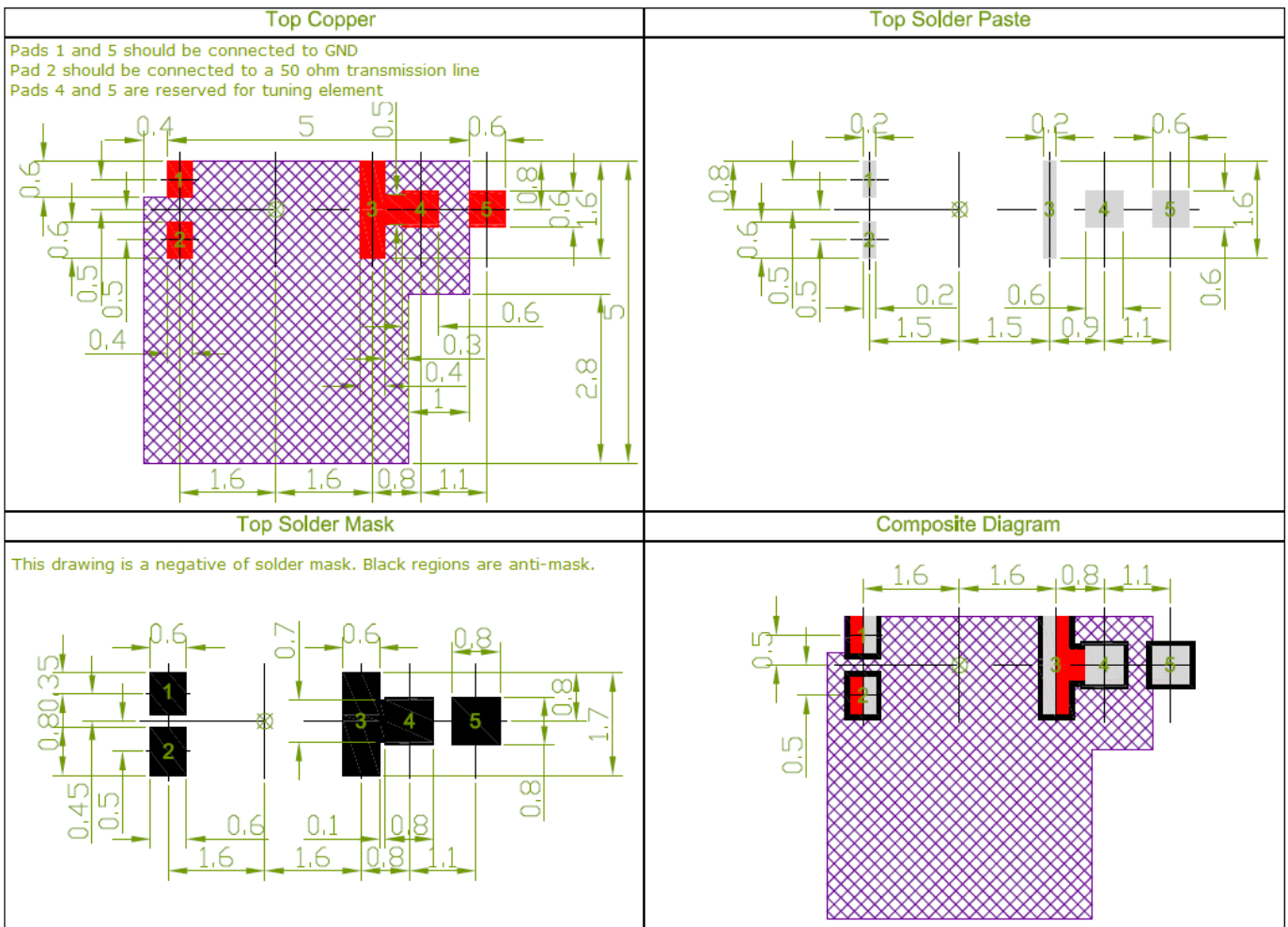

5. Layout Guide

5.1 Solder Land Pattern

Land pattern for soldering (grey marking areas) is as shown below. A matching circuit similar to the one shown in section 5.3 is also required.



NOTE:	
1. Ag Plated area	
2. Solder Mask area	
3. Copper area	
4. Paste area	
5. Keepout Region area	
6. Ground keepout should extend through all PCB layers to minimize coupling from RF feed to ground.	
7. Any vias in pads should be either filled or tented to prevent solder from wicking away from the pad during reflow.	
8. The dimension tolerances should follow standard PCB manufacturing guidelines	



5.2 Solder Land Pattern

This antenna includes a fine tuning element (as shown in the land patterns above) that can be used to slightly shift antenna resonance.

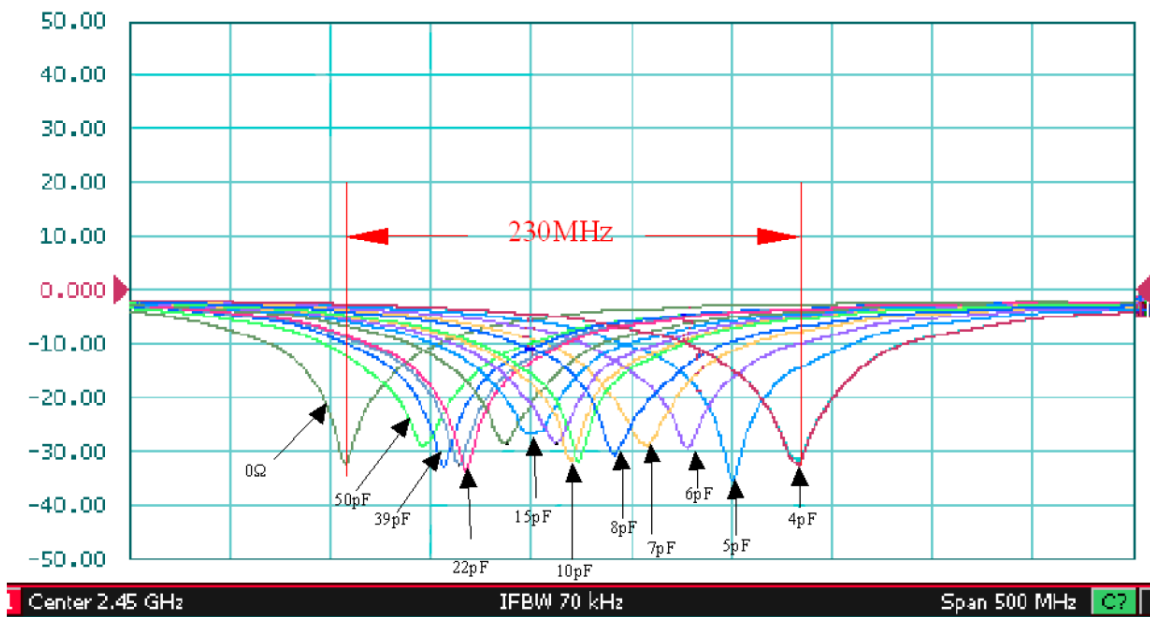

5.3 Matching Circuit

Like all antennas, surrounding components, enclosures, and changes to the GND plane dimensions can alter performance. A pi-matching network like the one shown below is required in case adjustments need to be made. The antenna EVB has a similar matching network. The components on the EVB are a good starting point for a new design, but will need to be adjusted upon integration for best performance. The zero ohm resistor is needed for the ability to solder down a coax pigtail to make measurements with a vector network analyzer.

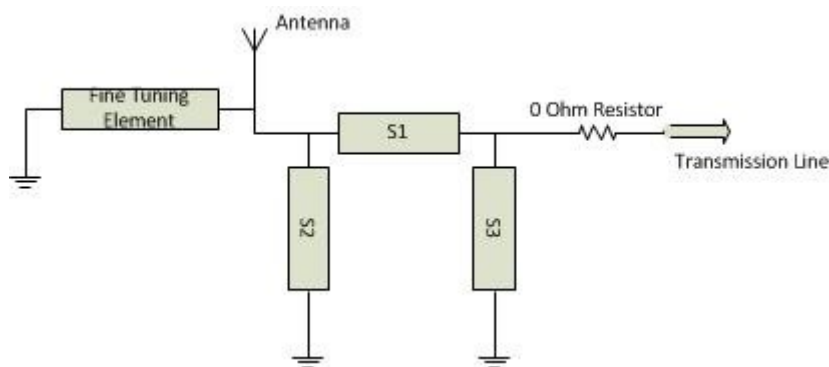

6. Antenna Drawings

6.1 Antenna Main Body

Top View

Side View

Bottom View

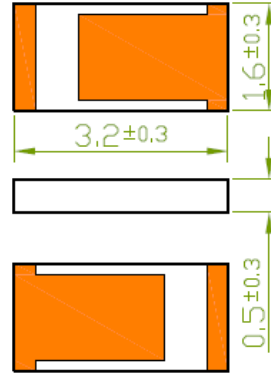

NOTE:

1. Ag Plated area



6.2 Antenna with EVB

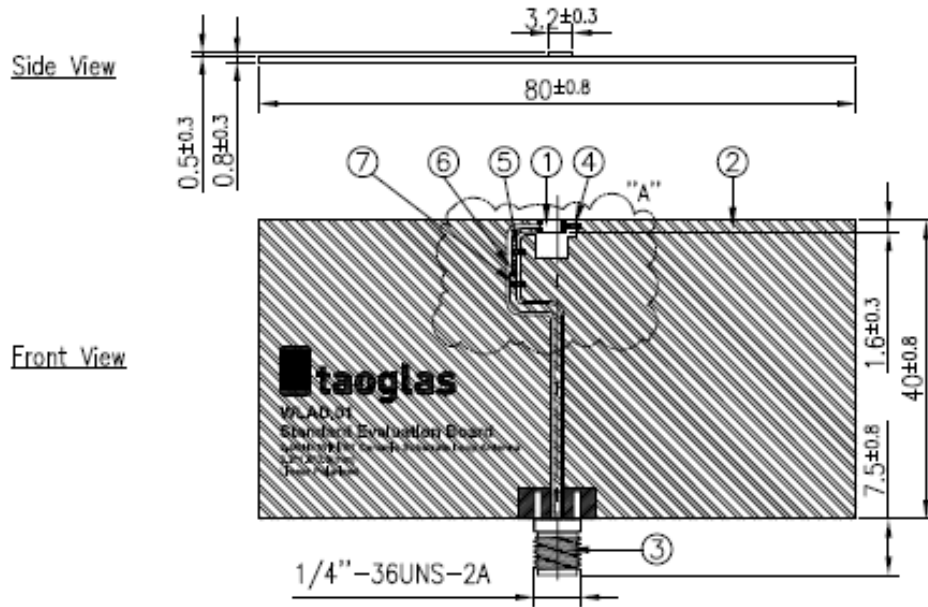

6.3 Footprint on EVB

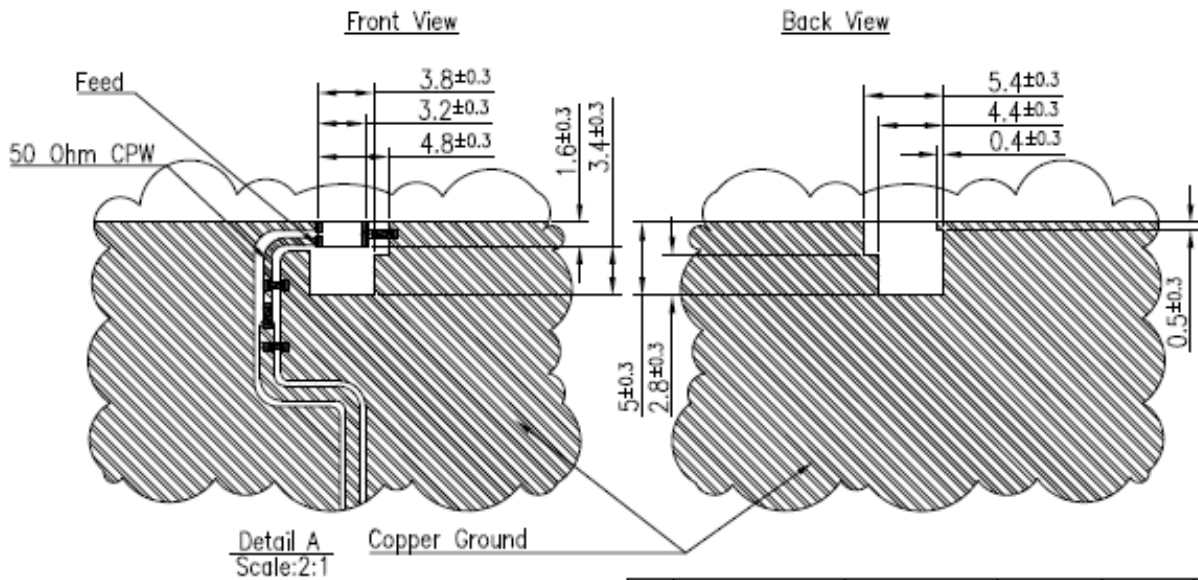

NOTES:

1. Solder Area 
2. Logo & Text Ink Printing : White
3.  Copper
4.  Matching Component

	Name	P/N	Material	Finish	QTY
1	WLAD.01 Antenna	001513H000012A	Ceramic	N/A	1
2	WLAD.01 EVB Board	100213H000012A	Composite 0.8	Black	1
3	SMA(F) ST	200413B000012A	Brass	Au Plated	1
4	Capacitor 3.9pF (0402)	001516B010012A	Ceramic	N/A	1
5	Capacitor 1.5pF (0402)	001516B070012A	Ceramic	N/A	1
6	Resistor 0Ω (0402)	001511J010012A	Ceramic	N/A	1
7	Inductor 2.2nH (0402)	001516L000012A	Ceramic	N/A	1

7. Packaging

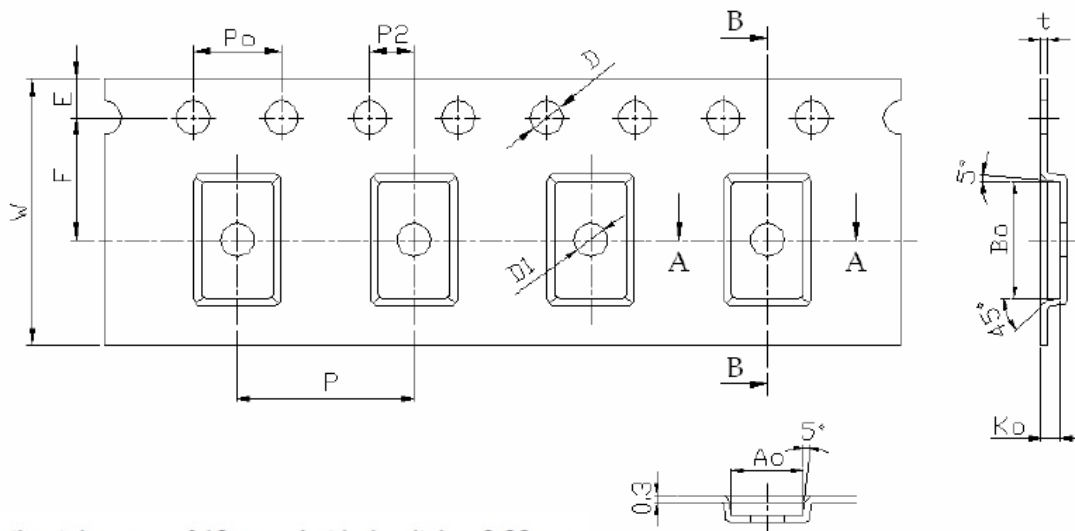
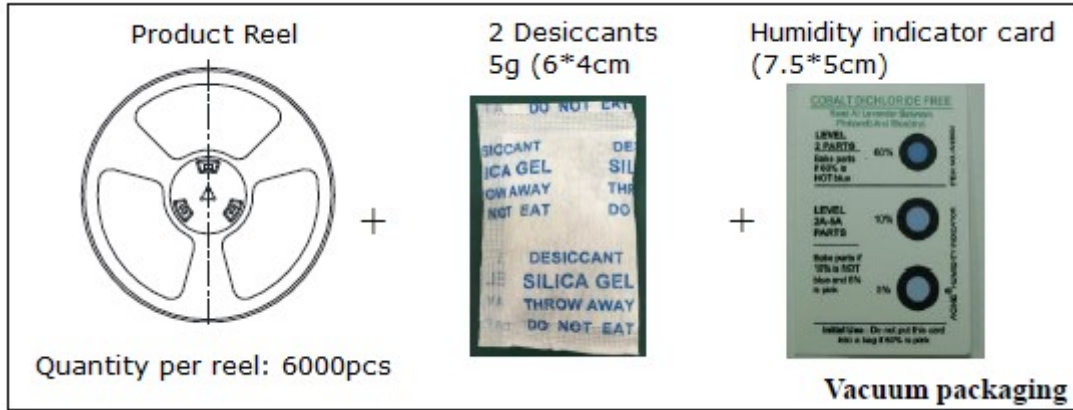

1. Cumulative tolerance of 10 sprocket hole pitch: $\pm 0.20\text{mm}$
2. Carrier camber not to exceed 1mm in 250mm
3. A_0 and B_0 measured on a plane 0.3mm above the bottom of the pocket.
4. K_0 measured from a plane on the inside bottom of the pocket to the top surface of the carrier.
5. All dimensions meet EIA-481-B requirements.
6. Material: Clear Non Anti-Static Polystyrene.
 Black Conductive Polystyrene.

7.1 Tape Dimensions (unit: mm)

Feature	Specifications	Tolerances
W	12	±0.30
P	8	±0.10
E	1.75	±0.10
F	5.5	±0.10
P2	2	±0.10
D	1.5	±0.10
Po	4	±0.10
10Po	40	±0.20

7.2 Pocket Dimensions (unit: mm)

Feature	Specifications	Tolerances
Ao	1.9	±0.10
Bo	3.5	±0.10
Ko	0.8	±0.10
t	0.3	±0.05

8. Recommended Reflow Temp Profile

The WLA.01 Loop Antenna can be assembled following either Sn-Pb or Pb-Free assembly processes. The recommended soldering temperatures are as follows:

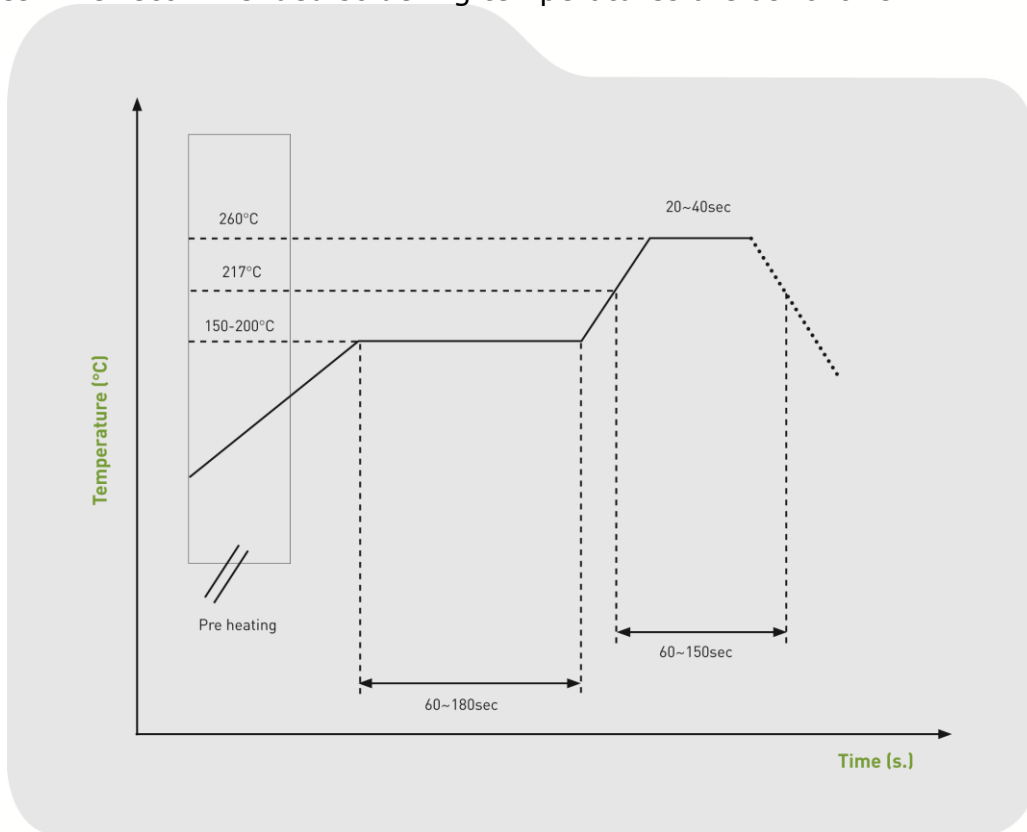

X-ON Electronics

Largest Supplier of Electrical and Electronic Components

Click to view similar products for [Antenna Development Tools](#) category:

Click to view products by [Taoglas](#) manufacturer:

Other Similar products are found below :

[0868AT43A0020-EB1SMA](#) [EVALBGSA141MN10TOBO1](#) [A10393-U1](#) [PCSD.06.A](#) [B5771-U1](#) [KIT-LTE-GNSS-01](#) [KIT-WIFI-ISM-01](#)
[A10472-U1](#) [REFLECTOR-EVB-1](#) [A10340-U1](#) [ACAG0201-2450-EVB](#) [ACAG0301-15752450-EVB](#) [ACAG0301-1575-EVB](#) [ACAG0301-24505500-EVB](#) [ACAG0301-5500-EVB](#) [ACAG0801-2450-EVB](#) [ACAG1204-433-EVB](#) [ACAG1204-868-EVB](#) [ACAG1204-915-EVB](#)
[ACAR0301-SW2-EVB](#) [ACAR3005-C2WB-EVB](#) [ACAR3005-S824-EVB](#) [ACAR3705-S698-EVB](#) [ACAR4008-S698-EVB](#) [A10137-D](#)
[A10194-U1](#) [A10204-U1](#) [A5645H-EVB-1](#) [A5645-U1](#) [A5887H-EVB-1](#) [A6111-U1](#) [M20057-EVB-1](#) [SR42W001-U1](#) [SR42W009-U1](#)
[SR4G008-U1](#) [SR4G013-U1](#) [SR4G053-EVB-1](#) [SR4L049-EVB-1](#) [SRC5G027-U1](#) [SRCW004-U1](#) [1001312-01](#) [M310220-01](#) [M620720-01](#)
[M830120-01](#) [M830520-01](#) [EB_NN01-105A](#) [EB_NN02-201-5G](#) [CCKLTE450-NA](#) [AEK-GNCP-TH258L15](#) [MPA-104- KIT](#)