



Tappex[®] Thread inserts

Precise and durable in light materials

The center of excellence for high-performance fastening technology

KVT-Fastening is an expert for high-quality fastening applications and offers engineering solutions based on the wide product portfolio of the leading manufacturers in the market.



Mechanical engineering | Automotive | Electrical engineering | Energy | Precision engineering | Fluid power | Transportation | Off-shore and Marine | Medical equipment
Aviation and aerospace | Construction industry | Watch manufacturing industry

www.kvt-fastening.com



High-performance solutions from KVT-Fastening are found wherever absolutely safe and secure connections are essential. These small but extremely resilient components play key roles where it matters most – whether in the electronics and energy sector, the automotive and transportation industries, aviation and aerospace, engineering and construction, precision engineering, or medical equipment.

KVT-Fastening does not just supply standard products and individual components, but also provides close and active customer support in the search for ideal solutions, particularly when specific requirements must be fulfilled. This portfolio is complemented by a range of innovative tools and

machines as well as, if needed, the integration into automated serial production workflows.

Ever since 1927, KVT-Fastening has stood for experience, solution-driven know-how, unique expertise in development and consultancy as well as the ultimate in reliability. Since December 2012, KVT-Fastening is a member of the Bossard Group. Bossard is a leading provider of intelligent solutions for industrial fastening technology. The range includes global sales, technical consulting (engineering) and logistics of fastening technology components and bolts. Customers benefit from the extension of competencies in industrial fastening technology and from an optimally enhanced product or service portfolio.



Tappex® – reliable and cost-efficient thread inserts

Tappex® brass thread inserts (steel or stain-less steel) create precise, durable internal threads in workpieces made of plastic, light metal alloy, and other notch-sensitive materials.

- **TRISERT® self-tapping inserts** reinforced plastics (GRP) and thermoset plastics. In moulded and drilled holes the three cutting flutes ensure secure embedding in the base material. Available in brass in sizes M2 – M10 with and without a head, TRISERT® guarantees a clean, swarf-free internal thread. The particular advantage of the double ended thread insert is that it can be installed bidirectional.
- **TRISERT-3® self-tapping inserts**, a sub-group of TRISERT® thread inserts, made of steel or stain-less steel, meet the strictest of requirements, e.g. in medical technology, the maritime sector, or in the food industry.
- **FOAMSERT® self-tapping inserts**. This subgroup of TRISERT® thread insert is used in drilled holes in expanded materials and wood. A hand installation tool and a pneumatic tool, each with their own accessories, are available for installation TRISERT®, TRISERT-3® and FOAMSERT®.

- **MULTISERT® press-fitting inserts** with internal thread and patented barb form section are particularly suitable for use with thermoplastic materials. They are available in sizes M1.6 – M12 both with and without a head. Processing methods: press-fitting, ultrasonic insertion, heat insertion (local melting of plastic).
- **MICROBARB® press-fitting inserts with micro knurling**. This sub-group of MULTISERT® thread inserts is ideal for use in thin-walled materials. Both MULTISERTS® and MICROBARBS® can be installed using the Heat Inserter 074/02.
- **HiMOULD® brass threaded inserts for molding** in M2 – M12 are used in moulded and cast components. The HiMOULD® insert can be molded in very close the edge of a component or in situations where there are thin walls or bosses which would be impractical for post-mold installed inserts. Exceptionally wide range of applications for thermoplastic and thermoset plastic molded parts with open ended or blind ended design.

The following applies to all Tappex® variants:
With non-chamfered threads, a small burr is possible at the end of the thread.



Contents

TRISERT® Self-tapping inserts	6 – 10
TRISERT-3® Self-tapping inserts, steel and stainless steel	11 – 13
FOAMSERT® Self-tapping inserts	14
Installation equipment for TRISERT®, TRISERT-3® and FOAMSERT®	15
MULTISERT® Press-fitting inserts	16 – 19
MICROBARB® Press-fitting inserts with micro knurling	20
Thermal pressing device for MULTISERT® and MICROBARB® thread inserts	21
HiMOULD® Inserts for molding in	22 – 24
Technical data	26 – 28
Test procedures	29

Technical performances, installation recommendations as well as unspecified tolerances regarding the dimensions of the parts have to be requested individual for each application before starting the series production.

All dimensions are specified in mm.

Thread inserts

TRISERT®



- Double ended bidirectional purpose
- Self-tapping thread insert
- For thermoplastic materials
- 3 special cutting flutes prevent swarf in the internal thread
- Can be used in drilled or molded holes
- Fully internal through threaded

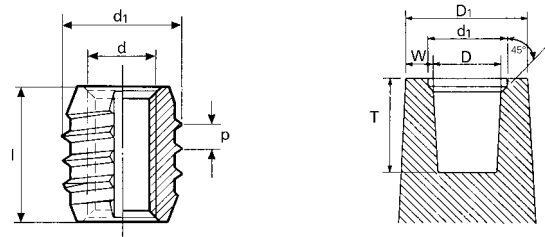

Material

Brass

Typical applications

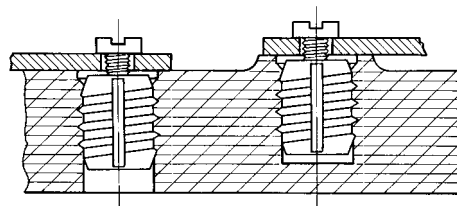

3-D Data: <http://kvt.partcommunity.com>

Order reference	Thread insert					Location hole*			
	d	l	d ₁ nom.	p nom.	D	W min.	D ₁ min.	T min.	
145M2 136M2	M2	4.00 4.80	±0.20	3.50 3.50	0.79 0.79	3.1- 3.3 3.1- 3.3	1.25 1.25	5.8 5.8	4.4 5.3
145M2,5 136M2,5 137M2,5	M2.5	4.00 5.25 6.25	±0.20	4.33 4.33 4.33	1.06 1.06 1.06	3.8 - 4.1 3.8 - 4.1 3.8 - 4.1	1.55 1.55 1.55	7.2 7.2 7.2	4.4 5.8 6.9
145M3 136M3 137M3	M3	4.00 5.25 6.25	±0.20	4.73 4.73 4.73	1.06 1.06 1.06	4.1- 4.4 4.1- 4.4 4.1- 4.4	1.65 1.65 1.65	7.7 7.7 7.7	4.4 5.8 6.9
145M3,5 136M3,5 137M3,5	M3.5	5.00 6.20 7.30	±0.20	5.52 5.52 5.52	1.15 1.15 1.15	5.0 - 5.3 5.0 - 5.3 5.0 - 5.3	2.00 2.00 2.00	9.3 9.3 9.3	5.5 6.9 8.1
145M4 136M4 137M4	M4	5.60 7.10 8.40	±0.20	6.31 6.31 6.31	1.27 1.27 1.27	5.8 - 6.1 5.8 - 6.1 5.8 - 6.1	2.30 2.30 2.30	10.7 10.7 10.7	6.2 7.9 9.3
145M5 136M5 137M5	M5	6.40 8.40 10.00	±0.25	7.50 7.50 7.50	1.41 1.41 1.41	6.9 - 7.2 6.9 - 7.2 6.9 - 7.2	2.70 2.70 2.70	12.6 12.6 12.6	7.1 9.3 11.0
145M6 136M6 137M6	M6	7.90 9.80 12.00	±0.25	8.69 8.69 8.69	1.59 1.59 1.59	8.0 - 8.4 8.0 - 8.4 8.0 - 8.4	3.15 3.15 3.15	14.7 14.7 14.7	8.7 10.8 13.2
145M8-21 145M8 136M8	M8	8.00 9.50 12.40	±0.30	11.06 11.06 11.06	1.95 1.95 1.95	10.1 - 10.6 10.1 - 10.6 10.1 - 10.6	4.00 4.00 4.00	18.6 18.6 18.6	8.8 10.5 13.7
145M10 136M10	M10	12.00 16.00	±0.30	13.95 13.95	1.95 1.95	13.0 - 13.5 13.0 - 13.5	5.10 5.10	23.7 23.7	13.2 17.6

* Installation data: Please note that the dimensions quoted represent standard values and may vary depending on the material of the molded part. It is advisable to run trials prior to series production.

Thread inserts

TRISERT®



- Double ended bidirectional purpose
- Self-tapping thread insert
- For thermoset plastics, glass-fiber reinforced plastics (GRP) > 35%
- 3 special cutting flutes prevent swarf in the internal thread
- Can be used in drilled or molded holes
- Fully internal through threaded
- Design of cutting flutes modified for use in thermoset plastics

Material

Brass

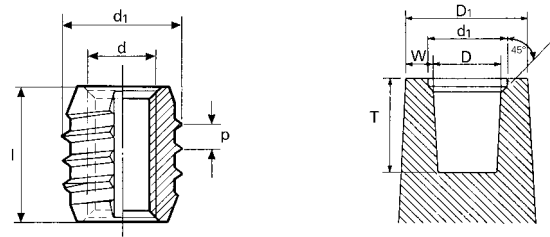

Typical applications

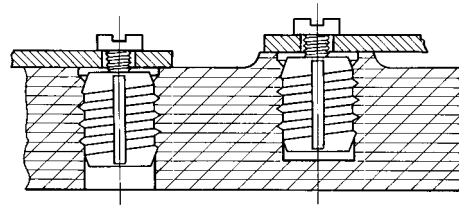

3-D Data: <http://kvt.partcommunity.com>

Order reference	Thread insert				Location hole			
	d	l ± 0.125	d1 nom.	p nom.	D	W min.	D1 min.	T min.
139M2 138M2	M2	4.00 4.80	3.50 3.50	0.79 0.79	Upon request			
139M2,5 138M2,5 170M2,5	M2.5	4.00 5.25 6.25	4.33 4.33 4.33	1.06 1.06 1.06				
139M3 138M3 170M3	M3	4.00 5.25 6.25	4.73 4.73 4.73	1.06 1.06 1.06				
139M3,5 138M3,5 170M3,5	M3.5	5.00 6.20 7.30	5.52 5.52 5.52	1.15 1.15 1.15				
139M4 138M4 170M4	M4	5.60 7.10 8.40	6.31 6.31 6.31	1.27 1.27 1.27				
139M5 138M5 170M5	M5	6.40 8.40 10.00	7.50 7.50 7.50	1.41 1.41 1.41				
139M6 138M6 170M6	M6	7.90 9.80 12.00	8.69 8.69 8.69	1.59 1.59 1.59				
139M8 138M8	M8	9.50 12.40	11.06 11.06	1.95 1.95				
139M10 138M10	M10	12.00 16.00	13.95 13.95	1.95 1.95				

Thread inserts

TRISERT®



- **Reduced head**
- **Self-tapping** thread insert
- **For thermoplastic materials oder thermoset plastics**
- 3 special cutting flutes prevent swarf in the internal thread
- Can be used in drilled or molded holes
- Fully internal through threaded
- Larger contact surface
- Higher torque performances
- Higher axial forces
- Design of cutting flutes modified for use in thermoset plastics

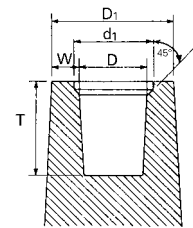
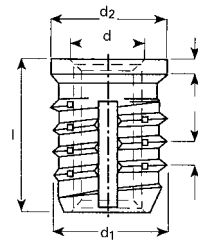

Material

Brass

3-D Data: <http://kvt.partcommunity.com>

For thermoplastic materials

Order reference	Thread insert							Location hole*			
	d	l		d ₁ nom.	p nom.	d ₂ nom.	t ± 0.15	D	W min.	D ₁ min.	T min.
237M3	M3	6.25	±0.20	4.73	1.06	4.7	0.75	4.1 – 4.4	1.65	7.7	6.9
237M4	M4	8.40	±0.20	6.31	1.27	6.3	0.80	5.8 – 6.1	2.30	10.7	9.3
237M5	M5	10.00	±0.25	7.50	1.41	7.5	0.80	6.9 – 7.2	2.70	12.6	11.0
237M6	M6	12.00	±0.25	8.69	1.59	8.6	0.90	8.0 – 8.4	3.15	14.7	13.2
245M6	M6	7.90		8.69	1.59	8.6	0.90	8.0 – 8.4	3.15	14.7	8.7
237M8	M8	14.00	±0.30	11.06	1.95	11.1	1.00	10.1 – 10.6	4.00	18.6	15.6

For thermoset plastics

Order reference	Thread insert							Location hole*			
	d	l ± 0.125	d ₁ nom.	p nom.	d ₂ nom.	t ± 0.15	D	W min.	D ₁ min.	T min.	
270M3	M3	6.25	4.73	1.06	4.7	0.75	Upon request				
270M4	M4	8.40	6.31	1.27	6.3	0.80					
270M5	M5	10.00	7.50	1.41	7.5	0.80					
270M6	M6	12.00	8.69	1.59	8.6	0.90					
239M6	M6	7.90	8.69	1.59	8.6	0.90					
270M8	M8	14.00	11.06	1.95	11.1	1.00					

* Installation data: Please note that the dimensions quoted represent standard values and may vary depending on the material of the molded part. It is advisable to run trials prior to series production.

Thread inserts

TRISERT®



- Regular head
- Self-tapping thread insert
- For thermoplastic materials
- 3 special cutting flutes prevent swarf in the internal thread
- Can be used in drilled or molded holes
- Fully internal through threaded
- Larger contact surface
- Higher torque performances
- Higher axial forces

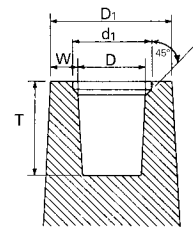
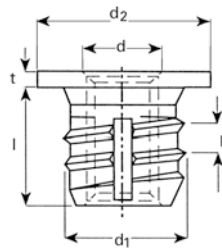

Material

Brass

3-D Data: <http://kvt.partcommunity.com>

Order reference	Thread insert							Location hole*			
	d	l		d ₁ nom.	p nom.	d ₂ nom.	t ±0.15	D	W min.	D ₁ min.	T min.
345M2,5 336M2,5	M2.5	4.00	±0.20	4.33	1.06	6.35	0.60	3.8 – 4.1	1.55	7.2	4.4
	M2.5	5.25		4.33	1.06	6.35	0.60	3.8 – 4.1	1.55	7.2	5.8
345M3 336M3	M3	4.00	±0.20	4.73	1.06	7.10	0.75	4.1 – 4.4	1.65	7.7	4.4
	M3	5.25		4.73	1.06	7.10	0.75	4.1 – 4.4	1.65	7.7	5.8
345M3,5 336M3,5	M3.5	5.00	±0.20	5.52	1.15	8.30	0.75	5.0 – 5.3	2.00	9.3	5.5
	M3.5	6.20		5.52	1.15	8.30	0.75	5.0 – 5.3	2.00	9.3	6.9
345M4 336M4	M4	5.60	±0.20	6.31	1.27	8.70	0.75	5.8 – 6.1	2.30	10.7	6.2
	M4	7.10		6.31	1.27	8.70	0.75	5.8 – 6.1	2.30	10.7	7.9
345M5 336M5	M5	6.40	±0.25	7.50	1.41	11.10	0.90	6.9 – 7.2	2.70	12.6	7.1
	M5	8.40		7.50	1.41	11.10	0.90	6.9 – 7.2	2.70	12.6	9.3
345M6 336M6	M6	7.90	±0.25	8.69	1.59	12.00	1.00	8.0 – 8.4	3.15	14.7	8.7
	M6	9.80		8.69	1.59	12.00	1.00	8.0 – 8.4	3.15	14.7	10.8
345M8-02 336M8	M8	7.50	±0.30	11.06	1.95	14.30	1.25	10.1 – 10.6	4.00	18.6	8.3
	M8	12.40		11.06	1.95	14.30	1.25	10.1 – 10.6	4.00	18.6	13.7
345M10 336M10	M10	12.00	±0.30	13.95	1.95	18.00	1.50	13.0 – 13.5	5.10	23.7	13.2
	M10	16.00		13.95	1.95	18.00	1.50	13.0 – 13.5	5.10	23.7	17.6

* Installation data: Please note that the dimensions quoted represent standard values and may vary depending on the material of the molded part. It is advisable to run trials prior to series production.

Thread inserts

TRISERT®



- Regular head
- Self-tapping thread insert
- For thermoset plastics
- 3 special cutting flutes prevent swarf in the internal thread
- Can be used in drilled or molded holes
- Fully internal through threaded
- Larger contact surface
- Higher torque performances
- Higher axial forces
- Design of cutting flutes modified for use in thermoset plastics

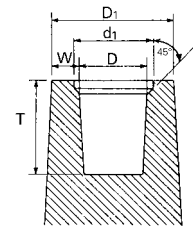
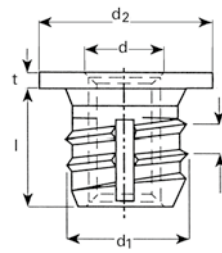

Material

Brass

3-D Data: <http://kvt.partcommunity.com>

Order reference	Thread insert							Location hole			
	d	l		d ₁ nom.	p nom.	d ₂ nom.	t ±0.15	D	W min.	D ₁ min.	T min.
339M2,5 338M2,5	M2.5	4.00	±0.20	4.33	1.06	6.35	0.60	Upon request			
	M2.5	5.25		4.33	1.06	6.35	0.60				
339M3 338M3	M3	4.00	±0.20	4.73	1.06	7.10	0.75				
	M3	5.25		4.73	1.06	7.10	0.75				
339M3,5 338M3,5	M3.5	5.00	±0.20	5.52	1.15	8.30	0.75				
	M3.5	6.20		5.52	1.15	8.30	0.75				
339M4 338M4	M4	5.60	±0.20	6.31	1.27	8.70	0.75				
	M4	7.10		6.31	1.27	8.70	0.75				
339M5 338M5	M5	6.40	±0.25	7.50	1.41	11.10	0.90				
	M5	8.40		7.50	1.41	11.10	0.90				
339M6 338M6	M6	7.90	±0.25	8.69	1.59	12.00	1.00				
	M6	9.80		8.69	1.59	12.00	1.00				
339M8-02 338M8	M8	7.50	±0.30	11.06	1.95	14.30	1.25				
	M8	12.40		11.06	1.95	14.30	1.25				
339M10 338M10	M10	12.00	±0.30	13.95	1.95	18.00	1.50				
	M10	16.00		13.95	1.95	18.00	1.50				

Thread inserts

TRISERT-3®



- **Reduced head**
- **Self-tapping** thread insert
- **For light metal and plastics**
- Can be used in drilled or molded holes
- Fully internal through threaded
- Case hardening steel Zn/Ni with surface coating, passivated (Cr VI+-free)
- Faster installation due to greater helix angle of the thread flanks
- Corrosion resistance up to 720 hours to red rust

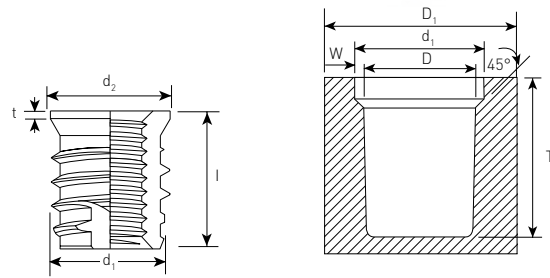

Material

Steel

3-D Data: <http://kvt.partcommunity.com>

Order reference	Thread insert					Location hole*				
	d	l ± 0.125	d ₁ nom.	d ₂ nom.	t ± 0.1	D Plastics	D Metals	W min.	D ₁ min.	T min.
6238 M3 6270 M3	M3 M3	5.25 6.25	4.73 4.73	4.70 4.70	0.38 0.38	4.10 – 4.40 4.10 – 4.40	4.35 – 4.55 4.35 – 4.55	1.65 1.65	7.70 7.70	5.80 6.90
6238 M4 6270 M4	M4 M4	7.10 8.40	6.31 6.31	6.30 6.30	0.38 0.38	5.80 – 6.10 5.80 – 6.10	5.95 – 6.15 5.95 – 6.15	2.30 2.30	10.70 10.70	7.90 9.30
6238 M5 6270 M5	M5 M5	8.40 10.00	7.50 7.50	7.50 7.50	0.40 0.40	6.90 – 7.20 6.90 – 7.20	7.15 – 7.35 7.15 – 7.35	2.70 2.70	12.60 12.60	9.30 11.00
6238 M6 6270 M6	M6 M6	9.80 12.00	8.69 8.69	8.60 8.60	0.45 0.45	8.00 – 8.40 8.00 – 8.40	8.35 – 8.55 8.35 – 8.55	3.15 3.15	14.70 14.70	10.80 13.20
6238 M8 6270 M8	M8 M8	12.40 14.00	11.06 11.06	11.10 11.10	0.50 0.50	10.10 – 10.60 10.10 – 10.60	10.55 – 10.85 10.55 – 10.85	4.00 4.00	18.60 18.60	13.70 15.40
6239 M10 6238 M10 6270 M10	M10 M10 M10	12.00 16.00 18.00	13.95 13.95 13.95	14.10 14.10 14.10	0.75 0.75 0.75	13.00 – 13.50 13.00 – 13.50 13.00 – 13.50	13.45 – 13.65 13.45 – 13.65 13.45 – 13.65	5.10 5.10 5.10	23.70 23.70 23.70	13.20 17.60 19.80

* Installation data: Please note that the dimensions quoted represent standard values and may vary depending on the material of the molded part. It is advisable to run trials prior to series production.

Thread inserts

TRISERT-3®



- **Reduced head**
- **Self-tapping** thread insert
- For **light metal** and **plastics**
- M10 also available in blind-ended design
- Can be used in drilled or molded holes
- Fully internal through threaded
- Faster installation due to greater helix angle of the thread flanks
- Stainless steel 303 comparable with 1.4305

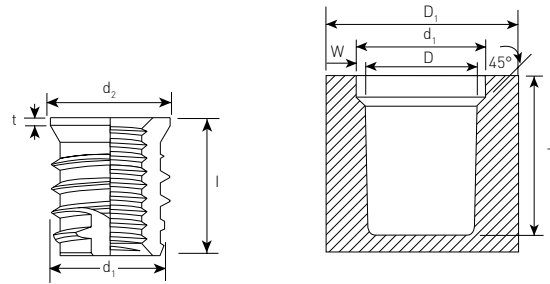

Material

Stainless steel

3-D Data: <http://kvt.partcommunity.com>

Order reference	Thread insert					Location hole*				
	d	l ±0.125	d ₁ nom.	d ₂ nom.	t ±0.1	D Plastics	D Metals	W min.	D ₁ min.	T min.
6238 M3-303 6270 M3-303	M3	5.25 6.25	4.73	4.70	0.38	4.10 – 4.40	4.35 – 4.55	1.65	7.70	5.80 6.90
6238 M4-303 6270 M4-303	M4	7.10 8.40	6.31	6.30	0.38	5.80 – 6.10	5.95 – 6.15	2.30	10.70	7.90 9.30
6238 M5-303 6270 M5-303	M5	8.40 10.00	7.50	7.50	0.40	6.90 – 7.20	7.15 – 7.35	2.70	12.60	9.30 11.00
6238 M6-303 6270 M6-303	M6	9.80 12.00	8.69	8.60	0.45	8.00 – 8.40	8.35 – 8.55	3.15	14.70	10.80 13.20
6238 M8-303 6270 M8-303	M8	12.40 14.00	11.06	11.10	0.50	10.10 – 10.60	10.55 – 10.85	4.00	18.60	13.70 15.40
6239 M10-303 6238 M10-303 6270 M10-303	M10	12.00 16.00 18.00	13.95	14.10	0.75	13.00 – 13.50	13.45 – 13.65	5.10	23.70	13.20 17.60 19.80
6239 M12-303 6238 M12-303 6270 M12-303	M12	13.50 18.00 20.00	15.95	16.10	0.75	15.00 – 15.50	15.45 – 15.65	5.95	27.40	14.85 19.80 22.00

Blind ended

Order reference	Thread insert					Location hole*				
	d	l ±0.125	d ₁ nom.	d ₂ nom.	t ±0.1	D Plastics	D Metals	W min.	D ₁ min.	T min.
6238 M10B-303 6270 M10B-303	M10	16.00 18.00	13.95	14.10	0.75	13.00 – 13.50	13.45 – 13.65	5.10	23.70	17.60 19.80

* Installation data: Please note that the dimensions quoted represent standard values and may vary depending on the material of the molded part. It is advisable to run trials prior to series production.

Thread inserts

TRISERT-3®

- **Reduced head**
- **Self-tapping** thread insert
- For **light metal** and **plastics**
- M10 also available in blind-ended design
- Can be used in drilled or molded holes
- Fully internal through threaded
- Faster installation due to greater helix angle of the thread flanks
- Stainless steel 316 comparable with 1.4401

Material

Stainless steel

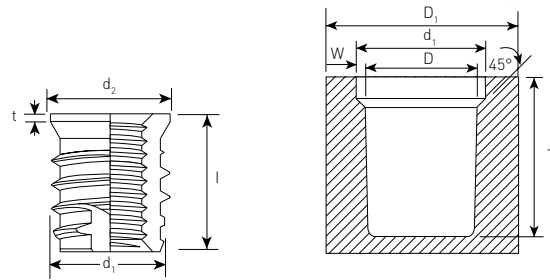

3-D Data: <http://kvt.partcommunity.com>

Order reference	Thread insert					Location hole*				
	d	l ±0.125	d ₁ nom.	d ₂ nom.	t ±0.1	D Plastics	D Metals	W min.	D ₁ min.	T min.
6238 M3-316 6270 M3-316	M3	5.25 6.25	4.73	4.70	0.38	4.10 – 4.40	4.35 – 4.55	1.65	7.70	5.80 6.90
6238 M4-316 6270 M4-316	M4	7.10 8.40	6.31	6.30	0.38	5.80 – 6.10	5.95 – 6.15	2.30	10.70	7.90 9.30
6238 M5-316 6270 M5-316	M5	8.40 10.00	7.50	7.50	0.40	6.90 – 7.20	7.15 – 7.35	2.70	12.60	9.30 11.00
6238 M6-316 6270 M6-316	M6	9.80 12.00	8.69	8.60	0.45	8.00 – 8.40	8.35 – 8.55	3.15	14.70	10.80 13.20
6238 M8-316 6270 M8-316	M8	12.40 14.00	11.06	11.10	0.50	10.10 – 10.60	10.55 – 10.85	4.00	18.60	13.70 15.40
6239 M10-316 6238 M10-316 6270 M10-316	M10	12.00 16.00 18.00	13.95	14.10	0.75	13.00 – 13.50	13.45 – 13.65	5.10	23.70	13.20 17.60 19.80
6239 M12-316 6238 M12-316 6270 M12-316	M12	13.50 18.00 20.00	15.95	16.10	0.75	15.00 – 15.50	15.45 – 15.65	5.95	27.40	14.85 19.80 22.00

Blind ended

Order reference	Thread insert					Location hole*				
	d	l ±0.125	d ₁ nom.	d ₂ nom.	t ±0.1	D Plastics	D Metals	W min.	D ₁ min.	T min.
6238 M10B-316 6270 M10B-316	M10	16.00 18.00	13.95	14.10	0.75	13.00 – 13.50	13.45 – 13.65	5.10	23.70	17.60 19.80

* Installation data: Please note that the dimensions quoted represent standard values and may vary depending on the material of the molded part. It is advisable to run trials prior to series production.

Thread inserts

FOAMSERT®



- Double ended bidirectional purpose or reduced head
- Self-tapping thread insert
- Designed especially for expanded material and wood
- 3 special cutting flutes prevent swarf in the internal thread
- Can be used in drilled or molded holes
- Fully internal through threaded

Material

Brass

Double ended
Usable both sides
Type 040

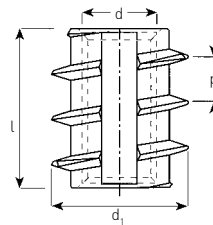

Reduced head
Type 240

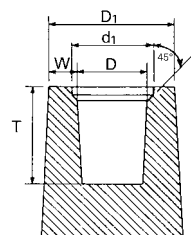
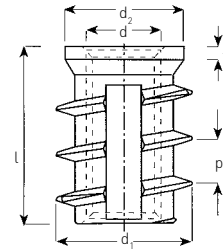

3-D Data: <http://kvt.partcommunity.com>

Order reference	Thread insert				Location hole*			
	d	l ±0.125	d ₁ nom.	p nom.	D	W min.	D ₁ min.	T min.
040M2,5	M2.5	8.00	5.50	1.81	4.25 – 5.00	3.75	12.50	8.8
040M3	M3	8.00	5.50	1.81	4.25 – 5.00	3.75	12.50	8.8
040M3,5	M3.5	8.50	6.30	2.12	5.00 – 5.75	4.33	14.40	9.4
040M4	M4	9.00	7.10	2.31	5.70 – 6.50	4.90	16.30	9.9
040M5	M5	10.00	8.70	2.54	7.20 – 8.10	6.10	20.30	11.0
040M6	M6	12.00	10.00	2.82	8.40 – 9.30	7.00	23.30	13.2
040M8	M8	16.00	12.00	3.63	10.40 – 11.30	8.50	28.30	17.6

Order reference	Thread insert						Location hole*			
	d	l ±0.125	d ₁ nom.	p nom.	d ₂ nom.	t nom.	D	W min.	D ₁ min.	T min.
240M3	M3	9.00	5.50	1.81	5.50	0.50	4.25 – 5.00	3.75	12.50	9.9
240M4	M4	11.00	7.10	2.31	7.10	0.50	5.70 – 6.50	4.90	16.30	12.1
240M5	M5	12.00	8.70	2.54	8.70	0.50	7.20 – 8.10	6.10	20.30	13.2
240M6	M6	16.00	10.00	2.82	10.00	0.60	8.40 – 9.30	7.00	23.30	17.6
240M8	M8	20.00	12.00	3.63	12.00	0.70	10.40 – 11.30	8.50	28.30	22.0

* Installation data: Please note that the dimensions quoted represent standard values and may vary depending on the material of the molded part. It is advisable to run trials prior to series production.

Installation equipment

TRISERT®, TRISERT-3® and FOAMSERT®

Production driver

(magnified picture)
For pantograph tool

Ordering example for M2:
029EM2-01, etc.



Pantograph

Pneumatic screwdriver with an automatic reverse torque-clutch control

Picture with tool stud linear quick for vertical, stationary mounting and mounting piece, not included in the delivery.



Hand installation tool

With hexagonal retainer for prototyping and small series

Ordering example for M4:
031M4, etc.



Thread inserts

MULTISERT®



- Unheaded
- Particularly suitable for thermoplastic materials
- Patented external form
- Special plain location spigot

Installation options

Press-fitting
Ultrasonic insertion
Heat insertion

Material

Brass

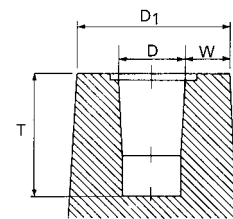
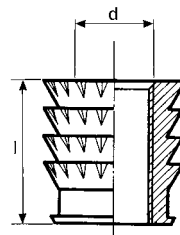

Typical application

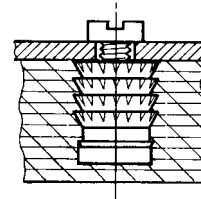

3-D Data: <http://kvt.partcommunity.com>

Order reference	Thread insert		Location hole*			
	d	l 0 -0.25	D	W min.	D ₁ min.	T min.
001M2 002M2	M2 M2	4.20 3.10	3.00 – 3.30 3.00 – 3.30	1.35 1.35	6.0 6.0	4.3 3.2
001M2,5 002M2,5	M2.5 M2.5	5.20 4.10	3.70 – 4.00 3.70 – 4.00	1.70 1.70	7.4 7.4	5.3 4.2
001M3 002M3	M3 M3	5.20 4.10	3.70 – 4.00 3.70 – 4.00	1.70 1.70	7.4 7.4	5.3 4.2
001M3,5 002M3,5	M3.5 M3.5	7.00 4.10	4.60 – 5.00 4.60 – 5.00	2.25 2.25	9.5 9.5	7.2 4.2
001M4 002M4	M4 M4	8.50 5.60	5.40 – 5.90 5.40 – 5.90	2.50 2.50	10.9 10.9	8.6 5.8
001M5 002M5	M5 M5	10.10 6.60	6.00 – 6.50 6.00 – 6.50	2.85 2.85	12.2 12.2	10.2 6.8
001M6 002M6	M6 M6	12.30 7.70	7.70 – 8.20 7.70 – 8.20	3.20 3.20	14.6 14.6	12.5 7.9
001M8 002M8	M8 M8	13.80 8.30	10.20 – 10.60 10.20 – 10.60	4.25 4.25	19.1 19.1	14.0 8.9
001M10 002M10	M10 M10	16.10 10.50	12.50 – 13.00 12.50 – 13.00	5.10 5.10	23.2 23.2	16.3 10.7
001M12	M12	16.10	15.00 – 15.40	5.20	25.8	16.3

* Installation data: Please note that the dimensions quoted represent standard values and may vary depending on the material of the molded part. It is advisable to run trials prior to series production.

Thread inserts

MULTISERT®



- Single thickness head with large head diameter
- Particularly suitable for thermoplastic materials
- Patented external form
- Special positioning shaft

Installation options

Press-fitting
Heat insertion

Material

Brass

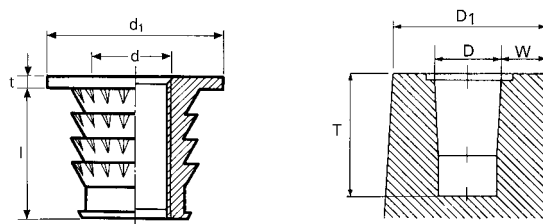

Typical applications

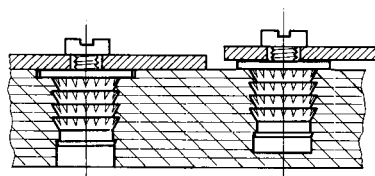

3-D Data: <http://kvt.partcommunity.com>

Order reference	Thread insert				Location hole*			
	d	l 0 -0.25	t ± 0.15	d ₁ nom.	D	W min.	D ₁ min.	T min.
003M2,5 004M2,5	M2.5 M2.5	5.20 4.10	0.75 0.75	7.1 7.1	3.70 – 4.00 3.70 – 4.00	1.70 1.70	7.4 7.4	5.3 4.2
003M3 004M3	M3 M3	5.20 4.10	0.75 0.75	7.1 7.1	3.70 – 4.00 3.70 – 4.00	1.70 1.70	7.4 7.4	5.3 4.2
003M3,5 004M3,5	M3.5 M3.5	7.00 4.10	0.75 0.75	7.9 7.9	4.60 – 5.00 4.60 – 5.00	2.25 2.25	9.5 9.5	7.2 4.2
003M4 004M4	M4 M4	8.50 5.60	0.75 0.75	8.7 8.7	5.40 – 5.90 5.40 – 5.90	2.50 2.50	10.9 10.9	8.6 5.8
003M5 004M5	M5 M5	10.10 6.60	0.90 0.90	11.1 11.1	6.00 – 6.50 6.00 – 6.50	2.85 2.85	12.2 12.2	10.2 6.8
003M6 004M6	M6 M6	12.30 7.70	1.00 1.00	12.7 12.7	7.70 – 8.20 7.70 – 8.20	3.20 3.20	14.6 14.6	12.5 7.9
003M8 004M8	M8 M8	13.80 10.10	1.25 1.25	14.3 14.3	10.20 – 10.60 10.20 – 10.60	4.25 4.25	19.1 19.1	14.0 10.3

* Installation data: Please note that the dimensions quoted represent standard values and may vary depending on the material of the molded part. It is advisable to run trials prior to series production.

Thread inserts

MULTISERT®



- Single thickness head with small head diameter
- Particularly suitable for thermoplastic materials
- Patented external form
- Special plain location spigot

Installation options

Press-in
 Ultrasonic insertion (type 073 only)
 Heat insertion

Material

Brass

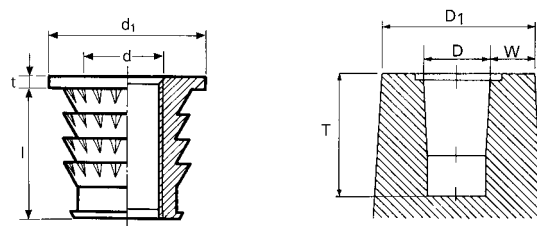

Typical applications

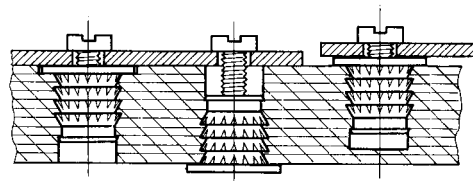

3-D Data: <http://kvt.partcommunity.com>

Order reference	Thread insert				Location hole*			
	d	l 0 - 0.25	t ± 0.15	d ₁ nom.	D	W min.	D ₁ min.	T min.
073M1,6	M1.6	2.00	0.50	3.2	2.30 - 2.50	1.00	4.5	2.1
071M2	M2	4.20	0.50	4.8	3.00 - 3.30	1.35	6.0	4.3
073M2	M2	2.00	0.50	4.8	3.00 - 3.30	1.35	6.0	2.1
071M2,5	M2.5	5.20	0.75	5.5	3.70 - 4.00	1.70	7.4	5.3
073M2,5	M2.5	4.10	0.75	5.5	3.70 - 4.00	1.70	7.4	4.2
071M3	M3	5.20	0.75	5.5	3.70 - 4.00	1.70	7.4	5.3
073M3	M3	4.10	0.75	5.5	3.70 - 4.00	1.70	7.4	4.2
071M3,5	M3.5	7.00	0.75	6.4	4.60 - 5.00	2.25	9.5	7.2
073M3,5	M3.5	4.10	1.25	6.4	4.60 - 5.00	2.25	9.5	4.2
071M4	M4	8.50	0.75	7.1	5.40 - 5.90	2.50	10.9	8.6
072M4	M4	5.60	0.75	7.1	5.40 - 5.90	2.50	10.9	5.8
073M4	M4	5.60	1.50	7.1	5.40 - 5.90	2.50	10.9	5.8
071M5	M5	10.10	1.00	7.9	6.00 - 6.50	2.85	12.2	10.2
072M5	M5	6.60	0.90	7.9	6.00 - 6.50	2.85	12.2	6.8
073M5	M5	6.60	1.75	7.9	6.00 - 6.50	2.85	12.2	6.8
071M6	M6	12.30	1.30	9.5	7.70 - 8.20	3.20	14.6	12.5
072M6	M6	7.70	1.30	9.5	7.70 - 8.20	3.20	14.6	7.9
073M6	M6	7.70	2.00	9.5	7.70 - 8.20	3.20	14.6	7.9
073M8	M8	10.10	2.50	12.7	10.20 - 10.60	4.25	19.1	10.3
073M10	M10	10.10	2.50	14.3	12.50 - 13.00	5.10	23.2	10.3

* Installation data: Please note that the dimensions quoted represent standard values and may vary depending on the material of the molded part. It is advisable to run trials prior to series production.

Thread inserts

MULTISERT®



- Double thickness head with large head diameter
- Particularly suitable for thermoplastic materials
- Patented external form
- Special plain location spigot

Installation options

Press-fitting
Ultrasonic insertion
Heat insertion

Material

Brass

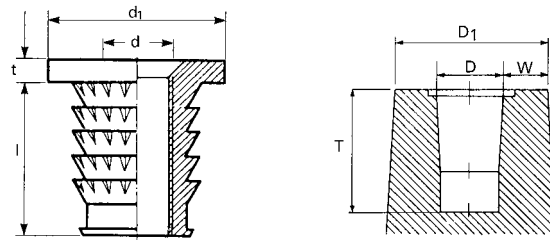

Typical applications

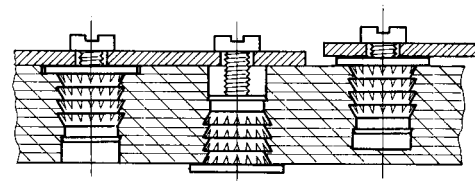

3-D Data: <http://kvt.partcommunity.com>

Order reference	Thread insert				Location hole*			
	d	l 0 - 0.25	t ± 0.15	d ₁ nom.	D	W min.	D ₁ min.	T min.
005M3 006M3	M3	5.20 4.10	1.50 1.50	7.1 7.1	3.70 - 4.00 3.70 - 4.00	1.70 1.70	7.4 7.4	5.3 4.2
005M3,5 006M3,5	M3.5 M3.5	7.00 4.10	1.25 1.25	7.9 7.9	4.60 - 5.00 4.60 - 5.00	2.25 2.25	9.5 9.5	7.2 4.2
005M4 006M4	M4 M4	8.50 5.60	1.50 1.50	8.7 8.7	5.40 - 5.90 5.40 - 5.90	2.50 2.50	10.9 10.9	8.6 5.8
005M5 006M5	M5 M5	10.10 6.60	1.75 1.75	11.1 11.1	6.00 - 6.50 6.00 - 6.50	2.85 2.85	12.2 12.2	10.2 6.8
005M6 006M6	M6 M6	12.30 7.70	2.00 2.00	12.7 12.7	7.70 - 8.20 7.70 - 8.20	3.20 3.20	14.6 14.6	12.5 7.9
005M8 006M8	M8 M8	13.80 10.10	2.50 2.50	14.3 14.3	10.20 - 10.60 10.20 - 10.60	4.25 4.25	19.1 19.1	14.0 10.3

* Installation data: Please note that the dimensions quoted represent standard values and may vary depending on the material of the molded part. It is advisable to run trials prior to series production.

Thread inserts

MICROBARB®



- With micro knurling
- Particularly suitable for thermoplastic materials
- Patented external form
- Particularly suitable for thin section materials
- Especially for applications in electronics

Installation options

Press-fitting
 Ultrasonic insertion
 Heat insertion

Material

Brass

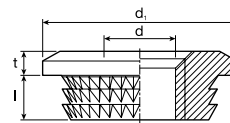

Chamfer from thread size M4

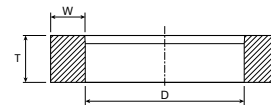

$$w = (\frac{1}{2} D \times 1.66 \dots) - (\frac{1}{2} D)$$

Typical applications

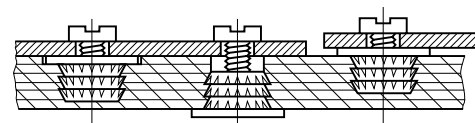

3-D Data: <http://kvt.partcommunity.com>

Order reference	Thread insert					Location hole*	
	d	l 0 -0.2	d ₁ 0 -0.2	t 0 -0.2	Barbs	D	T min.
0006M2	M2	1.35	4.90	0.55	2	3.30	1.45
0006M2,5	M2.5	1.85	5.60	0.85	2	4.15	2.00
0006M3	M3	1.85	6.10	0.85	2	4.66	2.00
0006M4	M4	3.00	7.90	1.00	3	6.13	3.20
0006M5	M5	3.00	10.00	1.40	3	7.70	3.20
0006M6	M6	3.00	12.70	1.70	3	9.55	3.20
0006M8	M8	4.55	14.30	1.70	3	11.55	4.75
0006M10	M10	4.55	16.00	3.15	3	13.05	4.75

* Installation data: Please note that the dimensions quoted represent standard values and may vary depending on the material of the molded part. It is advisable to run trials prior to series production.

Thermal pressing device

For MULTISERT® and MICROBARB® thread inserts

Heat Inserter 074/02

- Installation speed control
- Variable temperature
- 75 mm stroke
- Adjustable stop position
- Rugged construction
- CE marked
- Voltage 230 V AC 50 Hz
- Output 400w
- Heat Tip in scope of supply

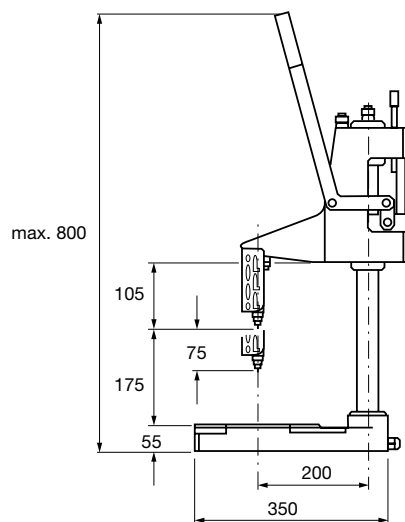

View from above

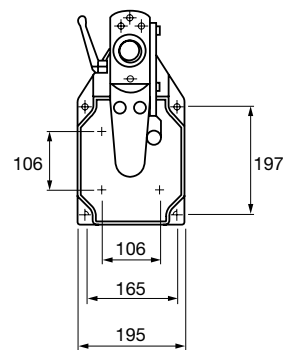

Thread inserts

HiMOULD®



- **Open ended design**
- **For moulding in** during the cycle of the moulding machine
- **For thermoplastic materials and thermoset plastics**
- Sharp increase in axial forces due to additional grooves
- Can be plugged onto smooth locating pins
- Free of swarf after molding process
- Very thin-walled, particularly suitable for applications with low wall thickness

Material

Brass

Thread insert

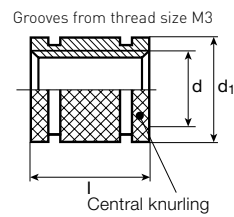

Recommended pin design

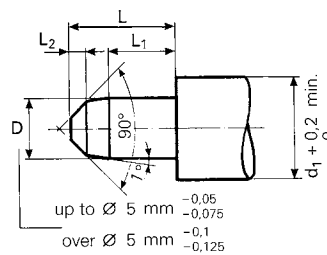

3-D Data: <http://kvt.partcommunity.com>

Order reference	d	l ± 0.10	d ₁ ± 0.25	D	L 0 - 0.25	L ₁	L ₂
017M2	M2	3.925	3.40	1.60	3.60	2.00	0.70
017M2,5	M2.5	4.725	4.15	2.05	4.40	2.56	0.70
117M3	M3	4.725	4.15	2.50	4.40	3.13	0.75
117M3,5	M3.5	5.875	5.00	2.90	5.85	3.63	0.80
117M4	M4	7.125	5.90	3.30	6.80	4.13	0.85
117M5	M5	7.825	6.60	4.20	7.50	5.25	0.90
117M6	M6	9.925	9.25	5.00	9.60	6.25	0.95
117M8	M8	12.475	11.50	6.80	12.15	8.50	1.00
117M10	M10	13.975	13.90	8.50	13.65	10.63	1.00
117M12	M12	13.975	16.30	10.25	13.65	12.81	1.00

Thread inserts

HiMOULD®



- **Blind-ended design**
- **For moulding in** during the cycle of the moulding machine
- **For thermoplastic materials and thermoset plastics**
- Sharp increase in axial forces due to additional grooves
- Can be plugged onto smooth locating pins
- Free of swarf after moulding process
- Very thin-walled, particularly suitable for applications with low wall thickness

Material

Brass

Thread insert

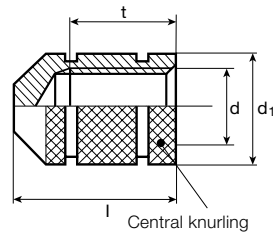

Recommended pin design

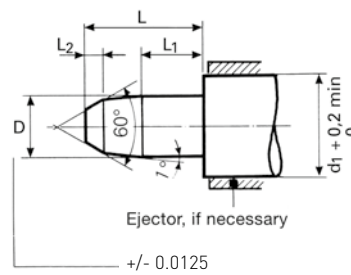

3-D Data: <http://kvt.partcommunity.com>

Order reference	d	l ± 0.25	d ₁ ± 0.25	t nom.	D	L 0 - 0.25	L ₁	L ₂
116M3	M3	6.4	4.15	3.70	2.5	4.8	3.13	0.75
116M3,5	M3.5	7.9	5.00	4.90	2.9	5.4	3.63	0.80
116M4	M4	8.7	5.90	5.45	3.3	5.8	4.13	0.85
116M5	M5	9.5	6.60	6.45	4.2	6.7	5.25	0.90
116M6	M6	12.5	10.00	8.30	5.0	7.5	6.25	0.95

Thread inserts

HiMOULD®



Blind ended design with a counter bore in open end, which press fits on to a suitable design of tapered shouldered pin in the mold tool.

- For moulding in during the cycle of the moulding machine
- For thermoplastic materials and thermoset plastics
- Sharp increase in axial forces due to additional grooves
- Can be plugged onto smooth locating pins
- Free of swarf after molding process
- Very thin-walled, particularly suitable for applications with low wall thickness

Material

Brass

Thread insert

Grooves from thread size M3

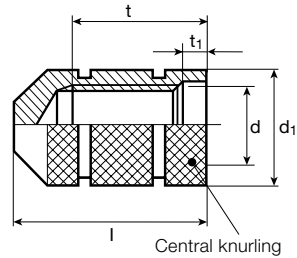

Recommended pin design

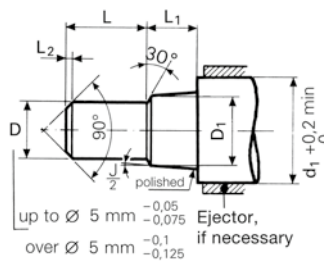

3-D Data: <http://kvt.partcommunity.com>

Order reference	d	l ± 0.25	d ₁ ± 0.25	t nom.	t ₁ nom.	D ₁ ± 0.0125	L 0 - 0.25	D	L ₁ - 0.075 - 0.125	L ₂	J
018M2	M2	5.60	3.40	3.75	0.85	2.300	2.50	1.60	0.85	0.20	6.0°
018M2,5	M2.5	6.50	4.15	4.10	0.95	2.800	3.00	2.05	0.95	0.20	5.0°
118M3	M3	7.45	4.60	4.75	1.10	3.125	3.50	2.50	1.10	0.25	4.5°
118M3,5	M3.5	9.30	5.00	6.25	1.35	3.750	4.50	2.90	1.35	0.30	4.5°
118M4	M4	10.30	5.90	7.05	1.60	4.425	5.00	3.30	1.60	0.35	4.5°
118M5	M5	11.30	6.60	8.35	1.75	5.125	5.75	4.20	1.75	0.40	5.0°
118M6	M6	14.50	10.00	10.35	1.85	6.600	6.75	5.00	1.85	0.45	4.5°
118M8	M8	16.60	11.50	12.00	2.05	8.500	9.00	6.80	2.05	0.50	4.5°
118M10	M10	18.00	13.90	13.00	2.15	10.500	10.00	8.50	2.15	0.55	4.5°

Technical data

We inform you that the values presented here are **benchmark values** and can differ depending on the application. Tests are highly recommended before beginning serial production!

TRISERT® series 145

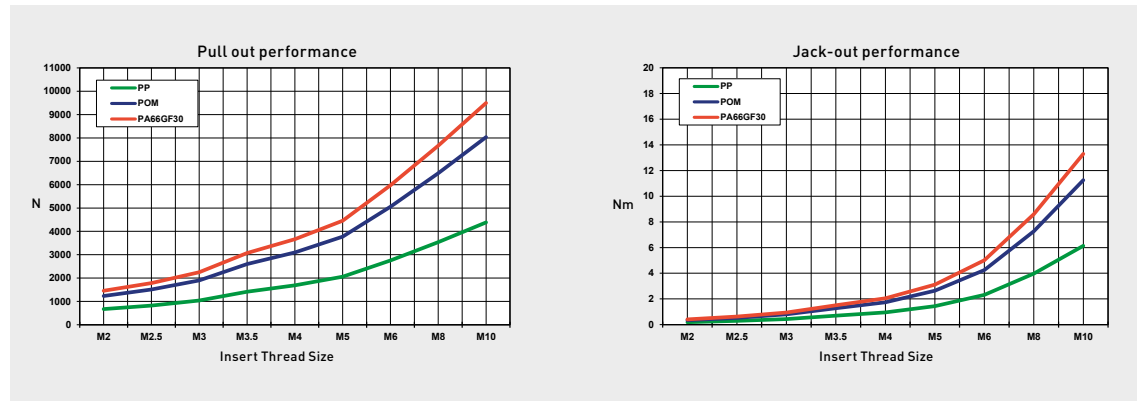

TRISERT® series 136

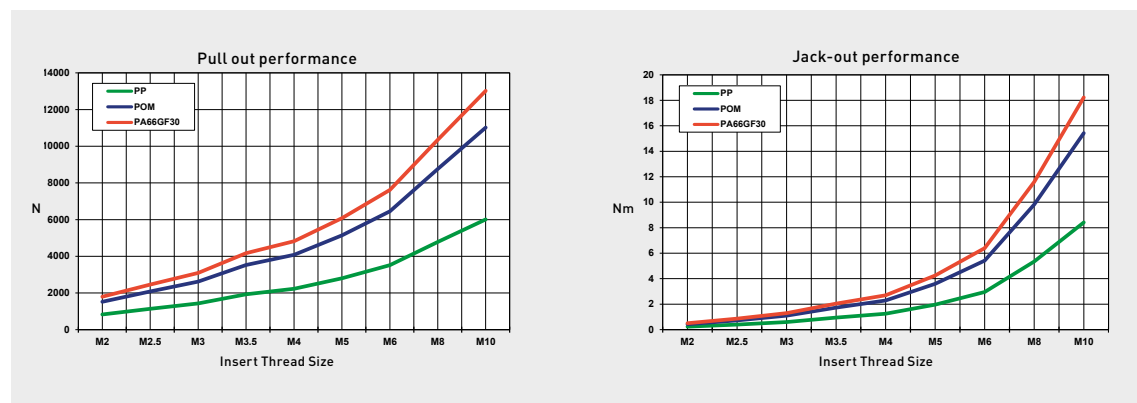

TRISERT® series 137

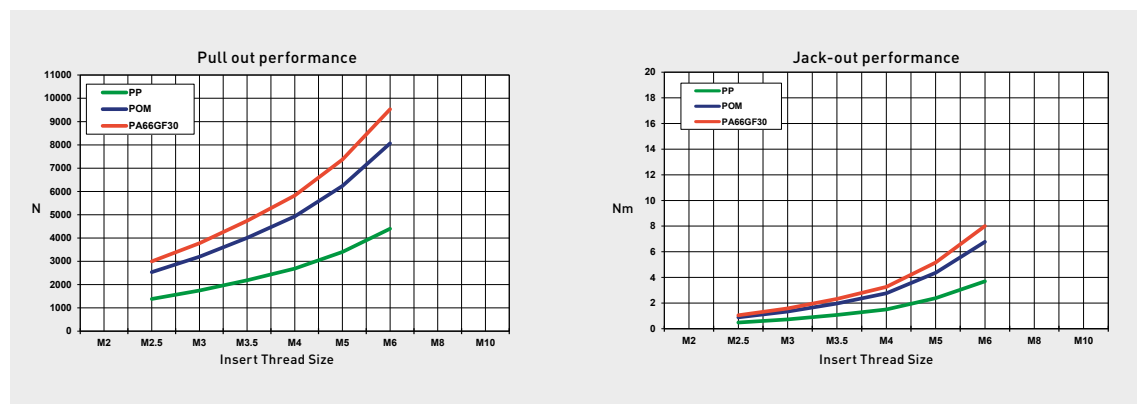

Technical data

We inform you that the values presented here are **benchmark values** and can differ depending on the application. Tests are highly recommended before beginning serial production!

MULTISERT® series 001

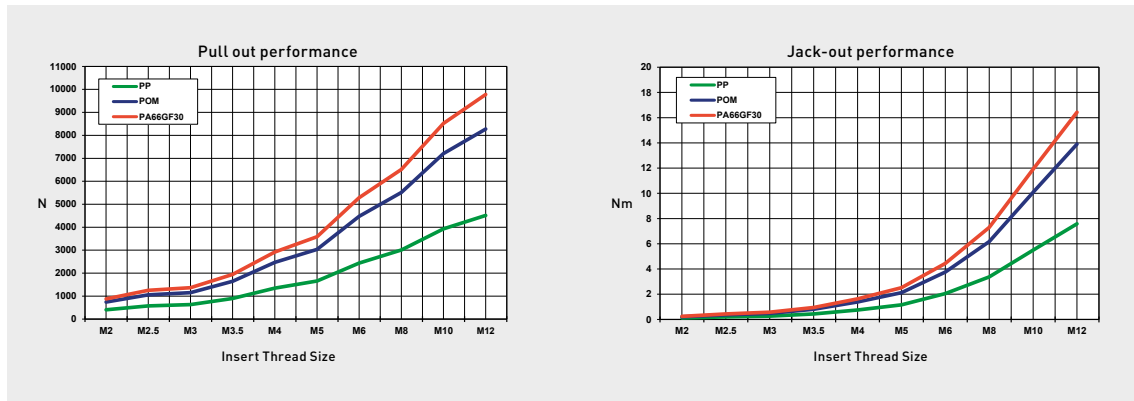

MULTISERT® series 002

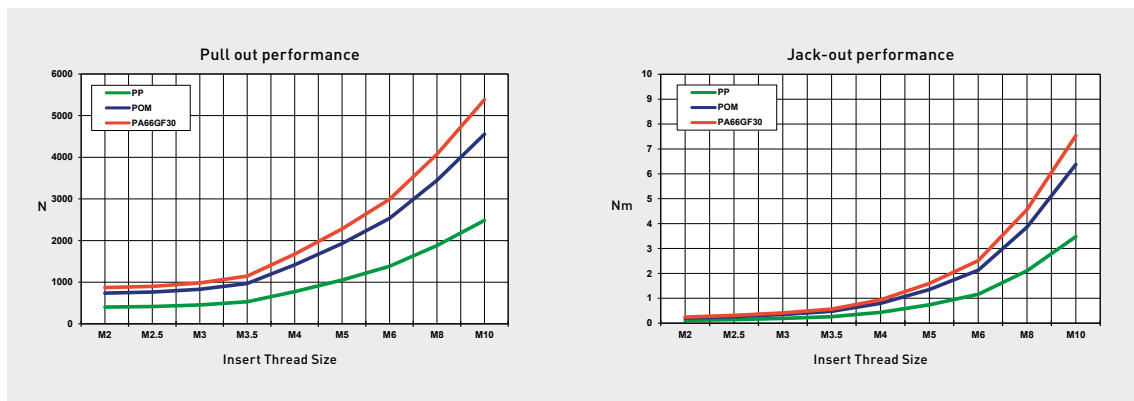

Performance data for heat installed thread inserts MULTISERT® series 001 and 002.

Technical data

We inform you that the values presented here are **benchmark values** and can differ depending on the application. Tests are highly recommended before beginning serial production!

HiMOULD® series 117

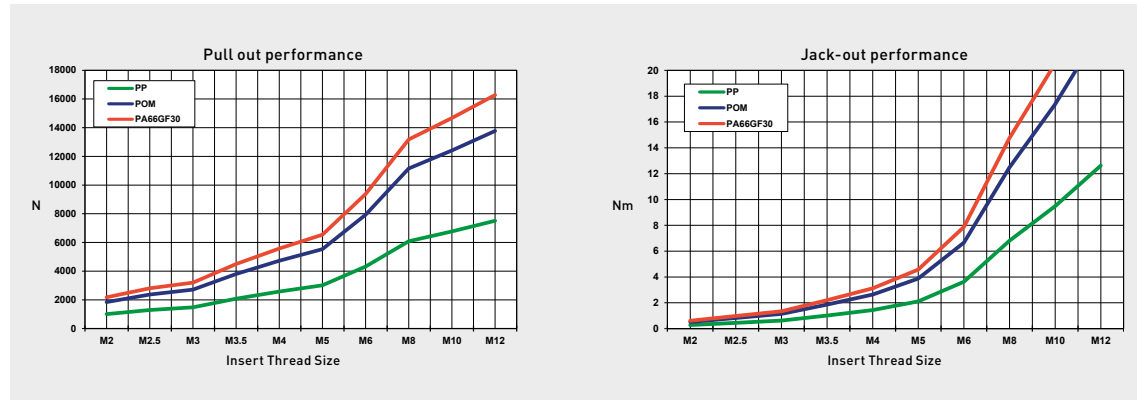

HiMOULD® series 116

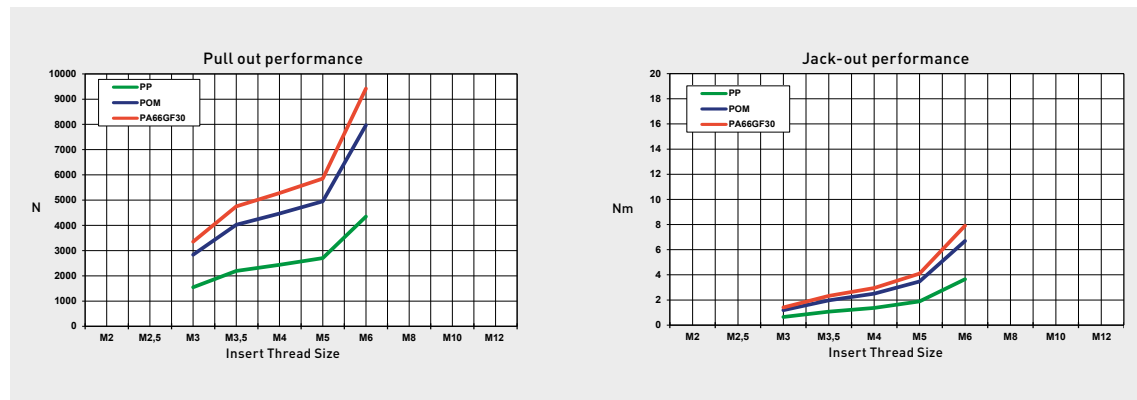

HiMOULD® series 118

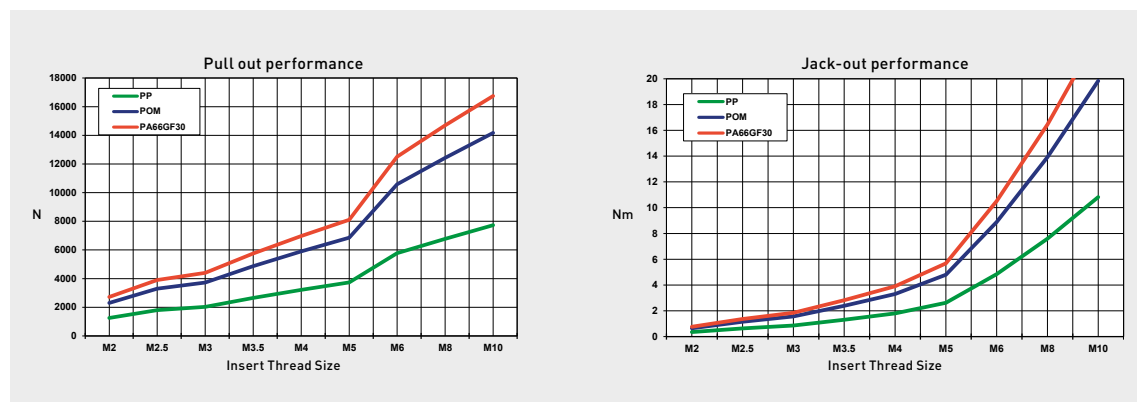

Test procedures

Based on practical tests, we offer test values to constructors to enable them to realize even special applications, normally with standard parts.

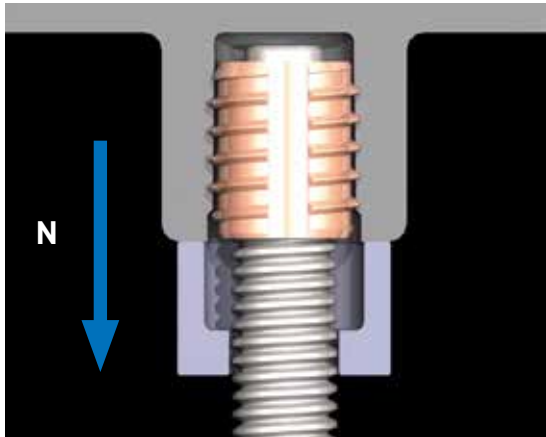

Pull-out Force

The pull-out force is defined as the maximum axial load on the insert until the insert is removed from the parent material.

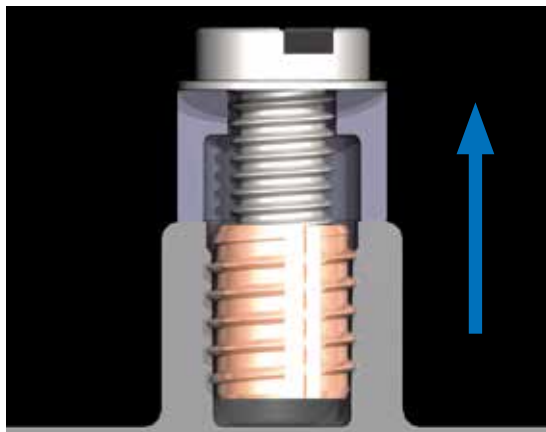
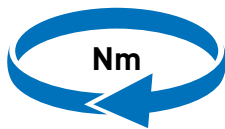

Jack-out Torque

The pull-out force is defined as the maximum axial-torque on the insert by tightening the fastener until the insert is moved in an axial way.

KVT-Fastening – Fastening technology



Blind rivet nuts



Blind rivet technology



Thread inserts



Self-clinching fasteners



Stud welding systems¹⁾



Lock nuts



Bonding fasteners



Access solutions

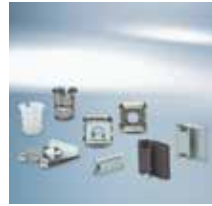

Quick fastening elements and clips



Quick release pins and spring plungers



Adhesives and sealants¹⁾



Construction fasteners²⁾



Special processes²⁾



Plugs



Pressure intensifiers³⁾



Installation technology



Quick connectors⁴⁾

Fastening, sealing and flow control solutions for complex applications

The extensive KVT-Fastening portfolio offers optimal solutions for your most challenging applications. The products included in this catalog represent only a selection from our entire product portfolio. Upon request, we will be pleased to provide additional information or an individual consultation to you.

Intelligent logistic systems

Bossard SmartBin and SmartLabel are intelligent logistics systems which monitor stock with total reliability and ensure stock replenishment automatically. An online system transmits the data to our server, and this – if necessary – triggers an order. These systems ensure quick and easy availability of C-parts while production is running.



Logistic systems

Competent analysis for efficient solutions

KVT-Fastening's highly qualified experts analyze the given task at hand. Based on this sound understanding of the project, they then develop ideal solutions that are economical, efficient, and safe.



Solutioneering

For more information about our range of products and order at our E-shop, please visit www.kvt-fastening.com

¹⁾ Not available in Germany. ²⁾ Only available in Switzerland. ³⁾ Not available in Switzerland. ⁴⁾ Not available in Austria.

KVT-Fastening
Branch of Bossard Ltd
Dietikon/Zürich | Switzerland
Tel: +41 44 743 33 33
info-CH@kvt-fastening.com
www.kvt-fastening.ch

KVT-Fastening GmbH
Illerrieden | Germany
Tel: +49 7306 782-0
info-DE@kvt-fastening.com
www.kvt-fastening.de

KVT-Fastening GmbH
Linz/Pichling | Austria
Tel: +43 732 25 77 00
info-AT@kvt-fastening.com
www.kvt-fastening.at

KVT-Fastening Sp. z o.o.
Radom | Poland
Tel: +48 58 762 17 80
info-PL@kvt-fastening.com
www.kvt-fastening.pl

KVT-Fastening S.R.L.
București | Romania
Tel: +40 37 1381155
info-RO@kvt-fastening.com
www.kvt-fastening.ro

KVT-Fastening spol. s.r.o.
Bratislava | Slovakia
Tel: +421 9 11102510
info-SK@kvt-fastening.com
www.kvt-fastening.sk

KVT-Tehnika pritrjevanja d.o.o.
Ljubljana | Slovenia
Tel: +386 1 2808019
info-SI@kvt-fastening.com
www.kvt-fastening.si

KVT-Fastening s.r.o.
Brno | Czech Republic
Tel: +420 547 125200201
info-CZ@kvt-fastening.com
www.kvt-fastening.cz

KVT-Fastening Kft.
Budapest | Hungary
Tel: +36 1 769 0925
info-HU@kvt-fastening.com
www.kvt-fastening.hu



www.kvt-fastening.com



X-ON Electronics

Largest Supplier of Electrical and Electronic Components

Click to view similar products for [Tappex](#) manufacturer:

Other Similar products are found below :

[003M4](#) [004M3](#) [002M2](#) [002M4](#) [002M6](#) [002M8](#)