

(2.00 mm) .0787"

TCMD SERIES

# HIGH-RELIABILITY IDC HEADER CABLE

Mates with:  
SMM\*, MMS\*, ESQT,  
PTF, SQT, SQW, TLE

## SPECIFICATIONS

For complete specifications see [www.samtec.com?TCMD](http://www.samtec.com?TCMD)

**Insulator Material:**  
Black Glass Filled Polyester  
**Terminal:**  
Phosphor Bronze  
**Plating:**  
Au or Sn over  
50 μm (1.27 μm) Ni  
**Wire:**  
28 AWG 7/36 Stranded,  
Tinned, Copper with  
Gray PVC Insulator  
**Current Rating:**  
2.6 A per pin  
(2 pins powered)  
**Operating Temp Range:**  
-40 °C to +105 °C  
**RoHS Compliant:**  
Yes

## RECOGNITIONS

For complete scope of recognitions see [www.samtec.com/quality](http://www.samtec.com/quality)



FILE NO. E111594

## ALSO AVAILABLE (MOQ Required)

- Other sizes

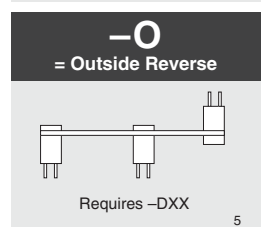
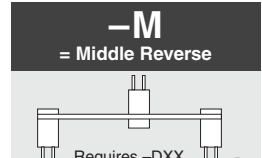
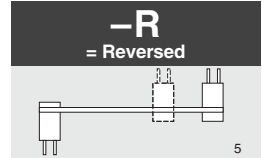
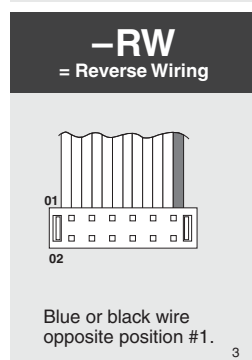
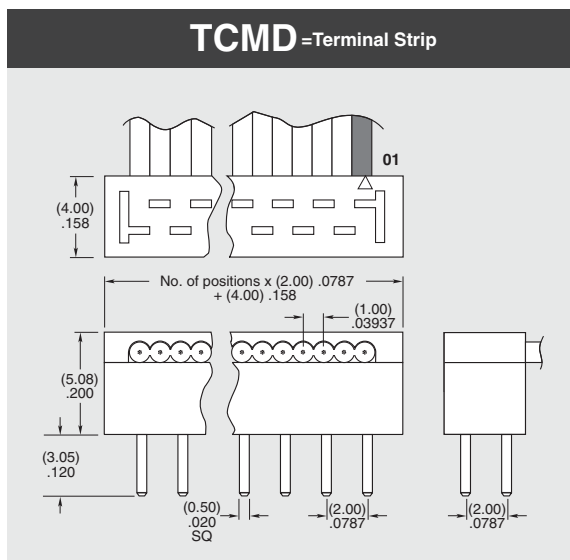
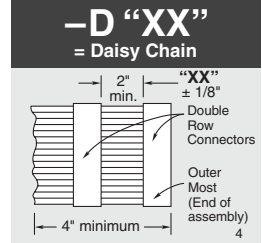
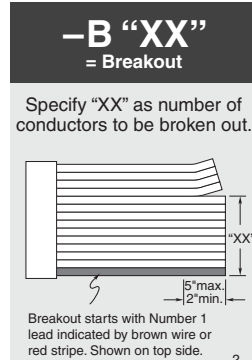
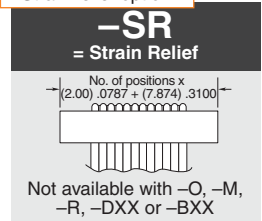
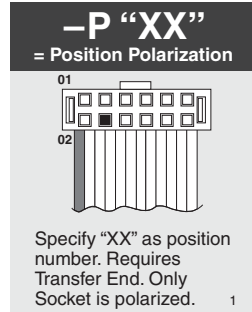
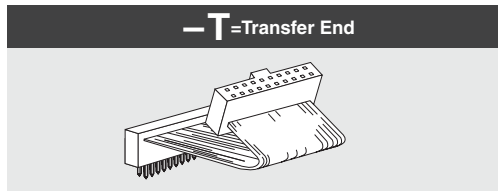
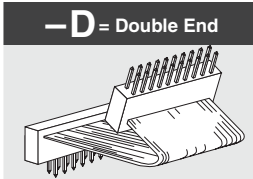
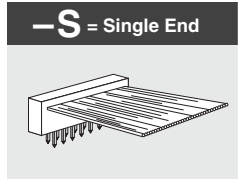
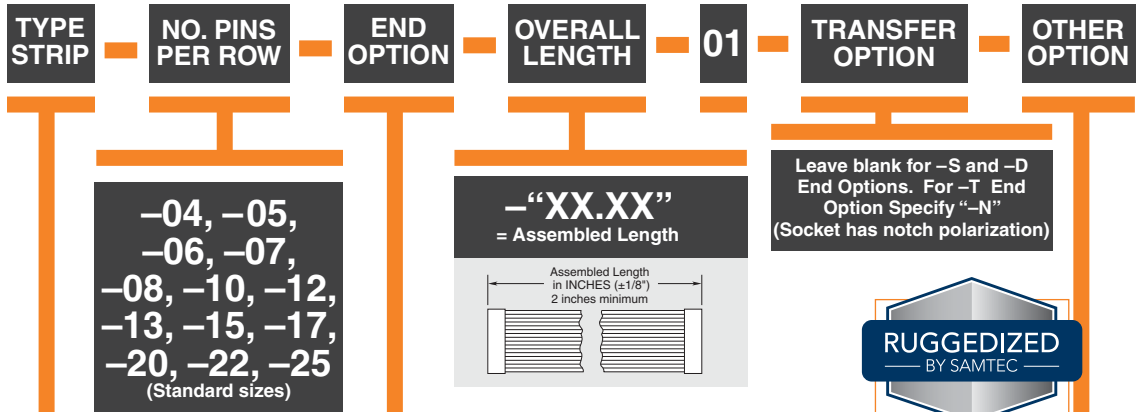

**\*Note:**  
Standard TCMD callout will not mate with SMM, MMS. Must use gold plated callouts. (See drawing on web.)  
When mated with a socket, Wire 1 mates with Pin 2; Wire 2 mates with Pin 1, etc.

**Note:**  
TCMD Series assemblies are non-standard, non-returnable.

Due to technical progress, all designs, specifications and components are subject to change without notice.

[WWW.SAMTEC.COM](http://WWW.SAMTEC.COM)

All parts within this catalog are built to Samtec's specifications. Customer specific requirements must be approved by Samtec and identified in a Samtec customer-specific drawing to apply.

## X-ON Electronics

Largest Supplier of Electrical and Electronic Components

*Click to view similar products for [Ribbon Cables / IDC Cables](#) category:*

*Click to view products by [Samtec](#) manufacturer:*

Other Similar products are found below :

[FSK-12A Ribbon Cable, 6 Pin, 500mm](#) [AWG28-10G EHV3C EHV4C EHV5C](#) [cab-LVDV-PWR-10-15 FSP-25A Ribbon Cable, 4 Pin, 350mm](#)  
[Ribbon Cable, 6 Pin, 300mm](#) [cab-LVDV-DAT-34-15](#) [49635-C62-S2](#) [1-3636-600-5204](#) [92315-1408](#) [100063-0094](#) [100063-0106](#) [100063-0102](#)  
[100063-0104](#) [MMSD-02-20C-F-15.00-S-K](#) [100063-0099](#) [100063-0105](#) [100063-0095](#) [100063-0103](#) [100063-0093](#) [100063-0091](#) [2200000068](#)  
[100063-0092](#) [100063-0101](#) [100063-0100](#) [100063-0097](#) [TFSDT-08-28-H-15.00-S](#) [S1SD-02-30-GF-09.00-L](#) [MMSD-02-22C-F-15.00-S-K](#)  
[S1SS-02-28C-GF-02.00-L](#) [S1SDT-02-28-GF-03.00-L](#) [2-1589735-3](#) [JSM015PP2DCC23N](#) [92301-0283](#) [TCSD-22-D-26.00-01](#) [S1SST-07-30-](#)  
[GF-06.00-L](#) [T2SD-20-24-L-07.87-TR-NUS](#) [DS1057-01-44A282R-30.5](#) [FFSD-06-S-17.00-01-N](#) [IDSS-03-D-20.00-T](#) [TCMD-17-S-36.00-01-](#)  
[SR](#) [92301-0718](#) [839023](#) [490107670612S](#) [MMSDT-06-20-S-05.5-D-K-LDX](#) [IDD-04-G](#)