



Ni-Zn

Mn-Zn

## Ferrites for EMI suppression

# T series (Ring-shape)

---

 **REMINDERS FOR USING THESE PRODUCTS**

Please be sure to read this manual thoroughly before using the products.

The products listed on this catalog are intended for use in general electronic equipment (AV equipment, telecommunications equipment, home appliances, amusement equipment, computer equipment, personal equipment, office equipment, measurement equipment, industrial robots) under a normal operation and use condition.

The products are not designed or warranted to meet the requirements of the applications listed below, whose performance and/or quality require a more stringent level of safety or reliability, or whose failure, malfunction or trouble could cause serious damage to society, person or property.

When using the products for specific purposes, please first make confirmations in areas such as safety, reliability, and quality.

Please note that we shall not be held responsible in any way if any damages should occur due to exceeding the scope or conditions of this manual, or through specific use these products.

- |   |  |
|---|--|
| (1) Aerospace/aviation equipment                                  | (9) Military equipment   |
| (2) Transportation equipment (cars, electric trains, ships, etc.) | (10) Electric heating apparatus, burning equipment                           |
| (3) Medical equipment   | (11) Disaster prevention/crime prevention equipment                          |
| (4) Power-generation control equipment                            | (12) Safety equipment  |
| (5) Atomic energy-related equipment                               | (13) Other applications that are not considered general-purpose applications |
| (6) Seabed equipment  |  |
| (7) Transportation control equipment                              |  |
| (8) Public information-processing equipment                       |  |

When using these products in general purposes and standard use, it is recommended that protection circuits are used, devices are secured, and backup circuits are kept for increased safety.

# Ferrites for EMI suppression

Product compatible with RoHS directive  
Halogen-free

## Overview of the T series

### FEATURES

- Select various materials according to the noise frequency.
- The product has a wide range of sizes ranging from  $\varnothing 14$  to  $\varnothing 104$  outer diameters.
- Epoxy coating is also available. (HF60 and HF90 only)

### APPLICATION

Imaging devices, audio equipment, automotive electronics, communication devices, office electronics, industrial equipment, other

- Absorption EMI and penetrating noise
- Prevent parasitic oscillation

### PART NUMBER CONSTRUCTION

For general use

HF90	T	14	×	7	×	8
Material	Core shape	Outside diameter		Height		Inside diameter

### RANGE OF USE AND STORAGE TEMPERATURE

Temperature range*	
Operating temperature (°C)	Storage temperature** (°C)
-40 to +85	-40 to +85

- RoHS Directive Compliant Product: See the following for more details. <https://product.tdk.com/info/en/environment/rohs/index.html>
- Halogen-free: indicates that Cl content is less than 900ppm, Br content is less than 900ppm, and that the total Cl and Br content is less than 1500ppm.

 Please be sure to request delivery specifications that provide further details on the features and specifications of the products for proper and safe use.  
Please note that the contents may change without any prior notice due to reasons such as upgrading.

## Ni-Zn T series (HF70)



## ■ SHAPE &amp; DIMENSIONS

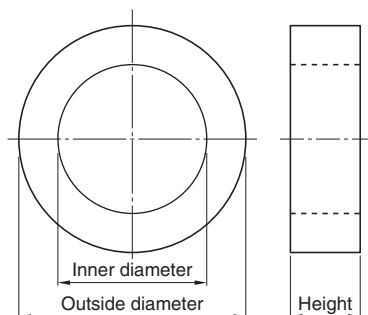

HF70	T	14	×	7	×	8
Material	Core shape	Outside diameter		Height		Inside diameter

Size	Outside diameter (mm)	Height (mm)	Inner diameter (mm)
HF70T14X7X8	14.0±0.3	7.0±0.2	8.0±0.3
HF70T18X10X10	18.0±0.3	10.0±0.3	10.0±0.3
HF70T22X10X14	22.0±0.4	10.0±0.3	14.0±0.3
HF70T25X13X15	25.0±0.3	13.0±0.25	15.0±0.3
HF70T28X13X16	28.0±0.4	13.0±0.3	16.0±0.4
HF70T31X13X19	31.0±0.5	13.0±0.25	19.0±0.5

\* HF30, HF40, HF56, and HF57 can also be used.

# Ni-Zn T series (HF70)

## ELECTRICAL CHARACTERISTICS

### IMPEDANCE VS. FREQUENCY CHARACTERISTICS

HF70T14X7X8

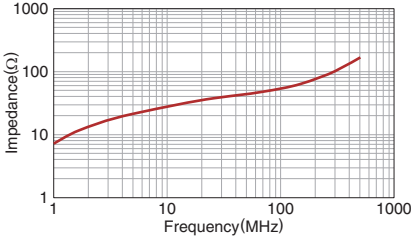

HF70T18X10X10

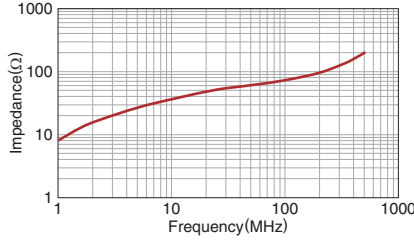

HF70T22X10X14

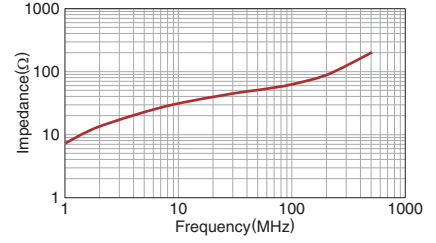

HF70T25X13X15

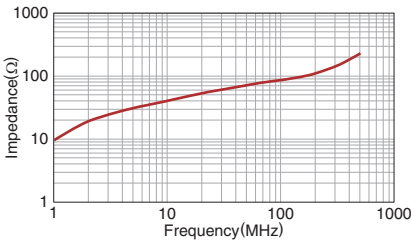

HF70T28X13X16

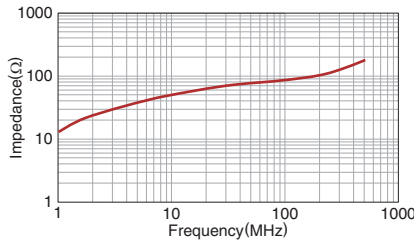

HF70T31X13X19

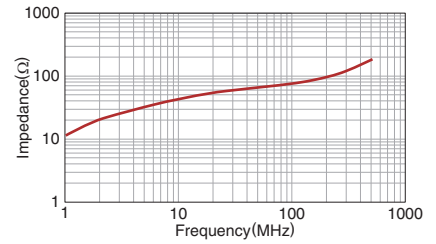

 Please be sure to request delivery specifications that provide further details on the features and specifications of the products for proper and safe use. Please note that the contents may change without any prior notice due to reasons such as upgrading.

## Mn-Zn T series (HF60)



## SHAPE &amp; DIMENSIONS

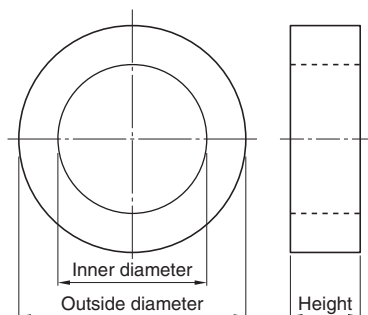

HF60	T	14	×	7	×	8
Material	Core shape	Outside diameter		Height		Inside diameter

Part No.	Outside diameter (mm)	Height (mm)	Inner diameter (mm)
HF60T14X7X8	14.0±0.5	7.0±0.5	8.0±0.5
HF60T18X10X10	18.0±0.7	10.0±0.5	10.0±0.7
HF60T22X10X14	22.0±0.7	10.0±0.5	14.0±0.7
HF60T25X13X15	25.0±1.0	13.0±1.0	15.0±1.0
HF60T28X13X16	28.0±1.0	13.0±1.0	16.0±1.0
HF60T31X13X19	31.0±1.0	13.0±1.0	19.0±1.0
HF60T38X14X22	38.0±1.0	14.0±1.0	22.0±1.0
HF60T44.5X13X30	44.5±1.0	13.0±1.0	30.0±1.0
HF60T62X13X39	62.5±1.3	13.5±1.0	39.0±1.3
HF60T80X20X50	80.0±1.6	20.0±1.0	50.0±1.6
HF60T104X20X80	104.0±2.0	20.0±1.0	80.0±2.0

# Mn-Zn T series (HF60)

## ELECTRICAL CHARACTERISTICS

### IMPEDANCE VS. FREQUENCY CHARACTERISTICS

**HF60T14X7X8**

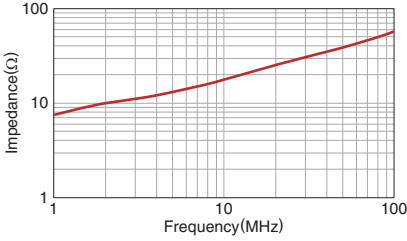

**HF60T18X10X10**

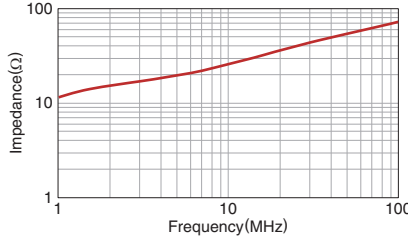

**HF60T22X10X14**

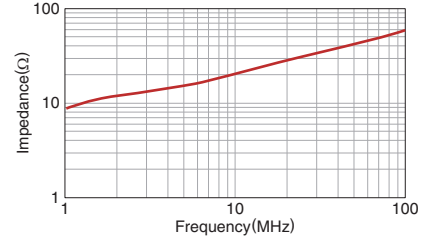

**HF60T25X13X15**

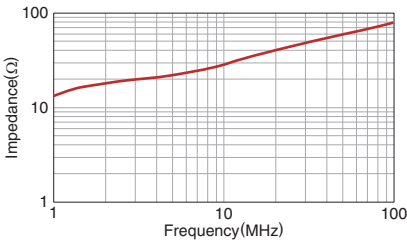

**HF60T28X13X16**

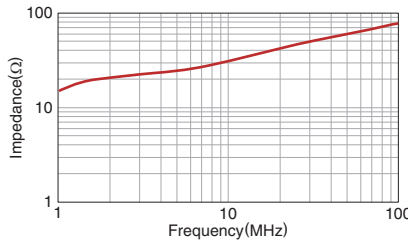

**HF60T31X13X19**

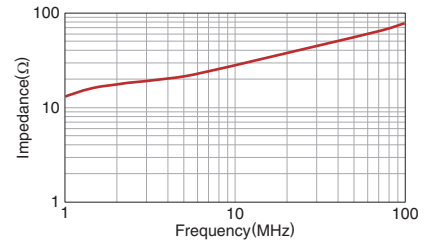

**HF60T38X14X22**

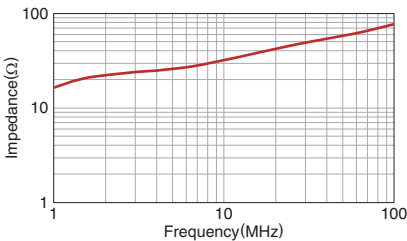

**HF60T44.5X13X30**

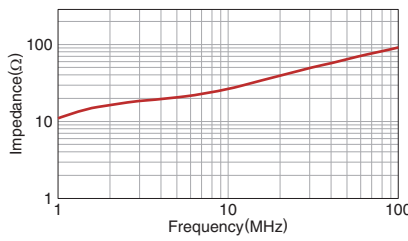

**HF60T62X13X39**

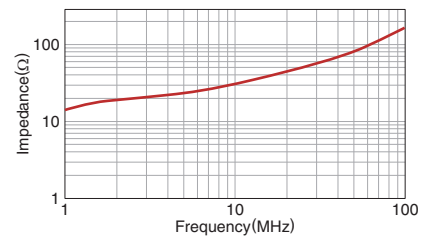

**HF60T80X20X50**

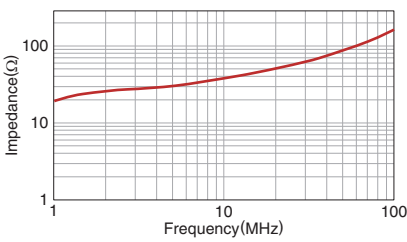

**HF60T104X20X80**

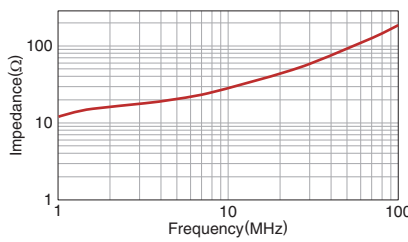

 Please be sure to request delivery specifications that provide further details on the features and specifications of the products for proper and safe use. Please note that the contents may change without any prior notice due to reasons such as upgrading.

## Mn-Zn T series (HF90)



## SHAPE &amp; DIMENSIONS

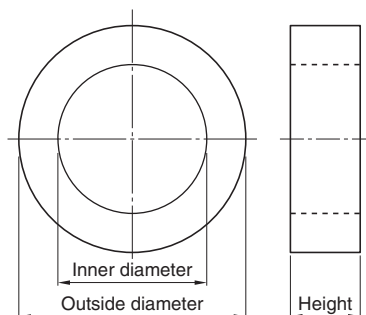

HF90	T	14	×	7	×	8
Material	Core shape	Outside diameter		Height		Inside diameter

Part No.	Outside diameter (mm)	Height (mm)	Inner diameter (mm)
HF90T14X7X8	14.0±0.3	7.0±0.2	8.0±0.3
HF90T18X10X10	18.0±0.4	10.0±0.3	10.0±0.3
HF90T22X10X14	22.0±0.4	10.0±0.3	14.0±0.3
HF90T25X13X15	25.0±0.4	13.0±0.3	15.0±0.3
HF90T28X13X16	28.0±0.4	13.0±0.3	16.0±0.4
HF90T31X13X19	31.0±0.5	13.0±0.3	19.0±0.4
HF90T38X14X22	38.0±0.8	14.0±0.3	22.0±0.5
HF90T44.5X13X30	44.5±1.1	13.0±0.5	30.0±0.8
HF90T62X13X39	62.5±1.3	13.5±0.5	39.0±0.8
HF90T80X20X50	80.0±1.6	20.0±0.5	50.0±1.0
HF90T104X20X80	104.0±2.0	20.0±0.5	80.0±1.6



# Mn-Zn T series (HF90)

## ELECTRICAL CHARACTERISTICS

### IMPEDANCE VS. FREQUENCY CHARACTERISTICS

**HF90T14X7X8**

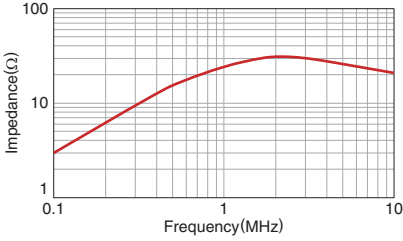

**HF90T18X10X10**

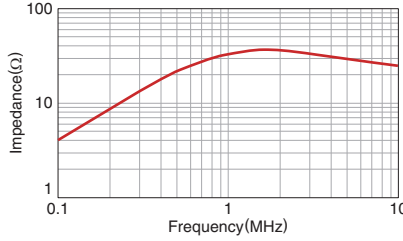

**HF90T22X10X14**

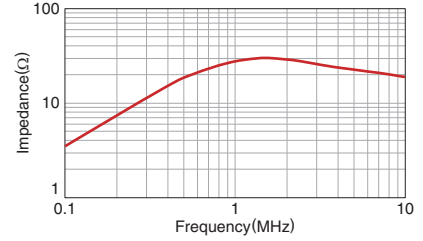

**HF90T25X13X15**

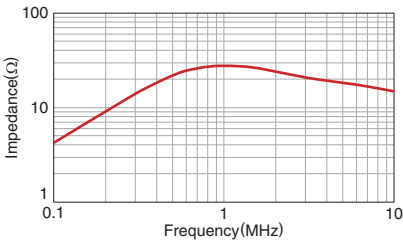

**HF90T28X13X16**

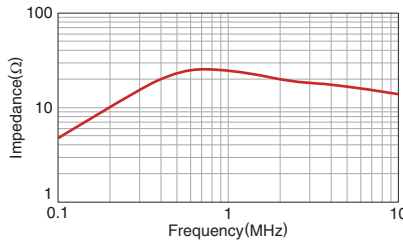

**HF90T31X13X19**

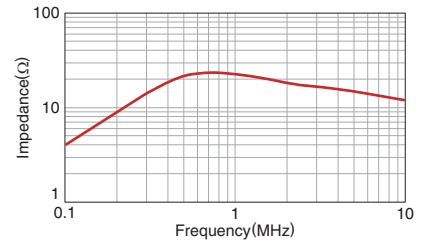

**HF90T38X14X22**

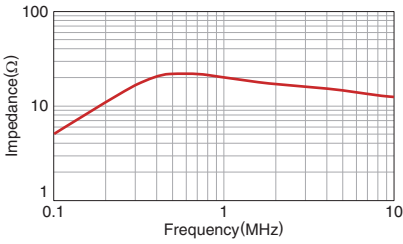

**HF90T44.5X13X30**

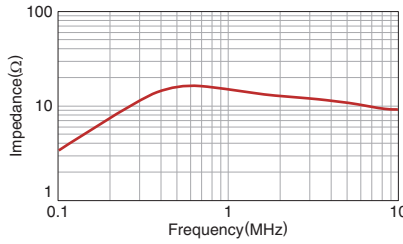

**HF90T62X13X39**

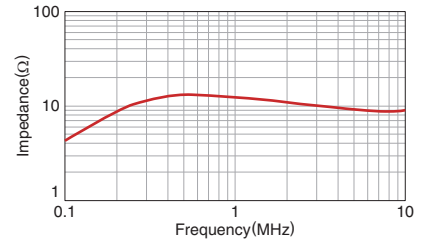

**HF90T80X20X50**

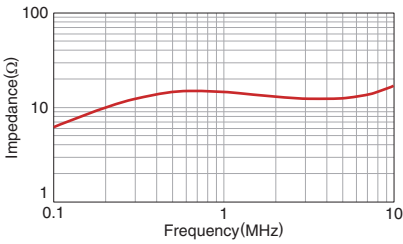

**HF90T104X20X80**

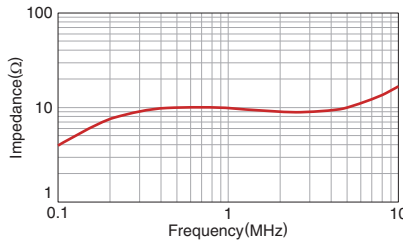

 Please be sure to request delivery specifications that provide further details on the features and specifications of the products for proper and safe use. Please note that the contents may change without any prior notice due to reasons such as upgrading.

## X-ON Electronics

Largest Supplier of Electrical and Electronic Components

*Click to view similar products for [Ferrite Toroids / Ferrite Rings](#) category:*

*Click to view products by [TDK](#) manufacturer:*

Other Similar products are found below :

[5943001601](#) [28B0200-4](#) [28B0250-1](#) [29D3800-000](#) [28B0137-3](#) [4327 018 35221](#) [432703013571](#) [432703033201](#) [4327 030 37511](#) [4327 030 37911](#) [4327 030 57161](#) [432703057191](#) [B62152P0007X030](#) [432202090241](#) [432202101631](#) [432202133882](#) [432703012441](#) [4327 030 12521](#) [4327 030 57111](#) [5343232001](#) [5943000901](#) [432703034521](#) [5961004101](#) [5961000621](#) [4078034621](#) [4077378111](#) [28B1250-2](#) [28B2000-3](#) [28B1387-1](#) [B64291A1304X000](#) [28B2400-0](#) [B64290A0699X010](#) [5510-017](#) [5961000811](#) [CBCT-35-1](#) [CBCT-120-1](#) [CBCT-70-1](#) [5977004801](#) [5976000201](#) [5968003801](#) [5975011101](#) [5977000501](#) [5978008001](#) [28B0355-0](#) [7427018](#) [M-060](#) [CST29/19/7.5-4S2](#) [T9X8X5](#) [4077485111](#)  
[TN10/6/4-3F3](#)