

Inductors for power circuits

Wound ferrite

VLS-EX-H series (for automotive)



AEC-Q200

VLS5045EX-H type



FEATURES

- Magnetic shield type wound inductor for power circuits.
- High magnetic shield construction achieved by a ferrite magnetic material and compatible with high-density mounting.
- Larger current and lower R_{dc} were achieved by optimizing the ferrite core figure.
- Operating temperature range: -40 to +125 °C (including self-temperature rise)
- Compliant with AEC-Q200

APPLICATION

- Automotive-related equipment (ECM, airbags, headlights, electronic power steering, meters, ABS, other)

PART NUMBER CONSTRUCTION

VLS	5045	EX	-	1R0	H
Series name	L×W×H dimensions 5.0×5.3×4.5 mm	Internal code		Inductance (μH)	Internal code

CHARACTERISTICS SPECIFICATION TABLE

L (μH)	Measuring frequency		DC resistance (Ω)±30%	Rated current*		Part No.
	Tolerance	(kHz)		Idc1 (A)max.	Idc2 (A)typ.	
1.0	±30%	100	0.015	8.9	5.1	VLS5045EX-1R0N-H
2.2	±30%	100	0.022	6.4	4.7	VLS5045EX-2R2N-H
4.7	±20%	100	0.036	4.4	3.2	VLS5045EX-4R7M-H
10	±20%	100	0.061	3.1	2.5	VLS5045EX-100M-H
22	±20%	100	0.125	2.0	1.8	VLS5045EX-220M-H
47	±20%	100	0.30	1.3	1.0	VLS5045EX-470M-H
100	±20%	100	0.58	0.8	0.7	VLS5045EX-101M-H
220	±20%	100	1.05	0.45	0.45	VLS5045EX-221M-H

* Rated current: smaller value of either Isat or Itemp.

Isat: When based on the inductance change rate (30% below the initial L value)

Itemp: When based on the temperature increase (temperature increase of 40°C by self heating)

Measurement equipment

Measurement item	Product No.	Manufacturer
L	4294A	Keysight Technologies, Inc. (formerly Hewlett-Packard)
DC resistance	34420A	Keysight Technologies, Inc. (formerly Hewlett-Packard)
Rated current Isat	4284A+42841A+42842A	Keysight Technologies, Inc. (formerly Hewlett-Packard)

* Equivalent measurement equipment may be used.

TEMPERATURE RANGE, INDIVIDUAL WEIGHT

Operating temperature range*	Storage temperature range**	Individual weight
-40 to 125 °C	-40 to 125 °C	0.4 g

* Operating temperature range includes self-temperature rise.

** The storage temperature range is for after the assembly.



VLS5045EX-H type

L FREQUENCY CHARACTERISTICS

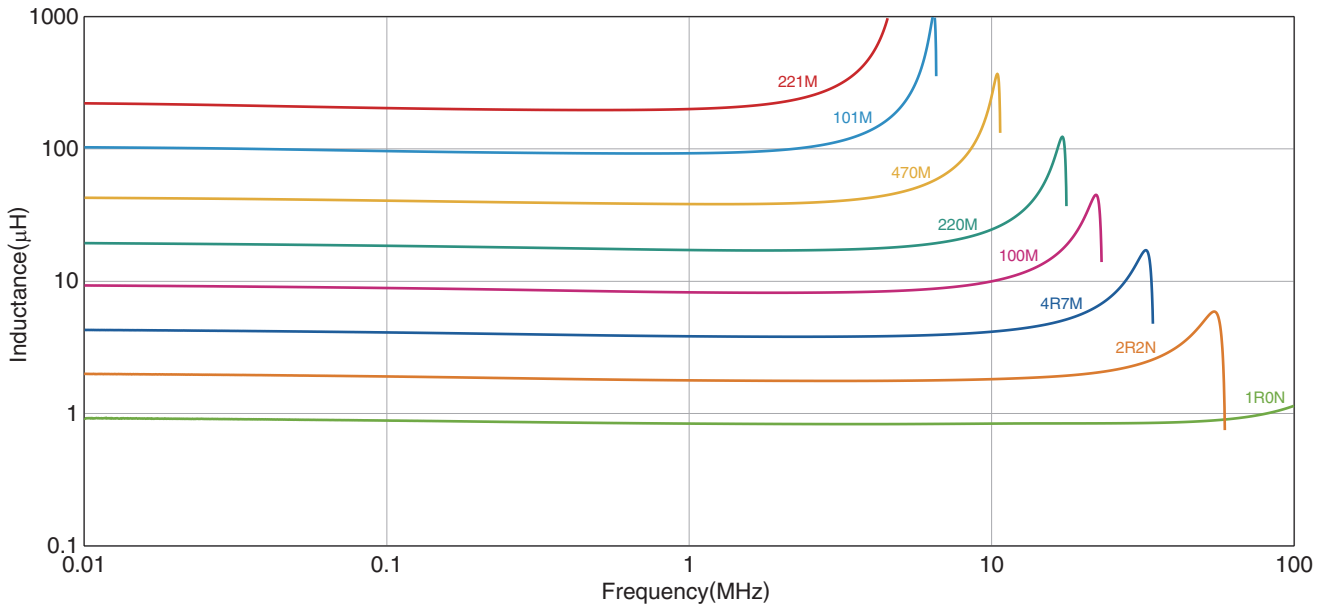

Measurement equipment

Product No.	Manufacturer
4294A	Keysight Technologies, Inc. (formerly Hewlett-Packard)

* Equivalent measurement equipment may be used.

INDUCTANCE VS. DC BIAS CHARACTERISTICS

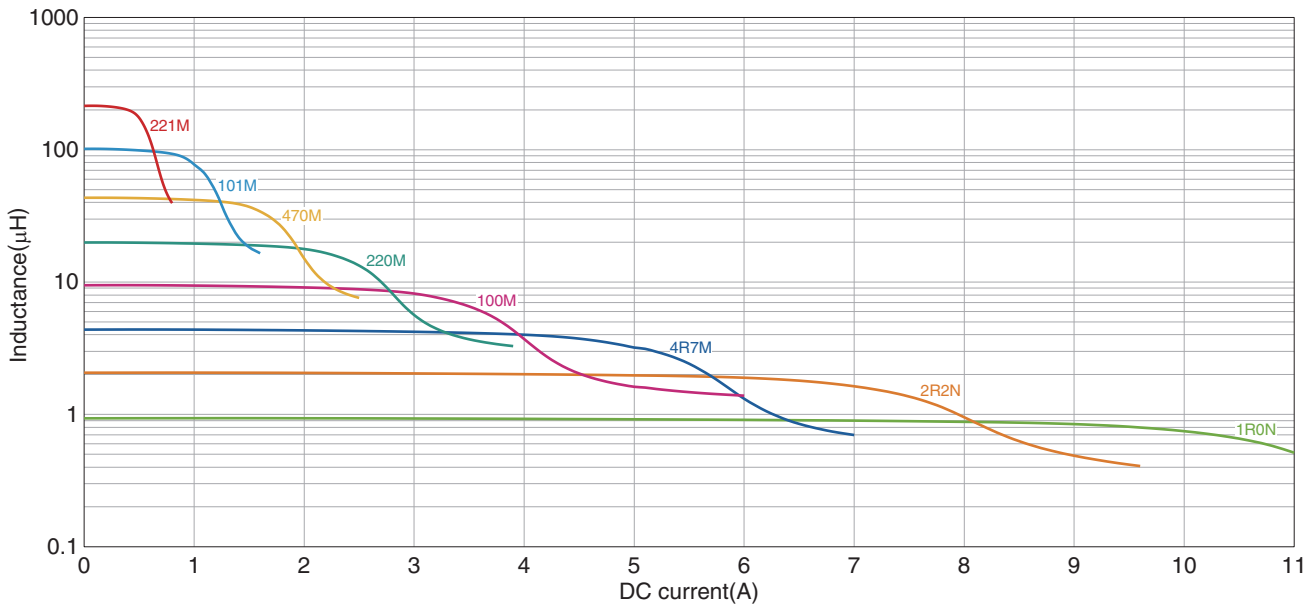

Measurement equipment

Product No.	Manufacturer
4284A+42841A+42842A	Keysight Technologies, Inc. (formerly Hewlett-Packard)

* Equivalent measurement equipment may be used.

VLS5045EX-H type

SHAPE & DIMENSIONS

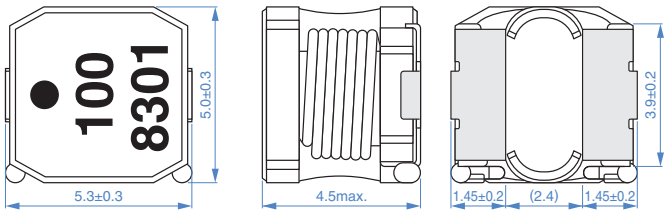

Dimensions in mm

PACKAGING STYLE

REEL DIMENSIONS

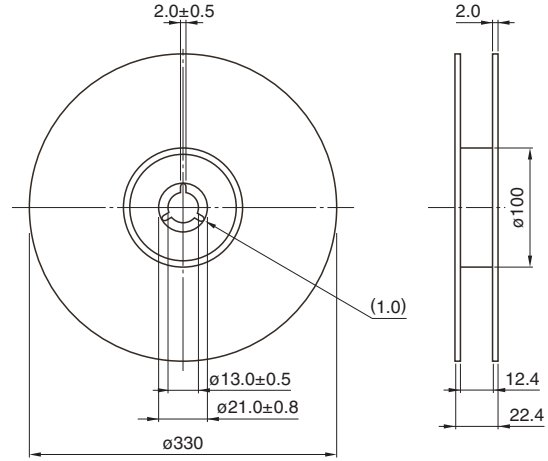

Dimensions in mm

RECOMMENDED LAND PATTERN

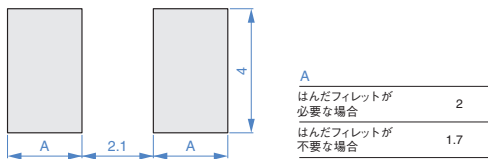

Dimensions in mm

TAPE DIMENSIONS

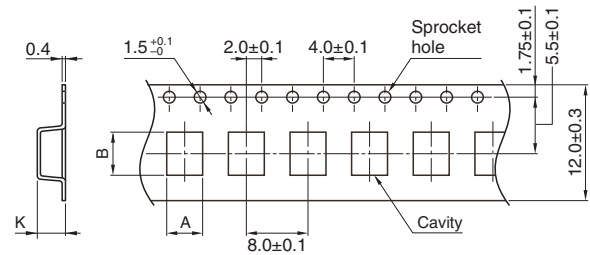

Dimensions in mm

Type	A	B	K
VLS5045EX-H	5.3	5.3	4.7

RECOMMENDED REFLOW PROFILE

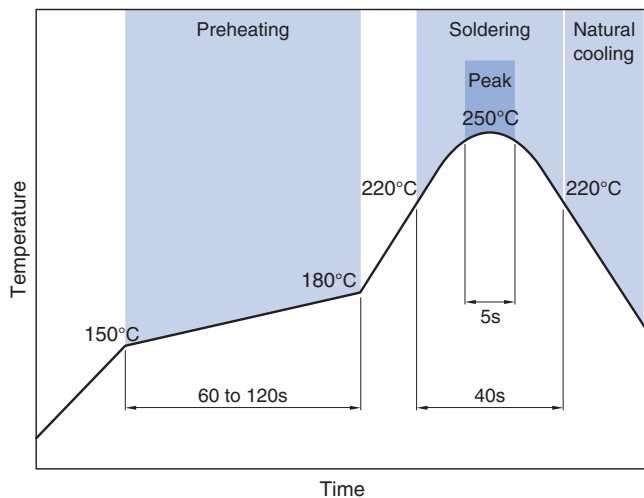

PACKAGE QUANTITY

Package quantity	1500 pcs/reel
------------------	---------------

X-ON Electronics

Largest Supplier of Electrical and Electronic Components

Click to view similar products for [Fixed Inductors](#) category:

Click to view products by [TDK](#) manufacturer:

Other Similar products are found below :

[MLZ1608M6R8WTD25](#) [MLZ1608N6R8LT000](#) [MLZ1608N3R3LTD25](#) [MLZ1608N3R3LT000](#) [MLZ1608N150LT000](#)
[MLZ1608M150WTD25](#) [MLZ1608M3R3WTD25](#) [MLZ1608M3R3WT000](#) [MLZ1608M150WT000](#) [MLZ1608A1R5WT000](#)
[MLZ1608N1R5LT000](#) [B82432C1333K000](#) [PCMB053T-1R0MS](#) [PCMB053T-1R5MS](#) [PCMB104T-1R5MS](#) [CR32NP-100KC](#) [CR32NP-151KC](#) [CR32NP-180KC](#) [CR32NP-181KC](#) [CR32NP-1R5MC](#) [CR32NP-390KC](#) [CR32NP-3R9MC](#) [CR32NP-680KC](#) [CR32NP-820KC](#)
[CR32NP-8R2MC](#) [CR43NP-390KC](#) [CR43NP-560KC](#) [CR43NP-680KC](#) [CR54NP-181KC](#) [CR54NP-470LC](#) [CR54NP-820KC](#) [CR54NP-8R5MC](#)
[MGDQ4-00004-P](#) [MGDU1-00016-P](#) [MHL1ECTTP18NJ](#) [MHL1JCTTD12NJ](#) [PE-51506NL](#) [PE-53601NL](#) [PE-53630NL](#) [PE-53824SNLT](#) [PE-62892NL](#) [PE-92100NL](#) [PG0434.801NLT](#) [PG0936.113NLT](#) [PM06-2N7](#) [PM06-39NJ](#) [HC2LP-R47-R](#) [HC2-R47-R](#) [HC3-2R2-R](#) [HC8-1R2-R](#)