

# **NTC thermistors for inrush current limiting**

Leaded and coated disks

**Series/Type:** B57153S0\*\*\*M0\*\*

**Date:** November 2015

© EPCOS AG 2015. Reproduction, publication and dissemination of this publication, enclosures hereto and the information contained therein without EPCOS' prior express consent is prohibited.

EPCOS AG is a TDK Group Company.

### Applications

- Inrush current limiting, e.g. in switch-mode power supplies, soft-start motors

### Features

- Leaded and coated NTC thermistors
- Tinned copper wire, kinked
- Coating material flame retardant to UL 94 V-0
- Component marking includes the manufacturer's logo, resistance value and date code
- Highly stable electrical characteristics

### Approvals

- UL 1434 (file number E69802)
- IEC (certificate number 101QA12)
- VDE (certificate number 40038223)
- CQC (0900104539)

### Options

Resistance tolerance <20% and alternative lead configurations available on request

### Delivery mode

Bulk (standard), cardboard tape on reel or Ammo pack

### General technical data

Climatic category	(IEC 60068-1)		55/170/21	
Max. power	(at 25 °C)	$P_{max}$	1.4	W
Resistance tolerance		$\Delta R_R/R_R$	±20	%
Rated temperature		$T_R$	25	°C
Dissipation factor	(in air)	$\delta_{th}$	approx. 8	mW/K
Thermal cooling time constant	(in air)	$\tau_c$	approx. 30	s
Heat capacity		$C_{th}$	approx. 240	mJ/K

### Dimensional drawing

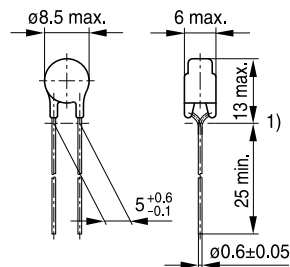

1) Seating plane to IEC 60717

ICL0036-Y-E

Dimensions in mm

Approx. weight 0.6 g

**Electrical specification and ordering codes**

$R_{25}$ $\Omega$	$I_{max}$ (0...65 °C) A	$C_{test}^{(1)}$ 230 V AC $\mu F$	$C_{test}^{(1)}$ 110 V AC $\mu F$	$R_{min}$ (@ $I_{max}$ , 25 °C) $\Omega$	Ordering code
4.7	3	100	400	0.154	B57153S0479M0**
8	2.2	100	400	0.279	B57153S0809M0**
10	2	100	400	0.340	B57153S0100M0**
15	1.8	100	400	0.430	B57153S0150M0**
16	1.7	100	400	0.473	B57153S0160M0**
20	1.6	100	400	0.528	B57153S0200M0**
33	1.3	100	400	0.832	B57153S0330M0**

\*\* = Delivery mode

00 = Bulk

51 = Reel packing

54 = Ammo packing

1) For details on the capacitance  $C_{test}$  please refer to "Application notes", chapter 1.6.

**Reliability data**

Test	Standard	Test conditions	$\Delta R_{25}/R_{25}$ (typical)	Remarks
Storage in dry heat	IEC 60068-2-2	Storage at upper category temperature T: 170 °C t: 1000 h	< 20%	No visible damage
Storage in damp heat, steady state	IEC 60068-2-78	Temperature of air: 40 °C Relative humidity of air: 93% Duration: 21 days	< 20%	No visible damage
Thermal shock	IEC 60068-2-14	Lower test temperature: -55 °C t: 30 min Upper test temperature: 170 °C t: 30 min Time to change from lower to upper temperature: < 30 s Number of cycles: 10	< 20%	No visible damage
Endurance	IEC 60539-1	Ambient temperature: 25 ±5 °C I = I <sub>max</sub> t: 1000 h	< 20%	No visible damage
Cyclic endurance	IEC 60539-1	Ambient temperature: 25 ±5 °C I = I <sub>max</sub> On-time = 1 min Cooling time = 5 min Number of cycles: 1000	< 20%	No visible damage
Maximum permissible capacitance test	IEC 60539-1	Ambient temperature: 25 ±5 °C Capacitance = C <sub>test</sub> Number of cycles: 1000	< 20%	No visible damage

**Note**

- The self-heating of a thermistor during operation depends on the load applied and the applicable dissipation factor.
- When loaded with maximum allowable current/power and the specified dissipation factor is taken as a basis, the NTC thermistor may reach a mean temperature of up to 250 °C.
- The heat developed during operation will also be dissipated through the lead wires. So the contact areas, too, may become quite hot at maximum load.
- When mounting NTC thermistors you have to ensure that there is an adequate distance between the thermistor and all parts which are sensitive to heat or combustible.

**Resistance versus temperature**

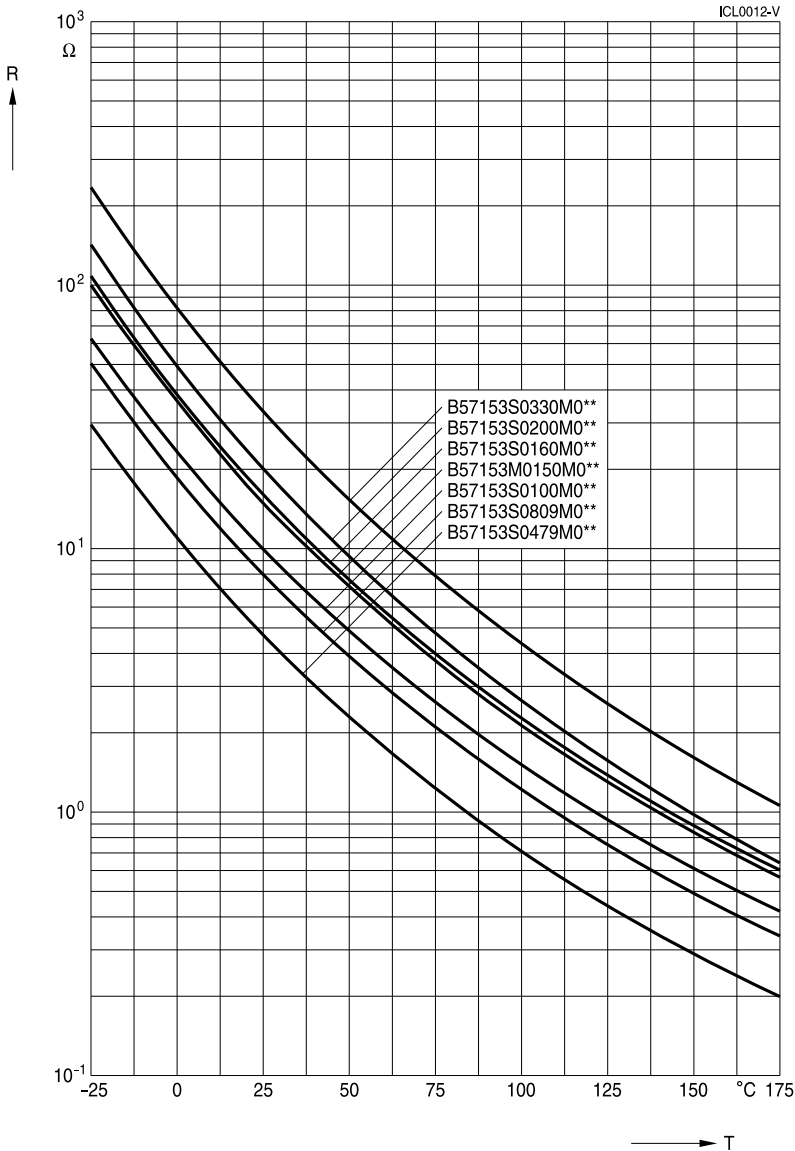

**S153 series**

**Resistance versus current**

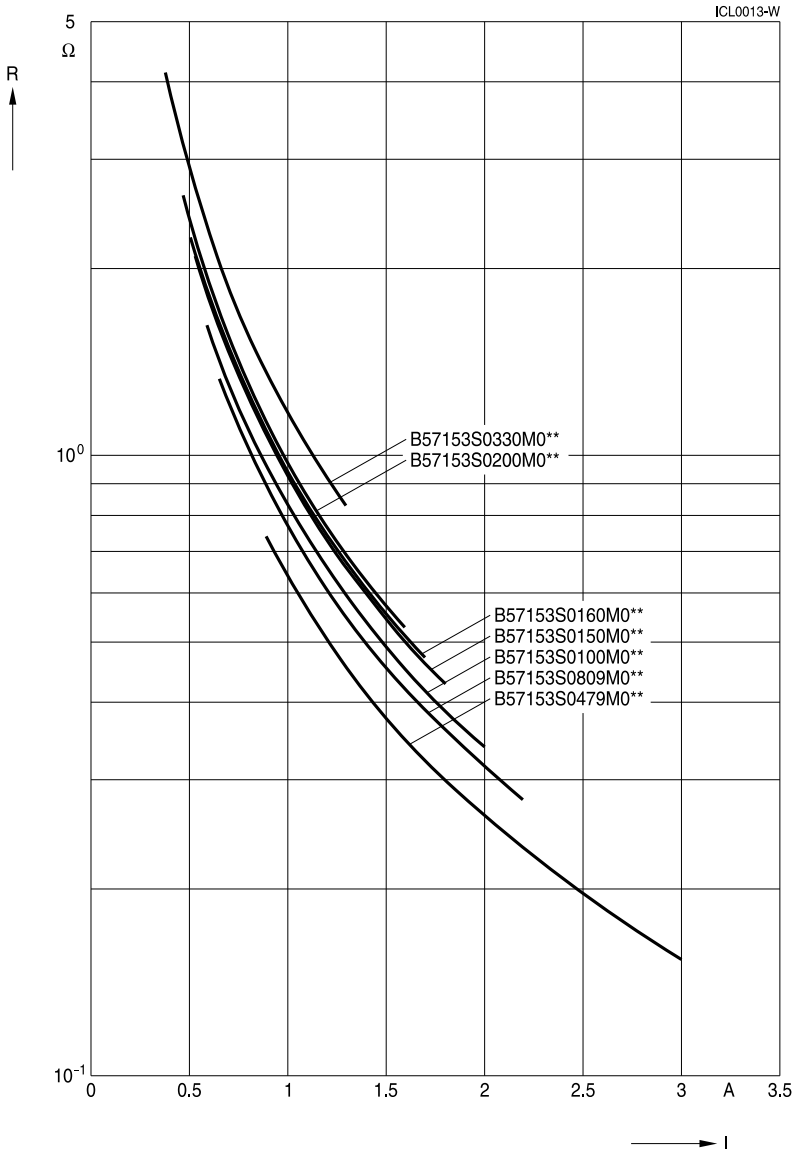

**S153 series**

## Application notes

The following two important aspects for determining the right NTC inrush current limiter are excerpted from the chapter "Application notes" in the "NTC Inrush Current Limiters, Data book 2012". The complete application note can be downloaded from [www.epcos.com/ntcicl\\_apnotes](http://www.epcos.com/ntcicl_apnotes).

### 1.4 Load derating

The power handling capability of an NTC thermistor cannot be fully utilized over the entire temperature range. For circuit dimensioning the derating curve given below provides information on the extent to which the current must be reduced at a certain ambient temperature ( $T_A$ ).

#### Derating curve for types S237, P11 and P13



$$\text{Percent of } I_{\max} = 100 \left[ 1 - \frac{T_A - 25 \text{ } ^\circ\text{C}}{T_{\max} - 25 \text{ } ^\circ\text{C}} \right]$$

$T_A$  = Ambient temperature > 25 °C

$T_{\max}$  = 170 °C

#### Derating curve for types S153, S235, S236, S238, S364 and S464

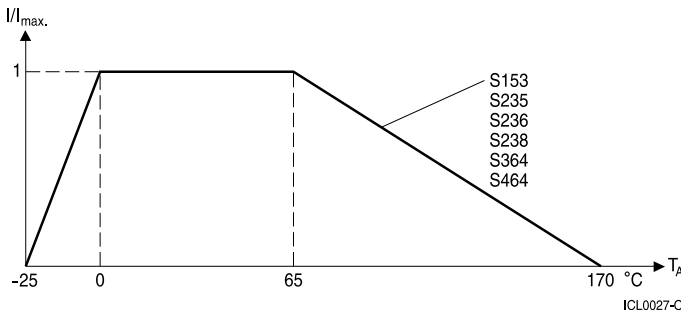

$$\text{Percent of } I_{\max} = 100 \left[ 1 - \frac{T_A - 65 \text{ }^\circ\text{C}}{T_{\max} - 65 \text{ }^\circ\text{C}} \right]$$

$T_A$  = Ambient temperature > 65 °C

$T_{\max}$  = 170 °C

The  $I_{\max}$  values specified in the data sheets denote the maximum permissible continuous current (DC or RMS values for sine-shaped AC) in the temperature range 0 °C to 65 °C.

### 1.6 Maximum permissible capacitance

The currents during turn-on are much higher than the rated currents during continuous operation. To test the effects of these current surges EPCOS uses the following standard procedure according to IEC 60539-1:

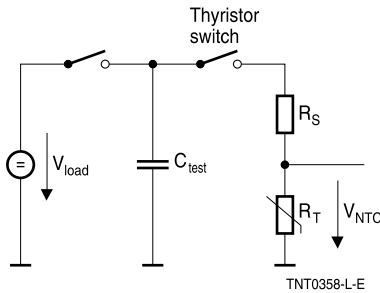

Figure 3

Test circuit for evaluating the maximum permissible capacitance of an NTC thermistor

- $V_{\text{load}}$  Load voltage [V]
- $C_{\text{test}}$  Test capacitance [ $\mu\text{F}$ ]
- $R_S$  Series resistance [ $R_S = 1 \text{ } \Omega$ ]
- $V_{\text{NTC}}$  Voltage drop across the NTC under test [V]

The capacitor  $C_{\text{test}}$  is discharged via the series resistor  $R_S$  and the NTC inrush current limiter. The load voltage is chosen such that the voltage applied to the thermistor at the start of discharge is  $V_{\text{NTC}} = 375 \text{ V}$  (corresponds to  $(230 \text{ V} + \Delta V) \cdot \sqrt{2}$ ).





Figure 4  
Maximum permissible capacitance discharging test: typical curves

The maximum capacitances that can be switched depend on the individual thermistor type and are given in the data sheets.

**Taping and packing**

**1 Taping of radial leaded ICL NTC thermistors according to the specified lead spacing**

**Dimensions and tolerances**

**Lead spacing  $F = 5.0 \text{ mm}$**  (taping to IEC 60286-2)

for the following types: S153, S235 and S236



**Lead spacing  $F = 7.5 \text{ mm}$**  (taping based on IEC 60286-2)

for the following types: P11, P13, S237, S238 and S364

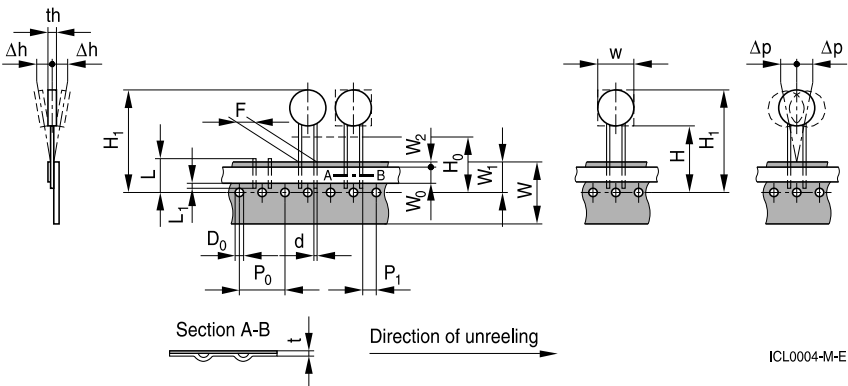

**Dimensions (mm)**

	Lead spacing 5 mm	Tolerance of lead spacing 5 mm	Lead spacing 7.5 mm	Tolerance of lead spacing 7.5 mm	Remarks
w	≤12.0		≥12.0		please refer to dimensional drawings
th	6.0	max.	7	max.	please refer to dimensional drawings
d	0.5/0.6	±0.05	0.8/1.0	±0.05	please refer to dimensional drawings
P <sub>0</sub>	12.7	±0.3	12.7	±0.3	±1 mm / 20 sprocket holes
P <sub>1</sub>	3.85	±0.7	8.95	±0.8	
F	5.0	+0.6/-0.1	7.5	±0.8	
Δh	0	±2.0	0	Depends on th	measured at top of component body
Δp	0	±1.3	0	±2.0	
W	18.0	±0.5	18.0	±0.5	
W <sub>0</sub>	5.5	min.	11.0	min.	peel-off force ≥5 N
W <sub>1</sub>	9.0	+0.75/-0.5	9.0	+0.75/-0.5	
W <sub>2</sub>	3.0	max.	3.0	max.	
H	18.0	+2.0/-0	18.0	+2.0/-0	applies only to uncrimped types
H <sub>0</sub>	16.0	±0.5	16.0	±0.5	applies only to crimped types
H <sub>1</sub>	32.2	max.	45.0	max.	
D <sub>0</sub>	4.0	±0.2	4.0	±0.2	
t	0.9	max.	0.9	max.	without wires
L	11.0	max.	11.0	max.	
L <sub>1</sub>	4.0	max.	4.0	max.	

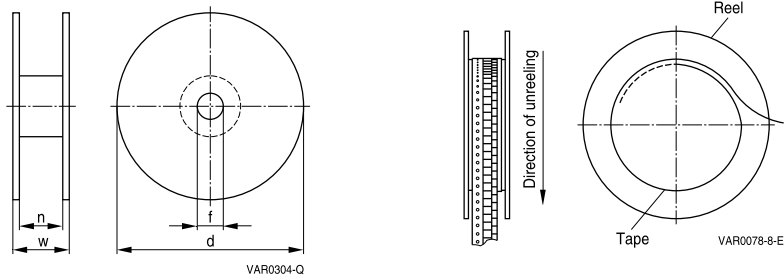
**Types of packing**
**Reel packing**

**Reel dimensions (in mm)**

Reel type	Series	pcs. per reel	d	f	n	w
I	S153, S235	1500	360 max.	31 ±1	approx. 45	54 max.
I	S236	1000	360 max.	31 ±1	approx. 45	54 max.
II	P11, P13	1500	500 max.	23 ±1	approx. 59	72 max.
II	S237, S238, S364	1000	500 max.	23 ±1	approx. 59	72 max.

**Ammo packing**

Ammo type	Series	pcs. per package	x	y	z
I	S153, S235, S236	1000	45	335	272
II	P11, P13, S237, S238, S364	750	55	340	340

**Ammo packing dimensions (in mm)**
**Bulk packing**

The components are packed in cardboard boxes, the size of which depends on the order quantity. Series S464 and P27 is only available as bulk.

## Mounting instructions

### 1 Soldering

#### 1.1 Leaded NTC thermistors

Leaded thermistors comply with the solderability requirements specified by CECC.

When soldering, care must be taken that the NTC thermistors are not damaged by excessive heat. The following maximum temperatures, maximum time spans and minimum distances have to be observed:

	<i>Dip soldering</i>	<i>Iron soldering</i>
Bath temperature	max. 260 °C	max. 360 °C
Soldering time	max. 4 s	max. 2 s
Distance from thermistor	min. 6 mm	min. 6 mm

Under more severe soldering conditions the resistance may change.

#### **Solderability** (test to IEC 60068-2-20)

Preconditioning: Immersion into flux F-SW 32.

Evaluation criterion: Wetting of soldering areas  $\geq 95\%$ .

Solder	Bath temperature (°C)	Dwell time (s)
SnAg (3.0 ... 4.0), Cu (0.5 ... 0.9)	245 ±3	3

#### 1.1.1 Resistance to soldering heat (test to IEC 60068-2-20)

Preconditioning: Immersion into flux F-SW 32.

Solder	Bath temperature (°C)	Dwell time (s)
SnAg (3.0 ... 4.0), Cu (0.5 ... 0.9)	260 –5	10

### 1.1.2 Wave soldering

Temperature characteristic at component terminal with dual wave soldering

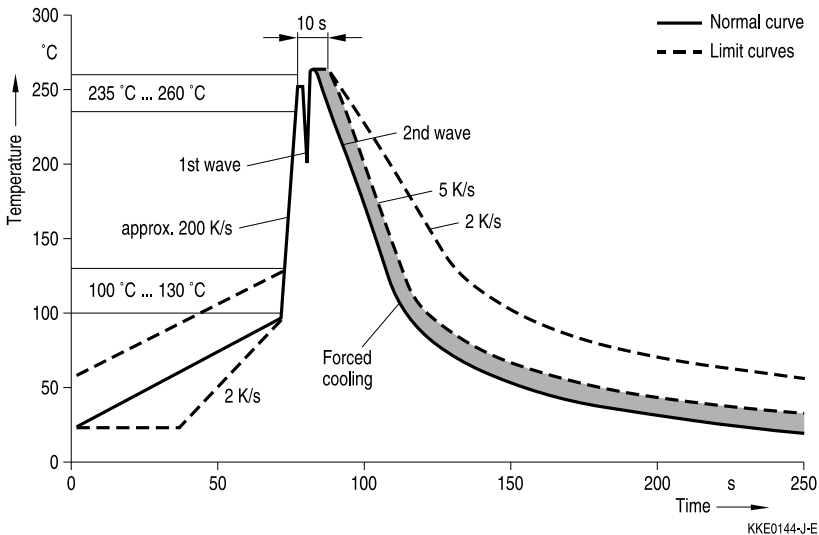

## 2 Robustness of terminations

The leads meet the requirements of IEC 60068-2-21. They may not be bent closer than 4 mm from the solder joint on the thermistor body or from the point at which they leave the feed-throughs. During bending, any mechanical stress at the outlet of the leads must be removed. The bending radius should be at least 0.75 mm.

Tensile strength: Test Ua1:

Leads	$0.50 < \varnothing \leq 0.80 \text{ mm} = 10.0 \text{ N}$
	$0.80 < \varnothing \leq 1.25 \text{ mm} = 20.0 \text{ N}$

Bending strength: Test Ub:

Two 90°-bends in opposite directions at a weight of 0.25 kg.

Torsional strength: Test Uc: severity 2

The lead is bent by 90° at a distance of 6 to 6.5 mm from the thermistor body.

The bending radius of the leads should be approx. 0.75 mm. Two torsions of 180° each (severity 2).

When subjecting leads to mechanical stress, the following should be observed:

*Tensile stress on leads*

During mounting and operation tensile forces on the leads are to be avoided.

*Bending of leads*

Bending of the leads directly on the thermistor body is not permissible.

A lead may be bent at a minimum distance of twice the wire's diameter +2 mm from the solder joint on the thermistor body. During bending the wire must be mechanically relieved at its outlet. The bending radius should be at least 0.75 mm.

*Twisting of leads*

The twisting (torsion) by 180° of a lead bent by 90° is permissible at 6 mm from the bottom of the thermistor body.

### 3 Sealing and potting

When thermistors are sealed, potted or overmolded, there must be no mechanical stress caused by thermal expansion during the production process (curing / overmolding process) and during later operation. The upper category temperature of the thermistor must not be exceeded. Ensure that the materials used (sealing / potting compound and plastic material) are chemically neutral.

### 4 Cleaning

If cleaning is necessary, mild cleaning agents such as ethyl alcohol and cleaning gasoline are recommended. Cleaning agents based on water are not allowed. Ultrasonic cleaning methods are permissible.

### 5 Storage

In order to maintain their solderability, thermistors must be stored in a non-corrosive atmosphere. Humidity, temperature and container materials are critical factors.

The components should be left in the original packing. Touching the metallization of unsoldered thermistors may change their soldering properties.

Storage temperature: –25 °C up to 45 °C

Max. relative humidity (without condensation): <95%, maximum 30 days per annum

Solder the thermistors listed in this data book after shipment from EPCOS within the time specified:

Leaded components: 24 months

## Cautions and warnings

### General

See "Important notes" on page 2.

### Storage

- Store thermistors only in original packaging. Do not open the package before storage.
- Storage conditions in original packaging: storage temperature  $-25\text{ }^{\circ}\text{C} \dots +45\text{ }^{\circ}\text{C}$ , relative humidity  $\leq 75\%$  annual mean, maximum 95%, dew precipitation is inadmissible.
- Avoid contamination of thermistors surface during storage, handling and processing.
- Avoid storage of thermistor in harmful environments like corrosive gases ( $\text{SO}_x$ , Cl etc).
- Solder thermistors after shipment from EPCOS within the time specified:
  - Leaded components: 24 months

### Handling

- NTC inrush current limiters must not be dropped. Chip-offs must not be caused during handling of NTC inrush current limiters.
- Components must not be touched with bare hands. Gloves are recommended.
- Avoid contamination of thermistor surface during handling.
- In case of exposure of the NTC inrush current limiters to water, electrolytes or other aggressive media, these media can penetrate the coating and reach the surface of the ceramic. Low-ohmic or high-ohmic behavior may occur due to the formation of an electrolyte with metals (silver/lead/tin from metallization or solder). Low-ohmic behavior is caused by electrochemical migration, high-ohmic behavior by dissolving of the electrode. In either case, the functionality of the NTC inrush current limiters can not be assured.
- Washing processes may damage the product due to the possible static or cyclic mechanical loads (e.g. ultrasonic cleaning). They may cause cracks to develop on the product and its parts, which might lead to reduced reliability or lifetime.

### Bending / twisting leads

- A lead (wire) may be bent at a minimum distance of twice the wire's diameter plus 4 mm from the component head or housing. When bending ensure the wire is mechanically relieved at the component head or housing. The bending radius should be at least 0.75 mm.
- Twisting (torsion) by  $180^{\circ}$  of a lead bent by  $90^{\circ}$  is permissible at 6 mm from the bottom of the thermistor body.

### Soldering

- Use resin-type flux or non-activated flux.
- Insufficient preheating may cause ceramic cracks.
- Rapid cooling by dipping in solvent is not recommended.
- Complete removal of flux is recommended.



## Mounting

- When NTC inrush current limiters are encapsulated with sealing material or overmolded with plastic material, the precautions given in chapter "Mounting instructions", "Sealing and potting" must be observed.
- Electrode must not be scratched before/during/after the mounting process.
- Contacts and housings used for assembly with thermistor have to be clean before mounting.
- During operation, the inrush current limiters surface temperature can be very high. Ensure that adjacent components are placed at a sufficient distance from the thermistor to allow for proper cooling of the NTC inrush current limiters.
- Ensure that adjacent materials are designed for operation at temperatures comparable to the surface temperature of the thermistor. Be sure that surrounding parts and materials can withstand this temperature.
- Make sure that inrush current limiters are adequately ventilated to avoid overheating.
- Avoid contamination of thermistor surface during processing.

## Operation

- Use NTC inrush current limiters only within the specified operating temperature range.
- Use NTC inrush current limiters only within the specified voltage and current ranges.
- Environmental conditions must not harm the NTC inrush current limiters. Use NTC inrush current limiters only in normal atmospheric conditions.
- Contact of NTC inrush current limiters with any liquids and solvents should be prevented. It must be ensured that no water enters the NTC inrush current limiters (e.g. through plug terminals). For measurement purposes (checking the specified resistance vs. temperature), the component must not be immersed in water but in suitable liquids (e.g. Galden).
- In case of exposure of the NTC inrush current limiters to water, electrolytes or other aggressive media, these media can penetrate the coating and reach the surface of the ceramic. Low-ohmic or high-ohmic behavior may occur due to the formation of an electrolyte with metals (silver/lead/tin from metallization or solder). Low-ohmic behavior is caused by electrochemical migration, high-ohmic behavior by dissolving of the electrode. In either case, the functionality of the NTC inrush current limiters can not be assured.
- Be sure to provide an appropriate fail-safe function to prevent secondary product damage caused by malfunction (e.g. use a metal oxide varistor for limitation of overvoltage condition).

This listing does not claim to be complete, but merely reflects the experience of EPCOS AG.

## Display of ordering codes for EPCOS products

The ordering code for one and the same EPCOS product can be represented differently in data sheets, data books, other publications, on the EPCOS website, or in order-related documents such as shipping notes, order confirmations and product labels. **The varying representations of the ordering codes are due to different processes employed and do not affect the specifications of the respective products.** Detailed information can be found on the Internet under [www.epcos.com/orderingcodes](http://www.epcos.com/orderingcodes)

**Symbols and terms**

Symbol	English
B	B value
$C_{\text{test}}$	Test capacitance
$C_{\text{th}}$	Heat capacitance
I	Current
$I_{\text{max}}$	Maximum current within stated temperature range
$I_{\text{NTC}}$	NTC current
$I_{\text{test}}$	High test current for additional endurance tests
$P_{\text{max}}$	Maximum power within stated temperature range
$R_{\text{min}}$	Minimum resistance
$R_{\text{R}}$	Rated resistance
$\Delta R_{\text{R}}/R_{\text{R}}$	Resistance tolerance
$R_{\text{S}}$	Series resistance
$R_{\text{T}}$	Resistance at temperature T (e.g. $R_{25}$ = resistance at 25 °C)
T	Temperature
t	Time
$T_{\text{A}}$	Ambient temperature
$t_{\text{a}}$	Thermal threshold time
$T_{\text{max}}$	Upper category temperature
$T_{\text{min}}$	Lower category temperature
$T_{\text{R}}$	Rated temperature
V	Voltage
$V_{\text{load}}$	Load voltage
$V_{\text{NTC}}$	Voltage drop across an NTC thermistor
$\alpha$	Temperature coefficient
$\Delta$	Tolerance, change
$\delta_{\text{th}}$	Dissipation factor
$\tau_{\text{c}}$	Thermal cooling time constant

**Abbreviations / Notes**

Symbol	English
*	To be replaced by a number in ordering codes, type designations etc.
+	To be replaced by a letter. All dimensions are given in mm. The commas used in numerical values denote decimal points.

## Important notes

The following applies to all products named in this publication:

1. Some parts of this publication contain **statements about the suitability of our products for certain areas of application**. These statements are based on our knowledge of typical requirements that are often placed on our products in the areas of application concerned. We nevertheless expressly point out **that such statements cannot be regarded as binding statements about the suitability of our products for a particular customer application**. As a rule, EPCOS is either unfamiliar with individual customer applications or less familiar with them than the customers themselves. For these reasons, it is always ultimately incumbent on the customer to check and decide whether an EPCOS product with the properties described in the product specification is suitable for use in a particular customer application.
2. We also point out that **in individual cases, a malfunction of electronic components or failure before the end of their usual service life cannot be completely ruled out in the current state of the art, even if they are operated as specified**. In customer applications requiring a very high level of operational safety and especially in customer applications in which the malfunction or failure of an electronic component could endanger human life or health (e.g. in accident prevention or lifesaving systems), it must therefore be ensured by means of suitable design of the customer application or other action taken by the customer (e.g. installation of protective circuitry or redundancy) that no injury or damage is sustained by third parties in the event of malfunction or failure of an electronic component.
3. **The warnings, cautions and product-specific notes must be observed.**
4. In order to satisfy certain technical requirements, **some of the products described in this publication may contain substances subject to restrictions in certain jurisdictions (e.g. because they are classed as hazardous)**. Useful information on this will be found in our Material Data Sheets on the Internet ([www.epcos.com/material](http://www.epcos.com/material)). Should you have any more detailed questions, please contact our sales offices.
5. We constantly strive to improve our products. Consequently, **the products described in this publication may change from time to time**. The same is true of the corresponding product specifications. Please check therefore to what extent product descriptions and specifications contained in this publication are still applicable before or when you place an order. We also **reserve the right to discontinue production and delivery of products**. Consequently, we cannot guarantee that all products named in this publication will always be available. The aforementioned does not apply in the case of individual agreements deviating from the foregoing for customer-specific products.
6. Unless otherwise agreed in individual contracts, **all orders are subject to the current version of the "General Terms of Delivery for Products and Services in the Electrical Industry" published by the German Electrical and Electronics Industry Association (ZVEI)**.

## Important notes

7. The trade names EPCOS, Alu-X, CeraDiode, CeraLink, CeraPad, CeraPlas, CSMP, CSSP, CTVS, DeltaCap, DigiSiMic, DSSP, ExoCore, FilterCap, FormFit, LeaXield, MiniBlue, MiniCell, MKD, MKK, MotorCap, PCC, PhaseCap, PhaseCube, PhaseMod, PhiCap, PQSine, SIFERRIT, SIFI, SIKOREL, SilverCap, SIMDAD, SiMic, SIMID, SineFormer, SIOV, SIP5D, SIP5K, TFAP, ThermoFuse, WindCap are **trademarks registered or pending** in Europe and in other countries. Further information will be found on the Internet at [www.epcos.com/trademarks](http://www.epcos.com/trademarks).

## X-ON Electronics

Largest Supplier of Electrical and Electronic Components

*Click to view similar products for [Inrush Current Limiters](#) category:*

*Click to view products by [TDK](#) manufacturer:*

Other Similar products are found below :

[B57364S2509A002](#) [SL1580003](#) [MS15 15004](#) [MT8950AC](#) [B57364S121M](#) [SL22 20005-B](#) [B57237S0330M00](#) [AS35 1R040](#)  
[B57153S0809M000](#) [CL-120AB](#) [CL-130A](#) [CL-80AB](#) [CL-140AB](#) [B57238S0160M000](#) [TG2512A](#) [AS32 0R530-100](#) [AS32 0R536-100](#) [AS32 10015](#) [AS32 1R036-100](#) [AS32 20010](#) [AS32 2R025](#) [AS32 50006](#) [AS32 5R020](#) [AS35 0R550](#) [AS35 20010](#) [MS15 30004](#) [MS15 40004](#) [MS22 10008-B](#) [MS22 12102](#) [MS22 12103](#) [MS22 20005](#) [MS22 22103](#) [MS22 75004](#) [MS32 0R536](#) [MS32 15012](#) [MS32 20008](#) [MS32 20010](#) [MS32 20010-B](#) [MS32 2R025](#) [MS32 50006](#) [MS32 50006-L](#) [MS32 5R020](#) [MS32 5R020-B](#) [MS32 7R015](#) [MS35 10018](#) [MS35 20010](#) [SG100](#) [SG110](#)  
[SG120](#) [SG140](#)