

DELIVERY SPECIFICATION

SPEC. No. C-General-h

D A T E : Jun, 2020

To

Non-Controlled Copy

CUSTOMER'S PRODUCT NAME

TDK'S PRODUCT NAME

Multilayer Ceramic Chip Capacitors
 Bulk and tape packaging 【RoHS compliant】
 C1005,C1608,C2012,C3216,C3225,
 C4532,C5750 Type
 C0G,CH,X5R,X6S,X7R,X7S,X7T,B Characteristics

Please return this specification to TDK representatives with your signature.
 If orders are placed without returned specification, please allow us to judge that specification is accepted by your side.

RECEIPT CONFIRMATION

DATE: _____ YEAR _____ MONTH _____ DAY _____

TDK Corporation
 Sales
 Electronic Components
 Sales & Marketing Group

Engineering
 Electronic Components Business Company
 Ceramic Capacitors Business Group

| | |
|----------|------------------|
| APPROVED | Person in charge |
| | |

| | | |
|----------|---------|------------------|
| APPROVED | CHECKED | Person in charge |
| | | |

■ CATALOG NUMBER CONSTRUCTION

| | | | | | | | | |
|----------|-------------|------------|-----------|------------|----------|------------|----------|----------|
| C | 3216 | X5R | 1A | 107 | M | 160 | A | C |
| (1) | (2) | (3) | (4) | (5) | (6) | (7) | (8) | (9) |

(1) Series

(2) Dimensions L x W (mm)

| Code | EIA | Length | Width | Terminal width |
|------|--------|--------|-------|----------------|
| 1005 | CC0402 | 1.00 | 0.50 | 0.10 |
| 1608 | CC0603 | 1.60 | 0.80 | 0.20 |
| 2012 | CC0805 | 2.00 | 1.25 | 0.20 |
| 3216 | CC1206 | 3.20 | 1.60 | 0.20 |
| 3225 | CC1210 | 3.20 | 2.50 | 0.20 |
| 4532 | CC1812 | 4.50 | 3.20 | 0.20 |
| 5750 | CC2220 | 5.70 | 5.00 | 0.20 |

(3) Temperature characteristics

| Temperature characteristics | Temperature coefficient or capacitance change | Temperature range |
|-----------------------------|---|-------------------|
| CH | 0±60 ppm/°C | -25 to +85°C |
| C0G | 0±30 ppm/°C | -55 to +125°C |
| JB | ±10% | -25 to +85°C |
| X5R | ±15% | -55 to +85°C |
| X6S | ±22% | -55 to +105°C |
| X7R | ±15% | -55 to +125°C |
| X7S | ±22% | -55 to +125°C |

(4) Rated voltage (DC)

| Code | Voltage (DC) |
|------|--------------|
| 0G | 4V |
| 0J | 6.3V |
| 1A | 10V |
| 1C | 16V |
| 1E | 25V |
| 1V | 35V |
| 1H | 50V |
| 1N | 75V |

(5) Nominal capacitance (pF)

The capacitance is expressed in three digit codes and in units of pico Farads (pF). The first and second digits identify the first and second significant figures of the capacitance. The third digit identifies the multiplier. R designates a decimal point.

(Example) 0R5 = 0.5pF
 101 = 100pF
 225 = 2,200,000pF = 2.2μF

(6) Capacitance tolerance

| Code | Tolerance |
|------|-----------|
| B | ±0.10pF |
| C | ±0.25pF |
| D | ±0.50pF |
| F | ±1% |
| G | ±2% |
| J | ±5% |
| K | ±10% |
| M | ±20% |

(7) Thickness

| Code | Thickness |
|------|-----------|
| 020 | 0.20mm |
| 030 | 0.30mm |
| 050 | 0.50mm |
| 060 | 0.60mm |
| 080 | 0.80mm |
| 085 | 0.85mm |
| 115 | 1.15mm |
| 125 | 1.25mm |
| 130 | 1.30mm |
| 160 | 1.60mm |
| 200 | 2.00mm |
| 230 | 2.30mm |
| 250 | 2.50mm |
| 280 | 2.80mm |
| 320 | 3.20mm |

(8) Packaging style

| Code | Style |
|------|-----------------------|
| A | 178mm reel, 4mm pitch |
| B | 178mm reel, 2mm pitch |
| K | 178mm reel, 8mm pitch |

(9) Special reserved code

| Code | Description |
|-------|-------------------|
| A,B,C | TDK internal code |

■ CATALOG NUMBER CONSTRUCTION

| | | | | | | | | |
|----------|-------------|------------|-----------|------------|----------|------------|----------|----------|
| C | 5750 | X7S | 2A | 226 | M | 280 | K | B |
| (1) | (2) | (3) | (4) | (5) | (6) | (7) | (8) | (9) |

(1) Series

(2) Dimensions L x W (mm)

| Code | EIA | Length | Width | Terminal width |
|------|--------|--------|-------|----------------|
| 1005 | CC0402 | 1.00 | 0.50 | 0.10 |
| 1608 | CC0603 | 1.60 | 0.80 | 0.20 |
| 2012 | CC0805 | 2.00 | 1.25 | 0.20 |
| 3216 | CC1206 | 3.20 | 1.60 | 0.20 |
| 3225 | CC1210 | 3.20 | 2.50 | 0.20 |
| 4532 | CC1812 | 4.50 | 3.20 | 0.20 |
| 5750 | CC2220 | 5.70 | 5.00 | 0.20 |

(3) Temperature characteristics

| Temperature characteristics | Temperature coefficient or capacitance change | Temperature range |
|-----------------------------|---|-------------------|
| CH | 0±60 ppm/°C | -25 to +85°C |
| C0G | 0±30 ppm/°C | -55 to +125°C |
| JB | ±10% | -25 to +85°C |
| X5R | ±15% | -55 to +85°C |
| X6S | ±22% | -55 to +105°C |
| X7R | ±15% | -55 to +125°C |
| X7S | ±22% | -55 to +125°C |
| X7T | +22,-33% | -55 to +125°C |

(4) Rated voltage (DC)

| Code | Voltage (DC) |
|------|--------------|
| 2A | 100V |
| 2E | 250V |
| 2V | 350V |
| 2W | 450V |
| 2J | 630V |

(5) Nominal capacitance (pF)

The capacitance is expressed in three digit codes and in units of pico Farads (pF). The first and second digits identify the first and second significant figures of the capacitance. The third digit identifies the multiplier. R designates a decimal point.

(Example) 0R5 = 0.5pF
 101 = 100pF
 225 = 2,200,000pF = 2.2μF

(6) Capacitance tolerance

| Code | Tolerance |
|------|-----------|
| C | ±0.25pF |
| D | ±0.50pF |
| F | ±1% |
| G | ±2% |
| J | ±5% |
| K | ±10% |
| M | ±20% |

(7) Thickness

| Code | Thickness |
|------|-----------|
| 050 | 0.50mm |
| 060 | 0.60mm |
| 080 | 0.80mm |
| 085 | 0.85mm |
| 115 | 1.15mm |
| 125 | 1.25mm |
| 130 | 1.30mm |
| 160 | 1.60mm |
| 200 | 2.00mm |
| 230 | 2.30mm |
| 250 | 2.50mm |
| 280 | 2.80mm |
| 320 | 3.20mm |

(8) Packaging style

| Code | Style |
|------|-----------------------|
| A | 178mm reel, 4mm pitch |
| B | 178mm reel, 2mm pitch |
| K | 178mm reel, 8mm pitch |

(9) Special reserved code

| Code | Description |
|---------|-------------------|
| A,B,C,N | TDK internal code |

SCOPE

This delivery specification shall be applied to Multilayer ceramic chip capacitors to be delivered to _____.

PRODUCTION PLACES

Production places defined in this specification shall be TDK Corporation, TDK(Suzhou)Co.,Ltd and TDK Components U.S.A.,Inc.

PRODUCT NAME

The name of the product to be defined in this specifications shall be C◇◇◇◇○○○△△□□□ ×.

REFERENCE STANDARD

- JIS C 5101 – 1 : 2010 Fixed capacitors for use in electronic equipment-Part 1: Generic specification
 C 5101 – 21 : 2014 Fixed capacitors for use in electronic equipment-Part 21 : Sectional specification : Fixed surface mount multilayer capacitors of ceramic dielectric,Class1
 C 5101 – 22 : 2014 Fixed capacitors for use in electronic equipment-Part 22 : Sectional specification : Fixed surface mount multilayer capacitors of ceramic dielectric,Class2
 C 0806 – 3 : 2014 Packaging of components for automatic handling - Part 3: Packaging of surface mount components on continuous tapes
 JEITA RCR – 2335 C 2014 Safety application guide for fixed ceramic capacitors for use in electronic equipment

CONTENTS

1. CODE CONSTRUCTION
2. COMBINATION OF RATED CAPACITANCE AND TOLERANCE
3. OPERATING TEMPERATURE RANGE
4. STORING CONDITION AND TERM
5. P.C. BOARD
6. INDUSTRIAL WASTE DISPOSAL
7. PERFORMANCE
8. INSIDE STRUCTURE AND MATERIAL
9. PACKAGING
10. RECOMMENDATION
11. SOLDERING CONDITION
12. CAUTION
13. TAPE PACKAGING SPECIFICATION

<EXPLANATORY NOTE>

When the mistrust in the spec arises, this specification is given priority. And it will be confirmed by written spec change after conference of both posts involved.

This specification warrants the quality of the ceramic chip capacitor. Capacitors should be evaluated or confirmed a state of mounted on your product.

If the use of the capacitors goes beyond the bounds of this specification, we can not afford to guarantee.

| Division | Date | SPEC. No. |
|-----------------------------------|-----------|-------------|
| Ceramic Capacitors Business Group | Jun, 2020 | C-general-h |

1. CODE CONSTRUCTION

(Example) C2012 X7R 1E 225 K T 0000
 (1) (2) (3) (4) (5) (6) (7)

(1) Case size

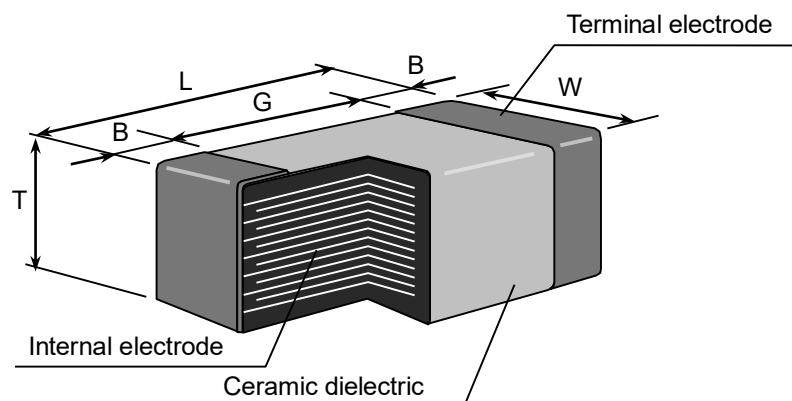

| Case size [EIA style] | Dimensions (mm) | | | | |
|--|--|--|--|-----------|-----------|
| | L | W | T | B | G |
| C1005 [CC0402] | 1.00±0.05 | 0.50±0.05 | 0.50±0.05 | 0.10 min. | 0.30 min. |
| | 1.00±0.10 | 0.50±0.10 | 0.50±0.10 | | |
| | 1.00 ^{+0.15} _{-0.10} | 0.50 ^{+0.15} _{-0.10} | 0.50 ^{+0.15} _{-0.10} | | |
| C1608 [CC0603] | 1.60±0.10 | 0.80±0.10 | 0.80±0.10 | 0.20 min. | 0.30 min. |
| | 1.60 ^{+0.15} _{-0.10} | 0.80 ^{+0.15} _{-0.10} | 0.80 ^{+0.15} _{-0.10} | | |
| | 1.60 ^{+0.20} _{-0.10} | 0.80 ^{+0.20} _{-0.10} | 0.80 ^{+0.20} _{-0.10} | | |
| C2012 [CC0805] | 2.00±0.20 | 1.25±0.20 | 0.60±0.15 | 0.20 min. | 0.50 min. |
| | | | 0.85±0.15 | | |
| | | | 1.25±0.20 | | |
| 2.00 ^{+0.25} _{-0.15} | 1.25 ^{+0.25} _{-0.15} | 1.25 ^{+0.25} _{-0.15} | | | |
| C3216 [CC1206] | 3.20±0.20 | 1.60±0.20 | 0.60±0.15 | 0.20 min. | 1.00 min. |
| | | | 0.85±0.15 | | |
| | | | 1.15±0.15 | | |
| | | | 1.30±0.20 | | |
| | | | 1.60±0.20 | | |
| 3.20 ^{+0.30} _{-0.10} | 1.60 ^{+0.30} _{-0.10} | 1.60 ^{+0.30} _{-0.10} | | | |
| C3225 [CC1210] | 3.20±0.40 | 2.50±0.30 | 1.25±0.20 | 0.20 min. | — |
| | | | 1.60±0.20 | | |
| | | | 2.00±0.20 | | |
| | | | 2.30±0.20 | | |
| | | | 2.50±0.30 | | |
| 3.20 ^{+0.45} _{-0.40} | 2.50 ^{+0.35} _{-0.30} | 2.50 ^{+0.35} _{-0.30} | | | |
| C4532 [CC1812] | 4.50±0.40 | 3.20±0.40 | 1.60±0.20 | 0.20 min. | — |
| | | | 2.00±0.20 | | |
| | | | 2.30±0.20 | | |
| | | | 2.50±0.30 | | |
| | | | 2.80±0.30 | | |
| 3.20±0.30 | | | | | |

* As for each item, please refer to detail page on TDK web.

| Case size [EIA style] | Dimensions (mm) | | | | |
|--------------------------|-----------------|-----------|-----------|-----------|---|
| | L | W | T | B | G |
| C5750 [CC2220] | 5.70±0.40 | 5.00±0.40 | 1.60±0.20 | 0.20 min. | — |
| | | | 2.00±0.20 | | |
| | | | 2.30±0.20 | | |
| | | | 2.50±0.30 | | |
| | | | 2.80±0.30 | | |

* As for each item, please refer to detail page on TDK web.

(2) Temperature Characteristics

* Details are shown in table 1 No.6 and No.7 at 7.PERFORMANCE

(3) Rated Voltage

| Symbol | Rated Voltage | Symbol | Rated Voltage |
|--------|---------------|--------|---------------|
| 2 J | DC 630 V | 1 V | DC 35 V |
| 2 W | DC 450 V | 1 E | DC 25 V |
| 2 V | DC 350 V | 1 C | DC 16 V |
| 2 E | DC 250 V | 1 A | DC 10 V |
| 2 A | DC 100 V | 0 J | DC 6.3 V |
| 1 N | DC 75 V | 0 G | DC 4 V |
| 1 H | DC 50 V | | |

(4) Rated Capacitance

Stated in three digits and in units of pico farads (pF).
The first and Second digits identify the first and second significant figures of the capacitance, the third digit identifies the multiplier.
R is designated for a decimal point.

(Example)

| Symbol | Rated Capacitance |
|--------|-------------------|
| 2R2 | 2.2 pF |
| 225 | 2,200,000 pF |

(5) Capacitance tolerance

* M tolerance shall be standard for over 10uF.

| Symbol | Tolerance | Capacitance |
|--------|-----------|----------------|
| C | ± 0.25 pF | 10pF and under |
| D | ± 0.5 pF | |
| J | ± 5 % | Over 10pF |
| K | ± 10 % | |
| * M | ± 20 % | |

(6) Packaging

* C1005 type is applicable to tape packaging only.

| Symbol | Packaging |
|--------|-----------|
| B | Bulk |
| T | Taping |

(7) TDK internal code

2. COMBINATION OF RATED CAPACITANCE AND TOLERANCE

| Class | Temperature Characteristics | Capacitance tolerance | | Rated capacitance |
|-------|--------------------------------------|-----------------------|--------------------------------------|-------------------------------|
| 1 | C0G CH | 10pF and under | C ($\pm 0.25\text{pF}$) | 1, 2, 3, 4, 5 |
| | | | D ($\pm 0.5\text{pF}$) | 6, 7, 8, 9, 10 |
| | | Over 10pF | J ($\pm 5\%$) | E – 6 series E – 12 series |
| 2 | X5R X6S X7R X7S X7T B | 10uF and under | K ($\pm 10\%$) M ($\pm 20\%$) | E – 6 series |
| | | Over 10uF | M ($\pm 20\%$) | |

Capacitance Step in E series

| E series | Capacitance Step | | | | | | | | | | | |
|----------|------------------|-----|-----|-----|-----|-----|-----|-----|-----|-----|-----|-----|
| E-6 | 1.0 | | 1.5 | | 2.2 | | 3.3 | | 4.7 | | 6.8 | |
| E-12 | 1.0 | 1.2 | 1.5 | 1.8 | 2.2 | 2.7 | 3.3 | 3.9 | 4.7 | 5.6 | 6.8 | 8.2 |

3. OPERATING TEMPERATURE RANGE

| T.C. | Min. operating Temperature | Max. operating Temperature | Reference Temperature |
|-----------------|----------------------------|----------------------------|-----------------------|
| CH/B | -25°C | 85°C | 20°C |
| X5R | -55°C | 85°C | 25°C |
| X6S | -55°C | 105°C | 25°C |
| C0G/X7R/X7S/X7T | -55°C | 125°C | 25°C |

4. STORING CONDITION AND TERM

| Storing temperature | Storing humidity | Storing term |
|---------------------|------------------|-------------------------------|
| 5~40°C | 20~70%RH | Within 6 months upon receipt. |

5. P.C. BOARD

When mounting on an aluminum substrate, large case sizes such as C3225[CC1210] and larger are more likely to be affected by heat stress from the substrate. Please inquire separate specification for the large case sizes when mounted on the substrate.

6. INDUSTRIAL WASTE DISPOSAL

Dispose this product as industrial waste in accordance with the Industrial Waste Law.

7. PERFORMANCE

table 1

| No. | Item | | Performance | Test or inspection method | | | | | | | | | | | | | | | | | |
|-------|-----------------------|---------------------|--|--|-------|-------------------|---------------|---|----------------|-------------------|-----------------------|---------------------|-------------|---------------------|---|----------------|---------------------|-----------------------|---------------------|-------------|---------------------|
| 1 | External Appearance | | No defects which may affect performance. | Inspect with magnifying glass (3×) | | | | | | | | | | | | | | | | | |
| 2 | Insulation Resistance | | Please refer to detail page on TDK web. | Measuring voltage : Rated voltage (As for the capacitor of rated voltage 630V DC, apply 500V DC.) Voltage application time : 60s. | | | | | | | | | | | | | | | | | |
| 3 | Voltage Proof | | Withstand test voltage without insulation breakdown or other damage. | <table border="1"> <thead> <tr> <th>Class</th> <th>Rated voltage(RV)</th> <th>Apply voltage</th> </tr> </thead> <tbody> <tr> <td rowspan="3">1</td> <td>$RV \leq 100V$</td> <td>3 × rated voltage</td> </tr> <tr> <td>$100V < RV \leq 500V$</td> <td>1.5 × rated voltage</td> </tr> <tr> <td>$500V < RV$</td> <td>1.3 × rated voltage</td> </tr> <tr> <td rowspan="3">2</td> <td>$RV \leq 100V$</td> <td>2.5 × rated voltage</td> </tr> <tr> <td>$100V < RV \leq 500V$</td> <td>1.5 × rated voltage</td> </tr> <tr> <td>$500V < RV$</td> <td>1.3 × rated voltage</td> </tr> </tbody> </table> <p>Voltage application time : 1s. Charge / discharge current : 50mA or lower</p> | Class | Rated voltage(RV) | Apply voltage | 1 | $RV \leq 100V$ | 3 × rated voltage | $100V < RV \leq 500V$ | 1.5 × rated voltage | $500V < RV$ | 1.3 × rated voltage | 2 | $RV \leq 100V$ | 2.5 × rated voltage | $100V < RV \leq 500V$ | 1.5 × rated voltage | $500V < RV$ | 1.3 × rated voltage |
| Class | Rated voltage(RV) | Apply voltage | | | | | | | | | | | | | | | | | | | |
| 1 | $RV \leq 100V$ | 3 × rated voltage | | | | | | | | | | | | | | | | | | | |
| | $100V < RV \leq 500V$ | 1.5 × rated voltage | | | | | | | | | | | | | | | | | | | |
| | $500V < RV$ | 1.3 × rated voltage | | | | | | | | | | | | | | | | | | | |
| 2 | $RV \leq 100V$ | 2.5 × rated voltage | | | | | | | | | | | | | | | | | | | |
| | $100V < RV \leq 500V$ | 1.5 × rated voltage | | | | | | | | | | | | | | | | | | | |
| | $500V < RV$ | 1.3 × rated voltage | | | | | | | | | | | | | | | | | | | |
| 4 | Capacitance | | Within the specified tolerance. | As for measuring condition, please contact with our sales representative. | | | | | | | | | | | | | | | | | |
| 5 | Q | Class1 | Please refer to detail page on TDK web. | See No.4 in this table for measuring condition. | | | | | | | | | | | | | | | | | |
| | Dissipation Factor | Class2 | | | | | | | | | | | | | | | | | | | |

(continued)

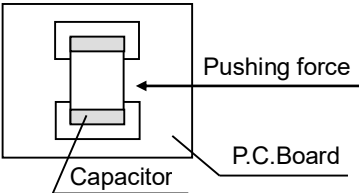
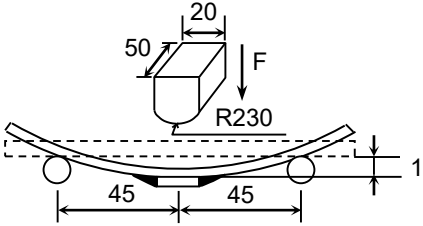
| No. | Item | Performance | Test or inspection method | | | | | | | | | | | | | | | | | | | | | |
|------------------------|---|---|---|----------------------------------|--------------------|----------------------|-----------|---|-------------------|--|--|-------------------|---------|---|------|-----------------|---|---------------------|---|--------------------------|---|---------------------|---|--------------------------|
| 6 | Temperature Characteristics of Capacitance (Class1) | <table border="1"> <tr> <td>T.C.</td> <td>Temperature Coefficient (ppm/°C)</td> </tr> <tr> <td>C0G</td> <td>0 ± 30</td> </tr> <tr> <td>CH</td> <td>0 ± 60</td> </tr> <tr> <td>Capacitance drift</td> <td>Within ± 0.2% or ± 0.05pF, whichever larger.</td> </tr> </table> | T.C. | Temperature Coefficient (ppm/°C) | C0G | 0 ± 30 | CH | 0 ± 60 | Capacitance drift | Within ± 0.2% or ± 0.05pF, whichever larger. | <p>Temperature coefficient shall be calculated based on values at 25°C(CH:20°C) and 85°C temperature.</p> <p>Measuring temperature below 25°C(CH:20°C) shall be -10°C and -25°C.</p> | | | | | | | | | | | | | |
| T.C. | Temperature Coefficient (ppm/°C) | | | | | | | | | | | | | | | | | | | | | | | |
| C0G | 0 ± 30 | | | | | | | | | | | | | | | | | | | | | | | |
| CH | 0 ± 60 | | | | | | | | | | | | | | | | | | | | | | | |
| Capacitance drift | Within ± 0.2% or ± 0.05pF, whichever larger. | | | | | | | | | | | | | | | | | | | | | | | |
| 7 | Temperature Characteristics of Capacitance (Class2) | <table border="1"> <tr> <th colspan="2">Capacitance Change (%)</th> </tr> <tr> <th>No voltage applied</th> <th>With voltage Applied</th> </tr> <tr> <td>X5R : ±15</td> <td rowspan="6">Please contact with our sales representative.</td> </tr> <tr> <td>X6S : ±22</td> </tr> <tr> <td>X7R : ±15</td> </tr> <tr> <td>X7S : ±22</td> </tr> <tr> <td>X7T : +22 - 33</td> </tr> <tr> <td>B : ±10</td> </tr> </table> | Capacitance Change (%) | | No voltage applied | With voltage Applied | X5R : ±15 | Please contact with our sales representative. | X6S : ±22 | X7R : ±15 | X7S : ±22 | X7T : +22 - 33 | B : ±10 | <p>Capacitance shall be measured by the steps shown in the following table after thermal equilibrium is obtained for each step. ΔC be calculated ref. STEP3 reading</p> <table border="1"> <tr> <th>Step</th> <th>Temperature(°C)</th> </tr> <tr> <td>1</td> <td>Reference temp. ± 2</td> </tr> <tr> <td>2</td> <td>Min. operating temp. ± 2</td> </tr> <tr> <td>3</td> <td>Reference temp. ± 2</td> </tr> <tr> <td>4</td> <td>Max. operating temp. ± 2</td> </tr> </table> <p>As for Min./Max. operating temp and Reference temp., please refer to "3. OPERATING TEMPERATURE RANGE" Apply a voltage of 1/2 rated voltage. As for measuring voltage, please contact with our sales representative.</p> | Step | Temperature(°C) | 1 | Reference temp. ± 2 | 2 | Min. operating temp. ± 2 | 3 | Reference temp. ± 2 | 4 | Max. operating temp. ± 2 |
| Capacitance Change (%) | | | | | | | | | | | | | | | | | | | | | | | | |
| No voltage applied | With voltage Applied | | | | | | | | | | | | | | | | | | | | | | | |
| X5R : ±15 | Please contact with our sales representative. | | | | | | | | | | | | | | | | | | | | | | | |
| X6S : ±22 | | | | | | | | | | | | | | | | | | | | | | | | |
| X7R : ±15 | | | | | | | | | | | | | | | | | | | | | | | | |
| X7S : ±22 | | | | | | | | | | | | | | | | | | | | | | | | |
| X7T : +22 - 33 | | | | | | | | | | | | | | | | | | | | | | | | |
| B : ±10 | | | | | | | | | | | | | | | | | | | | | | | | |
| Step | Temperature(°C) | | | | | | | | | | | | | | | | | | | | | | | |
| 1 | Reference temp. ± 2 | | | | | | | | | | | | | | | | | | | | | | | |
| 2 | Min. operating temp. ± 2 | | | | | | | | | | | | | | | | | | | | | | | |
| 3 | Reference temp. ± 2 | | | | | | | | | | | | | | | | | | | | | | | |
| 4 | Max. operating temp. ± 2 | | | | | | | | | | | | | | | | | | | | | | | |
| 8 | Robustness of Terminations | No sign of termination coming off, breakage of ceramic, or other abnormal signs. | <p>Reflow solder the capacitors on a P.C.Board shown in Appendix 2.</p> <p>Apply a pushing force gradually at the center of a specimen in a horizontal direction of P.C.board.</p> <p>Pushing force : 5N (2N is applied for C1005 type.) Holding time : 10±1s</p>  | | | | | | | | | | | | | | | | | | | | | |
| 9 | Bending | No mechanical damage. | <p>Reflow solder the capacitors on a P.C.Board shown in Appendix1 and bend it for 1mm.</p>  <p>(Unit : mm)</p> | | | | | | | | | | | | | | | | | | | | | |

(continued)

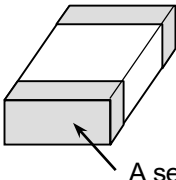
| No. | Item | Performance | Test or inspection method | | | | | | | | | | | | | | | | | | | | | |
|-----------------------|--|---|---|---|-------------|--|--|---------|--------------------------------------|---------|-----------|--|---------|--------------------------------------|---------|------------|------------------------|---------------|------------------------|-----------------------|------------------------|---------------|--|--|
| 10 | Solderability | <p>New solder to cover over 75% of termination. 25% may have pin holes or rough spots but not concentrated in one spot. Ceramic surface of A sections shall not be exposed due to melting or shifting of termination material.</p>  <p>A section</p> | <p>Solder : Sn-3.0Ag-0.5Cu</p> <p>Flux : Isopropyl alcohol (JIS K 8839) Rosin (JIS K 5902) 25% solid solution.</p> <p>Solder temp. : 245±5°C (Sn-3.0Ag-0.5Cu)</p> <p>Dwell time : 3±0.3s.(Sn-3.0Ag-0.5Cu)</p> <p>Solder position : Until both terminations are completely soaked.</p> | | | | | | | | | | | | | | | | | | | | | |
| 11 | Resistance to solder heat | <table border="1"> <tr> <td>External appearance</td> <td>No cracks are allowed and terminations shall be covered at least 60% with new solder.</td> </tr> <tr> <td>Capacitance</td> <td> <table border="1"> <thead> <tr> <th colspan="2">Characteristics</th> <th>Change from the value before test</th> </tr> </thead> <tbody> <tr> <td>Class 1</td> <td>C0G CH</td> <td>Capacitance drift within ±2.5% or ±0.25pF, whichever larger.</td> </tr> <tr> <td>Class 2</td> <td>X5R X6S X7R X7S X7T B</td> <td>± 7.5 %</td> </tr> </tbody> </table> </td> </tr> <tr> <td>Q (Class1)</td> <td>Meet the initial spec.</td> </tr> <tr> <td>D.F. (Class2)</td> <td>Meet the initial spec.</td> </tr> <tr> <td>Insulation Resistance</td> <td>Meet the initial spec.</td> </tr> <tr> <td>Voltage proof</td> <td>No insulation breakdown or other damage.</td> </tr> </table> | External appearance | No cracks are allowed and terminations shall be covered at least 60% with new solder. | Capacitance | <table border="1"> <thead> <tr> <th colspan="2">Characteristics</th> <th>Change from the value before test</th> </tr> </thead> <tbody> <tr> <td>Class 1</td> <td>C0G CH</td> <td>Capacitance drift within ±2.5% or ±0.25pF, whichever larger.</td> </tr> <tr> <td>Class 2</td> <td>X5R X6S X7R X7S X7T B</td> <td>± 7.5 %</td> </tr> </tbody> </table> | Characteristics | | Change from the value before test | Class 1 | C0G CH | Capacitance drift within ±2.5% or ±0.25pF, whichever larger. | Class 2 | X5R X6S X7R X7S X7T B | ± 7.5 % | Q (Class1) | Meet the initial spec. | D.F. (Class2) | Meet the initial spec. | Insulation Resistance | Meet the initial spec. | Voltage proof | No insulation breakdown or other damage. | <p>Solder : Sn-3.0Ag-0.5Cu</p> <p>Flux : Isopropyl alcohol (JIS K 8839) Rosin (JIS K 5902) 25% solid solution.</p> <p>Solder temp. : 260±5°C</p> <p>Dwell time : 10±1s.</p> <p>Solder position : Until both terminations are completely soaked.</p> <p>Pre-heating : Temp. — 110~140°C Time — 30~60s.</p> <p>Leave the capacitors in ambient condition for Class 1 : 6~24h Class 2 : 24±2h before measurement.</p> |
| External appearance | No cracks are allowed and terminations shall be covered at least 60% with new solder. | | | | | | | | | | | | | | | | | | | | | | | |
| Capacitance | <table border="1"> <thead> <tr> <th colspan="2">Characteristics</th> <th>Change from the value before test</th> </tr> </thead> <tbody> <tr> <td>Class 1</td> <td>C0G CH</td> <td>Capacitance drift within ±2.5% or ±0.25pF, whichever larger.</td> </tr> <tr> <td>Class 2</td> <td>X5R X6S X7R X7S X7T B</td> <td>± 7.5 %</td> </tr> </tbody> </table> | Characteristics | | Change from the value before test | Class 1 | C0G CH | Capacitance drift within ±2.5% or ±0.25pF, whichever larger. | Class 2 | X5R X6S X7R X7S X7T B | ± 7.5 % | | | | | | | | | | | | | | |
| Characteristics | | Change from the value before test | | | | | | | | | | | | | | | | | | | | | | |
| Class 1 | C0G CH | Capacitance drift within ±2.5% or ±0.25pF, whichever larger. | | | | | | | | | | | | | | | | | | | | | | |
| Class 2 | X5R X6S X7R X7S X7T B | ± 7.5 % | | | | | | | | | | | | | | | | | | | | | | |
| Q (Class1) | Meet the initial spec. | | | | | | | | | | | | | | | | | | | | | | | |
| D.F. (Class2) | Meet the initial spec. | | | | | | | | | | | | | | | | | | | | | | | |
| Insulation Resistance | Meet the initial spec. | | | | | | | | | | | | | | | | | | | | | | | |
| Voltage proof | No insulation breakdown or other damage. | | | | | | | | | | | | | | | | | | | | | | | |

(continued)

| No. | Item | | Performance | Test or inspection method | | | | | | | | | | | | | | | |
|-----------------------|--|---------------------|---|--|--------------------------------------|-------------------------------------|-------------|---|------------------------|--------|---|---------------|-------|---|------------------------|--------|---|---------------|-------|
| 12 | Vibration | External appearance | No mechanical damage. | Frequency : 10~55~10Hz Reciprocating sweep time : 1 min. Amplitude : 1.5mm Repeat this for 2h each in 3 perpendicular directions(Total 6h). Reflow solder the capacitors on a P.C.Board shown in Appendix 2 before testing. | | | | | | | | | | | | | | | |
| | | Capacitance | Characteristics | | Change from the value before test | | | | | | | | | | | | | | |
| | | | Class1 | | C0G CH | ±2.5% or ±0.25pF, whichever larger. | | | | | | | | | | | | | |
| | | | Class2 | | X5R X6S X7R X7S X7T B | ± 7.5 % | | | | | | | | | | | | | |
| | | Q (Class1) | Meet the initial spec. | | | | | | | | | | | | | | | | |
| D.F. (Class2) | Meet the initial spec. | | | | | | | | | | | | | | | | | | |
| 13 | Temperature cycle | External appearance | No mechanical damage. | Expose the capacitors in the condition step1 through step 4 listed in the following table. Temp. cycle : 5 cycles <table border="1" data-bbox="986 1055 1479 1391"> <thead> <tr> <th>Step</th> <th>Temperature(°C)</th> <th>Time (min.)</th> </tr> </thead> <tbody> <tr> <td>1</td> <td>Min. operating temp.±3</td> <td>30 ± 3</td> </tr> <tr> <td>2</td> <td>Ambient Temp.</td> <td>2 ~ 5</td> </tr> <tr> <td>3</td> <td>Max. operating temp.±2</td> <td>30 ± 2</td> </tr> <tr> <td>4</td> <td>Ambient Temp.</td> <td>2 ~ 5</td> </tr> </tbody> </table> | Step | Temperature(°C) | Time (min.) | 1 | Min. operating temp.±3 | 30 ± 3 | 2 | Ambient Temp. | 2 ~ 5 | 3 | Max. operating temp.±2 | 30 ± 2 | 4 | Ambient Temp. | 2 ~ 5 |
| | | Step | Temperature(°C) | | Time (min.) | | | | | | | | | | | | | | |
| | | 1 | Min. operating temp.±3 | | 30 ± 3 | | | | | | | | | | | | | | |
| | | 2 | Ambient Temp. | | 2 ~ 5 | | | | | | | | | | | | | | |
| | | 3 | Max. operating temp.±2 | | 30 ± 2 | | | | | | | | | | | | | | |
| | | 4 | Ambient Temp. | | 2 ~ 5 | | | | | | | | | | | | | | |
| | | Capacitance | Characteristics | | Change from the value before test | | | | | | | | | | | | | | |
| Class1 | C0G CH | | Please contact with our sales representative | | | | | | | | | | | | | | | | |
| Class2 | X5R X6S X7R X7S X7T B | | | | | | | | | | | | | | | | | | |
| Q (Class1) | Meet the initial spec. | | | | | | | | | | | | | | | | | | |
| D.F. (Class2) | Meet the initial spec. | | As for Min./Max. operating temp., please refer to "3. OPERATING TEMPERATURE RANGE" Leave the capacitors in ambient condition for Class 1 : 6~24h Class 2 : 24±2h before measurement. | | | | | | | | | | | | | | | | |
| Insulation Resistance | Meet the initial spec. | | | | | | | | | | | | | | | | | | |
| Voltage proof | No insulation breakdown or other damage. | | | Reflow solder the capacitors on a P.C.Board shown in Appendix2 before testing. | | | | | | | | | | | | | | | |

(continued)

| No. | Item | | Performance | Test or inspection method | | | | | | | | | | | | | |
|--------------------------|--|---------------------|---|---|-----------------------------------|---|-----------------------------------|------------|-----------------------|--------|-----|---|-----|-----|-----|-----|---|
| 14 | Moisture Resistance (Steady State) | External appearance | No mechanical damage. | Test temp. : $40\pm 2^{\circ}\text{C}$ Test humidity : 90~95%RH Test time : 500 +24,0h Leave the capacitors in ambient condition for Class 1 : 6~24h Class 2 : 24 ± 2 h before measurement. Reflow solder the capacitors on a P.C.Board shown in Appendix2 before testing. | | | | | | | | | | | | | |
| | | Capacitance | <table border="1"> <thead> <tr> <th colspan="2">Characteristics</th> <th rowspan="2">Change from the value before test</th> </tr> </thead> <tbody> <tr> <td>Class1</td> <td>C0G CH</td> </tr> <tr> <td rowspan="4">Class2</td> <td>X5R</td> <td rowspan="4">Please contact with our sales representative.</td> </tr> <tr> <td>X6S</td> </tr> <tr> <td>X7R</td> </tr> <tr> <td>X7S</td> </tr> <tr> <td>X7T</td> <td>B</td> </tr> </tbody> </table> | | Characteristics | | Change from the value before test | Class1 | C0G CH | Class2 | X5R | Please contact with our sales representative. | X6S | X7R | X7S | X7T | B |
| | | | Characteristics | | Change from the value before test | | | | | | | | | | | | |
| | | | Class1 | | | C0G CH | | | | | | | | | | | |
| | | | Class2 | | X5R | Please contact with our sales representative. | | | | | | | | | | | |
| X6S | | | | | | | | | | | | | | | | | |
| X7R | | | | | | | | | | | | | | | | | |
| X7S | | | | | | | | | | | | | | | | | |
| X7T | B | | | | | | | | | | | | | | | | |
| Q (Class1) | <table border="1"> <thead> <tr> <th>Capacitance</th> <th>Q</th> </tr> </thead> <tbody> <tr> <td>30pF and over</td> <td>350 min.</td> </tr> <tr> <td>10pF and over under 30pF</td> <td>$275+5/2\times C$ min.</td> </tr> <tr> <td>Under 10pF</td> <td>$200+10\times C$ min.</td> </tr> </tbody> </table> C : Rated capacitance (pF) | Capacitance | Q | 30pF and over | 350 min. | 10pF and over under 30pF | $275+5/2\times C$ min. | Under 10pF | $200+10\times C$ min. | | | | | | | | |
| | Capacitance | Q | | | | | | | | | | | | | | | |
| | 30pF and over | 350 min. | | | | | | | | | | | | | | | |
| 10pF and over under 30pF | $275+5/2\times C$ min. | | | | | | | | | | | | | | | | |
| Under 10pF | $200+10\times C$ min. | | | | | | | | | | | | | | | | |
| D.F. (Class2) | 200% of initial spec. max. | | | | | | | | | | | | | | | | |
| Insulation Resistance | Please contact with our sales representative. | | | | | | | | | | | | | | | | |

(continued)

| No. | Item | | Performance | Test or inspection method | | | | | | | | |
|-----------------------|---|---------------------|--|---|-----------------------------------|---|-----------------------------------|------------|-----------------|---|--------|--------------------------------------|
| 15 | Moisture Resistance | External appearance | No mechanical damage. | Test temp. : 40±2°C Test humidity : 90~95%RH Applied voltage : Rated voltage Test time : 500 +24,0h Charge/discharge current : 50mA or lower Leave the capacitors in ambient condition for Class 1 : 6~24h Class 2 : 24±2h before measurement. Reflow solder the capacitors on a P.C.Board shown in Appendix2 before testing. | | | | | | | | |
| | | Capacitance | <table border="1"> <thead> <tr> <th colspan="2">Characteristics</th> <th>Change from the value before test</th> </tr> </thead> <tbody> <tr> <td>Class1</td> <td>C0G CH</td> <td rowspan="3">Please contact with our sales representative.</td> </tr> <tr> <td rowspan="2">Class2</td> <td>X5R X6S X7R X7S X7T B</td> </tr> </tbody> </table> | | Characteristics | | Change from the value before test | Class1 | C0G CH | Please contact with our sales representative. | Class2 | X5R X6S X7R X7S X7T B |
| | | | Characteristics | | Change from the value before test | | | | | | | |
| | | | Class1 | | C0G CH | Please contact with our sales representative. | | | | | | |
| | | Class2 | X5R X6S X7R X7S X7T B | | | | | | | | | |
| Q (Class1) | <table border="1"> <thead> <tr> <th>Capacitance</th> <th>Q</th> </tr> </thead> <tbody> <tr> <td>30pF and over</td> <td>200 min.</td> </tr> <tr> <td>Under 30pF</td> <td>100+10/3xC min.</td> </tr> </tbody> </table> C : Rated capacitance (pF) | | Capacitance | Q | 30pF and over | | 200 min. | Under 30pF | 100+10/3xC min. | | | |
| Capacitance | Q | | | | | | | | | | | |
| 30pF and over | 200 min. | | | | | | | | | | | |
| Under 30pF | 100+10/3xC min. | | | | | | | | | | | |
| D.F. (Class2) | 200% of initial spec. max. | | | | | | | | | | | |
| Insulation Resistance | Please contact with our sales representative. | | | | | | | | | | | |

(continued)

| No. | Item | Performance | Test or inspection method | | | | | | | | |
|--------------------------|--|--|---|-----------------------------------|----------|-----------------------------------|-------------------------|------------|------------------------|--------------------------------------|---|
| 16 | Life | | | | | | | | | | |
| | External appearance | No mechanical damage. | Test temp. : Maximum operating temperature $\pm 2^{\circ}\text{C}$ Applied voltage : Please contact with our sales representative. Test time : 1,000 +48,0h Charge/discharge current : 50mA or lower Leave the capacitors in ambient condition for Class 1 : 6~24h Class 2 : 24 \pm 2h before measurement. Reflow solder the capacitors on a P.C.Board shown in Appendix2 before testing. Initial value setting (only for class 2) Voltage conditioning «After voltage treat the capacitors under testing temperature and voltage for 1 hour,» leave the capacitors in ambient condition for 24 \pm 2h before measurement. Use this measurement for initial value. | | | | | | | | |
| | Capacitance | <table border="1"> <thead> <tr> <th colspan="2">Characteristics</th> <th rowspan="2">Change from the value before test</th> </tr> </thead> <tbody> <tr> <td>Class1</td> <td>C0G CH</td> </tr> <tr> <td>Class2</td> <td>X5R X6S X7R X7S X7T B</td> <td>Please contact with our sales representative.</td> </tr> </tbody> </table> | | Characteristics | | Change from the value before test | Class1 | C0G CH | Class2 | X5R X6S X7R X7S X7T B | Please contact with our sales representative. |
| | Characteristics | | | Change from the value before test | | | | | | | |
| | Class1 | C0G CH | | | | | | | | | |
| Class2 | X5R X6S X7R X7S X7T B | Please contact with our sales representative. | | | | | | | | | |
| Q (Class1) | <table border="1"> <thead> <tr> <th>Capacitance</th> <th>Q</th> </tr> </thead> <tbody> <tr> <td>30pF and over</td> <td>350 min.</td> </tr> <tr> <td>10pF and over under 30pF</td> <td>275+5/2\timesC min.</td> </tr> <tr> <td>Under 10pF</td> <td>200+10\timesC min.</td> </tr> </tbody> </table> C : Rated capacitance (pF) | Capacitance | Q | 30pF and over | 350 min. | 10pF and over under 30pF | 275+5/2 \times C min. | Under 10pF | 200+10 \times C min. | | |
| Capacitance | Q | | | | | | | | | | |
| 30pF and over | 350 min. | | | | | | | | | | |
| 10pF and over under 30pF | 275+5/2 \times C min. | | | | | | | | | | |
| Under 10pF | 200+10 \times C min. | | | | | | | | | | |
| D.F. (Class2) | 200% of initial spec. max. | | | | | | | | | | |
| Insulation Resistance | Please contact with our sales representative. | | | | | | | | | | |

*As for the initial measurement of capacitors (Class2) on number 7,11,12,13 and 14, leave capacitors at 150 0,-10°C for 1 hour and measure the value after leaving capacitors for 24 \pm 2h in ambient condition.

Appendix1 P.C.Board for bending test

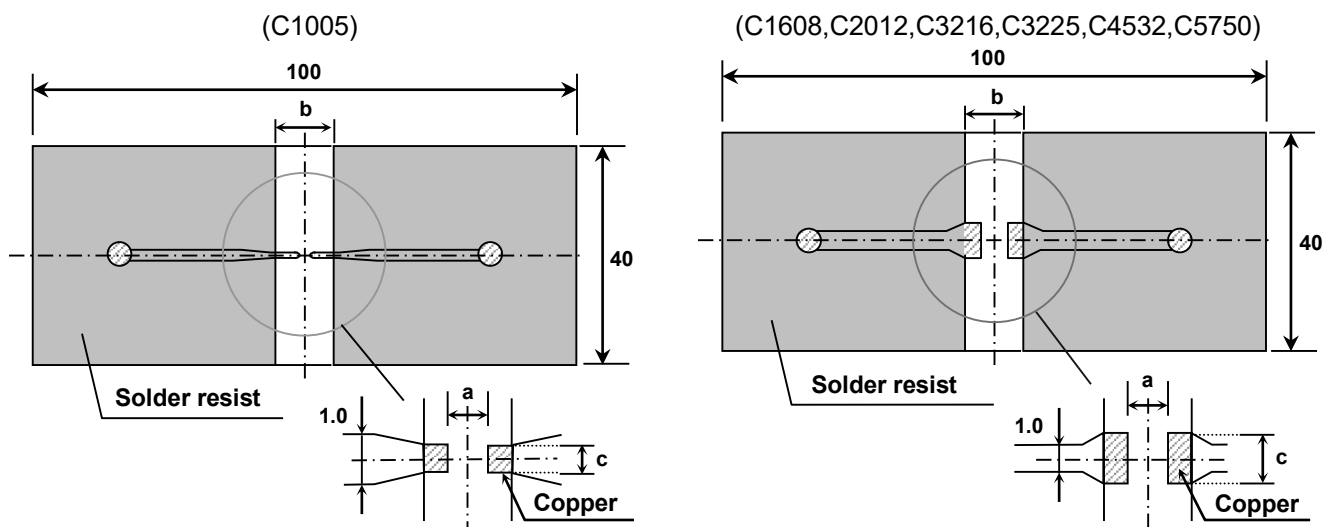

Appendix2 P.C. Board for reliability test

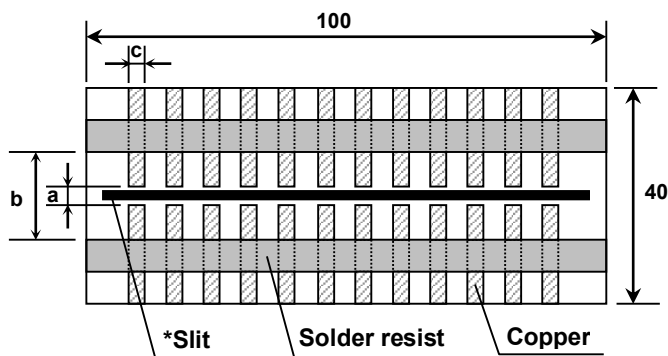

* It is recommended to provide a slit on P.C.Board for C3225,C4532 and C5750.

(Unit : mm)

| Case size | Symbol | a | b | c |
|-----------|----------|-----|-----|------|
| C1005 | [CC0402] | 0.4 | 1.5 | 0.5 |
| C1608 | [CC0603] | 1.0 | 3.0 | 1.2 |
| C2012 | [CC0805] | 1.2 | 4.0 | 1.65 |
| C3216 | [CC1206] | 2.2 | 5.0 | 2.0 |
| C3225 | [CC1210] | 2.2 | 5.0 | 2.9 |
| C4532 | [CC1812] | 3.5 | 7.0 | 3.7 |
| C5750 | [CC2220] | 4.5 | 8.0 | 5.6 |

1. Material : Glass Epoxy(As per JIS C6484 GE4)

2. Thickness : Appendix 1 — 0.8mm (C1005)
 — 1.6mm (C1608,C2012,C3216,C3225,C4532,C5750)
 : Appendix 2 — 1.6mm

Copper(Thickness:0.035mm)
 Solder resist

8. INSIDE STRUCTURE AND MATERIAL

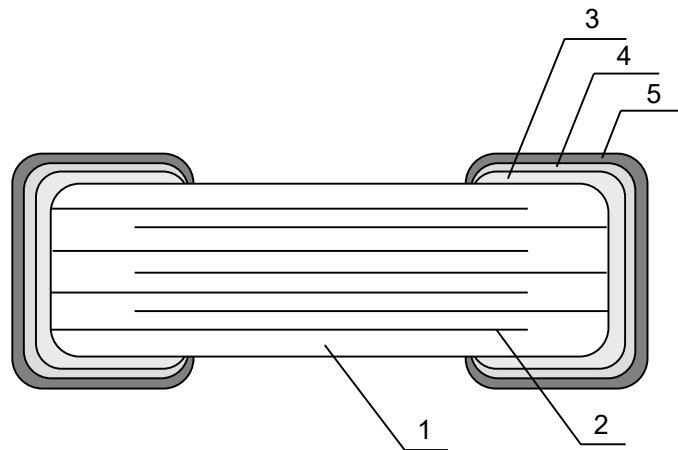

| No. | NAME | MATERIAL | |
|-----|-------------|--------------------|--------------------|
| | | Class1 | Class2 |
| 1 | Dielectric | CaZrO ₃ | BaTiO ₃ |
| 2 | Electrode | Nickel (Ni) | |
| 3 | Termination | Copper (Cu) | |
| 4 | | Nickel (Ni) | |
| 5 | | Tin (Sn) | |

9. PACKAGING

Packaging shall be done to protect the components from the damage during transportation and storing, and a label which has the following information shall be attached.

9.1 Each plastic bag for bulk packaging contains 1000pcs. And the minimum quantity for Bulk packaging is 1000pcs.

9.2 Tape packaging is as per 13. TAPE PACKAGING SPECIFICATION.

*C1005[CC0402] type is applicable to tape packaging only.

- 1) Inspection No.*
- 2) TDK P/N
- 3) Customer's P/N
- 4) Quantity

*Composition of Inspection No.

Example E 0 A - 23 - 001
 (a) (b) (c) (d) (e)

- (a) Line code
- (b) Last digit of the year
- (c) Month and A for January and B for February and so on. (Skip I)
- (d) Inspection Date of the month.
- (e) Serial No. of the day

*Composition of new Inspection No.

(Implemented on and after May 1, 2019 in sequence)

Example

| | | | | | | | | | |
|---|---|---|---|---|---|---|---|---|---|
| I | F | 0 | E | 2 | 3 | A | 0 | 0 | 1 |
|---|---|---|---|---|---|---|---|---|---|

 (a) (b) (c) (d) (e) (f) (g)

- (a) Prefix
- (b) Line code
- (c) Last digit of the year
- (d) Month and A for January and B for February and so on. (Skip I)
- (e) Inspection Date of the month.
- (f) Serial No. of the day(00 ~ ZZ)
- (g) Suffix(00 ~ ZZ)

* It was shifted to the new inspection No. on and after May 2019, but the implementation timing may be different depending on shipment bases. Until the shift is completed, either current or new composition of inspection No. will be applied.

10. RECOMMENDATION

As for C3225[CC1210] and larger, It is recommended to provide a slit (about 1mm width) in the board under the components to improve washing Flux. And please make sure to dry detergent up completely before.

11. SOLDERING CONDITION

As for C1005[CC0402], C3225[CC1210] and larger, reflow soldering only.
 For other case sizes than the above, reflow soldering is recommended.

12. CAUTION

| No. | Process | Condition |
|-----|---|---|
| 1 | Operating Condition (Storage, Use, Transportation) | <p>1-1. Storage, Use The capacitors must be stored in an ambient temperature of 5 to 40°C with a relative humidity of 20 to 70%RH. JIS C 60721-3-1 Class 1K2 should be followed for the other climatic conditions.</p> <ol style="list-style-type: none"> 1) High temperature and humidity environment may affect a capacitor's solder ability because it accelerates terminal oxidization. They also deteriorate performance of taping and packaging. Therefore, SMD capacitors shall be used within 6 months. For capacitors with terminal electrodes consisting of silver or silver-palladium which tend to become oxidized or sulfurized, use as soon as possible, such as within one month after opening the bag. 2) When capacitors are stored for a longer time period than 6 months, confirm the solderability of the capacitors prior to use. During storage, keep the minimum packaging unit in its original packaging without opening it. Do not deviate from the above temperature and humidity conditions even for a short term. 3) Corrosive gasses in the air or atmosphere may result in deterioration of the reliability, such as poor solderability of the terminal electrodes. Do not store capacitors where they will be exposed to corrosive gas (e.g., hydrogen sulfide, sulfur dioxide, chlorine ammonia etc.) 4) Solderability and electrical performance may deteriorate due to photochemical change in the terminal electrode if stored in direct sunlight, or due to condensation from rapid changes in humidity. The capacitors especially which use resin material must be operated and stored in an environment free of dew condensation, as moisture absorption due to condensation may affect the performance. 5) Refer to JIS C 60721-3-1, class 1K2 for other climate conditions. <p>1-2. Handling in transportation In case of the transportation of the capacitors, the performance of the capacitors may be deteriorated depending on the transportation condition. (Refer to JEITA RCR-2335C 9.2 Handling in transportation)</p> |
| 2 | Circuit design  Caution | <p>2-1. Operating temperature</p> <ol style="list-style-type: none"> 1) Upper category temperature (maximum operating temperature) is specified. It is necessary to select a capacitor whose rated temperature is higher than the operating temperature. Also, it is necessary to consider the temperature distribution in the equipment and seasonal temperature variation. 2) Do not use capacitors above the maximum allowable operating temperature. Surface temperature including self heating should be below maximum operating temperature. (Due to dielectric loss, capacitors will heat itself when AC is applied. Especially at high frequencies around its SRF, the heat might be so extreme that it may damage itself or the product mounted on. Please design the circuit so that the maximum temperature of the capacitors including the self heating to be below the maximum allowable operating temperature. Temperature rise at capacitor surface shall be below 20°C) 3) The electrical characteristics of the capacitors will vary depending on the temperature. The capacitors should be selected and designed in taking the temperature into consideration. <p>2-2. When overvoltage is applied Applying overvoltage to a capacitor may cause dielectric breakdown and result in a short circuit. The duration until dielectric breakdown depends on the applied voltage and the ambient temperature.</p> |

| No. | Process | Condition | | | | | | | | | | | | | | |
|--|---|--|---|----------------|-------------------|----------------|--|---|--|---|---------|-----------------------|-----------------------|--|--|---|
| 2 | Circuit design  Caution | <p>2-3. Operating voltage</p> <p>1) Operating voltage across the terminals should be below the rated voltage. When AC and DC are super imposed, V_{0-P} must be below the rated voltage. — (1) and (2) AC or pulse with overshooting, V_{P-P} must be below the rated voltage. — (3), (4) and (5) When the voltage is started to apply to the circuit or it is stopped applying, the irregular voltage may be generated for a transit period because of resonance or switching. Be sure to use the capacitors within rated voltage containing these Irregular voltage.</p> <table border="1" data-bbox="464 524 1449 1111"> <thead> <tr> <th data-bbox="464 524 662 566">Voltage</th> <th data-bbox="662 524 922 566">(1) DC voltage</th> <th data-bbox="922 524 1182 566">(2) DC+AC voltage</th> <th data-bbox="1182 524 1449 566">(3) AC voltage</th> </tr> </thead> <tbody> <tr> <td data-bbox="464 566 662 797">Positional Measurement (Rated voltage)</td> <td data-bbox="662 566 922 797">  </td> <td data-bbox="922 566 1182 797">  </td> <td data-bbox="1182 566 1449 797">  </td> </tr> <tr> <th data-bbox="464 824 662 866">Voltage</th> <th data-bbox="662 824 922 866">(4) Pulse voltage (A)</th> <th data-bbox="922 824 1182 866">(5) Pulse voltage (B)</th> </tr> <tr> <td data-bbox="464 866 662 1111">Positional Measurement (Rated voltage)</td> <td data-bbox="662 866 922 1111">  </td> <td data-bbox="922 866 1182 1111">  </td> </tr> </tbody> </table> <p>2) Even below the rated voltage, if repetitive high frequency AC or pulse is applied, the reliability of the capacitors may be reduced.</p> <p>3) The effective capacitance will vary depending on applied DC and AC voltages. The capacitors should be selected and designed in taking the voltages into consideration.</p> <p>4) Abnormal voltage (surge voltage, static electricity, pulse voltage, etc.) shall not exceed the rated voltage.</p> <p>5) When capacitors are used in a series connection, it is necessary to add a balancing circuit such as voltage dividing resistors in order to avoid an imbalance in the voltage applied to each capacitor.</p> <p>2-4. Frequency When the capacitors (Class 2) are used in AC and/or pulse voltages, the capacitors may vibrate themselves and generate audible sound.</p> | Voltage | (1) DC voltage | (2) DC+AC voltage | (3) AC voltage | Positional Measurement (Rated voltage) |  |  |  | Voltage | (4) Pulse voltage (A) | (5) Pulse voltage (B) | Positional Measurement (Rated voltage) |  |  |
| Voltage | (1) DC voltage | (2) DC+AC voltage | (3) AC voltage | | | | | | | | | | | | | |
| Positional Measurement (Rated voltage) |  |  |  | | | | | | | | | | | | | |
| Voltage | (4) Pulse voltage (A) | (5) Pulse voltage (B) | | | | | | | | | | | | | | |
| Positional Measurement (Rated voltage) |  |  | | | | | | | | | | | | | | |

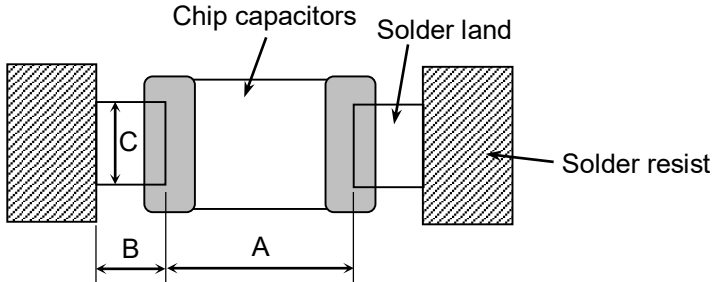
| No. | Process | Condition | | | | | | | | | | | | | | | | | | | | | | | | | | | | | | | | | | | | | | | | | | | | | | | | | | | | |
|-----------|---------------------|--|-------------------|-------------------|-------------------|-------------------|-------------------|---|-----------|-----------|-----------|-----------|---|-------------|-----------|-----------|-----------|---|-----------|-----------|-----------|-----------|-----------|-------------------|-------------------|-------------------|---|-----------|-----------|-----------|---|-----------|-----------|-----------|---|-----------|-----------|-----------|-----------|-------------------|-------------------|-------------------|---|-----------|-----------|-----------|---|-----------|-----------|-----------|---|-----------|-----------|-----------|
| 3 | Designing P.C.board | <p>The amount of solder at the terminations has a direct effect on the reliability of the capacitors.</p> <ol style="list-style-type: none"> 1) The greater the amount of solder, the higher the stress on the chip capacitors, and the more likely that it will break. When designing a P.C.board, determine the shape and size of the solder lands to have proper amount of solder on the terminations. 2) Avoid using common solder land for multiple terminations and provide individual solder land for each terminations. 3) Size and recommended land dimensions. <div style="text-align: center;">  </div> <table border="1" style="width: 100%; margin-top: 10px;"> <caption>Reflow soldering (Unit : mm)</caption> <thead> <tr> <th>Case size</th> <th>C1005 [CC0402]</th> <th>C1608 [CC0603]</th> <th>C2012 [CC0805]</th> <th>C3216 [CC1206]</th> </tr> </thead> <tbody> <tr> <td>A</td> <td>0.3 ~ 0.5</td> <td>0.6 ~ 0.8</td> <td>0.9 ~ 1.2</td> <td>2.0 ~ 2.4</td> </tr> <tr> <td>B</td> <td>0.35 ~ 0.45</td> <td>0.6 ~ 0.8</td> <td>0.7 ~ 0.9</td> <td>1.0 ~ 1.2</td> </tr> <tr> <td>C</td> <td>0.4 ~ 0.6</td> <td>0.6 ~ 0.8</td> <td>0.9 ~ 1.2</td> <td>1.1 ~ 1.6</td> </tr> </tbody> </table> <table border="1" style="width: 100%; margin-top: 10px;"> <thead> <tr> <th>Case size</th> <th>C3225 [CC1210]</th> <th>C4532 [CC1812]</th> <th>C5750 [CC2220]</th> </tr> </thead> <tbody> <tr> <td>A</td> <td>2.0 ~ 2.4</td> <td>3.1 ~ 3.7</td> <td>4.1 ~ 4.8</td> </tr> <tr> <td>B</td> <td>1.0 ~ 1.2</td> <td>1.2 ~ 1.4</td> <td>1.2 ~ 1.4</td> </tr> <tr> <td>C</td> <td>1.9 ~ 2.5</td> <td>2.4 ~ 3.2</td> <td>4.0 ~ 5.0</td> </tr> </tbody> </table> <table border="1" style="width: 100%; margin-top: 10px;"> <caption>Flow soldering (Unrecommend) (Unit : mm)</caption> <thead> <tr> <th>Case size</th> <th>C1608 [CC0603]</th> <th>C2012 [CC0805]</th> <th>C3216 [CC1206]</th> </tr> </thead> <tbody> <tr> <td>A</td> <td>0.7 ~ 1.0</td> <td>1.0 ~ 1.3</td> <td>2.1 ~ 2.5</td> </tr> <tr> <td>B</td> <td>0.8 ~ 1.0</td> <td>1.0 ~ 1.2</td> <td>1.1 ~ 1.3</td> </tr> <tr> <td>C</td> <td>0.6 ~ 0.8</td> <td>0.8 ~ 1.1</td> <td>1.0 ~ 1.3</td> </tr> </tbody> </table> | Case size | C1005 [CC0402] | C1608 [CC0603] | C2012 [CC0805] | C3216 [CC1206] | A | 0.3 ~ 0.5 | 0.6 ~ 0.8 | 0.9 ~ 1.2 | 2.0 ~ 2.4 | B | 0.35 ~ 0.45 | 0.6 ~ 0.8 | 0.7 ~ 0.9 | 1.0 ~ 1.2 | C | 0.4 ~ 0.6 | 0.6 ~ 0.8 | 0.9 ~ 1.2 | 1.1 ~ 1.6 | Case size | C3225 [CC1210] | C4532 [CC1812] | C5750 [CC2220] | A | 2.0 ~ 2.4 | 3.1 ~ 3.7 | 4.1 ~ 4.8 | B | 1.0 ~ 1.2 | 1.2 ~ 1.4 | 1.2 ~ 1.4 | C | 1.9 ~ 2.5 | 2.4 ~ 3.2 | 4.0 ~ 5.0 | Case size | C1608 [CC0603] | C2012 [CC0805] | C3216 [CC1206] | A | 0.7 ~ 1.0 | 1.0 ~ 1.3 | 2.1 ~ 2.5 | B | 0.8 ~ 1.0 | 1.0 ~ 1.2 | 1.1 ~ 1.3 | C | 0.6 ~ 0.8 | 0.8 ~ 1.1 | 1.0 ~ 1.3 |
| Case size | C1005 [CC0402] | C1608 [CC0603] | C2012 [CC0805] | C3216 [CC1206] | | | | | | | | | | | | | | | | | | | | | | | | | | | | | | | | | | | | | | | | | | | | | | | | | | |
| A | 0.3 ~ 0.5 | 0.6 ~ 0.8 | 0.9 ~ 1.2 | 2.0 ~ 2.4 | | | | | | | | | | | | | | | | | | | | | | | | | | | | | | | | | | | | | | | | | | | | | | | | | | |
| B | 0.35 ~ 0.45 | 0.6 ~ 0.8 | 0.7 ~ 0.9 | 1.0 ~ 1.2 | | | | | | | | | | | | | | | | | | | | | | | | | | | | | | | | | | | | | | | | | | | | | | | | | | |
| C | 0.4 ~ 0.6 | 0.6 ~ 0.8 | 0.9 ~ 1.2 | 1.1 ~ 1.6 | | | | | | | | | | | | | | | | | | | | | | | | | | | | | | | | | | | | | | | | | | | | | | | | | | |
| Case size | C3225 [CC1210] | C4532 [CC1812] | C5750 [CC2220] | | | | | | | | | | | | | | | | | | | | | | | | | | | | | | | | | | | | | | | | | | | | | | | | | | | |
| A | 2.0 ~ 2.4 | 3.1 ~ 3.7 | 4.1 ~ 4.8 | | | | | | | | | | | | | | | | | | | | | | | | | | | | | | | | | | | | | | | | | | | | | | | | | | | |
| B | 1.0 ~ 1.2 | 1.2 ~ 1.4 | 1.2 ~ 1.4 | | | | | | | | | | | | | | | | | | | | | | | | | | | | | | | | | | | | | | | | | | | | | | | | | | | |
| C | 1.9 ~ 2.5 | 2.4 ~ 3.2 | 4.0 ~ 5.0 | | | | | | | | | | | | | | | | | | | | | | | | | | | | | | | | | | | | | | | | | | | | | | | | | | | |
| Case size | C1608 [CC0603] | C2012 [CC0805] | C3216 [CC1206] | | | | | | | | | | | | | | | | | | | | | | | | | | | | | | | | | | | | | | | | | | | | | | | | | | | |
| A | 0.7 ~ 1.0 | 1.0 ~ 1.3 | 2.1 ~ 2.5 | | | | | | | | | | | | | | | | | | | | | | | | | | | | | | | | | | | | | | | | | | | | | | | | | | | |
| B | 0.8 ~ 1.0 | 1.0 ~ 1.2 | 1.1 ~ 1.3 | | | | | | | | | | | | | | | | | | | | | | | | | | | | | | | | | | | | | | | | | | | | | | | | | | | |
| C | 0.6 ~ 0.8 | 0.8 ~ 1.1 | 1.0 ~ 1.3 | | | | | | | | | | | | | | | | | | | | | | | | | | | | | | | | | | | | | | | | | | | | | | | | | | | |

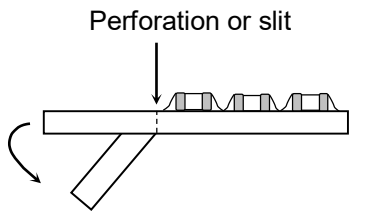
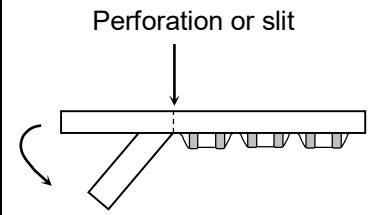
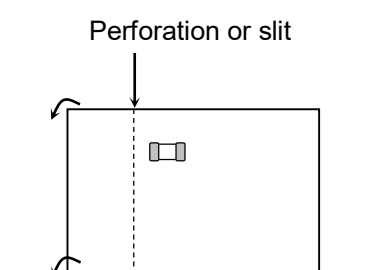
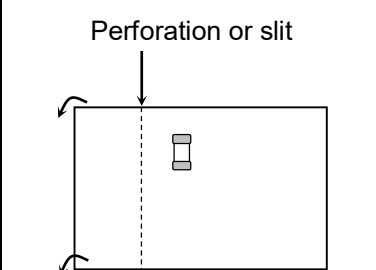
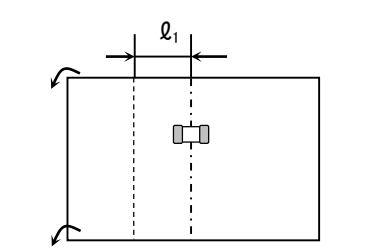
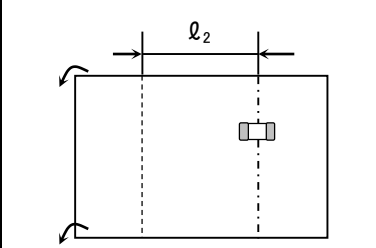
| No. | Process | Condition | | |
|------------------------------|---------------------|--|---|----------------------------------|
| 3 | Designing P.C.board | 4) Recommended chip capacitors layout is as following. | | |
| | | | Disadvantage against bending stress | Advantage against bending stress |
| Mounting face | | <p>Perforation or slit</p>  <p>Break P.C.board with mounted side up.</p> | <p>Perforation or slit</p>  <p>Break P.C.board with mounted side down.</p> | |
| Chip arrangement (Direction) | | <p>Mount perpendicularly to perforation or slit</p> <p>Perforation or slit</p>  | <p>Mount in parallel with perforation or slit</p> <p>Perforation or slit</p>  | |
| Distance from slit | | <p>Closer to slit is higher stress</p>  <p>($l_1 < l_2$)</p> | <p>Away from slit is less stress</p>  <p>($l_1 < l_2$)</p> | |

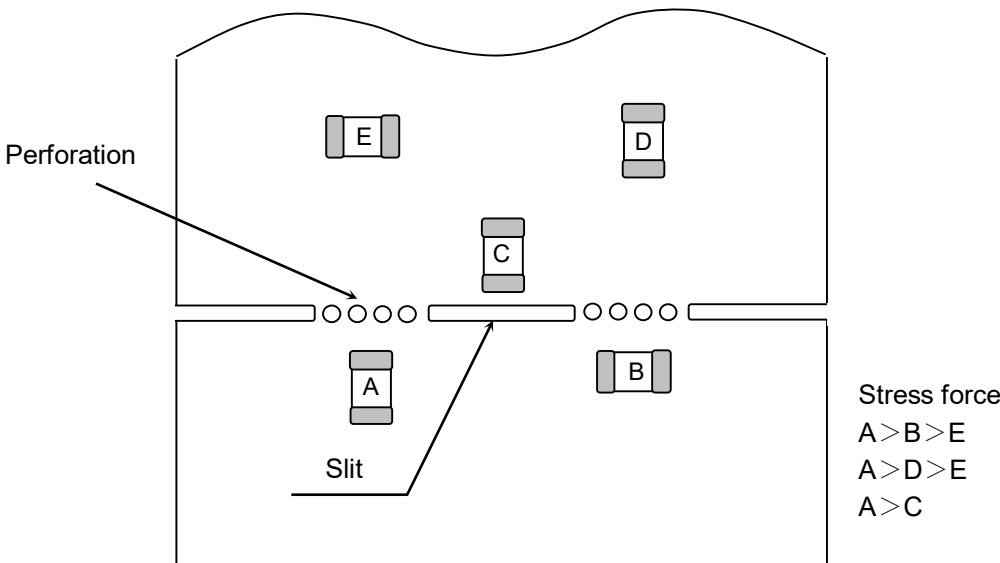
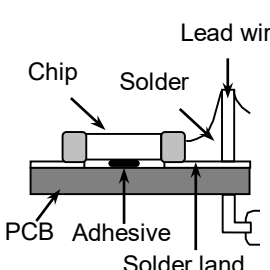
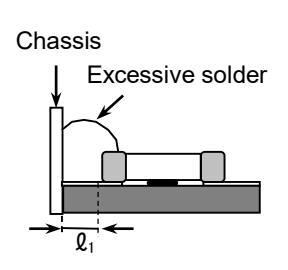
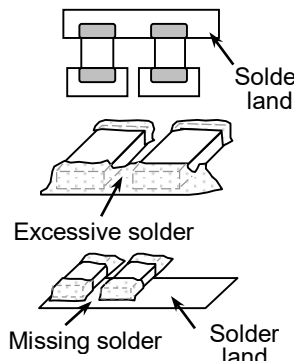
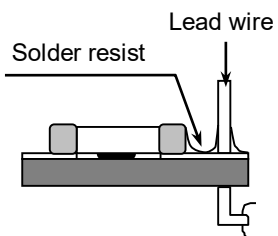
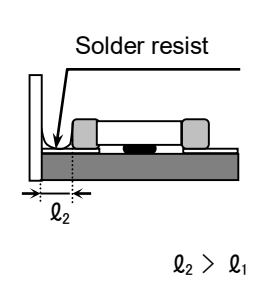
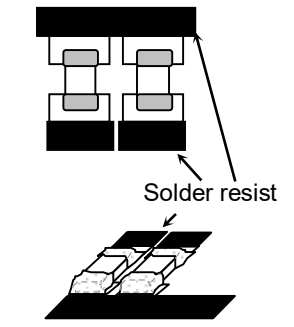
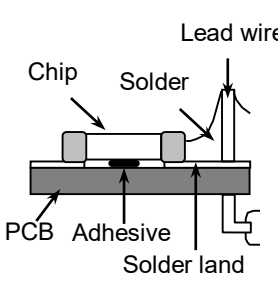
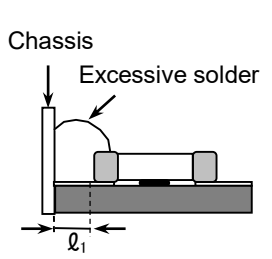
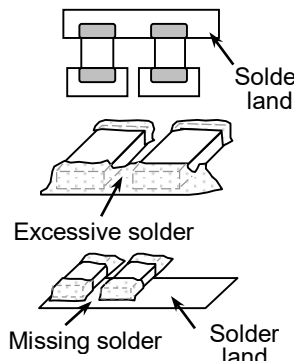
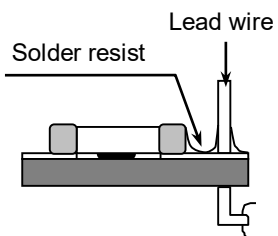
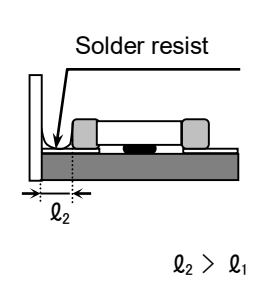
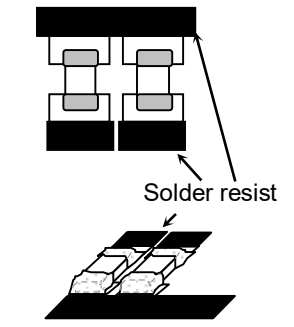
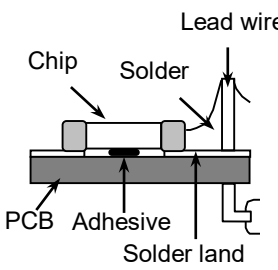
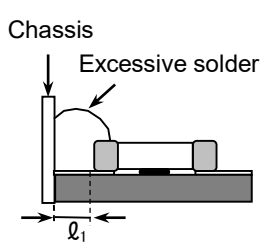
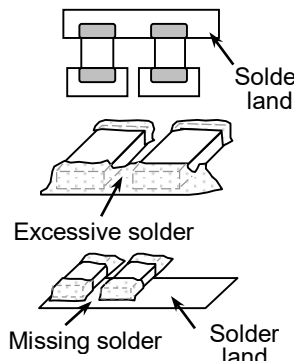
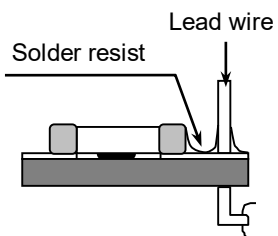
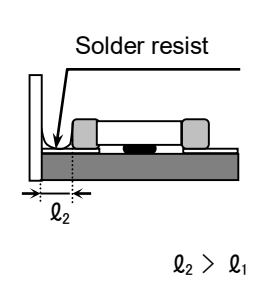
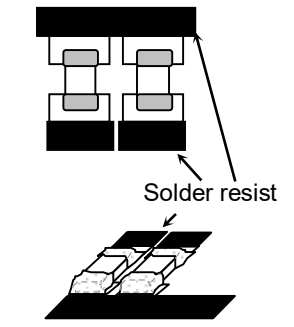
| No. | Process | Condition | | | | | | | | | | | | |
|----------------|---|---|---|---------------------------|------------------------|--|---------------|---|--|---|----------------|---|--|---|
| 3 | Designing P.C.board | <p>5) Mechanical stress varies according to location of chip capacitors on the P.C.board.</p>  <p>When dividing printed wiring boards, the intensities of mechanical stress applied to capacitors are different according to each dividing method in the order of : Push-back < Slit < V-groove < Perforation. Therefore consider not only position of capacitors, but also the way of the dividing the printed wiring boards.</p> <p>6) Layout recommendation</p> <table border="1" data-bbox="367 1097 1468 2016"> <thead> <tr> <th data-bbox="367 1097 531 1209">Example</th> <th data-bbox="531 1097 837 1209">Use of common solder land</th> <th data-bbox="837 1097 1144 1209">Soldering with chassis</th> <th data-bbox="1144 1097 1468 1209">Use of common solder land with other SMD</th> </tr> </thead> <tbody> <tr> <td data-bbox="367 1209 531 1590">Need to avoid</td> <td data-bbox="531 1209 837 1590">  </td> <td data-bbox="837 1209 1144 1590">  </td> <td data-bbox="1144 1209 1468 1590">  </td> </tr> <tr> <td data-bbox="367 1590 531 2016">Recommendation</td> <td data-bbox="531 1590 837 2016">  </td> <td data-bbox="837 1590 1144 2016">  </td> <td data-bbox="1144 1590 1468 2016">  </td> </tr> </tbody> </table> | Example | Use of common solder land | Soldering with chassis | Use of common solder land with other SMD | Need to avoid |  |  |  | Recommendation |  |  |  |
| Example | Use of common solder land | Soldering with chassis | Use of common solder land with other SMD | | | | | | | | | | | |
| Need to avoid |  |  |  | | | | | | | | | | | |
| Recommendation |  |  |  | | | | | | | | | | | |

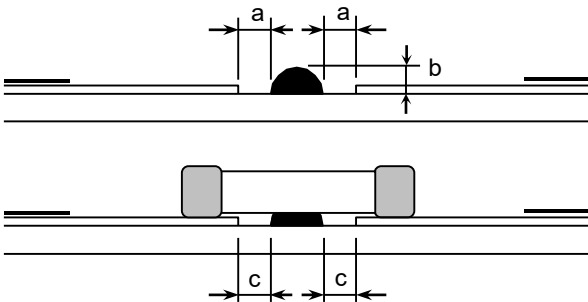
| No. | Process | Condition | | | | | | | | | | | | | | | |
|-----------------------|---|---|--|-----------------|-------------|-----------------------|--|---|-----------------------|---|--|---|------------|---|------------|---|------------------------------|
| 4 | Mounting | <p>4-1. Stress from mounting head</p> <p>If the mounting head is adjusted too low, it may induce excessive stress in the chip capacitors to result in cracking. Please take following precautions.</p> <ol style="list-style-type: none"> 1) Adjust the bottom dead center of the mounting head to reach on the P.C.board surface and not press it. 2) Adjust the mounting head pressure to be 1 to 3N of static weight. 3) To minimize the impact energy from mounting head, it is important to provide support from the bottom side of the P.C.board. See following examples. <table border="1" data-bbox="475 622 1425 1211"> <thead> <tr> <th></th> <th>Not recommended</th> <th>Recommended</th> </tr> </thead> <tbody> <tr> <td>Single-sided mounting</td> <td></td> <td> A support pin is not to be underneath the capacitor.</td> </tr> <tr> <td>Double-sides mounting</td> <td></td> <td></td> </tr> </tbody> </table> <p>When the centering jaw is worn out, it may give mechanical impact on the capacitors to cause crack. Please control the close up dimension of the centering jaw and provide sufficient preventive maintenance and replacement of it.</p> <p>4-2. Amount of adhesive</p>  <p>Example : C2012 [CC0805], C3216 [CC1206]</p> <table border="1" data-bbox="655 1832 1209 2000"> <tbody> <tr> <td>a</td> <td>0.2mm min.</td> </tr> <tr> <td>b</td> <td>70 ~ 100µm</td> </tr> <tr> <td>c</td> <td>Do not touch the solder land</td> </tr> </tbody> </table> | | Not recommended | Recommended | Single-sided mounting |  |  A support pin is not to be underneath the capacitor. | Double-sides mounting |  |  | a | 0.2mm min. | b | 70 ~ 100µm | c | Do not touch the solder land |
| | Not recommended | Recommended | | | | | | | | | | | | | | | |
| Single-sided mounting |  |  A support pin is not to be underneath the capacitor. | | | | | | | | | | | | | | | |
| Double-sides mounting |  |  | | | | | | | | | | | | | | | |
| a | 0.2mm min. | | | | | | | | | | | | | | | | |
| b | 70 ~ 100µm | | | | | | | | | | | | | | | | |
| c | Do not touch the solder land | | | | | | | | | | | | | | | | |

| No. | Process | Condition | | | | | | | | | | | |
|------------------|------------------|---|----------------|------------------|--|---------------|----------------|------------------|----------|---------|--------------|----------|---------|
| 5 | Soldering | <p>5-1. Flux selection Flux can seriously affect the performance of capacitors. Confirm the following to select the appropriate flux.</p> <ol style="list-style-type: none"> 1) It is recommended to use a mildly activated rosin flux (less than 0.1wt% chlorine). Strong flux is not recommended. 2) Excessive flux must be avoided. Please provide proper amount of flux. 3) When water-soluble flux is used, enough washing is necessary. <p>5-2. Recommended soldering profile : Reflow method Refer to the following temperature profile at Reflow soldering.</p> <div style="text-align: center;"> <p>Reflow soldering</p> </div> <p>Reflow soldering is recommended for C1608,C2012,C3216 types, but only reflow soldering is allowed for other case sizes.</p> <p>5-3. Recommended soldering peak temp and peak temp duration for Reflow soldering Pb free solder is recommended, but if Sn-37Pb must be used, refer to below.</p> <table border="1" style="margin-left: auto; margin-right: auto;"> <thead> <tr> <th data-bbox="592 1272 839 1323" rowspan="2">Temp./Duration</th> <th colspan="2" data-bbox="839 1272 1334 1323">Reflow soldering</th> </tr> <tr> <th data-bbox="839 1323 1086 1384">Peak temp(°C)</th> <th data-bbox="1086 1323 1334 1384">Duration(sec.)</th> </tr> </thead> <tbody> <tr> <td data-bbox="592 1384 839 1444">Lead Free Solder</td> <td data-bbox="839 1384 1086 1444">260 max.</td> <td data-bbox="1086 1384 1334 1444">10 max.</td> </tr> <tr> <td data-bbox="592 1444 839 1505">Sn-Pb Solder</td> <td data-bbox="839 1444 1086 1505">230 max.</td> <td data-bbox="1086 1444 1334 1505">20 max.</td> </tr> </tbody> </table> <p>Recommended solder compositions Lead Free Solder : Sn-3.0Ag-0.5Cu</p> | Temp./Duration | Reflow soldering | | Peak temp(°C) | Duration(sec.) | Lead Free Solder | 260 max. | 10 max. | Sn-Pb Solder | 230 max. | 20 max. |
| Temp./Duration | Reflow soldering | | | | | | | | | | | | |
| | Peak temp(°C) | Duration(sec.) | | | | | | | | | | | |
| Lead Free Solder | 260 max. | 10 max. | | | | | | | | | | | |
| Sn-Pb Solder | 230 max. | 20 max. | | | | | | | | | | | |

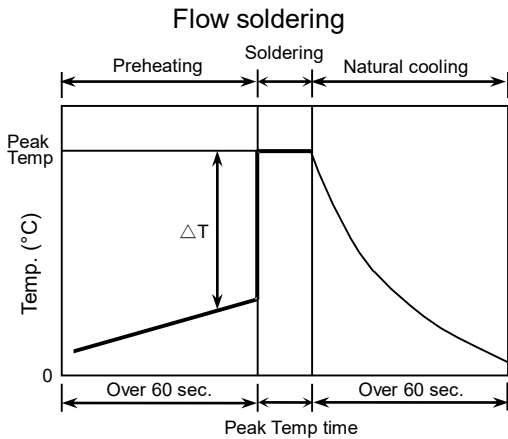
| No. | Process | Condition | | | | | | | | | | | | | | | | | | | | | | | | | |
|------------------|---|---|----------------|----------------|--|---------------|----------------|--------|--|--|------------------|----------|--------|--------------|----------|--------|-----------|-----------|------------|------------------|---|---------------------|--|---------------------|----------------|---|---------------------|
| 5 | Soldering | <p>5-4. Soldering profile : Flow method (Unrecommend) Refer to the following temperature profile at Flow soldering.</p> <div style="text-align: center;">  <p>The graph shows a temperature profile for flow soldering. The y-axis is labeled 'Temp. (°C)' and the x-axis is labeled 'Peak Temp time'. The profile is divided into three phases: 'Preheating', 'Soldering', and 'Natural cooling'. The 'Preheating' phase shows a linear increase in temperature from 0 to a peak level, with a duration of 'Over 60 sec.' and a temperature difference ΔT indicated. The 'Soldering' phase is a constant horizontal line at the peak temperature, also with a duration of 'Over 60 sec.'. The 'Natural cooling' phase shows a smooth, exponential-like decrease in temperature back to 0, with a duration of 'Over 60 sec.'.</p> </div> <p>Reflow soldering is recommended for C1608,C2012,C3216 types.</p> <p>5-5. Recommended soldering peak temp and peak temp duration for Flow soldering Pb free solder is recommended, but if Sn-37Pb must be used, refer to below.</p> <table border="1" data-bbox="587 918 1332 1160"> <thead> <tr> <th rowspan="2">Temp./Duration</th> <th colspan="2">Flow soldering</th> </tr> <tr> <th>Peak temp(°C)</th> <th>Duration(sec.)</th> </tr> </thead> <tbody> <tr> <td>Solder</td> <td></td> <td></td> </tr> <tr> <td>Lead Free Solder</td> <td>260 max.</td> <td>5 max.</td> </tr> <tr> <td>Sn-Pb Solder</td> <td>250 max.</td> <td>3 max.</td> </tr> </tbody> </table> <p>Recommended solder compositions Lead Free Solder : Sn-3.0Ag-0.5Cu</p> <p>5-6. Avoiding thermal shock</p> <p>1) Preheating condition</p> <table border="1" data-bbox="539 1344 1412 1585"> <thead> <tr> <th>Soldering</th> <th>Case size</th> <th>Temp. (°C)</th> </tr> </thead> <tbody> <tr> <td rowspan="2">Reflow soldering</td> <td>C1005(CC0402),C1608(CC0603), C2012(CC0805),C3216(CC1206)</td> <td>$\Delta T \leq 150$</td> </tr> <tr> <td>C3225(CC1210), C4532(CC1812), C5750(CC2220)</td> <td>$\Delta T \leq 130$</td> </tr> <tr> <td>Flow soldering</td> <td>C1608(CC0603),C2012(CC0805), C3216(CC1206)</td> <td>$\Delta T \leq 150$</td> </tr> </tbody> </table> <p>2) Cooling condition Natural cooling using air is recommended. If the chips are dipped into a solvent for cleaning, the temperature difference (ΔT) must be less than 100°C.</p> | Temp./Duration | Flow soldering | | Peak temp(°C) | Duration(sec.) | Solder | | | Lead Free Solder | 260 max. | 5 max. | Sn-Pb Solder | 250 max. | 3 max. | Soldering | Case size | Temp. (°C) | Reflow soldering | C1005(CC0402),C1608(CC0603), C2012(CC0805),C3216(CC1206) | $\Delta T \leq 150$ | C3225(CC1210), C4532(CC1812), C5750(CC2220) | $\Delta T \leq 130$ | Flow soldering | C1608(CC0603),C2012(CC0805), C3216(CC1206) | $\Delta T \leq 150$ |
| Temp./Duration | Flow soldering | | | | | | | | | | | | | | | | | | | | | | | | | | |
| | Peak temp(°C) | Duration(sec.) | | | | | | | | | | | | | | | | | | | | | | | | | |
| Solder | | | | | | | | | | | | | | | | | | | | | | | | | | | |
| Lead Free Solder | 260 max. | 5 max. | | | | | | | | | | | | | | | | | | | | | | | | | |
| Sn-Pb Solder | 250 max. | 3 max. | | | | | | | | | | | | | | | | | | | | | | | | | |
| Soldering | Case size | Temp. (°C) | | | | | | | | | | | | | | | | | | | | | | | | | |
| Reflow soldering | C1005(CC0402),C1608(CC0603), C2012(CC0805),C3216(CC1206) | $\Delta T \leq 150$ | | | | | | | | | | | | | | | | | | | | | | | | | |
| | C3225(CC1210), C4532(CC1812), C5750(CC2220) | $\Delta T \leq 130$ | | | | | | | | | | | | | | | | | | | | | | | | | |
| Flow soldering | C1608(CC0603),C2012(CC0805), C3216(CC1206) | $\Delta T \leq 150$ | | | | | | | | | | | | | | | | | | | | | | | | | |

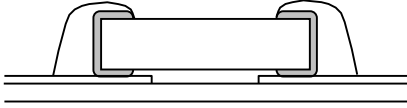
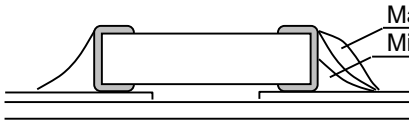
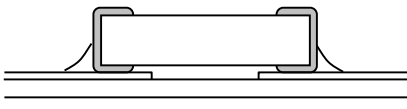
| No. | Process | Condition |
|-----|-----------|---|
| 5 | Soldering | <p>5-7. Amount of solder Excessive solder will induce higher tensile force in chip capacitors when temperature changes and it may result in chip cracking. In sufficient solder may detach the capacitors from the P.C.board.</p> <hr/> <div style="display: flex; justify-content: space-between;"> <div data-bbox="496 394 619 456">Excessive solder</div> <div data-bbox="662 394 1070 501">  </div> <div data-bbox="1123 380 1414 465">Higher tensile force in chip capacitors to cause crack</div> </div> <hr/> <div style="display: flex; justify-content: space-between;"> <div data-bbox="496 562 612 591">Adequate</div> <div data-bbox="683 517 1094 647">  </div> </div> <hr/> <div style="display: flex; justify-content: space-between;"> <div data-bbox="496 701 628 763">Insufficient solder</div> <div data-bbox="662 701 1070 808">  </div> <div data-bbox="1123 669 1414 790">Low robustness may cause contact failure or chip capacitors come off the P.C.board.</div> </div> <hr/> <p>5-8. Sn-Zn solder Sn-Zn solder affects product reliability. Please contact TDK in advance when utilize Sn-Zn solder.</p> <p>5-9. Countermeasure for tombstone The misalignment between the mounted positions of the capacitors and the land patterns should be minimized. The tombstone phenomenon may occur especially the capacitors are mounted (in longitudinal direction) in the same direction of the reflow soldering. (Refer to JEITA RCR-2335C Annex A (Informative), Recommendations to prevent the tombstone phenomenon.)</p> |

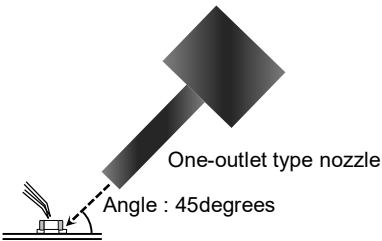
| No. | Process | Condition | | | | | | | | | | | | |
|----------------------|---|--|----------------------|--------------|--------------|-----------|--------------|----------------|---------|---|-----------------|------------------------|------------------|--|
| 6 | Solder repairing | <p>Solder repairing is unavoidable, refer to below.</p> <p>6-1.Soldering rework using spot heater Heat stress during rework may possibly be reduced by using a spot heater (also called a “blower”) rather than a soldering iron. It is applied only to adding solder in the case of insufficient solder amount.</p> <p>1) Reworking using a spot heater may suppress the occurrence of cracks in the capacitor compared to using a soldering iron. A spot heater can heat up a capacitor uniformly with a small heat gradient which leads to lower thermal stress caused by quick heating and cooling or localized heating. Moreover, where ultra-small capacitors are mounted close together on a printed circuit board, reworking with a spot heater can eliminate the risk of direct contact between the tip of a soldering iron and a capacitor.</p> <p>2) Rework condition If the blower nozzle of a spot heater is too close to a capacitor, a crack in the capacitor may occur due to heat stress. Below are recommendations for avoiding such an occurrence. Keep more than 5mm between a capacitor and a spot heater nozzle. The blower temperature of the spot heater shall be lower than 400°C. The airflow shall be set as weak as possible. The diameter of the nozzle is recommended to be 2mm(one-outlet type).The size is standard and common. Duration of blowing hot air is recommended to be 10s or less for C1608(CC0603), C2012(CC0805) and C3216(CC1206), and 30s or less for C3225(CC1210), C4532(CC1812) and C5750(CC2220), considering surface area of the capacitor and melting temperature of solder. The angle between the nozzle and the capacitor is recommended to be 45degrees in order to work easily and to avoid partial area heating. As is the case when using a soldering iron, preheating reduces thermal stress on capacitors and improves operating efficiency.</p> <p>• Recommended rework condition (Consult the component manufactures for details.)</p> <table border="1" data-bbox="507 1205 1453 1556"> <tbody> <tr> <td>Distance from nozzle</td> <td>5mm and over</td> </tr> <tr> <td>Nozzle angle</td> <td>45degrees</td> </tr> <tr> <td>Nozzle temp.</td> <td>400°C and less</td> </tr> <tr> <td>Airflow</td> <td>Set as weak as possible (The airflow shall be the minimum value necessary for solder to melt in the conditions mentioned above.)</td> </tr> <tr> <td>Nozzle diameter</td> <td>ø2mm (one-outlet type)</td> </tr> <tr> <td>Blowing duration</td> <td>10s and less (C1608[CC0603], C2012[CC0805], C3216[CC1206]) 30s and less (C3225[CC1210], C4532[CC1812], C5750[CC2220])</td> </tr> </tbody> </table> <p>• Example of recommended spot heater use</p>  <p>3) Amount of solder should be suitable to form a proper fillet shape. Excess solder causes mechanical and thermal stress on a capacitor and results in cracks. Insufficient solder causes weak adherence of the capacitor to the substrate and may result in detachment of a capacitor and deteriorate reliability of the printed wiring board. See the example of appropriate solder fillet shape for 5-5.Amount of solder.</p> | Distance from nozzle | 5mm and over | Nozzle angle | 45degrees | Nozzle temp. | 400°C and less | Airflow | Set as weak as possible (The airflow shall be the minimum value necessary for solder to melt in the conditions mentioned above.) | Nozzle diameter | ø2mm (one-outlet type) | Blowing duration | 10s and less (C1608[CC0603], C2012[CC0805], C3216[CC1206]) 30s and less (C3225[CC1210], C4532[CC1812], C5750[CC2220]) |
| Distance from nozzle | 5mm and over | | | | | | | | | | | | | |
| Nozzle angle | 45degrees | | | | | | | | | | | | | |
| Nozzle temp. | 400°C and less | | | | | | | | | | | | | |
| Airflow | Set as weak as possible (The airflow shall be the minimum value necessary for solder to melt in the conditions mentioned above.) | | | | | | | | | | | | | |
| Nozzle diameter | ø2mm (one-outlet type) | | | | | | | | | | | | | |
| Blowing duration | 10s and less (C1608[CC0603], C2012[CC0805], C3216[CC1206]) 30s and less (C3225[CC1210], C4532[CC1812], C5750[CC2220]) | | | | | | | | | | | | | |

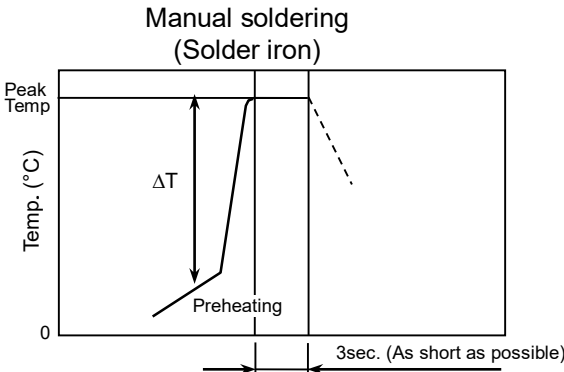
| No. | Process | Condition | | | | | | | | | | | | | | | | | | | | |
|--|---|--|-------------|------------|-----------------|-------------|------------|--|----------|--------|---------|-----------|---|----------|-----------|-----------|------------|------------------|---|---------------------|--|---------------------|
| 6 | Solder repairing | <p>6-2. Solder repair by solder iron</p> <p>1) Selection of the soldering iron tip Tip temperature of solder iron varies by its type, P.C.board material and solder land size. The higher the tip temperature, the quicker the operation. However, heat shock may cause a crack in the chip capacitors. Please make sure the tip temp. before soldering and keep the peak temp and time in accordance with following recommended condition.</p> <div style="text-align: center;">  </div> <p style="text-align: center;">Recommended solder iron condition (Sn-Pb Solder and Lead Free Solder)</p> <table border="1" style="width: 100%; border-collapse: collapse;"> <thead> <tr> <th>Case size</th> <th>Temp. (°C)</th> <th>Duration (sec.)</th> <th>Wattage (W)</th> <th>Shape (mm)</th> </tr> </thead> <tbody> <tr> <td>C1005(CC0402) C1608(CC0603) C2012(CC0805) C3216(CC1206)</td> <td>350 max.</td> <td rowspan="2">3 max.</td> <td rowspan="2">20 max.</td> <td rowspan="2">ø3.0 max.</td> </tr> <tr> <td>C3225(CC1210) C4532(CC1812) C5750(CC2220)</td> <td>280 max.</td> </tr> </tbody> </table> <p>* Please preheat the chip capacitors with the condition in 6-3 to avoid the thermal shock.</p> <p>2) Direct contact of the soldering iron with ceramic dielectric of chip capacitors may cause crack. Do not touch the ceramic dielectric and the terminations by solder iron.</p> <p>6-3. Avoiding thermal shock</p> <p>Preheating condition</p> <table border="1" style="width: 100%; border-collapse: collapse;"> <thead> <tr> <th>Soldering</th> <th>Case size</th> <th>Temp. (°C)</th> </tr> </thead> <tbody> <tr> <td rowspan="2">Manual soldering</td> <td>C1005(CC0402),C1608(CC0603), C2012(CC0805),C3216(CC1206)</td> <td>$\Delta T \leq 150$</td> </tr> <tr> <td>C3225(CC1210), C4532(CC1812), C5750(CC2220)</td> <td>$\Delta T \leq 130$</td> </tr> </tbody> </table> | Case size | Temp. (°C) | Duration (sec.) | Wattage (W) | Shape (mm) | C1005(CC0402) C1608(CC0603) C2012(CC0805) C3216(CC1206) | 350 max. | 3 max. | 20 max. | ø3.0 max. | C3225(CC1210) C4532(CC1812) C5750(CC2220) | 280 max. | Soldering | Case size | Temp. (°C) | Manual soldering | C1005(CC0402),C1608(CC0603), C2012(CC0805),C3216(CC1206) | $\Delta T \leq 150$ | C3225(CC1210), C4532(CC1812), C5750(CC2220) | $\Delta T \leq 130$ |
| Case size | Temp. (°C) | Duration (sec.) | Wattage (W) | Shape (mm) | | | | | | | | | | | | | | | | | | |
| C1005(CC0402) C1608(CC0603) C2012(CC0805) C3216(CC1206) | 350 max. | 3 max. | 20 max. | ø3.0 max. | | | | | | | | | | | | | | | | | | |
| C3225(CC1210) C4532(CC1812) C5750(CC2220) | 280 max. | | | | | | | | | | | | | | | | | | | | | |
| Soldering | Case size | Temp. (°C) | | | | | | | | | | | | | | | | | | | | |
| Manual soldering | C1005(CC0402),C1608(CC0603), C2012(CC0805),C3216(CC1206) | $\Delta T \leq 150$ | | | | | | | | | | | | | | | | | | | | |
| | C3225(CC1210), C4532(CC1812), C5750(CC2220) | $\Delta T \leq 130$ | | | | | | | | | | | | | | | | | | | | |

| No. | Process | Condition |
|-----|--------------------------------------|---|
| 7 | Cleaning | <p>1) If an unsuitable cleaning fluid is used, flux residue or some foreign articles may stick to chip capacitors surface to deteriorate especially the insulation resistance.</p> <p>2) If cleaning condition is not suitable, it may damage the chip capacitors.</p> <p>2)-1. Insufficient washing</p> <p>(1) Terminal electrodes may corrode by Halogen in the flux.</p> <p>(2) Halogen in the flux may adhere on the surface of capacitors, and lower the insulation resistance.</p> <p>(3) Water soluble flux has higher tendency to have above mentioned problems (1) and (2).</p> <p>2)-2. Excessive washing</p> <p>When ultrasonic cleaning is used, excessively high ultrasonic energy output can affect the connection between the ceramic chip capacitor's body and the terminal electrode. To avoid this, following is the recommended condition.</p> <p style="text-align: center;">Power : 20 W/l max. Frequency : 40 kHz max. Washing time : 5 minutes max.</p> <p>2)-3. If the cleaning fluid is contaminated, density of Halogen increases, and it may bring the same result as insufficient cleaning.</p> |
| 8 | Coating and molding of the P.C.board | <p>1) When the P.C.board is coated, please verify the quality influence on the product.</p> <p>2) Please verify carefully that there is no harmful decomposing or reaction gas emission during curing which may damage the chip capacitors.</p> <p>3) Please verify the curing temperature.</p> |

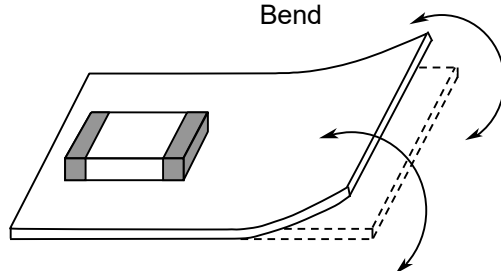
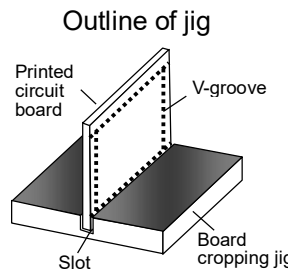
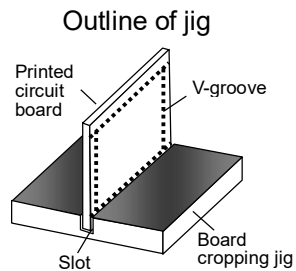
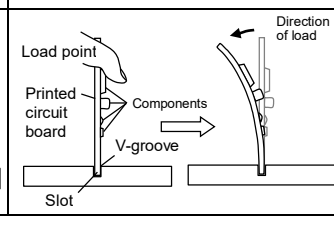
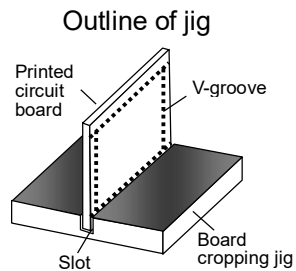
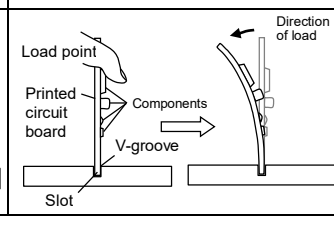
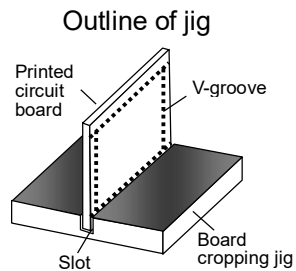
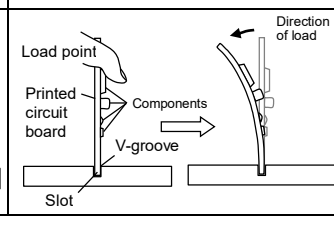
| No. | Process | Condition | | | | |
|--|---|---|-------------|---------------|--|---|
| 9 | Handling after chip mounted ⚠ Caution | <p>1) Please pay attention not to bend or distort the P.C.board after soldering in handling otherwise the chip capacitors may crack.</p> <div style="display: flex; justify-content: space-around;"> <div style="text-align: center;"> <p>Bend</p>  </div> <div style="text-align: center;"> <p>Twist</p>  </div> </div> <p>2) Printed circuit board cropping should not be carried out by hand, but by using the proper tooling. Printed circuit board cropping should be carried out using a board cropping jig as shown in the following figure or a board cropping apparatus to prevent inducing mechanical stress on the board.</p> <p>(1) Example of a board cropping jig</p> <p>Recommended example: The board should be pushed from the back side, close to the cropping jig so that the board is not bent and the stress applied to the capacitor is compressive.</p> <p>Unrecommended example: If the pushing point is far from the cropping jig and the pushing direction is from the front side of the board, large tensile stress is applied to the capacitor, which may cause cracks.</p> <div style="display: flex; justify-content: space-around; align-items: flex-start;"> <div style="text-align: center;"> <p>Outline of jig</p>  </div> <table border="1" style="width: 100%;"> <thead> <tr> <th data-bbox="766 1030 1101 1075">Recommended</th> <th data-bbox="1101 1030 1436 1075">Unrecommended</th> </tr> </thead> <tbody> <tr> <td data-bbox="766 1075 1101 1299">  </td> <td data-bbox="1101 1075 1436 1299">  </td> </tr> </tbody> </table> </div> | Recommended | Unrecommended |  |  |
| Recommended | Unrecommended | | | | | |
|  |  | | | | | |

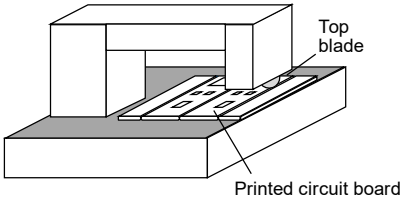
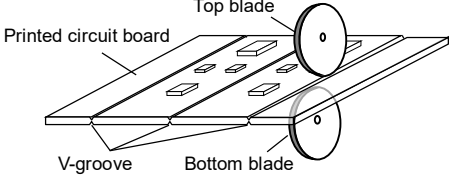
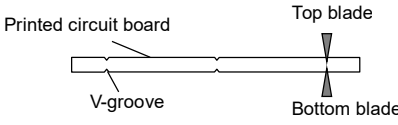
| No. | Process | Condition | | | | | | | | | | | | | | | | | | |
|---|--|---|--|---------------|--|--|--|-------------------------|-------------------------|-------------------------|---|--|--|--|------|-----------------|-------------|---------------|--|---|
| 9 | Handling after chip mounted  Caution | <p>(2) Example of a board cropping machine</p> <p>An outline of a printed circuit board cropping machine is shown below. The top and bottom blades are aligned with one another along the lines with the V-grooves on printed circuit board when cropping the board.</p> <p>Unrecommended example: Misalignment of blade position between top and bottom, right and left, or front and rear blades may cause a crack in the capacitor.</p> <div style="display: flex; justify-content: space-around;"> <div data-bbox="564 504 967 768"> <p>Outline of machine</p>  </div> <div data-bbox="967 504 1417 745"> <p>Principle of operation</p>  </div> </div> <div style="text-align: center; margin-top: 10px;"> <p>Cross-section diagram</p>  </div> <table border="1" style="width: 100%; margin-top: 20px; border-collapse: collapse;"> <thead> <tr> <th data-bbox="646 985 826 1070">Recommended</th> <th colspan="3" data-bbox="826 985 1358 1070">Unrecommended</th> </tr> <tr> <td></td> <th data-bbox="826 1070 1002 1120">Top-bottom misalignment</th> <th data-bbox="1002 1070 1173 1120">Left-right misalignment</th> <th data-bbox="1173 1070 1358 1120">Front-rear misalignment</th> </tr> </thead> <tbody> <tr> <td data-bbox="646 1097 826 1406"> <p>Top blade</p>  <p>Board</p> <p>Bottom blade</p> </td> <td data-bbox="826 1097 1002 1406"> <p>Top blade</p>  <p>Bottom blade</p> </td> <td data-bbox="1002 1097 1173 1406"> <p>Top blade</p>  <p>Bottom blade</p> </td> <td data-bbox="1173 1097 1358 1406"> <p>Top blade</p>  <p>Bottom blade</p> </td> </tr> </tbody> </table> <p>3) When functional check of the P.C. board is performed, check pin pressure tends to be adjusted higher for fear of loose contact. But if the pressure is excessive and bend the P.C. board, it may crack the chip capacitors or peel the terminations off. Please adjust the check pins not to bend the P.C. board.</p> <table border="1" style="width: 100%; margin-top: 20px; border-collapse: collapse;"> <thead> <tr> <th data-bbox="478 1653 619 1715">Item</th> <th data-bbox="619 1653 1037 1715">Not recommended</th> <th data-bbox="1037 1653 1436 1715">Recommended</th> </tr> </thead> <tbody> <tr> <td data-bbox="478 1715 619 1951">Board bending</td> <td data-bbox="619 1715 1037 1951">  <p>Termination peeling</p> <p>Check pin</p> </td> <td data-bbox="1037 1715 1436 1951">  <p>Support pin</p> <p>Check pin</p> </td> </tr> </tbody> </table> | Recommended | Unrecommended | | | | Top-bottom misalignment | Left-right misalignment | Front-rear misalignment | <p>Top blade</p>  <p>Board</p> <p>Bottom blade</p> | <p>Top blade</p>  <p>Bottom blade</p> | <p>Top blade</p>  <p>Bottom blade</p> | <p>Top blade</p>  <p>Bottom blade</p> | Item | Not recommended | Recommended | Board bending |  <p>Termination peeling</p> <p>Check pin</p> |  <p>Support pin</p> <p>Check pin</p> |
| Recommended | Unrecommended | | | | | | | | | | | | | | | | | | | |
| | Top-bottom misalignment | Left-right misalignment | Front-rear misalignment | | | | | | | | | | | | | | | | | |
| <p>Top blade</p>  <p>Board</p> <p>Bottom blade</p> | <p>Top blade</p>  <p>Bottom blade</p> | <p>Top blade</p>  <p>Bottom blade</p> | <p>Top blade</p>  <p>Bottom blade</p> | | | | | | | | | | | | | | | | | |
| Item | Not recommended | Recommended | | | | | | | | | | | | | | | | | | |
| Board bending |  <p>Termination peeling</p> <p>Check pin</p> |  <p>Support pin</p> <p>Check pin</p> | | | | | | | | | | | | | | | | | | |

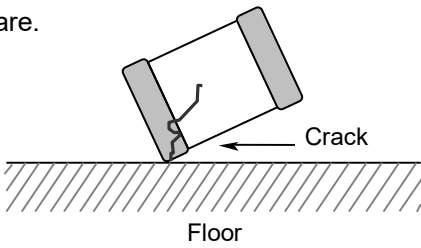
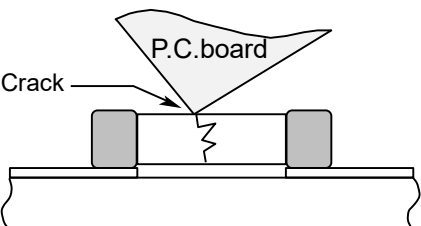
| No. | Process | Condition |
|-----|---|---|
| 10 | Handling of loose chip capacitors | <p>1) If dropped the chip capacitors may crack. Once dropped do not use it. Especially, the large case sized chip capacitors are tendency to have cracks easily, so please handle with care.</p>  <p>2) Piling the P.C.board after mounting for storage or handling, the corner of the P.C. board may hit the chip capacitors of another board to cause crack.</p>  |
| 11 | Capacitance aging | The capacitors (Class 2) have aging in the capacitance. They may not be used in precision time constant circuit. In case of the time constant circuit, the evaluation should be done well. |
| 12 | Estimated life and estimated failure rate of capacitors | <p>As per the estimated life and the estimated failure rate depend on the temperature and the voltage. This can be calculated by the equation described in JEITA RCR-2335C Annex F (Informative) Calculation of the estimated lifetime and the estimated failure rate (Voltage acceleration coefficient : 3 multiplication rule, Temperature acceleration coefficient : 10°C rule)</p> <p>The failure rate can be decreased by reducing the temperature and the voltage but they will not be guaranteed.</p> |

| No. | Process | Condition |
|-----|---|--|
| 13 | Caution during operation of equipment | <p>1) A capacitor shall not be touched directly with bare hands during operation in order to avoid electric shock. Electric energy held by the capacitor may be discharged through the human body when touched with a bare hand. Even when the equipment is off, a capacitor may stay charged. The capacitor should be handled after being completely discharged using a resistor.</p> <p>2) The terminals of a capacitor shall not be short-circuited by any accidental contact with a conductive object. A capacitor shall not be exposed to a conductive liquid such as an acid or alkali solution. A conductive object or liquid, such as acid and alkali, between the terminals may lead to the breakdown of a capacitor due to short circuit.</p> <p>3) Confirm that the environment to which the equipment will be exposed during transportation and operation meets the specified conditions. Do not to use the equipment in the following environments.</p> <p>(1) Environment where a capacitor is splattered with water or oil (2) Environment where a capacitor is exposed to direct sunlight (3) Environment where a capacitor is exposed to Ozone, ultraviolet rays or radiation (4) Environment where a capacitor exposed to corrosive gas(e.g. hydrogen sulfide, sulfur dioxide, chlorine. ammonia gas etc.) (5) Environment where a capacitor exposed to vibration or mechanical shock exceeding the specified limits. (6) Atmosphere change with causes condensation</p> |
| 14 | Others  Caution | <p>The products listed on this specification sheet are intended for use in general electronic equipment (AV equipment, telecommunications equipment, home appliances, amusement equipment, computer equipment, personal equipment, office equipment, measurement equipment, industrial robots) under a normal operation and use condition.</p> <p>The products are not designed or warranted to meet the requirements of the applications listed below, whose performance and/or quality require a more stringent level of safety or reliability, or whose failure, malfunction or trouble could cause serious damage to society, person or property. Please understand that we are not responsible for any damage or liability caused by use of the products in any of the applications below or for any other use exceeding the range or conditions set forth in this specification sheet. If you intend to use the products in the applications listed below or if you have special requirements exceeding the range or conditions set forth in this specification, please contact us.</p> <p>(1) Aerospace/Aviation equipment (2) Transportation equipment (cars, electric trains, ships, etc.) (3) Medical equipment (Excepting Pharmaceutical Affairs Law classification Class1, 2) (4) Power-generation control equipment (5) Atomic energy-related equipment (6) Seabed equipment (7) Transportation control equipment (8) Public information-processing equipment (9) Military equipment (10) Electric heating apparatus, burning equipment (11) Disaster prevention/crime prevention equipment (12) Safety equipment (13) Other applications that are not considered general-purpose applications</p> <p>When designing your equipment even for general-purpose applications, you are kindly requested to take into consideration securing protection circuit/device or providing backup circuits in your equipment.</p> |

13. TAPE PACKAGING SPECIFICATION

1. CONSTRUCTION AND DIMENSION OF TAPING

1-1. Dimensions of carrier tape

Dimensions of paper tape shall be according to Appendix 3, 4.

Dimensions of plastic tape shall be according to Appendix 5, 6.

1-2. Bulk part and leader of taping

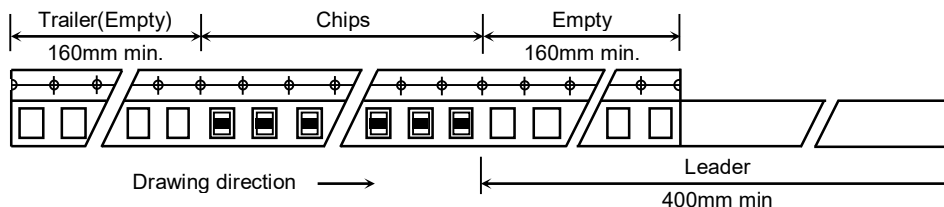

1-3. Dimensions of reel

Dimensions of $\varnothing 178$ reel shall be according to Appendix 7, 8.

Dimensions of $\varnothing 330$ reel shall be according to Appendix 9, 10.

1-4. Structure of taping

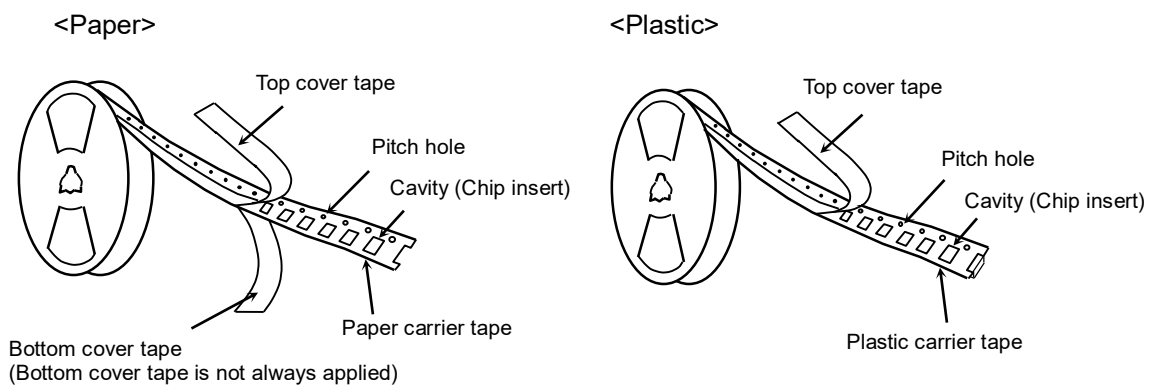

2. CHIP QUANTITY

Please refer to detail page on TDK web.

3. PERFORMANCE SPECIFICATIONS

3-1. Fixing peeling strength (top tape)

$$0.05\text{N} < \text{Peeling strength} < 0.7\text{N}$$

<Paper>

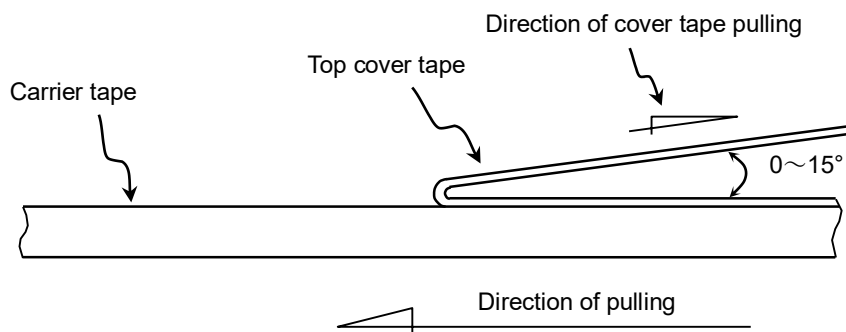

〔 Paper tape should not adhere to top cover tape when pull the cover tape. 〕

<Plastic>

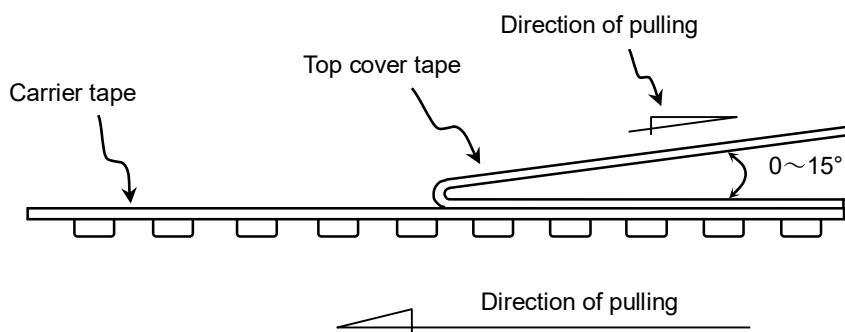

3-2. Carrier tape shall be flexible enough to be wound around a minimum radius of 30mm with components in tape.

3-3. The missing of components shall be less than 0.1%

3-4. Components shall not stick to fixing tape.

3-5. When removing the cover tape, there shall not be difficulties by unfitting clearance gap, burrs and crushes of cavities. Also the sprocket holes shall not be covered by absorbing dust into the suction nozzle.

Appendix 3

Paper Tape

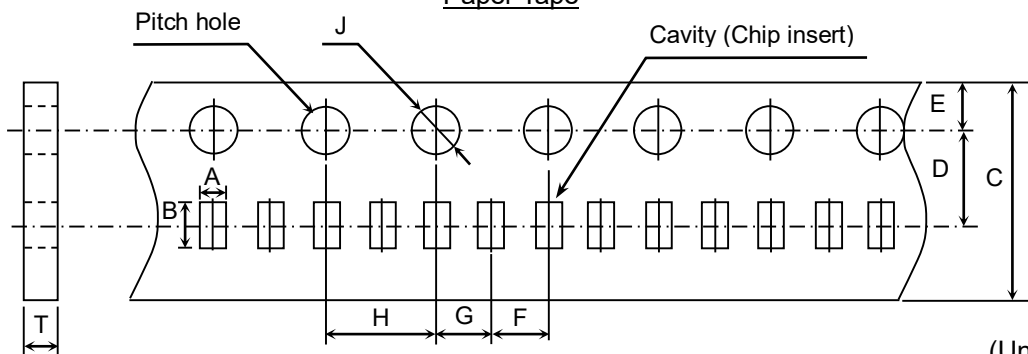

(Unit : mm)

| Symbol | A | B | C | D | E | F |
|-------------------|------------------------|------------------------|-------------|-------------|-------------|-------------|
| Case size | | | | | | |
| C1005 [CC0402] | (0.65) * (0.73) | (1.15) * (1.23) | 8.00 ± 0.30 | 3.50 ± 0.05 | 1.75 ± 0.10 | 2.00 ± 0.05 |

| Symbol | G | H | J | T |
|-------------------|-------------|-------------|--------------------------------------|--------------------------|
| Case size | | | | |
| C1005 [CC0402] | 2.00 ± 0.05 | 4.00 ± 0.10 | ∅ 1.50 ^{+0.10} ₀ | 0.60±0.05 * 0.68±0.05 |

() Reference value.

* Applied to thickness, 0.50±0.10mm and 0.50 +0.15,-0.10mm products.

Appendix 4

Paper Tape

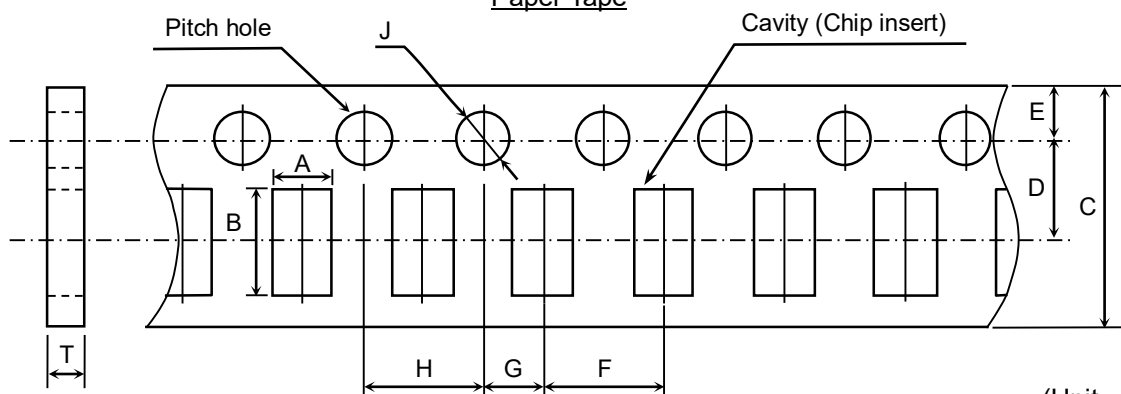

(Unit : mm)

| Symbol | A | B | C | D | E | F |
|-------------------|----------|----------|-------------|-------------|-------------|-------------|
| Case size | | | | | | |
| C1608 [CC0603] | (1.10) | (1.90) | 8.00 ± 0.30 | 3.50 ± 0.05 | 1.75 ± 0.10 | 4.00 ± 0.10 |
| C2012 [CC0805] | (1.50) | (2.30) | | | | |
| C3216 [CC1206] | (1.90) | (3.50) | | | | |

| Symbol | G | H | J | T |
|-------------------|-------------|-------------|--------------------------------------|-----------|
| Case size | | | | |
| C1608 [CC0603] | 2.00 ± 0.05 | 4.00 ± 0.10 | ∅ 1.50 ^{+0.10} ₀ | 1.20 max. |
| C2012 [CC0805] | | | | |
| C3216 [CC1206] | | | | |

() Reference value.

Appendix 5

Plastic Tape

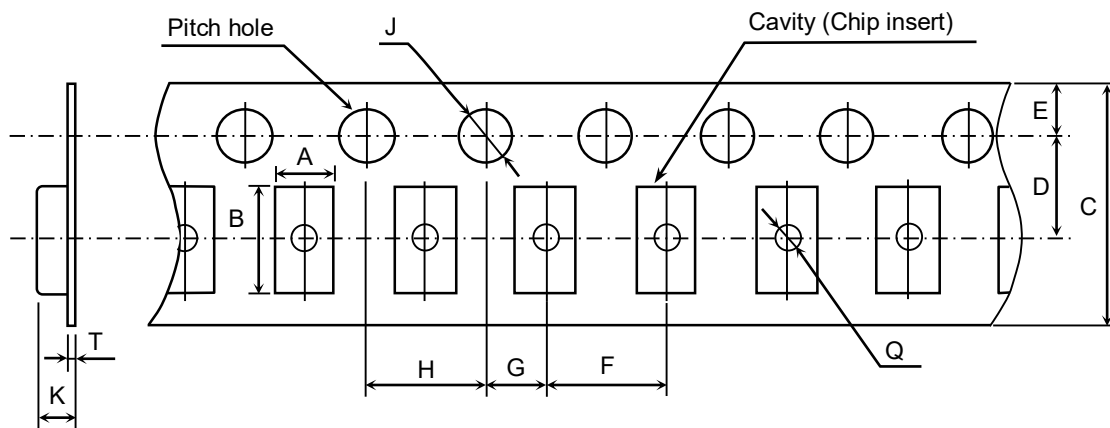

(Unit : mm)

| Symbol | A | B | C | D | E | F |
|-------------------|-------------|-------------|--------------------------------------|---------------------------|-------------|-------------|
| Case size | | | | | | |
| C2012 [CC0805] | (1.50) | (2.30) | 8.0 ± 0.3 *12.0 ± 0.3 | 3.5 ± 0.05 *5.5 ± 0.05 | 1.75 ± 0.10 | 4.00 ± 0.10 |
| C3216 [CC1206] | (1.90) | (3.50) | | | | |
| C3225 [CC1210] | (2.90) | (3.60) | | | | |
| Symbol | G | H | J | K | T | Q |
| Case size | | | | | | |
| C2012 [CC0805] | 2.00 ± 0.05 | 4.00 ± 0.10 | ∅ 1.50 ^{+0.10} ₀ | 2.50 max. | 0.60 max. | ∅ 0.50 min. |
| C3216 [CC1206] | | | | | | |
| C3225 [CC1210] | | | | 3.40 max. | | |

() Reference value.

* Applied to thickness, 2.5mm products.

Exceptionally no hole in the cavity is applied. Please inquire if hole in cavity is mandatory.

Appendix 6

Plastic Tape

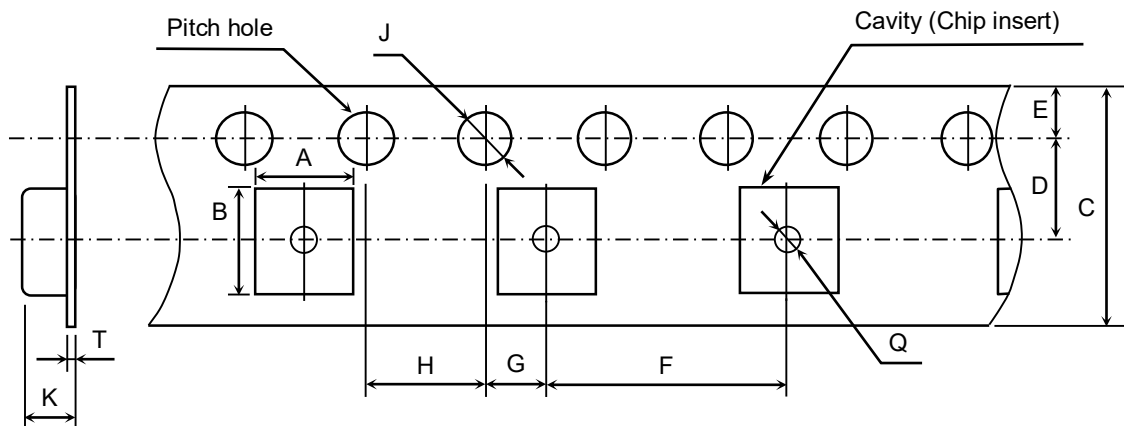

(Unit : mm)

| Symbol | A | B | C | D | E | F |
|-------------------|----------|----------|-------------|-------------|-------------|-------------|
| Case size | | | | | | |
| C4532 [CC1812] | (3.60) | (4.90) | 12.0 ± 0.30 | 5.50 ± 0.05 | 1.75 ± 0.10 | 8.00 ± 0.10 |
| C5750 [CC2220] | (5.40) | (6.10) | | | | |

| Symbol | G | H | J | K | T | Q |
|-------------------|-------------|-------------|--------------------------------------|-----------|-----------|-------------|
| Case size | | | | | | |
| C4532 [CC1812] | 2.00 ± 0.05 | 4.00 ± 0.10 | ∅ 1.50 ^{+0.10} ₀ | 6.50 max. | 0.60 max. | ∅ 1.50 min. |
| C5750 [CC2220] | | | | | | |

() Reference value.

Exceptionally no hole in the cavity is applied. Please inquire if hole in cavity is mandatory.

Appendix 7

Dimensions of reel (Material : Polystyrene)
C1005, C1608, C2012, C3216, C3225

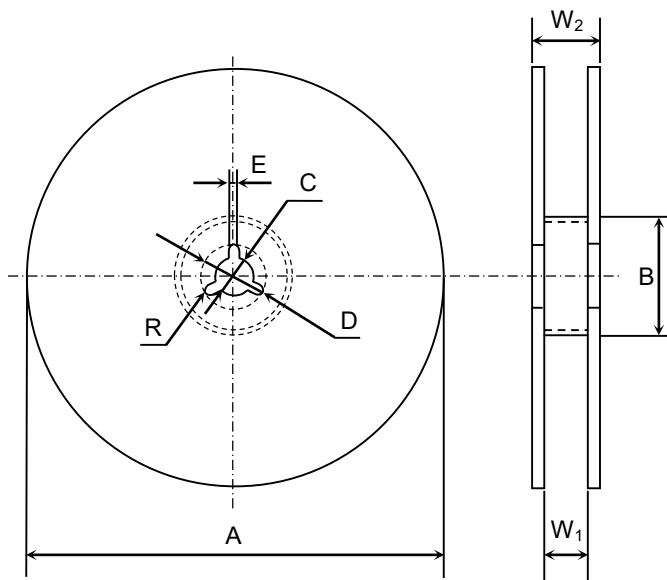

(Unit : mm)

| | | | | | | |
|-----------|----------------|------------|------------|------------|-----------|----------------|
| Symbol | A | B | C | D | E | W ₁ |
| Dimension | ∅ 178 ± 2.0 | ∅ 60 ± 2.0 | ∅ 13 ± 0.5 | ∅ 21 ± 0.8 | 2.0 ± 0.5 | 9.0 ± 0.3 |
| Symbol | W ₂ | R | | | | |
| Dimension | 13.0 ± 1.4 | 1.0 | | | | |

Appendix 8

Dimensions of reel (Material : Polystyrene)
C3225(2.5mm thickness products), C4532, C5750

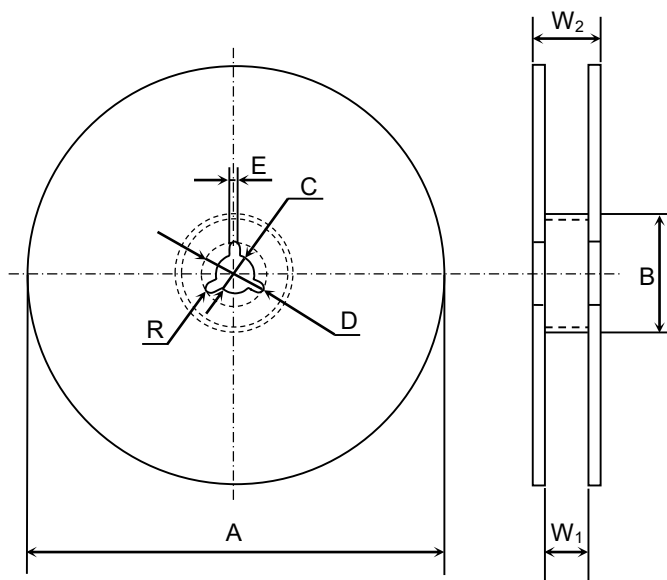

(Unit : mm)

| | | | | | | |
|-----------|----------------|------------|------------|------------|-----------|----------------|
| Symbol | A | B | C | D | E | W ₁ |
| Dimension | ∅ 178 ± 2.0 | ∅ 60 ± 2.0 | ∅ 13 ± 0.5 | ∅ 21 ± 0.8 | 2.0 ± 0.5 | 13.0 ± 0.3 |
| Symbol | W ₂ | R | | | | |
| Dimension | 17.0 ± 1.4 | 1.0 | | | | |

Appendix 9

Dimensions of reel (Material : Polystyrene)
C1005, C1608, C2012, C3216, C3225

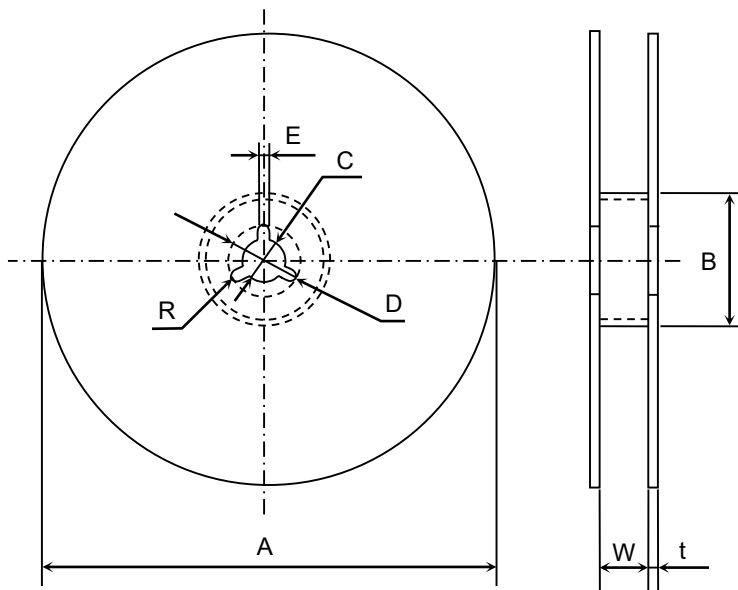

(Unit : mm)

| | | | | | | |
|-----------|-------------------------------|-----------|------------|------------|-----------|------------|
| Symbol | A | B | C | D | E | W |
| Dimension | ∅ 382 max. (Nominal ∅ 330) | ∅ 50 min. | ∅ 13 ± 0.5 | ∅ 21 ± 0.8 | 2.0 ± 0.5 | 10.0 ± 1.5 |
| Symbol | t | R | | | | |
| Dimension | 2.0 ± 0.5 | 1.0 | | | | |

Appendix 10

Dimensions of reel (Material : Polystyrene)
C3225(2.5mm thickness products), C4532, C5750

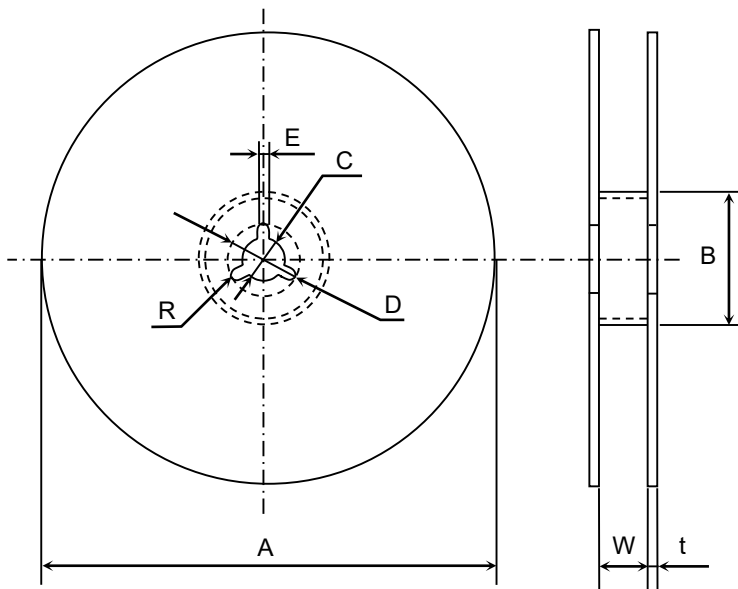

(Unit : mm)

| | | | | | | |
|-----------|-------------------------------|-----------|------------|------------|-----------|------------|
| Symbol | A | B | C | D | E | W |
| Dimension | ∅ 382 max. (Nominal ∅ 330) | ∅ 50 min. | ∅ 13 ± 0.5 | ∅ 21 ± 0.8 | 2.0 ± 0.5 | 14.0 ± 1.5 |
| Symbol | t | R | | | | |
| Dimension | 2.0 ± 0.5 | 1.0 | | | | |

X-ON Electronics

Largest Supplier of Electrical and Electronic Components

Click to view similar products for [Multilayer Ceramic Capacitors MLCC - SMD/SMT](#) category:

Click to view products by [TDK](#) manufacturer:

Other Similar products are found below :

[M39014/01-1467](#) [M39014/02-1218V](#) [M39014/02-1225V](#) [M39014/02-1262V](#) [M39014/02-1301](#) [M39014/22-0631](#) [1210J5000102JCT](#)
[1210J2K00102KXT](#) [1210J5000103KXT](#) [1210J5000223KXT](#) [D55342E07B379BR-TR](#) [D55342E07B523DR-T/R](#) [1812J1K00103KXT](#)
[1812J1K00473KXT](#) [1812J2K00680JCT](#) [1812J4K00102MXT](#) [1812J5000102JCT](#) [1812J5000103JCT](#) [1812J5000682JCT](#) [NIN-FB391JTRF](#)
[NIN-FC2R7JTRF](#) [NPIS27H102MTRF](#) [C1206C101J1GAC](#) [C1608C0G1E472JT000N](#) [C2012C0G2A472J](#) [2220J2K00101JCT](#)
[KHC201E225M76N0T00](#) [LRC-LRF1206LF-01R025FTR1K](#) [1812J1K00222JCT](#) [1812J2K00102KXT](#) [1812J2K00222KXT](#)
[1812J2K00472KXT](#) [2-1622820-7-CUT-TAPE](#) [2220J3K00102KXT](#) [2225J2500824KXT](#) [CCR07CG103KM](#) [CGA2B2C0G1H010C](#)
[CGA2B2C0G1H040C](#) [CGA2B2C0G1H050C](#) [CGA2B2C0G1H060D](#) [CGA2B2C0G1H070D](#) [CGA2B2C0G1H151J](#) [CGA2B2C0G1H1R5C](#)
[CGA2B2C0G1H2R2C](#) [CGA2B2C0G1H3R3C](#) [CGA2B2C0G1H680J](#) [CGA2B2C0G1H6R8D](#) [CGA2B2X8R1H221K](#) [CGA2B2X8R1H472K](#)
[CGA3E1X7R1C474K](#)