

# DELIVERY SPECIFICATION

SPEC. No. A-Soft-i

D A T E : Nov., 2021

To

**Non-Controlled Copy**

CUSTOMER'S PRODUCT NAME	TDK PRODUCT NAME MULTILAYER CERAMIC CHIP CAPACITORS (Soft Termination) Bulk and Tape packaging 【RoHS compliant】 CGA2, CGA3, CGA4, CGA5, CGA6, CGA8, CGA9 Type C0G,NP0,X7R,X7S,X7T,X8R,X8L Characteristics
-------------------------	---

Please return this specification to TDK representatives with your signature.  
 If orders are placed without returned specification, please allow us to judge that specification is accepted by your side.

## RECEIPT CONFIRMATION

DATE:                      YEAR                      MONTH                      DAY

Test conditions in this specification based on AEC-Q200 for automotive application.

TDK Corporation  
 Sales  
 Electronic Components  
 Sales & Marketing Group

Engineering  
 Electronic Components Business Company  
 Ceramic Capacitors Business Group

APPROVED	Person in charge

APPROVED	CHECKED	Person in charge

**SCOPE**

This delivery specification shall be applied to Multilayer ceramic chip capacitors to be delivered to \_\_\_\_\_.

**PRODUCTION PLACES**

Production places defined in this specification shall be TDK Corporation, TDK(Suzhou)Co.,Ltd and TDK Components U.S.A.,Inc.

**PRODUCT NAME**

The name of the product to be defined in this specifications shall be CGA◇◇◇○○○△△□□□×◎※※※S.

**REFERENCE STANDARD**

JIS C 5101-1 : 2010	Fixed capacitors for use in electronic equipment-Part 1: Generic specification
C 5101-21 : 2014	Fixed capacitors for use in electronic equipment-Part21 : Sectional specification : Fixed surface mount multilayer capacitors of ceramic dielectric,Class1
C 5101-22 : 2014	Fixed capacitors for use in electronic equipment-Part22 : Sectional specification : Fixed surface mount multilayer capacitors of ceramic dielectric,Class 2
C 0806-3 : 2014	Packaging of components for automatic handling - Part 3: Packaging of surface mount components on continuous tapes
JEITA RCR-2335 C 2014	Safety application guide for fixed ceramic capacitors for use in electronic equipment

**CONTENTS**

- |   |                                  |
|---|----------------------------------|
| 1. CODE CONSTRUCTION                              | 11. RECOMMENDATION               |
| 2. COMBINATION OF RATED CAPACITANCE AND TOLERANCE | 12. SOLDERING CONDITION          |
| 3. OPERATING TEMPERATURE RANGE                    | 13. CAUTION                      |
| 4. STORING CONDITION AND TERM                     | 14. TAPE PACKAGING SPECIFICATION |
| 5. P.C. BOARD                                     |                                  |
| 6. INDUSTRIAL WASTE DISPOSAL                      |                                  |
| 7. PERFORMANCE                                    |                                  |
| 8. INSIDE STRUCTURE AND MATERIAL                  |                                  |
| 9. CAUTION FOR PRODUCTS WITH SOFT TERMINATION     |                                  |
| 10. PACKAGING                                     |                                  |

**<EXPLANATORY NOTE>**

When the mistrust in the spec arises, this specification is given priority. And it will be confirmed by written spec change after conference of both posts involved.

This specification warrants the quality of the ceramic chip capacitor. Capacitors should be evaluated or confirmed a state of mounted on your product.

If the use of the capacitors goes beyond the bounds of this specification, we can not afford to guarantee.

Division	Date	SPEC. No.
Ceramic Capacitors Business Group	November, 2021	A-Soft-i

## 1. CODE CONSTRUCTION

(Example)	CGA	3	E	2	X7R	1 H	104	K	T	※※※S
	<u>CGA</u>	<u>6</u>	<u>P</u>	<u>3</u>	<u>X7S</u>	<u>1 H</u>	<u>106</u>	<u>K</u>	<u>T</u>	<u>※※※S</u>
	(1)	(2)	(3)	(4)	(5)	(6)	(7)	(8)	(9)	(10)

(1) Series

Symbol	Series
CGA	For automotive application

(2) Type

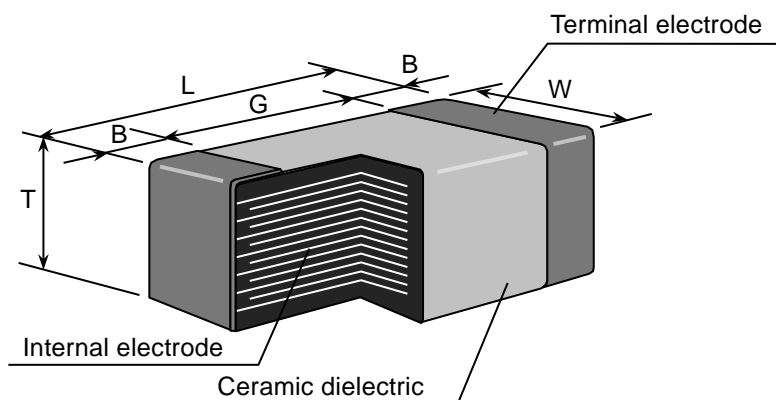

Case size Symbol	Case size (EIA style)	Dimensions (Unit : mm)				
		L	W	T	B	G
2	CGA2 (CC0402)	1.00 <sup>+0.15</sup> <sub>-0.05</sub>	0.50 <sup>+0.10</sup> <sub>-0.05</sub>	0.50 <sup>+0.10</sup> <sub>-0.05</sub>	0.10 min.	0.30 min.
3	CGA3 (CC0603)	1.60 <sup>+0.20</sup> <sub>-0.10</sub>	0.80 <sup>+0.15</sup> <sub>-0.10</sub>	0.80 <sup>+0.15</sup> <sub>-0.10</sub>	0.20 min.	0.30 min.
4	CGA4 (CC0805)	2.00 <sup>+0.45</sup> <sub>-0.20</sub>	1.25 <sup>+0.25</sup> <sub>-0.20</sub>	0.60±0.15	0.20 min.	0.50 min.
				0.85±0.15		
				1.25 <sup>+0.25</sup> <sub>-0.20</sub>		
5	CGA5 (CC1206)	3.20 <sup>+0.40</sup> <sub>-0.20</sub>	1.60 <sup>+0.30</sup> <sub>-0.20</sub>	0.60±0.15	0.20 min.	1.00 min.
				0.85±0.15		
				1.15±0.15		
				1.30±0.20		
6	CGA6 (CC1210)	3.20 <sup>+0.50</sup> <sub>-0.40</sub>	2.50±0.30	1.60 <sup>+0.30</sup> <sub>-0.20</sub>	0.20 min.	—
				2.00 <sup>+0.30</sup> <sub>-0.20</sub>		
				2.30 <sup>+0.30</sup> <sub>-0.20</sub>		
				2.50±0.30		
8	CGA8 (CC1812)	4.50 <sup>+0.50</sup> <sub>-0.40</sub>	3.20±0.40	2.00 <sup>+0.30</sup> <sub>-0.20</sub>	0.20 min.	—
				2.30 <sup>+0.30</sup> <sub>-0.20</sub>		
				2.50±0.30		
9	CGA9 (CC2220)	5.70 <sup>+0.50</sup> <sub>-0.40</sub>	5.00±0.40	2.30 <sup>+0.30</sup> <sub>-0.20</sub>	0.20 min.	—
				2.50±0.30		

\*As for each item, please refer to detail page on TDK web.

## (3) Thickness

Symbol	Dimension(mm)	Symbol	Dimension(mm)
B	0.50	K	1.30
C	0.60	L	1.60
E	0.80	M	2.00
F	0.85	N	2.30
H	1.15	P	2.50
J	1.25		

## (4) Voltage condition in the life test

\* Details are shown in table1 No.16 at 7.PERFORMANCE.

Symbol	Condition
1	Rated Voltage
2	Rated Voltage x 2
3	Rated Voltage x 1.5
4	Rated Voltage x 1.2

## (5) Temperature Characteristics

\* Details are shown in table 1 No.6 and No.7 at 7.PERFORMANCE.

## (6) Rated Voltage

Symbol	Rated Voltage	Symbol	Rated Voltage
2 J	DC 630 V	1 V	DC 35 V
2 W	DC 450 V	1 E	DC 25 V
2 E	DC 250 V	1 C	DC 16 V
2 A	DC 100 V	1 A	DC 10 V
1 H	DC 50 V	0 J	DC 6.3 V

## (7) Rated Capacitance

(Example)

Stated in three digits and in units of pico farads (pF).  
The first and Second digits identify the first and second significant figures of the capacitance, the third digit identifies the multiplier.  
R is designated for a decimal point.

Symbol	Rated Capacitance
2R2	2.2 pF
104	100,000 pF

## (8) Capacitance tolerance

\* M tolerance shall be standard for over 10uF.

Symbol	Tolerance	Capacitance
C	± 0.25 pF	10pF and under
D	± 0.5 pF	
J	± 5 %	Over 10pF
K	± 10 %	
*M	± 20 %	

## (9) Packaging

\* CGA2 type is applicable to tape packaging only.

Symbol	Packaging
B	Bulk
T	Taping

## (10) TDK internal code

※※※ S

S : Soft termination

These TDK internal codes are subject to change without notice.

## 2. COMBINATION OF RATED CAPACITANCE AND TOLERANCE

Class	Temperature Characteristics	Capacitance tolerance		Rated capacitance
1	C0G NP0	10pF and under	C ( $\pm 0.25\text{pF}$ )	1, 1.5, 2, 2.2, 3, 3.3, 4, 4.7, 5
			D ( $\pm 0.5\text{pF}$ )	6, 6.8, 7, 8, 9, 10
		12pF to 10,000pF	J ( $\pm 5\%$ )	E – 12 series
		Over 10,000pF		E – 6 series
2	X7R X7S X7T X8R X8L	0.1 $\mu\text{F}$ and under	K ( $\pm 10\%$ )	E – 3 series or
		Over 0.1 $\mu\text{F}$	K ( $\pm 10\%$ ) M ( $\pm 20\%$ )	E – 6 series

### Capacitance Step in E series

E series	Capacitance Step											
E-3	1.0				2.2				4.7			
E-6	1.0	1.5	2.2	3.3	4.7	6.8						
E-12	1.0	1.2	1.5	1.8	2.2	2.7	3.3	3.9	4.7	5.6	6.8	8.2

## 3. OPERATING TEMPERATURE RANGE

T.C.	Min. operating Temperature	Max. operating Temperature	Reference Temperature
C0G	-55°C	125°C	25°C
NP0	-55°C	150°C	25°C
X7R/X7S/X7T	-55°C	125°C	25°C
X8R/X8L	-55°C	150°C	25°C

## 4. STORING CONDITION AND TERM

Storing temperature	Storing humidity	Storing term
5~40°C	20~70%RH	Within 6 months upon receipt.

## 5. P.C. BOARD

When mounting on an aluminum substrate, the capacitors are more likely to be affected by heat stress from the substrate.

Please inquire separate specification for the large case sizes when mounted on the substrate.

## 6. INDUSTRIAL WASTE DISPOSAL

Dispose this product as industrial waste in accordance with the Industrial Waste Law.

## 7. PERFORMANCE

Table 1

No.	Item	Performance	Test or inspection method																	
1	External Appearance	No defects which may affect performance.	Inspect with magnifying glass (3×)																	
2	Insulation Resistance	10,000MΩ or 500MΩ·μF min. (As for the capacitors of rated voltage 16V DC and lower, 10,000 MΩ or 100MΩ·μF min.), whichever smaller.	Measuring voltage : Rated voltage (As for the capacitor of rated voltage 630V DC, apply 500V DC.) Voltage application time : 60s.																	
3	Voltage Proof	Withstand test voltage without insulation breakdown or other damage.	<table border="1"> <thead> <tr> <th>Class</th> <th>Rated voltage(RV)</th> <th>Apply voltage</th> </tr> </thead> <tbody> <tr> <td rowspan="3">1</td> <td><math>RV \leq 100V</math></td> <td>3 × rated voltage</td> </tr> <tr> <td><math>100V &lt; RV \leq 500V</math></td> <td>1.5 × rated voltage</td> </tr> <tr> <td><math>500V &lt; RV</math></td> <td>1.3 × rated voltage</td> </tr> <tr> <td rowspan="3">2</td> <td><math>RV \leq 100V</math></td> <td>2.5 × rated voltage</td> </tr> <tr> <td><math>100V &lt; RV \leq 500V</math></td> <td>1.5 × rated voltage</td> </tr> <tr> <td><math>500V &lt; RV</math></td> <td>1.3 × rated voltage</td> </tr> </tbody> </table> <p>Voltage application time : 1s. Charge / discharge current : 50mA or lower</p>	Class	Rated voltage(RV)	Apply voltage	1	$RV \leq 100V$	3 × rated voltage	$100V < RV \leq 500V$	1.5 × rated voltage	$500V < RV$	1.3 × rated voltage	2	$RV \leq 100V$	2.5 × rated voltage	$100V < RV \leq 500V$	1.5 × rated voltage	$500V < RV$	1.3 × rated voltage
Class	Rated voltage(RV)	Apply voltage																		
1	$RV \leq 100V$	3 × rated voltage																		
	$100V < RV \leq 500V$	1.5 × rated voltage																		
	$500V < RV$	1.3 × rated voltage																		
2	$RV \leq 100V$	2.5 × rated voltage																		
	$100V < RV \leq 500V$	1.5 × rated voltage																		
	$500V < RV$	1.3 × rated voltage																		
4	Capacitance	Within the specified tolerance.	<p>《 Class 1 》</p> <table border="1"> <thead> <tr> <th>Capacitance</th> <th>Measuring frequency</th> <th>Measuring voltage</th> </tr> </thead> <tbody> <tr> <td>1000pF and under</td> <td>1MHz±10%</td> <td rowspan="2">0.5 ~ 5 Vrms.</td> </tr> <tr> <td>Over 1000pF</td> <td>1kHz±10%</td> </tr> </tbody> </table> <p>《 Class 2 》</p> <table border="1"> <thead> <tr> <th>Capacitance</th> <th>Measuring frequency</th> <th>Measuring voltage</th> </tr> </thead> <tbody> <tr> <td>10uF and under</td> <td>1kHz±10%</td> <td>1.0±0.2Vrms</td> </tr> <tr> <td>Over 10uF</td> <td>120Hz±20%</td> <td>0.5±0.2Vrms.</td> </tr> </tbody> </table> <p>As for the capacitors of rated voltage 6.3V DC, 0.5Vrms is applied.</p>	Capacitance	Measuring frequency	Measuring voltage	1000pF and under	1MHz±10%	0.5 ~ 5 Vrms.	Over 1000pF	1kHz±10%	Capacitance	Measuring frequency	Measuring voltage	10uF and under	1kHz±10%	1.0±0.2Vrms	Over 10uF	120Hz±20%	0.5±0.2Vrms.
Capacitance	Measuring frequency	Measuring voltage																		
1000pF and under	1MHz±10%	0.5 ~ 5 Vrms.																		
Over 1000pF	1kHz±10%																			
Capacitance	Measuring frequency	Measuring voltage																		
10uF and under	1kHz±10%	1.0±0.2Vrms																		
Over 10uF	120Hz±20%	0.5±0.2Vrms.																		
5	Q	Class1	Please refer to detail page on TDK web.																	
	Dissipation Factor	Class2																		
6	Temperature Characteristics of Capacitance (Class1)	<table border="1"> <thead> <tr> <th>T.C.</th> <th>Temperature Coefficient (ppm/°C)</th> </tr> </thead> <tbody> <tr> <td>C0G</td> <td>0 ± 30</td> </tr> <tr> <td>NP0</td> <td>0 ± 30</td> </tr> </tbody> </table> <table border="1"> <tbody> <tr> <td>Capacitance drift</td> <td>Within ± 0.2% or ± 0.05pF, whichever larger.</td> </tr> </tbody> </table>	T.C.	Temperature Coefficient (ppm/°C)	C0G	0 ± 30	NP0	0 ± 30	Capacitance drift	Within ± 0.2% or ± 0.05pF, whichever larger.	<p>Temperature coefficient shall be calculated based on values at 25°C and 85°C temperature.</p> <p>Measuring temperature below 25°C shall be -10°C and -25°C.</p>									
T.C.	Temperature Coefficient (ppm/°C)																			
C0G	0 ± 30																			
NP0	0 ± 30																			
Capacitance drift	Within ± 0.2% or ± 0.05pF, whichever larger.																			

(continued)

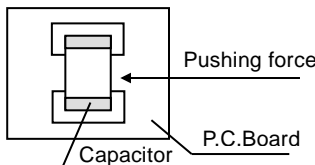
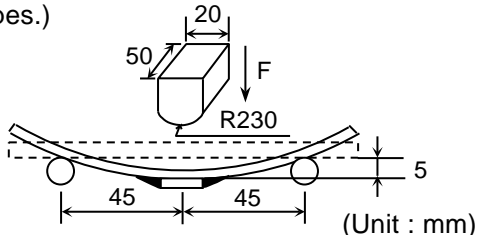
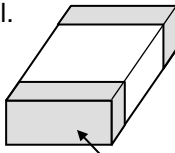
No.	Item	Performance	Test or inspection method										
7	Temperature Characteristics of Capacitance (Class2)	<p style="text-align: center;">Capacitance Change (%)</p> <hr/> <p style="text-align: center;">No voltage applied</p> <hr/> <p style="text-align: center;">X7R : ± 15 X7S : ± 22 X7T : +22           -33 X8R : ± 15 X8L : +15           -40</p> <hr/>	<p>Capacitance shall be measured by the steps shown in the following table after thermal equilibrium is obtained for each step. <math>\Delta C</math> be calculated ref. STEP3 reading</p> <table border="1" data-bbox="975 344 1442 607"> <thead> <tr> <th>Step</th> <th>Temperature(°C)</th> </tr> </thead> <tbody> <tr> <td>1</td> <td>Reference temp. ± 2</td> </tr> <tr> <td>2</td> <td>Min. operating temp. ± 2</td> </tr> <tr> <td>3</td> <td>Reference temp. ± 2</td> </tr> <tr> <td>4</td> <td>Max. operating temp. ± 2</td> </tr> </tbody> </table> <p>As for Min./ Max. operating temp. and Reference temp., please refer to "3.OPERATING TEMPERATURE RANGE". As for measuring voltage, please contact with our sales representative.</p>	Step	Temperature(°C)	1	Reference temp. ± 2	2	Min. operating temp. ± 2	3	Reference temp. ± 2	4	Max. operating temp. ± 2
Step	Temperature(°C)												
1	Reference temp. ± 2												
2	Min. operating temp. ± 2												
3	Reference temp. ± 2												
4	Max. operating temp. ± 2												
8	Robustness of Terminations	No sign of termination coming off, breakage of ceramic, or other abnormal signs.	<p>Reflow solder the capacitors on a P.C.Board shown in Appendix 2. Apply a pushing force gradually at the center of a specimen in a horizontal direction of P.C.board. Pushing force : 17.7N (2N is applied for CGA2 type.) Holding time : 10±1s.</p> 										
9	Bending	No mechanical damage.	<p>Reflow solder the capacitors on a P.C.Board shown in Appendix 1. (2mm is applied for CGA8 and CGA9 types.)</p>  <p style="text-align: right;">(Unit : mm)</p>										
10	Solderability	<p>New solder to cover over 75% of termination. 25% may have pin holes or rough spots but not concentrated in one spot. Ceramic surface of A sections shall not be exposed due to melting or shifting of termination material.</p>  <p style="text-align: center;">A section</p>	<p>Solder : Sn-3.0Ag-0.5Cu</p> <p>Flux : Isopropyl alcohol (JIS K 8839) Rosin (JIS K 5902) 25% solid solution.</p> <p>Solder temp. : 245±5°C</p> <p>Dwell time : 3±0.3s.</p> <p>Solder position : Until both terminations are completely soaked.</p>										

(continued)

No.	Item	Performance	Test or inspection method		
11	Resistance to solder heat	External appearance	No cracks are allowed and terminations shall be covered at least 60% with new solder.		
		Capacitance	Characteristics	Change from the value before test	
			Class1	C0G NP0	$\pm 2.5\%$ or $\pm 0.25\text{pF}$ , whichever larger.
			Class2	X7R X7S X7T X8R X8L	$\pm 7.5\%$
		Q (Class1)	Meet the initial spec.	Solder : Sn-3.0Ag-0.5Cu Flux : Isopropyl alcohol (JIS K 8839) Rosin (JIS K 5902) 25% solid solution. Solder temp. : $260\pm 5^\circ\text{C}$ Dwell time : $10\pm 1\text{s}$ . Solder position : Until both terminations are completely soaked. Pre-heating : Temp. — $110\sim 140^\circ\text{C}$ Time — $30\sim 60\text{s}$ . Leave the capacitors in ambient condition for Class 1 : 6~24h Class 2 : $24\pm 2\text{h}$ before measurement.	
		D.F. (Class2)	Meet the initial spec.		
Insulation Resistance	Meet the initial spec.				
Voltage proof	No insulation breakdown or other damage.				
12	Vibration	External appearance	No mechanical damage.		
		Capacitance	Characteristics	Change from the value before test	
			Class1	C0G NP0	$\pm 2.5\%$ or $\pm 0.25\text{pF}$ , whichever larger.
			Class2	X7R X7S X7T X8R X8L	$\pm 7.5\%$
Q (Class1)	Meet the initial spec.	Applied force : 5G max. Frequency : 10~2,000Hz Reciprocating sweep time : 20 min. Cycle : 12 cycles in each 3 mutually perpendicular directions. Reflow solder the capacitors on a P.C.Board shown in Appendix 2 before testing.			
D.F. (Class2)	Meet the initial spec.				



(continued)

No.	Item		Performance	Test or inspection method															
13	Temperature cycle	External appearance	No mechanical damage.	<p>Expose the capacitors in the condition step1 through step 4 listed in the following table.</p> <p>Temp. cycle : 1,000 cycles</p> <table border="1"> <thead> <tr> <th>Step</th> <th>Temperature(°C)</th> <th>Time (min.)</th> </tr> </thead> <tbody> <tr> <td>1</td> <td>Min. operating temp. <math>\pm 3</math></td> <td><math>30 \pm 3</math></td> </tr> <tr> <td>2</td> <td>Ambient Temp.</td> <td>2 ~ 5</td> </tr> <tr> <td>3</td> <td>Max. operating temp. <math>\pm 2</math></td> <td><math>30 \pm 2</math></td> </tr> <tr> <td>4</td> <td>Ambient Temp.</td> <td>2 ~ 5</td> </tr> </tbody> </table> <p>As for Min./ Max. operating temp., please refer to "3.OPERATING TEMPERATURE RANGE".</p> <p>Leave the capacitors in ambient condition for Class 1 : 6~24h Class 2 : 24<math>\pm</math>2h before measurement.</p> <p>Reflow solder the capacitors on a P.C.Board shown in Appendix 2 before testing.</p>	Step	Temperature(°C)	Time (min.)	1	Min. operating temp. $\pm 3$	$30 \pm 3$	2	Ambient Temp.	2 ~ 5	3	Max. operating temp. $\pm 2$	$30 \pm 2$	4	Ambient Temp.	2 ~ 5
		Step	Temperature(°C)		Time (min.)														
		1	Min. operating temp. $\pm 3$		$30 \pm 3$														
		2	Ambient Temp.		2 ~ 5														
		3	Max. operating temp. $\pm 2$		$30 \pm 2$														
		4	Ambient Temp.		2 ~ 5														
Capacitance	Characteristics		Change from the value before test																
	Class1	C0G NP0	Please contact with our sales representative.																
Class2	X7R X7S X7T X8R X8L																		
Q (Class1)	Meet the initial spec.																		
D.F. (Class2)	Meet the initial spec.																		
Insulation Resistance	Meet the initial spec.																		
Voltage proof	No insulation breakdown or other damage.																		
14	Moisture Resistance (Steady State)	External appearance	No mechanical damage.	<p>Test temp. : 40<math>\pm</math>2°C Test humidity : 90~95%RH</p> <p>Test time : 500 +24,0h</p> <p>Leave the capacitors in ambient condition for Class 1 : 6~24h Class 2 : 24<math>\pm</math>2h before measurement.</p> <p>Reflow solder the capacitors on a P.C.Board shown in Appendix2 before testing.</p>															
		Capacitance	Characteristics		Change from the value before test														
			Class1		C0G NP0	Please contact with our sales representative.													
		Class2	X7R X7S X7T X8R X8L																
		Q (Class1)	Capacitance		Q														
			30pF and over		350 min.														
10pF and over under 30pF	275+5/2xC min.																		
Under 10pF	200+10xC min.																		
C : Rated capacitance (pF)																			
D.F. (Class2)	200% of initial spec. max.																		
Insulation Resistance	1,000M $\Omega$ or 50M $\Omega$ · $\mu$ F min. (As for the capacitors of rated voltage 16V DC and lower, 1,000 M $\Omega$ or 10M $\Omega$ · $\mu$ F min.), whichever smaller.																		

(continued)

No.	Item	Performance	Test or inspection method									
15	Moisture Resistance	External appearance	Test temp. : 85±2°C Test humidity : 85%RH Applied voltage : Rated voltage Test time : 1,000 +48,0h  Charge/discharge current : 50mA or lower  Leave the capacitors in ambient condition for Class 1 : 6~24h Class 2 : 24±2h before measurement.  Reflow solder the capacitors on a P.C.Board shown in Appendix2 before testing.  Initial value setting (only for class 2) Voltage conditioning «After voltage treat the capacitors under testing temperature and voltage for 1 hour,» leave the capacitors in ambient condition for 24±2h before measurement. Use this measurement for initial value.									
		Capacitance		<table border="1"> <tr> <td colspan="2">Characteristics</td> <td rowspan="2">Change from the value before test</td> </tr> <tr> <td>Class1</td> <td>C0G NP0</td> </tr> <tr> <td>Class2</td> <td>X7R X7S X7T X8R X8L</td> <td rowspan="2">Please contact with our sales representative.</td> </tr> </table>	Characteristics		Change from the value before test	Class1	C0G NP0	Class2	X7R X7S X7T X8R X8L	Please contact with our sales representative.
				Characteristics		Change from the value before test						
		Class1		C0G NP0								
		Class2		X7R X7S X7T X8R X8L	Please contact with our sales representative.							
Q (Class1)	<table border="1"> <tr> <td>Capacitance</td> <td>Q</td> </tr> <tr> <td>30pF and over</td> <td>200 min.</td> </tr> <tr> <td>Under 30pF</td> <td>100+10/3×C min.</td> </tr> </table> C : Rated capacitance (pF)	Capacitance	Q	30pF and over		200 min.	Under 30pF	100+10/3×C min.				
	Capacitance	Q										
	30pF and over	200 min.										
Under 30pF	100+10/3×C min.											
D.F. (Class2)	200% of initial spec. max.											
Insulation Resistance	500MΩ or 25MΩ·μF min. (As for the capacitors of rated voltage 16V DC and lower, 500 MΩ or 5MΩ·μF min.), whichever smaller.											
16	Life	External appearance	Test temp. : Maximum operating temperature±2°C Applied voltage : Please contact with our sales representative.  Test time : 1,000 +48,0h  Charge/discharge current : 50mA or lower  Leave the capacitors in ambient condition for Class 1 : 6~24h Class 2 : 24±2h before measurement.  Reflow solder the capacitors on a P.C.Board shown in Appendix2 before testing.  Initial value setting (only for class 2) Voltage conditioning «After voltage treat the capacitors under testing temperature and voltage for 1 hour,» leave the capacitors in ambient condition for 24±2h before measurement. Use this measurement for initial value.									
		Capacitance		<table border="1"> <tr> <td colspan="2">Characteristics</td> <td rowspan="2">Change from the value before test</td> </tr> <tr> <td>Class1</td> <td>C0G NP0</td> </tr> <tr> <td>Class2</td> <td>X7R X7S X7T X8R X8L</td> <td rowspan="2">Please contact with our sales representative.</td> </tr> </table>	Characteristics		Change from the value before test	Class1	C0G NP0	Class2	X7R X7S X7T X8R X8L	Please contact with our sales representative.
				Characteristics		Change from the value before test						
		Class1		C0G NP0								
		Class2		X7R X7S X7T X8R X8L	Please contact with our sales representative.							
Q (Class1)	<table border="1"> <tr> <td>Capacitance</td> <td>Q</td> </tr> <tr> <td>30pF and over</td> <td>350 min.</td> </tr> <tr> <td>10pF and over to under 30pF</td> <td>275+5/2×C min.</td> </tr> <tr> <td>Under 10pF</td> <td>200+10×C min.</td> </tr> </table> C : Rated capacitance (pF)	Capacitance	Q	30pF and over		350 min.	10pF and over to under 30pF	275+5/2×C min.	Under 10pF	200+10×C min.		
	Capacitance	Q										
	30pF and over	350 min.										
10pF and over to under 30pF	275+5/2×C min.											
Under 10pF	200+10×C min.											
D.F. (Class2)	200% of initial spec. max.											
Insulation Resistance	1,000MΩ or 50MΩ·μF min. (As for the capacitors of rated voltage 16V DC and lower, 1,000 MΩ or 10MΩ·μF min.), whichever smaller.											

\*As for the initial measurement of capacitors (Class2) on number 7,11,12,13 and 14 leave capacitors at 150 0,-10°C for 1 hour and measure the value after leaving capacitors for 24±2h in ambient condition.

### Appendix1 P.C.Board for bending test

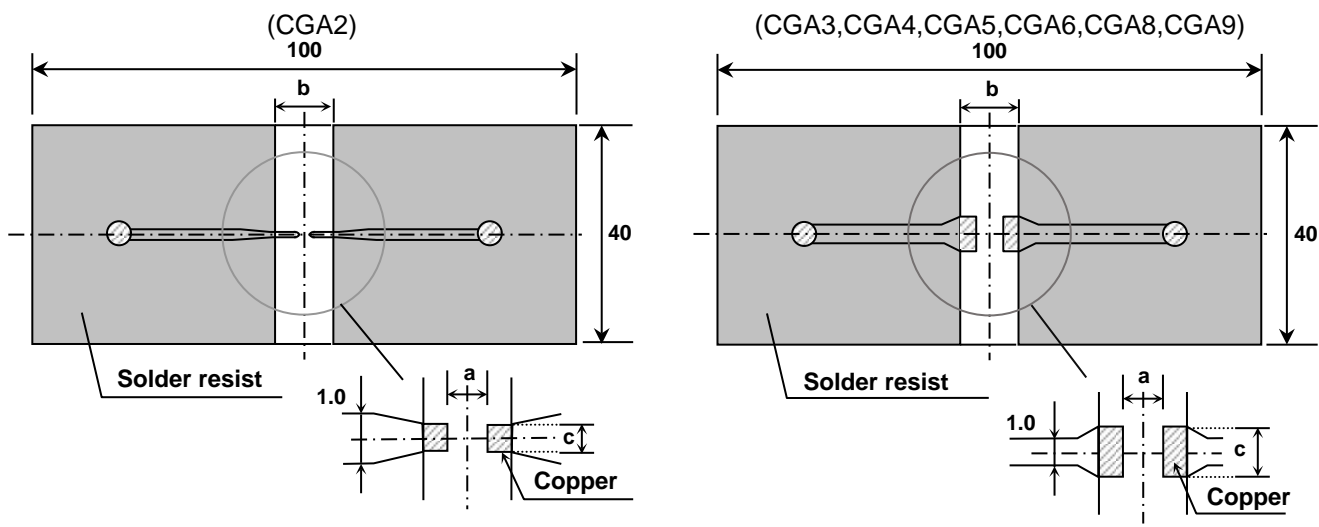

### Appendix2 P.C. Board for reliability test

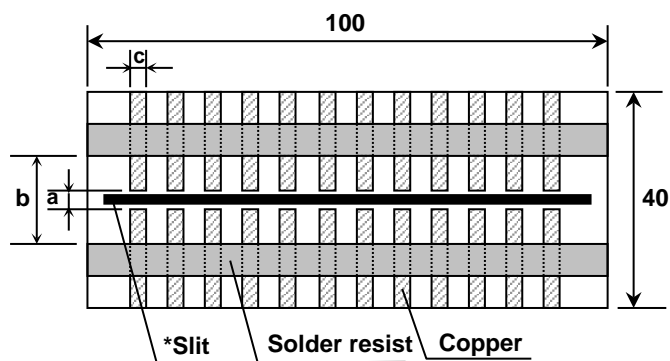

\* It is recommended to provide a slit on P.C.Board for CGA6,CGA8 and CGA9.

(Unit : mm)

Case size	Symbol	Dimensions		
		a	b	c
CGA2 (CC0402)		0.4	1.5	0.5
CGA3 (CC0603)		1.0	3.0	1.2
CGA4 (CC0805)		1.2	4.0	1.65
CGA5 (CC1206)		2.2	5.0	2.0
CGA6 (CC1210)		2.2	5.0	2.9
CGA8 (CC1812)		3.5	7.0	3.7
CGA9 (CC2220)		4.5	8.0	5.6

1. Material : Glass Epoxy(As per JIS C6484 GE4)

2. Thickness : Appendix 1 — 0.8mm (CGA2)  
 — 1.6mm (CGA3,CGA4,CGA5,CGA6,CGA8,CGA9)  
 : Appendix 2 — 1.6mm

Copper(Thickness:0.035mm)  
 Solder resist

## 8. INSIDE STRUCTURE AND MATERIAL

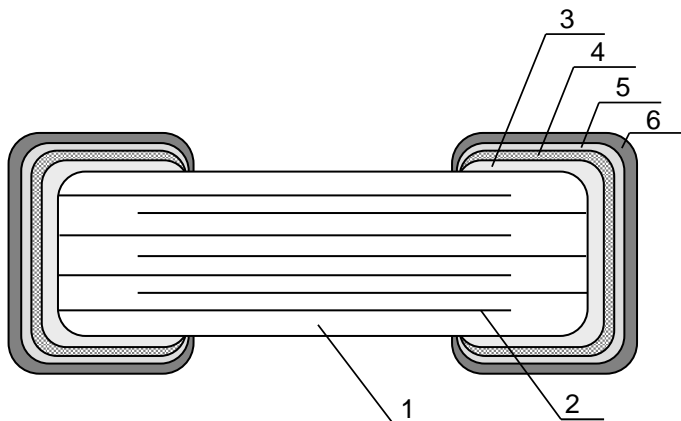

No.	NAME	MATERIAL	
		Class1	Class2
1	Dielectric	CaZrO <sub>3</sub>	BaTiO <sub>3</sub>
2	Electrode	Nickel (Ni)	
3	Termination	Copper (Cu)	
4		Conductive resin (Filler : Ag)	
5		Nickel (Ni)	
6		Tin (Sn)	

## 9. CAUTION FOR PRODUCTS WITH SOFT TERMINATION

This product contains Ag (Silver) as part of the middle layer of termination. To avoid electromigration of Ag under high temperature and humidity, and failures caused by corrosive gas, chip capacitors on P.C boards should be protected by moisture proof-sealing.

## 10. PACKAGING

Packaging shall be done to protect the components from the damage during transportation and storing, and a label which has the following information shall be attached.

10.1 Each plastic bag for bulk packaging contains 1000pcs. And the minimum quantity for Bulk packaging is 1000pcs.

10.2 Tape packaging is as per 14. TAPE PACKAGING SPECIFICATION.

\* CGA2 [CC0402] type is applicable to tape packaging only.

- 1) Inspection No.
- 2) TDK P/N
- 3) Customer's P/N
- 4) Quantity

\*Composition of Inspection No.

Example      F 1 A - 23 - 001  
                   (a) (b) (c)        (d)        (e)

- (a) Line code
- (b) Last digit of the year
- (c) Month and A for January and B for February and so on. (Skip I)
- (d) Inspection Date of the month.
- (e) Serial No. of the day

\*Composition of new Inspection No.

(Implemented on and after May 1, 2019 in sequence)

Example      

I	F	1	E	2	3	A	0	0	1
---	---	---	---	---	---	---	---	---	---

  
                   (a) (b) (c) (d)    (e)    (f)    (g)

- (a) Prefix
- (b) Line code
- (c) Last digit of the year
- (d) Month and A for January and B for February and so on. (Skip I)
- (e) Inspection Date of the month.
- (f) Serial No. of the day(00 ~ ZZ)
- (g) Suffix(00 ~ ZZ)

\* It was shifted to the new inspection No. on and after May 2019, but the implementation timing may be different depending on shipment bases.

Until the shift is completed, either current or new composition of inspection No. will be applied.

## 11. RECOMMENDATION

As for CGA6 [CC1210] and larger, It is recommended to provide a slit (about 1mm width) in the board under the components to improve washing Flux. And please make sure to dry detergent up completely before.

## 12. SOLDERING CONDITION

As for CGA2 [CC0402], CGA6 [CC1210] and larger, reflow soldering only.  
 For other case sizes than the above, reflow soldering is recommended.

### 13. CAUTION

No.	Process	Condition
1	Operating Condition (Storage, Use, Transportation)	<p>1-1. Storage, Use</p> <p>The capacitors must be stored in an ambient temperature of 5 to 40°C with a relative humidity of 20 to 70%RH. JIS C 60721-3-1 Class 1K2 should be followed for the other climatic conditions.</p> <ol style="list-style-type: none"> <li>1) High temperature and humidity environment may affect a capacitor's solder ability because it accelerates terminal oxidization. They also deteriorate performance of taping and packaging. Therefore, SMD capacitors shall be used within 6 months. For capacitors with terminal electrodes consisting of silver or silver-palladium which tend to become oxidized or sulfurized, use as soon as possible, such as within one month after opening the bag.</li> <li>2) When capacitors are stored for a longer time period than 6 months, confirm the solderability of the capacitors prior to use. During storage, keep the minimum packaging unit in its original packaging without opening it. Do not deviate from the above temperature and humidity conditions even for a short term.</li> <li>3) Corrosive gasses in the air or atmosphere may result in deterioration of the reliability, such as poor solderability of the terminal electrodes. Do not store capacitors where they will be exposed to corrosive gas (e.g., hydrogen sulfide, sulfur dioxide, chlorine ammonia etc.)</li> <li>4) Solderability and electrical performance may deteriorate due to photochemical change in the terminal electrode if stored in direct sunlight, or due to condensation from rapid changes in humidity. The capacitors especially which use resin material must be operated and stored in an environment free of dew condensation, as moisture absorption due to condensation may affect the performance.</li> <li>5) Refer to JIS C 60721-3-1, class 1K2 for other climate conditions.</li> </ol> <p>1-2. Handling in transportation</p> <p>In case of the transportation of the capacitors, the performance of the capacitors may be deteriorated depending on the transportation condition. (Refer to JEITA RCR-2335C 9.2 Handling in transportation)</p>
2	Circuit design  Caution	<p>2-1. Operating temperature</p> <ol style="list-style-type: none"> <li>1) Upper category temperature (maximum operating temperature) is specified. It is necessary to select a capacitor whose rated temperature is higher than the operating temperature. Also, it is necessary to consider the temperature distribution in the equipment and seasonal temperature variation.</li> <li>2) Surface temperature including self heating should be below maximum operating temperature. Due to dielectric loss, capacitors will heat itself when AC is applied due to ESR. Especially at high frequencies, please be careful that the heat might be so extreme. Also, even if the surface temperature of the capacitor includes self-heating and is the maximum operating temperature or lower, excessive heating of the capacitor due to self-heating may cause deterioration of the characteristics and reliability of the capacitor. The self-heating temperature rise of the capacitor changes depending on the difference in heat radiation due to the mounting method to the device, the ambient temperature, the cooling method of the device and circuit board material and the design, etc. The load should be contained so that the self-heating temperature rise of the capacitor body in a natural convection environment at an ambient temperature of 25°C remain below 20°C.</li> </ol> <p>When using in a high-frequency circuit or a circuit in which a capacitor generates heat, such as when a high-frequency ripple current flows, pay attention to the above precautions. (Note that accurate measurement may not be possible with self-heating measurement when the equipment applies cooling other than natural convection such as a cooling fan.)</p>

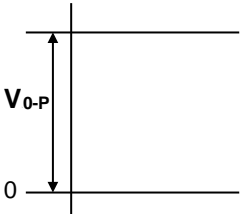
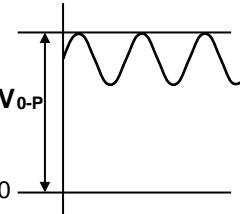
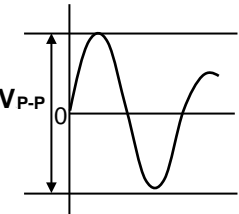
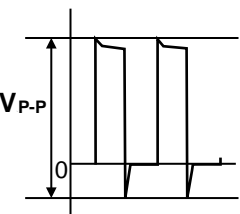
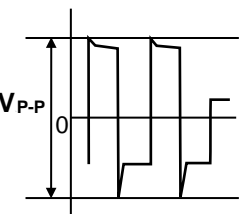
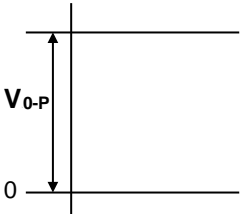
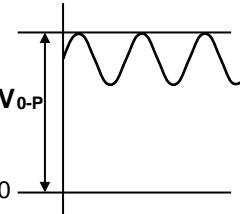
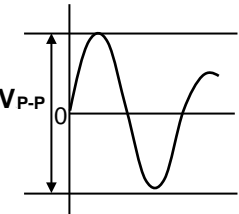
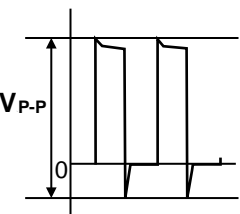
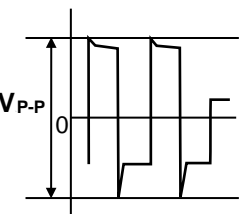
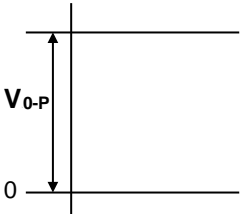
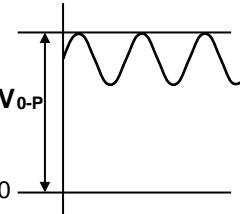
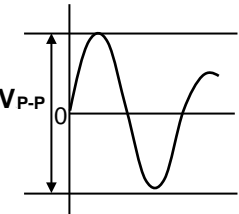
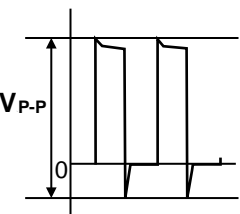
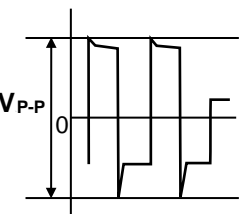
No.	Process	Condition														
2	Circuit design  Caution	<p>3) The electrical characteristics of the capacitors will vary depending on the temperature. The capacitors should be selected and designed in taking the temperature into consideration.</p> <p>2-2. When overvoltage is applied                      Applying overvoltage to a capacitor may cause dielectric breakdown and result in a short circuit. The duration until dielectric breakdown depends on the applied voltage and the ambient temperature.</p> <p>2-3. Operating voltage                      1) Operating voltage across the terminals should be below the rated voltage.                      When AC and DC are super imposed, <math>V_{0-P}</math> must be below the rated voltage. — (1) and (2)                      AC or pulse with overshooting, <math>V_{P-P}</math> must be below the rated voltage. — (3), (4) and (5)                      When the voltage is started to apply to the circuit or it is stopped applying, the irregular voltage may be generated for a transit period because of resonance or switching. Be sure to use the capacitors within rated voltage containing these Irregular voltage.</p> <table border="1" data-bbox="469 757 1444 1025"> <thead> <tr> <th data-bbox="469 757 660 790">Voltage</th> <th data-bbox="660 757 922 790">(1) DC voltage</th> <th data-bbox="922 757 1184 790">(2) DC+AC voltage</th> <th data-bbox="1184 757 1444 790">(3) AC voltage</th> </tr> </thead> <tbody> <tr> <td data-bbox="469 790 660 1025">Positional Measurement (Rated voltage)</td> <td data-bbox="660 790 922 1025">  </td> <td data-bbox="922 790 1184 1025">  </td> <td data-bbox="1184 790 1444 1025">  </td> </tr> </tbody> </table> <table border="1" data-bbox="469 1055 1184 1323"> <thead> <tr> <th data-bbox="469 1055 660 1088">Voltage</th> <th data-bbox="660 1055 922 1088">(4) Pulse voltage (A)</th> <th data-bbox="922 1055 1184 1088">(5) Pulse voltage (B)</th> </tr> </thead> <tbody> <tr> <td data-bbox="469 1088 660 1323">Positional Measurement (Rated voltage)</td> <td data-bbox="660 1088 922 1323">  </td> <td data-bbox="922 1088 1184 1323">  </td> </tr> </tbody> </table> <p>2) Even below the rated voltage, if repetitive high frequency AC or pulse is applied, the reliability of the capacitors may be reduced.</p> <p>3) The effective capacitance will vary depending on applied DC and AC voltages. The capacitors should be selected and designed in taking the voltages into consideration.</p> <p>4) Abnormal voltage (surge voltage, static electricity, pulse voltage, etc.) shall not exceed the rated voltage.</p> <p>5) When capacitors are used in a series connection, it is necessary to add a balancing circuit such as voltage dividing resistors in order to avoid an imbalance in the voltage applied to each capacitor.</p> <p>2-4. Frequency                      When the capacitors (Class 2) are used in AC and/or pulse voltages, the capacitors may vibrate themselves and generate audible sound.</p>	Voltage	(1) DC voltage	(2) DC+AC voltage	(3) AC voltage	Positional Measurement (Rated voltage)				Voltage	(4) Pulse voltage (A)	(5) Pulse voltage (B)	Positional Measurement (Rated voltage)		
Voltage	(1) DC voltage	(2) DC+AC voltage	(3) AC voltage													
Positional Measurement (Rated voltage)																
Voltage	(4) Pulse voltage (A)	(5) Pulse voltage (B)														
Positional Measurement (Rated voltage)																

No.	Process	Condition																																																																	
3	Designing P.C.board	<p>The amount of solder at the terminations has a direct effect on the reliability of the capacitors.</p> <ol style="list-style-type: none"> <li>1) The greater the amount of solder, the higher the stress on the chip capacitors, and the more likely that it will break. When designing a P.C.board, determine the shape and size of the solder lands to have proper amount of solder on the terminations.</li> <li>2) Avoid using common solder land for multiple terminations and provide individual solder land for each terminations.</li> <li>3) Size and recommended land dimensions.</li> </ol> <div data-bbox="651 517 1362 801" style="text-align: center;"> </div> <table border="1" data-bbox="464 875 1444 1122"> <caption>Reflow soldering (mm)</caption> <thead> <tr> <th>Case size</th> <th>CGA2 (CC0402)</th> <th>CGA3 (CC0603)</th> <th>CGA4 (CC0805)</th> <th>CGA5 (CC1206)</th> </tr> </thead> <tbody> <tr> <td>Symbol</td> <td></td> <td></td> <td></td> <td></td> </tr> <tr> <td>A</td> <td>0.3 ~ 0.5</td> <td>0.6 ~ 0.8</td> <td>0.9 ~ 1.2</td> <td>2.0 ~ 2.4</td> </tr> <tr> <td>B</td> <td>0.35 ~ 0.45</td> <td>0.6 ~ 0.8</td> <td>0.7 ~ 0.9</td> <td>1.0 ~ 1.2</td> </tr> <tr> <td>C</td> <td>0.4 ~ 0.6</td> <td>0.6 ~ 0.8</td> <td>0.9 ~ 1.2</td> <td>1.1 ~ 1.6</td> </tr> </tbody> </table> <table border="1" data-bbox="464 1160 1249 1379"> <thead> <tr> <th>Case size</th> <th>CGA6 (CC1210)</th> <th>CGA8 (CC1812)</th> <th>CGA9 (CC2220)</th> </tr> </thead> <tbody> <tr> <td>Symbol</td> <td></td> <td></td> <td></td> </tr> <tr> <td>A</td> <td>2.0 ~ 2.4</td> <td>3.1 ~ 3.7</td> <td>4.1 ~ 4.8</td> </tr> <tr> <td>B</td> <td>1.0 ~ 1.2</td> <td>1.2 ~ 1.4</td> <td>1.2 ~ 1.4</td> </tr> <tr> <td>C</td> <td>1.9 ~ 2.5</td> <td>2.4 ~ 3.2</td> <td>4.0 ~ 5.0</td> </tr> </tbody> </table> <table border="1" data-bbox="464 1429 1254 1682"> <caption>Flow soldering (Unrecommend) (mm)</caption> <thead> <tr> <th>Case size</th> <th>CGA3 (CC0603)</th> <th>CGA4 (CC0805)</th> <th>CGA5 (CC1206)</th> </tr> </thead> <tbody> <tr> <td>Symbol</td> <td></td> <td></td> <td></td> </tr> <tr> <td>A</td> <td>0.7 ~ 1.0</td> <td>1.0 ~ 1.3</td> <td>2.1 ~ 2.5</td> </tr> <tr> <td>B</td> <td>0.8 ~ 1.0</td> <td>1.0 ~ 1.2</td> <td>1.1 ~ 1.3</td> </tr> <tr> <td>C</td> <td>0.6 ~ 0.8</td> <td>0.8 ~ 1.1</td> <td>1.0 ~ 1.3</td> </tr> </tbody> </table>	Case size	CGA2 (CC0402)	CGA3 (CC0603)	CGA4 (CC0805)	CGA5 (CC1206)	Symbol					A	0.3 ~ 0.5	0.6 ~ 0.8	0.9 ~ 1.2	2.0 ~ 2.4	B	0.35 ~ 0.45	0.6 ~ 0.8	0.7 ~ 0.9	1.0 ~ 1.2	C	0.4 ~ 0.6	0.6 ~ 0.8	0.9 ~ 1.2	1.1 ~ 1.6	Case size	CGA6 (CC1210)	CGA8 (CC1812)	CGA9 (CC2220)	Symbol				A	2.0 ~ 2.4	3.1 ~ 3.7	4.1 ~ 4.8	B	1.0 ~ 1.2	1.2 ~ 1.4	1.2 ~ 1.4	C	1.9 ~ 2.5	2.4 ~ 3.2	4.0 ~ 5.0	Case size	CGA3 (CC0603)	CGA4 (CC0805)	CGA5 (CC1206)	Symbol				A	0.7 ~ 1.0	1.0 ~ 1.3	2.1 ~ 2.5	B	0.8 ~ 1.0	1.0 ~ 1.2	1.1 ~ 1.3	C	0.6 ~ 0.8	0.8 ~ 1.1	1.0 ~ 1.3
Case size	CGA2 (CC0402)	CGA3 (CC0603)	CGA4 (CC0805)	CGA5 (CC1206)																																																															
Symbol																																																																			
A	0.3 ~ 0.5	0.6 ~ 0.8	0.9 ~ 1.2	2.0 ~ 2.4																																																															
B	0.35 ~ 0.45	0.6 ~ 0.8	0.7 ~ 0.9	1.0 ~ 1.2																																																															
C	0.4 ~ 0.6	0.6 ~ 0.8	0.9 ~ 1.2	1.1 ~ 1.6																																																															
Case size	CGA6 (CC1210)	CGA8 (CC1812)	CGA9 (CC2220)																																																																
Symbol																																																																			
A	2.0 ~ 2.4	3.1 ~ 3.7	4.1 ~ 4.8																																																																
B	1.0 ~ 1.2	1.2 ~ 1.4	1.2 ~ 1.4																																																																
C	1.9 ~ 2.5	2.4 ~ 3.2	4.0 ~ 5.0																																																																
Case size	CGA3 (CC0603)	CGA4 (CC0805)	CGA5 (CC1206)																																																																
Symbol																																																																			
A	0.7 ~ 1.0	1.0 ~ 1.3	2.1 ~ 2.5																																																																
B	0.8 ~ 1.0	1.0 ~ 1.2	1.1 ~ 1.3																																																																
C	0.6 ~ 0.8	0.8 ~ 1.1	1.0 ~ 1.3																																																																

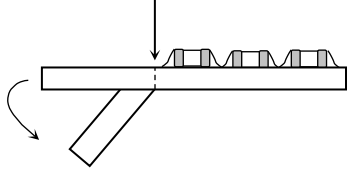
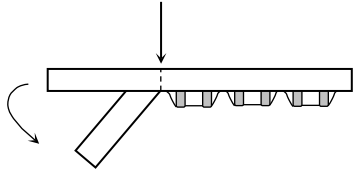
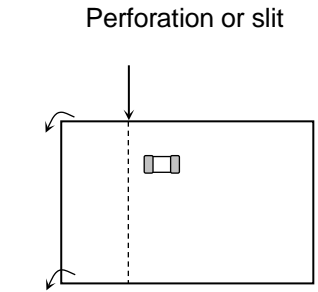
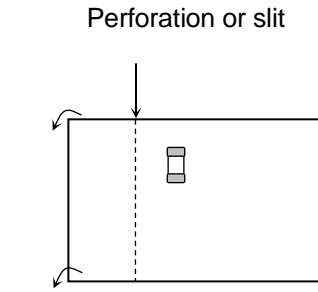
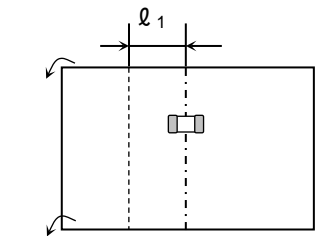
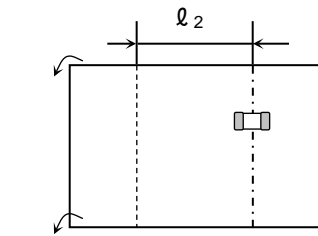

No.	Process	Condition		
3	Designing P.C.board	4) Recommended chip capacitors layout is as following.		
			Disadvantage against bending stress	Advantage against bending stress
Mounting face		<p>Perforation or slit</p>  <p>Break P.C.board with mounted side up.</p>	<p>Perforation or slit</p>  <p>Break P.C.board with mounted side down.</p>	
Chip arrangement (Direction)		<p>Mount perpendicularly to perforation or slit</p> <p>Perforation or slit</p> 	<p>Mount in parallel with perforation or slit</p> <p>Perforation or slit</p> 	
Distance from slit		<p>Closer to slit is higher stress</p>  <p><math>(l_1 &lt; l_2)</math></p>	<p>Away from slit is less stress</p>  <p><math>(l_1 &lt; l_2)</math></p>	

No.	Process	Condition
-----	---------	-----------

3 Designing P.C.board

5) Mechanical stress varies according to location of chip capacitors on the P.C.board.

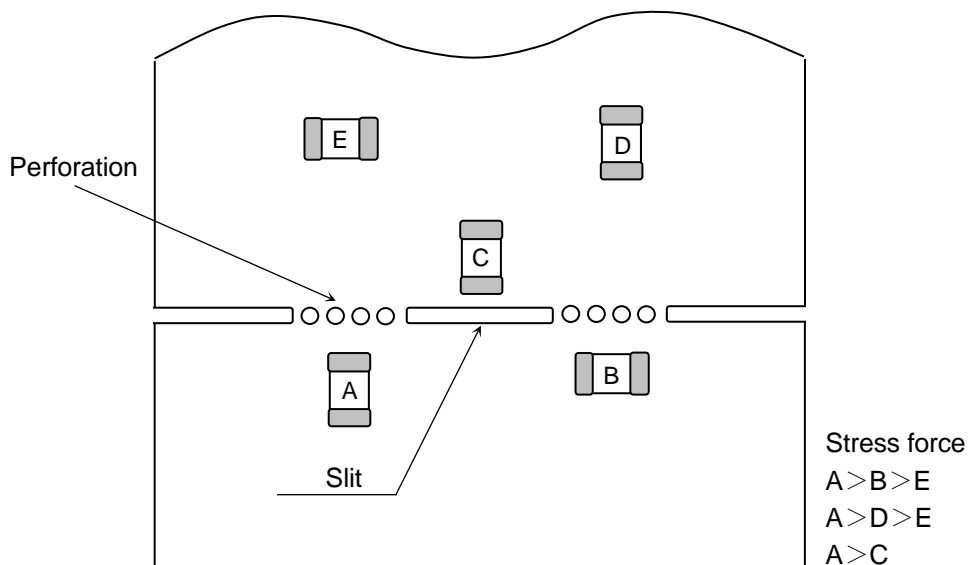

When dividing printed wiring boards, the intensities of mechanical stress applied to capacitors are different according to each dividing method in the order of : Push-back < Slit < V-groove < Perforation. Therefore consider not only position of capacitors, but also the way of the dividing the printed wiring boards.

6) Layout recommendation

Example	Use of common solder land	Soldering with chassis	Use of common solder land with other SMD
Need to avoid	<p>Labels: Chip, Lead wire, Solder, PCB, Adhesive, Solder land</p>	<p>Labels: Chassis, Excessive solder, <math>l_1</math></p>	<p>Labels: Solder land, Excessive solder, Missing solder</p>
Recommendation	<p>Labels: Solder resist, Lead wire, Solder land</p>	<p>Labels: Solder resist, <math>l_2</math></p> <p><math>l_2 &gt; l_1</math></p>	<p>Labels: Solder resist</p>

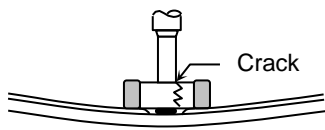
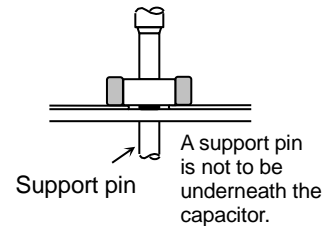
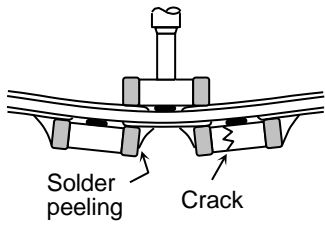
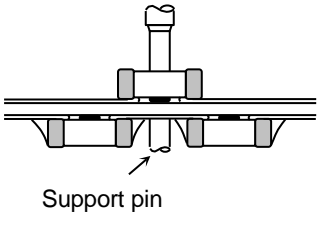
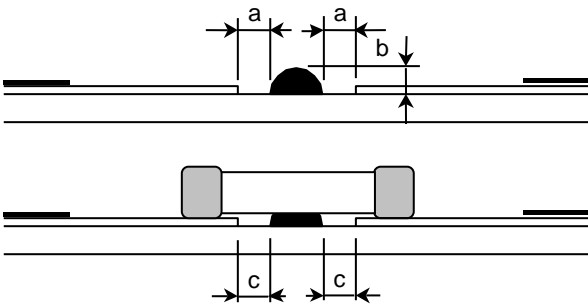
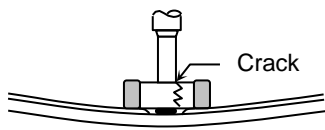
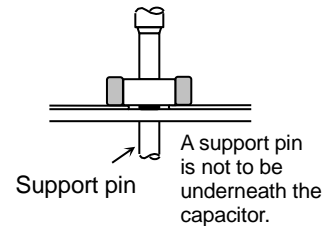
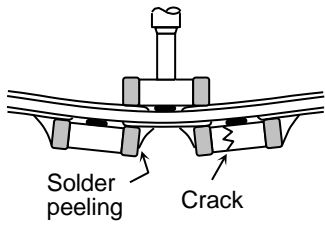
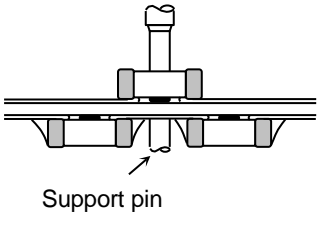
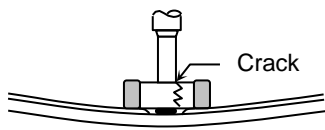
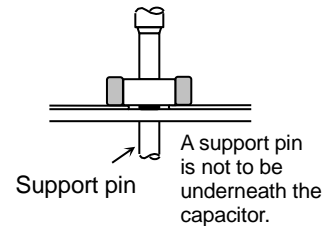
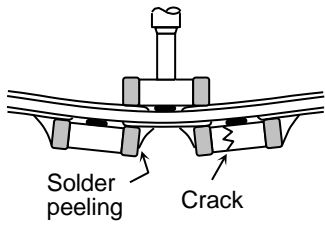
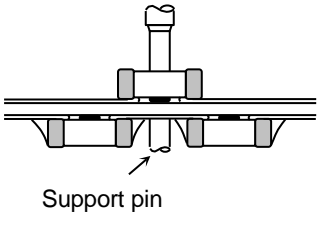
No.	Process	Condition																	
4	Mounting	<p>4-1. Stress from mounting head</p> <p>If the mounting head is adjusted too low, it may induce excessive stress in the chip capacitors to result in cracking. Please take following precautions.</p> <ol style="list-style-type: none"> <li>1) Adjust the bottom dead center of the mounting head to reach on the P.C.board surface and not press it.</li> <li>2) Adjust the mounting head pressure to be 1 to 3N of static weight.</li> <li>3) To minimize the impact energy from mounting head, it is important to provide support from the bottom side of the P.C.board.</li> </ol> <p>See following examples.</p> <table border="1" style="width: 100%; border-collapse: collapse;"> <thead> <tr> <th style="width: 30%;"></th> <th style="width: 35%;">Not recommended</th> <th style="width: 35%;">Recommended</th> </tr> </thead> <tbody> <tr> <td style="text-align: center; vertical-align: middle;">Single-sided mounting</td> <td style="text-align: center;">  </td> <td style="text-align: center;">  <p>A support pin is not to be underneath the capacitor.</p> </td> </tr> <tr> <td style="text-align: center; vertical-align: middle;">Double-sides mounting</td> <td style="text-align: center;">  <p>Solder peeling      Crack</p> </td> <td style="text-align: center;">  <p>Support pin</p> </td> </tr> </tbody> </table> <p>When the centering jaw is worn out, it may give mechanical impact on the capacitors to cause crack. Please control the close up dimension of the centering jaw and provide sufficient preventive maintenance and replacement of it.</p> <p>4-2. Amount of adhesive</p> <div style="text-align: center;">  </div> <table border="1" style="width: 100%; border-collapse: collapse; margin-top: 10px;"> <thead> <tr> <th colspan="2" style="text-align: left;">Example : CGA4 (CC0805), CGA5 (CC1206)</th> </tr> </thead> <tbody> <tr> <td style="text-align: center;">a</td> <td style="text-align: center;">0.2mm min.</td> </tr> <tr> <td style="text-align: center;">b</td> <td style="text-align: center;">70 ~ 100µm</td> </tr> <tr> <td style="text-align: center;">c</td> <td style="text-align: center;">Do not touch the solder land</td> </tr> </tbody> </table>		Not recommended	Recommended	Single-sided mounting		 <p>A support pin is not to be underneath the capacitor.</p>	Double-sides mounting	 <p>Solder peeling      Crack</p>	 <p>Support pin</p>	Example : CGA4 (CC0805), CGA5 (CC1206)		a	0.2mm min.	b	70 ~ 100µm	c	Do not touch the solder land
	Not recommended	Recommended																	
Single-sided mounting		 <p>A support pin is not to be underneath the capacitor.</p>																	
Double-sides mounting	 <p>Solder peeling      Crack</p>	 <p>Support pin</p>																	
Example : CGA4 (CC0805), CGA5 (CC1206)																			
a	0.2mm min.																		
b	70 ~ 100µm																		
c	Do not touch the solder land																		

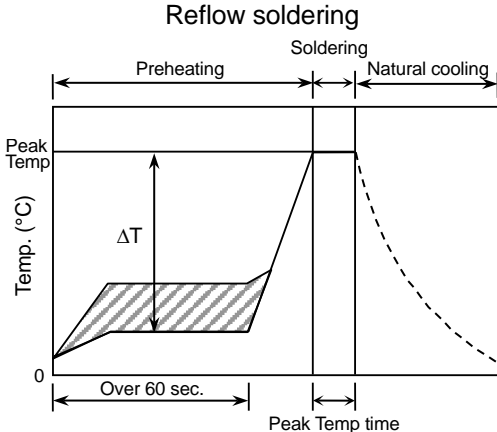
No.	Process	Condition														
5	Soldering	<p>5-1. Flux selection                      Flux can seriously affect the performance of capacitors. Confirm the following to select the appropriate flux.</p> <ol style="list-style-type: none"> <li>1) It is recommended to use a mildly activated rosin flux (less than 0.1wt% chlorine). Strong flux is not recommended.</li> <li>2) Excessive flux must be avoided. Please provide proper amount of flux.</li> <li>3) When water-soluble flux is used, enough washing is necessary.</li> </ol> <p>5-2. Recommended soldering profile : Reflow method                      Refer to the following temperature profile at Reflow soldering.</p> <div style="text-align: center;">  <p style="text-align: center;">Reflow soldering</p> </div> <p>Reflow soldering is recommended for CGA3,CGA4,CGA5 types, but only reflow soldering is allowed for other case sizes.</p> <p>5-3. Recommended soldering peak temp and peak temp duration for Reflow soldering                      Pb free solder is recommended, but if Sn-37Pb must be used, refer to below.</p> <table border="1" style="margin-left: auto; margin-right: auto;"> <thead> <tr> <th rowspan="2" style="text-align: center;">Temp./Duration</th> <th colspan="2" style="text-align: center;">Reflow soldering</th> </tr> <tr> <th style="text-align: center;">Peak temp(°C)</th> <th style="text-align: center;">Duration(sec.)</th> </tr> </thead> <tbody> <tr> <td style="text-align: center;">Solder</td> <td></td> <td></td> </tr> <tr> <td style="text-align: center;">Lead Free Solder</td> <td style="text-align: center;">260 max.</td> <td style="text-align: center;">10 max.</td> </tr> <tr> <td style="text-align: center;">Sn-Pb Solder</td> <td style="text-align: center;">230 max.</td> <td style="text-align: center;">20 max.</td> </tr> </tbody> </table> <p>Recommended solder compositions                      Lead Free Solder : Sn-3.0Ag-0.5Cu</p>	Temp./Duration	Reflow soldering		Peak temp(°C)	Duration(sec.)	Solder			Lead Free Solder	260 max.	10 max.	Sn-Pb Solder	230 max.	20 max.
Temp./Duration	Reflow soldering															
	Peak temp(°C)	Duration(sec.)														
Solder																
Lead Free Solder	260 max.	10 max.														
Sn-Pb Solder	230 max.	20 max.														

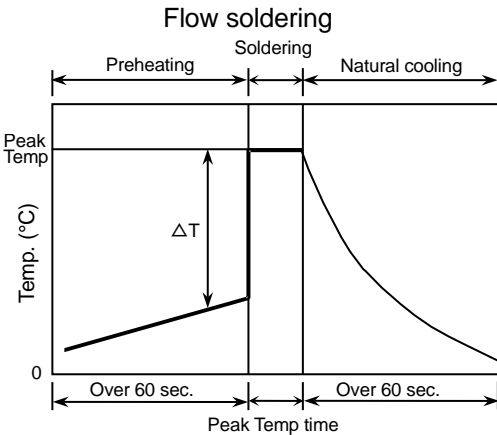
No.	Process	Condition																									
5	Soldering	<p>5-4. Soldering profile : Flow method (Unrecommend) Refer to the following temperature profile at Flow soldering.</p> <div style="text-align: center;">  <p>The graph shows a temperature profile for flow soldering. The y-axis is labeled 'Temp. (°C)' and has a 'Peak Temp' mark and a '0' mark. The x-axis is labeled 'Peak Temp time' and has two 'Over 60 sec.' intervals. The profile is divided into three phases: 'Preheating' (a linear ramp up), 'Soldering' (a constant peak temperature), and 'Natural cooling' (a curve decreasing from the peak). A vertical double-headed arrow labeled 'ΔT' indicates the temperature difference between the peak and the end of the preheating phase.</p> </div> <p>Reflow soldering is recommended for CGA3,CGA4,CGA5 types.</p> <p>5-5. Recommended soldering peak temp and peak temp duration for Flow soldering Pb free solder is recommended, but if Sn-37Pb must be used, refer to below.</p> <table border="1" data-bbox="590 898 1332 1137"> <thead> <tr> <th rowspan="2" style="text-align: center;">Temp./Duration</th> <th colspan="2" style="text-align: center;">Flow soldering</th> </tr> <tr> <th style="text-align: center;">Peak temp(°C)</th> <th style="text-align: center;">Duration(sec.)</th> </tr> </thead> <tbody> <tr> <td style="text-align: center;">Solder</td> <td></td> <td></td> </tr> <tr> <td style="text-align: center;">Lead Free Solder</td> <td style="text-align: center;">260 max.</td> <td style="text-align: center;">5 max.</td> </tr> <tr> <td style="text-align: center;">Sn-Pb Solder</td> <td style="text-align: center;">250 max.</td> <td style="text-align: center;">3 max.</td> </tr> </tbody> </table> <p>Recommended solder compositions Lead Free Solder : Sn-3.0Ag-0.5Cu</p> <p>5-6. Avoiding thermal shock</p> <p>1) Preheating condition</p> <table border="1" data-bbox="528 1328 1412 1630"> <thead> <tr> <th style="text-align: center;">Soldering</th> <th style="text-align: center;">Case size</th> <th style="text-align: center;">Temp. (°C)</th> </tr> </thead> <tbody> <tr> <td rowspan="2" style="text-align: center;">Reflow soldering</td> <td style="text-align: center;">CGA2(CC0402), CGA3(CC0603), CGA4(CC0805), CGA5(CC1206)</td> <td style="text-align: center;"><math>\Delta T \leq 150</math></td> </tr> <tr> <td style="text-align: center;">CGA6(CC1210), CGA8(CC1812), CGA9(CC2220)</td> <td style="text-align: center;"><math>\Delta T \leq 130</math></td> </tr> <tr> <td style="text-align: center;">Flow soldering</td> <td style="text-align: center;">CGA3(CC0603), CGA4(CC0805), CGA5(CC1206)</td> <td style="text-align: center;"><math>\Delta T \leq 150</math></td> </tr> </tbody> </table> <p>2) Cooling condition Natural cooling using air is recommended. If the chips are dipped into a solvent for cleaning, the temperature difference (<math>\Delta T</math>) must be less than 100°C.</p>	Temp./Duration	Flow soldering		Peak temp(°C)	Duration(sec.)	Solder			Lead Free Solder	260 max.	5 max.	Sn-Pb Solder	250 max.	3 max.	Soldering	Case size	Temp. (°C)	Reflow soldering	CGA2(CC0402), CGA3(CC0603), CGA4(CC0805), CGA5(CC1206)	$\Delta T \leq 150$	CGA6(CC1210), CGA8(CC1812), CGA9(CC2220)	$\Delta T \leq 130$	Flow soldering	CGA3(CC0603), CGA4(CC0805), CGA5(CC1206)	$\Delta T \leq 150$
Temp./Duration	Flow soldering																										
	Peak temp(°C)	Duration(sec.)																									
Solder																											
Lead Free Solder	260 max.	5 max.																									
Sn-Pb Solder	250 max.	3 max.																									
Soldering	Case size	Temp. (°C)																									
Reflow soldering	CGA2(CC0402), CGA3(CC0603), CGA4(CC0805), CGA5(CC1206)	$\Delta T \leq 150$																									
	CGA6(CC1210), CGA8(CC1812), CGA9(CC2220)	$\Delta T \leq 130$																									
Flow soldering	CGA3(CC0603), CGA4(CC0805), CGA5(CC1206)	$\Delta T \leq 150$																									

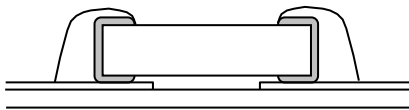
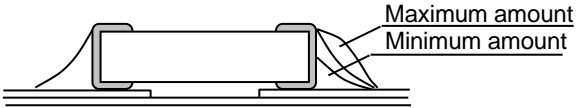
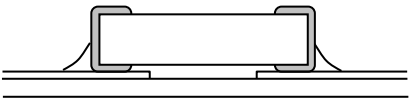
No.	Process	Condition
5	Soldering	<p>5-7. Amount of solder</p> <p>Excessive solder will induce higher tensile force in chip capacitors when temperature changes and it may result in chip cracking. In sufficient solder may detach the capacitors from the P.C.board.</p> <hr/> <div style="display: flex; justify-content: space-between;"> <div data-bbox="496 376 619 439">Excessive solder</div> <div data-bbox="684 353 1094 461">  </div> <div data-bbox="1121 360 1406 454">Higher tensile force in chip capacitors to cause crack</div> </div> <hr/> <div style="display: flex; justify-content: space-between;"> <div data-bbox="496 544 612 573">Adequate</div> <div data-bbox="684 506 1262 613">  </div> </div> <hr/> <div style="display: flex; justify-content: space-between;"> <div data-bbox="496 680 627 743">Insufficient solder</div> <div data-bbox="684 658 1094 766">  </div> <div data-bbox="1121 651 1406 775">Low robustness may cause contact failure or chip capacitors come off the P.C.board.</div> </div> <hr/> <p>5-8. Sn-Zn solder</p> <p>Sn-Zn solder affects product reliability. Please contact TDK in advance when utilize Sn-Zn solder.</p> <p>5-9. Countermeasure for tombstone</p> <p>The misalignment between the mounted positions of the capacitors and the land patterns should be minimized. The tombstone phenomenon may occur especially the capacitors are mounted (in longitudinal direction) in the same direction of the reflow soldering. (Refer to JEITA RCR-2335C Annex A (Informative), Recommendations to prevent the tombstone phenomenon.)</p>

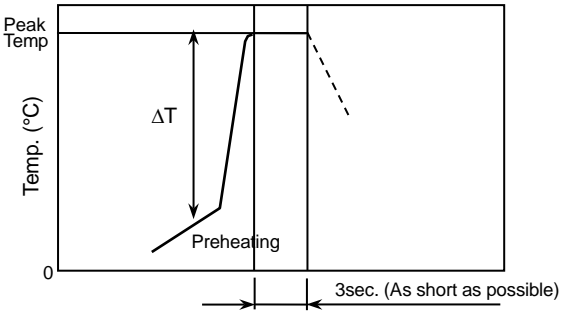
No.	Process	Condition																				
6	Solder repairing	<p>Solder repairing is unavoidable, refer to below.</p> <p>6-1. Solder repair by solder iron</p> <p>1) Selection of the soldering iron tip</p> <p>Tip temperature of solder iron varies by its type, P.C.board material and solder land size. The higher the tip temperature, the quicker the operation. However, heat shock may cause a crack in the chip capacitors.</p> <p>Please make sure the tip temp. before soldering and keep the peak temp and time in accordance with following recommended condition.</p> <div style="text-align: center;"> <p>Manual soldering (Solder iron)</p>  </div> <p style="text-align: center;">Recommended solder iron condition (Sn-Pb Solder and Lead Free Solder)</p> <table border="1" style="width: 100%; border-collapse: collapse;"> <thead> <tr> <th style="width: 20%;">Case size</th> <th style="width: 15%;">Temp. (°C)</th> <th style="width: 15%;">Duration (sec.)</th> <th style="width: 15%;">Wattage (W)</th> <th style="width: 35%;">Shape (mm)</th> </tr> </thead> <tbody> <tr> <td>CGA2(CC0402) CGA3(CC0603) CGA4(CC0805) CGA5(CC1206)</td> <td style="text-align: center;">350 max.</td> <td rowspan="2" style="text-align: center;">3 max.</td> <td rowspan="2" style="text-align: center;">20 max.</td> <td rowspan="2" style="text-align: center;">Ø 3.0 max.</td> </tr> <tr> <td>CGA6(CC1210) CGA8(CC1812) CGA9(CC2220)</td> <td style="text-align: center;">280 max.</td> </tr> </tbody> </table> <p>* Please preheat the chip capacitors with the condition in 6-2 to avoid the thermal shock.</p> <p>2) Direct contact of the soldering iron with ceramic dielectric of chip capacitors may cause crack. Do not touch the ceramic dielectric and the terminations by solder iron.</p> <p>3) It is not recommended to reuse dismantled capacitors.</p> <p>6-2. Avoiding thermal shock</p> <p>Preheating condition</p> <table border="1" style="width: 100%; border-collapse: collapse;"> <thead> <tr> <th style="width: 20%;">Soldering</th> <th style="width: 50%;">Case size</th> <th style="width: 30%;">Temp. (°C)</th> </tr> </thead> <tbody> <tr> <td rowspan="2" style="text-align: center;">Manual soldering</td> <td>CGA2(CC0402), CGA3(CC0603), CGA4(CC0805), CGA5(CC1206)</td> <td style="text-align: center;"><math>\Delta T \leq 150</math></td> </tr> <tr> <td>CGA6(CC1210), CGA8(CC1812), CGA9(CC2220)</td> <td style="text-align: center;"><math>\Delta T \leq 130</math></td> </tr> </tbody> </table>	Case size	Temp. (°C)	Duration (sec.)	Wattage (W)	Shape (mm)	CGA2(CC0402) CGA3(CC0603) CGA4(CC0805) CGA5(CC1206)	350 max.	3 max.	20 max.	Ø 3.0 max.	CGA6(CC1210) CGA8(CC1812) CGA9(CC2220)	280 max.	Soldering	Case size	Temp. (°C)	Manual soldering	CGA2(CC0402), CGA3(CC0603), CGA4(CC0805), CGA5(CC1206)	$\Delta T \leq 150$	CGA6(CC1210), CGA8(CC1812), CGA9(CC2220)	$\Delta T \leq 130$
Case size	Temp. (°C)	Duration (sec.)	Wattage (W)	Shape (mm)																		
CGA2(CC0402) CGA3(CC0603) CGA4(CC0805) CGA5(CC1206)	350 max.	3 max.	20 max.	Ø 3.0 max.																		
CGA6(CC1210) CGA8(CC1812) CGA9(CC2220)	280 max.																					
Soldering	Case size	Temp. (°C)																				
Manual soldering	CGA2(CC0402), CGA3(CC0603), CGA4(CC0805), CGA5(CC1206)	$\Delta T \leq 150$																				
	CGA6(CC1210), CGA8(CC1812), CGA9(CC2220)	$\Delta T \leq 130$																				

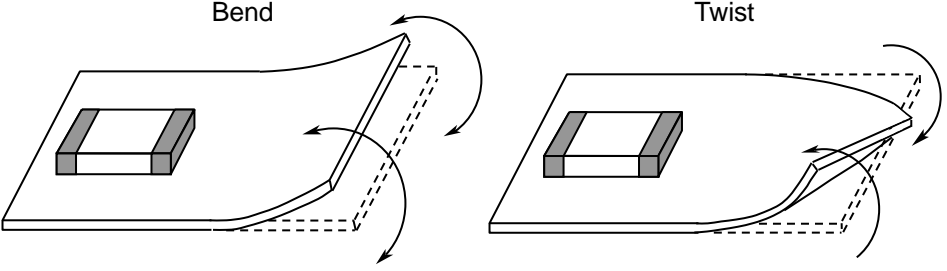
No.	Process	Condition
7	Cleaning	<p>1) If an unsuitable cleaning fluid is used, flux residue or some foreign articles may stick to chip capacitors surface to deteriorate especially the insulation resistance.</p> <p>2) If cleaning condition is not suitable, it may damage the chip capacitors.</p> <p>2)-1. Insufficient washing</p> <p>(1) Terminal electrodes may corrode by Halogen in the flux.</p> <p>(2) Halogen in the flux may adhere on the surface of capacitors, and lower the insulation resistance.</p> <p>(3) Water soluble flux has higher tendency to have above mentioned problems (1) and (2).</p> <p>2)-2. Excessive washing</p> <p>When ultrasonic cleaning equipment is used, excessive ultrasonic power or direct vibration transfer to a printed wiring board may generate a resonant vibration in the board. This may cause a crack in a capacitor or its solder joints to the board and degradation in the terminal strength of the capacitor. In order to avoid this, the following cleaning conditions are recommended.</p> <p style="text-align: center;">Power : 20 W/ℓ max. Frequency : 40 kHz max. Washing time : 5 minutes max.</p> <p>2)-3. If the cleaning fluid is contaminated, density of Halogen increases, and it may bring the same result as insufficient cleaning.</p>
8	Coating and molding of the P.C.board	<p>1) This product contains Ag (Silver) as part of the middle layer of termination. To avoid electromigration of Ag under high temperature and humidity, and failures caused by corrosive gas, chip capacitors on P.C boards should be protected by moisture proof-sealing.</p> <p>2) When the P.C.board is coated, please verify the quality influence on the product.</p> <p>3) Please verify carefully that there is no harmful decomposing or reaction gas emission during curing which may damage the chip capacitors.</p> <p>4) Please verify the curing temperature.</p>
9	Handling after chip mounted ⚠ Caution	<p>1) Please pay attention not to bend or distort the P.C.board after soldering in handling otherwise the chip capacitors may crack.</p> <div style="text-align: center;">  </div>

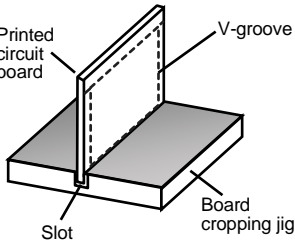
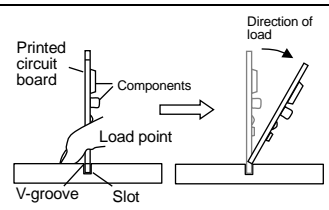
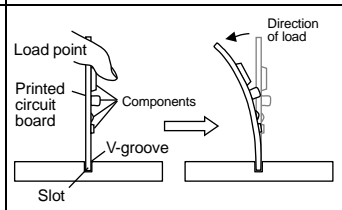
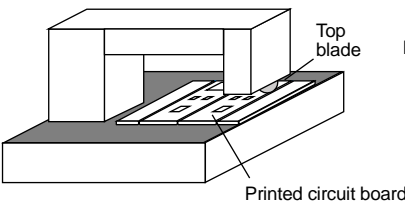
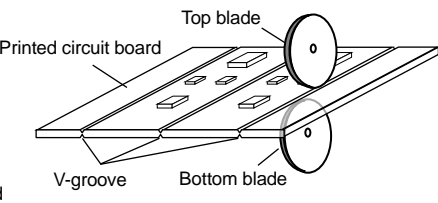
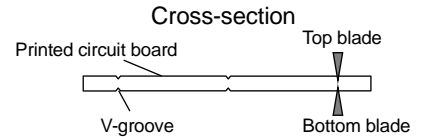
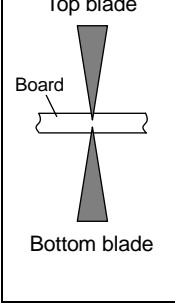
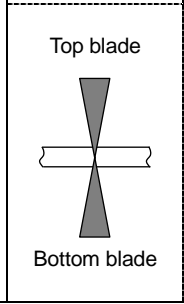
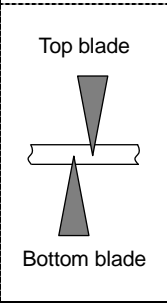
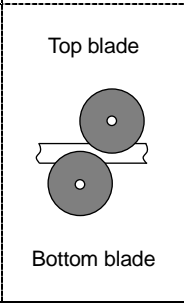
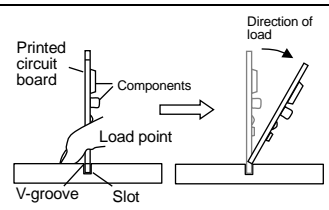
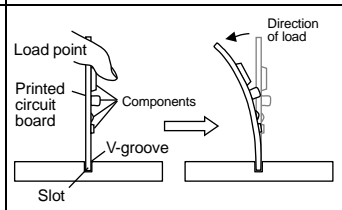
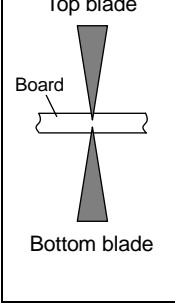
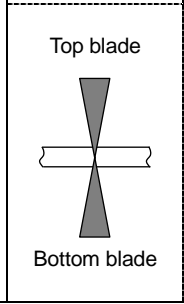
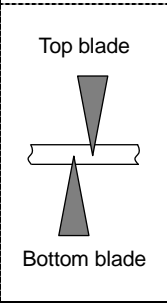
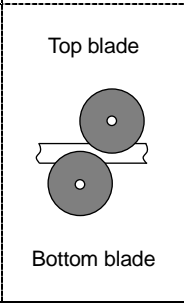
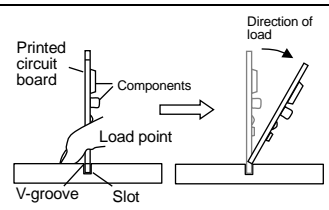
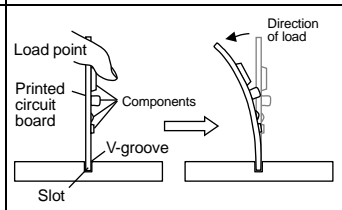
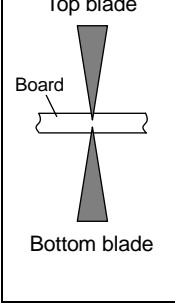
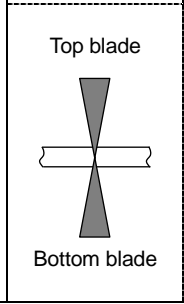
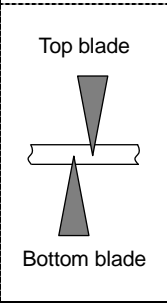
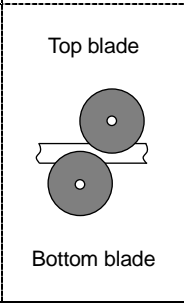

No.	Process	Condition																
9	Handling after chip mounted  Caution	<p>2) Printed circuit board cropping should not be carried out by hand, but by using the proper tooling. Printed circuit board cropping should be carried out using a board cropping jig as shown in the following figure or a board cropping apparatus to prevent inducing mechanical stress on the board.</p> <p>(1) Example of a board cropping jig                      Recommended example: The board should be pushed from the back side, close to the cropping jig so that the board is not bent and the stress applied to the capacitor is compressive.                      Unrecommended example: If the pushing point is far from the cropping jig and the pushing direction is from the front side of the board, large tensile stress is applied to the capacitor, which may cause cracks.</p> <div style="display: flex; justify-content: space-around;"> <div data-bbox="459 584 754 869"> <p>Outline of jig</p>  </div> <div data-bbox="762 577 1441 837"> <table border="1"> <thead> <tr> <th data-bbox="769 586 1098 629">Recommended</th> <th data-bbox="1098 586 1441 629">Unrecommended</th> </tr> </thead> <tbody> <tr> <td data-bbox="769 629 1098 837">  </td> <td data-bbox="1098 629 1441 837">  </td> </tr> </tbody> </table> </div> </div> <p>(2) Example of a board cropping machine</p> <p>An outline of a printed circuit board cropping machine is shown below. The top and bottom blades are aligned with one another along the lines with the V-grooves on printed circuit board when cropping the board.</p> <p>Unrecommended example: Misalignment of blade position between top and bottom, right and left, or front and rear blades may cause a crack in the capacitor.</p> <div style="display: flex; justify-content: space-around;"> <div data-bbox="571 1160 978 1429"> <p>Outline of machine</p>  </div> <div data-bbox="978 1160 1417 1429"> <p>Principle of operation</p>  </div> </div> <div style="text-align: center; margin: 10px 0;"> <p>Cross-section</p>  </div> <table border="1" style="width: 100%; text-align: center;"> <thead> <tr> <th data-bbox="643 1641 818 1686">Recommended</th> <th colspan="3" data-bbox="818 1641 1353 1686">Unrecommended</th> </tr> <tr> <th data-bbox="643 1686 818 1765"></th> <th data-bbox="818 1686 1002 1765">Top-bottom misalignment</th> <th data-bbox="1002 1686 1169 1765">Left-right misalignment</th> <th data-bbox="1169 1686 1353 1765">Front-rear misalignment</th> </tr> </thead> <tbody> <tr> <td data-bbox="643 1765 818 2067">  </td> <td data-bbox="818 1765 1002 2067">  </td> <td data-bbox="1002 1765 1169 2067">  </td> <td data-bbox="1169 1765 1353 2067">  </td> </tr> </tbody> </table>	Recommended	Unrecommended			Recommended	Unrecommended				Top-bottom misalignment	Left-right misalignment	Front-rear misalignment				
Recommended	Unrecommended																	
																		
Recommended	Unrecommended																	
	Top-bottom misalignment	Left-right misalignment	Front-rear misalignment															
																		

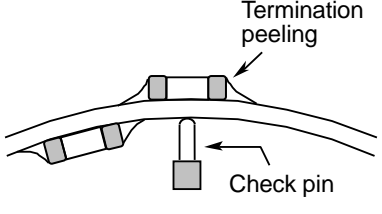
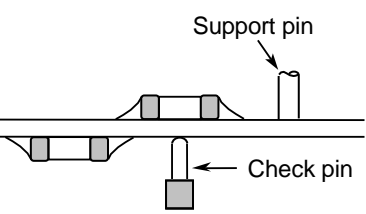
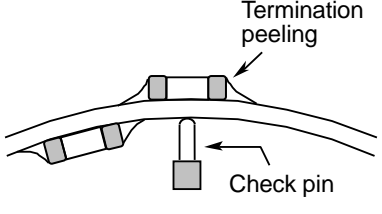
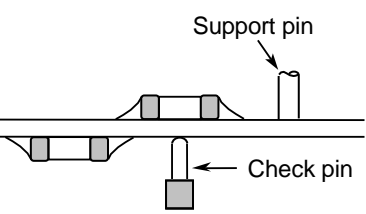
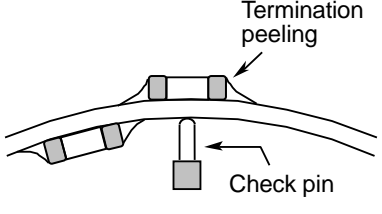
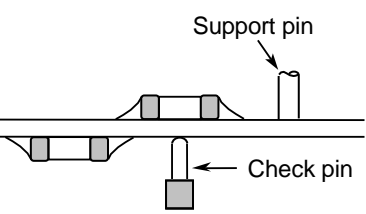
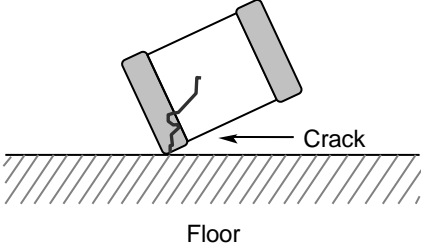
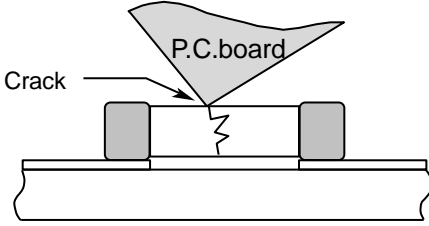
No.	Process	Condition						
9	Handling after chip mounted  Caution	<p>3) When functional check of the P.C.board is performed, check pin pressure tends to be adjusted higher for fear of loose contact. But if the pressure is excessive and bend the P.C.board, it may crack the chip capacitors or peel the terminations off. Please adjust the check pins not to bend the P.C.board.</p> <table border="1" data-bbox="475 389 1433 689"> <thead> <tr> <th data-bbox="475 389 616 454">Item</th> <th data-bbox="616 389 1034 454">Not recommended</th> <th data-bbox="1034 389 1433 454">Recommended</th> </tr> </thead> <tbody> <tr> <td data-bbox="475 454 616 689">Board bending</td> <td data-bbox="616 454 1034 689">  </td> <td data-bbox="1034 454 1433 689">  </td> </tr> </tbody> </table>	Item	Not recommended	Recommended	Board bending		
Item	Not recommended	Recommended						
Board bending								
10	Handling of loose chip capacitors	<p>1) If dropped the chip capacitors may crack. Once dropped do not use it. Especially, the large case sized chip capacitors are tendency to have cracks easily, so please handle with care.</p>  <p>2) Piling the P.C.board after mounting for storage or handling, the corner of the P.C. board may hit the chip capacitors of another board to cause crack.</p> 						
11	Capacitance aging	The capacitors (Class 2) have aging in the capacitance. They may not be used in precision time constant circuit. In case of the time constant circuit, the evaluation should be done well.						
12	Estimated life and estimated failure rate of capacitors	As per the estimated life and the estimated failure rate depend on the temperature and the voltage. This can be calculated by the equation described in JEITA RCR-2335C Annex F (Informative) Calculation of the estimated lifetime and the estimated failure rate ( Voltage acceleration coefficient : 3 multiplication rule, Temperature acceleration coefficient : 10°C rule) The failure rate can be decreased by reducing the temperature and the voltage but they will not be guaranteed.						

No.	Process	Condition
13	Caution during operation of equipment	<p>1) A capacitor shall not be touched directly with bare hands during operation in order to avoid electric shock. Electric energy held by the capacitor may be discharged through the human body when touched with a bare hand. Even when the equipment is off, a capacitor may stay charged. The capacitor should be handled after being completely discharged using a resistor.</p> <p>2) The terminals of a capacitor shall not be short-circuited by any accidental contact with a conductive object. A capacitor shall not be exposed to a conductive liquid such as an acid or alkali solution. A conductive object or liquid, such as acid and alkali, between the terminals may lead to the breakdown of a capacitor due to short circuit</p> <p>3) Confirm that the environment to which the equipment will be exposed during transportation and operation meets the specified conditions. Do not to use the equipment in the following environments.</p> <p>(1) Environment where a capacitor is splattered with water or oil  (2) Environment where a capacitor is exposed to direct sunlight  (3) Environment where a capacitor is exposed to Ozone, ultraviolet rays or radiation  (4) Environment where a capacitor exposed to corrosive gas(e.g. hydrogen sulfide, sulfur dioxide, chlorine. ammonia gas etc.)  (5) Environment where a capacitor exposed to vibration or mechanical shock exceeding the specified limits.  (6) Atmosphere change with causes condensation</p>
14	Others  Caution	<p>The product listed in this specification is intended for use in automotive applications under-normal operation and usage conditions.</p> <p>The product is not designed or warranted to meet the requirements of application listed below, whose performance and/or quality requires a more stringent level of safety or reliability, or whose failure, malfunction or defect could cause serious damage to society, person or property. Please understand that we are not responsible for any damage or liability caused by use of the products in any of the applications below or for any other use exceeding the range or conditions set forth in this specification sheet. If you intend to use the products in the applications listed below or if you have special requirements exceeding the range or conditions set forth in this specification, please contact us.</p> <p>(1) Aerospace/Aviation equipment  (2) Transportation equipment (electric trains, ships etc.)  (3) Medical equipment (Excepting Pharmaceutical Affairs Law classification Class1, 2)  (4) Power-generation control equipment  (5) Atomic energy-related equipment  (6) Seabed equipment  (7) Transportation control equipment  (8) Public information-processing equipment  (9) Military equipment  (10) Electric heating apparatus, burning equipment  (11) Disaster prevention/crime prevention equipment  (12) Safety equipment  (13) Other applications that are not considered general-purpose applications</p> <p>When designing your equipment even for general-purpose applications, you are kindly requested to take into consideration securing protection circuit/device or providing backup circuits in your equipment.</p> <p>In addition, although the product listed in this specification is intended for use in automotive applications as described above, it is not prohibited to use for general electronic equipment, whose performance and/or quality doesn't require a more stringent level of safety or reliability, or whose failure, malfunction or defect could not cause serious damage to society, person or property.</p> <p>Therefore, the description of this caution will be applied, when the product is used in general electronic equipment under a normal operation and usage conditions.</p>

## 14. TAPE PACKAGING SPECIFICATION

### 1. CONSTRUCTION AND DIMENSION OF TAPING

#### 1-1. Dimensions of carrier tape

Dimensions of paper tape shall be according to Appendix 3, 4.

Dimensions of plastic tape shall be according to Appendix 5, 6.

#### 1-2. Bulk part and leader of taping

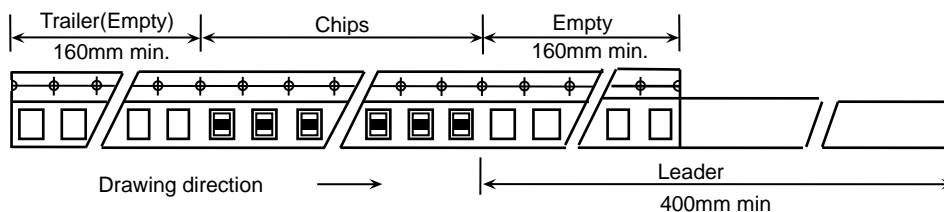

#### 1-3. Dimensions of reel

Dimensions of  $\varnothing 178$  reel shall be according to Appendix 7, 8.

Dimensions of  $\varnothing 330$  reel shall be according to Appendix 9, 10.

#### 1-4. Structure of taping

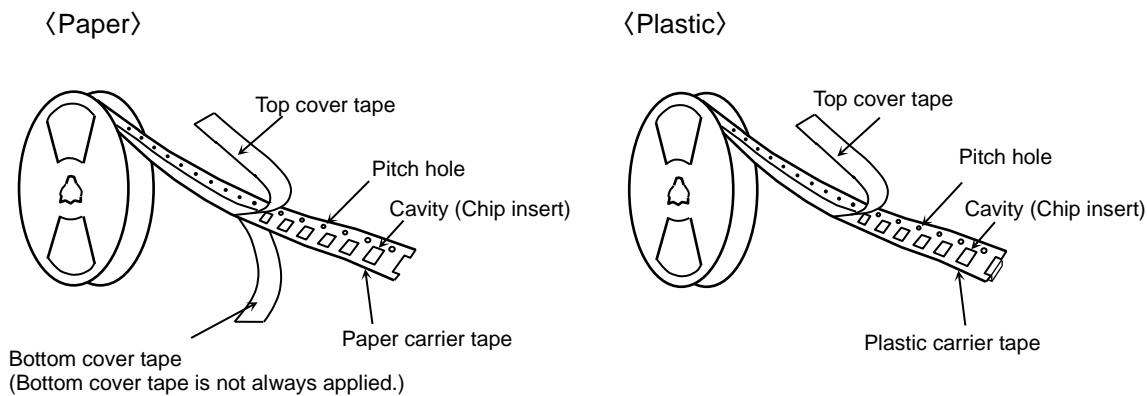

### 2. CHIP QUANTITY

Please refer to detail page on TDK web.

### 3. PERFORMANCE SPECIFICATIONS

#### 3-1. Fixing peeling strength (top tape)

$$0.05\text{N} < \text{Peeling strength} < 0.7\text{N}$$

〈Paper〉

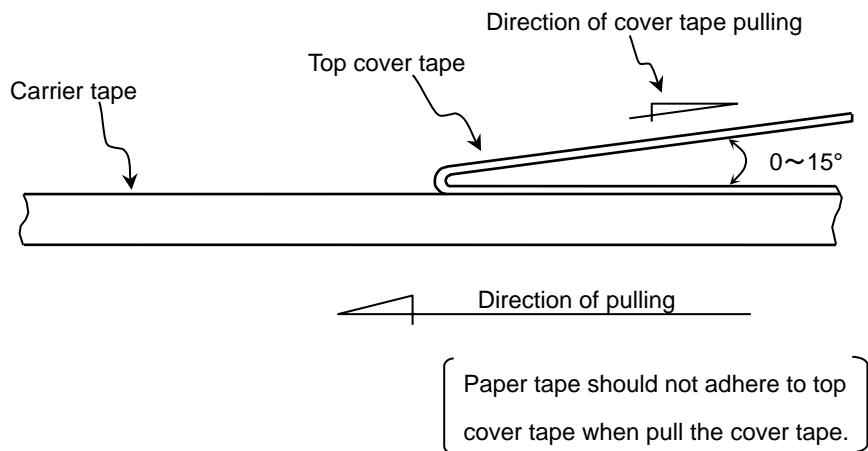

〈Plastic〉

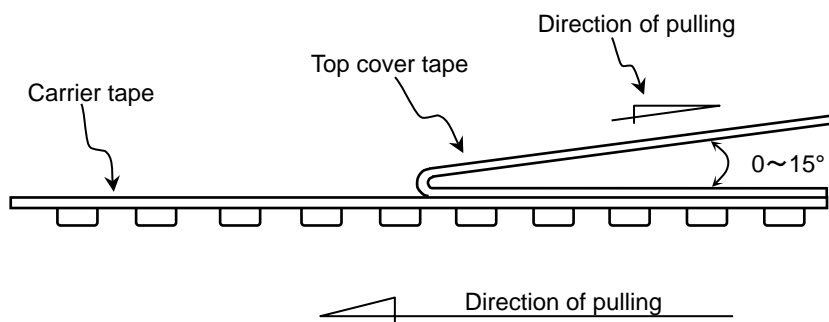

3-2. Carrier tape shall be flexible enough to be wound around a minimum radius of 30mm with components in tape.

3-3. The missing of components shall be less than 0.1%

3-4. Components shall not stick to fixing tape.

3-5. When removing the cover tape, there shall not be difficulties by unfitting clearance gap, burrs and crushes of cavities. Also the sprocket holes shall not be covered by absorbing dust into the suction nozzle.

### Appendix 3

#### Paper Tape

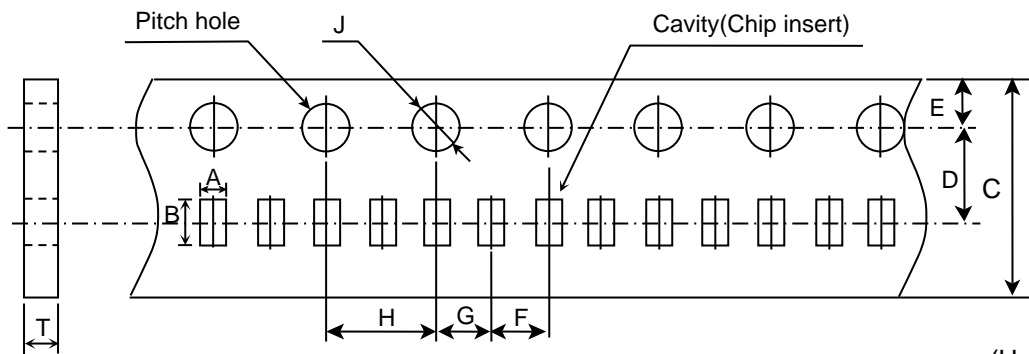

(Unit : mm)

Symbol	A	B	C	D	E	F
Case size						
CGA2 (CC0402)	( 0.65 )	( 1.15 )	8.00 ± 0.30	3.50 ± 0.05	1.75 ± 0.10	2.00 ± 0.05

Symbol	G	H	J	T
Case size				
CGA2 (CC0402)	2.00 ± 0.05	4.00 ± 0.10	∅ 1.5 <sup>+0.10</sup> <sub>0</sub>	0.60±0.05

( ) Reference value.

### Appendix 4

#### Paper Tape

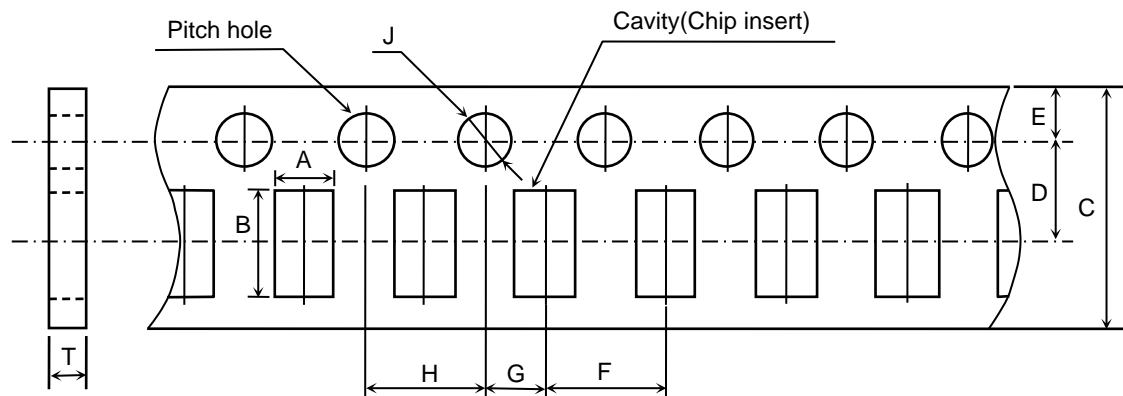

(Unit : mm)

Symbol	A	B	C	D	E	F
Case size						
CGA3 (CC0603)	( 1.10 )	( 1.90 )	8.00 ± 0.30	3.50 ± 0.05	1.75 ± 0.10	4.00 ± 0.10
CGA4 (CC0805)	( 1.50 )	( 2.30 )				
CGA5 (CC1206)	( 1.90 )	( 3.50 )				

Symbol	G	H	J	T
Case size				
CGA3 (CC0603)	2.00 ± 0.05	4.00 ± 0.10	∅ 1.5 <sup>+0.10</sup> <sub>0</sub>	1.20 max.
CGA4 (CC0805)				
CGA5 (CC1206)				

( ) Reference value.

## Appendix 5

### Plastic Tape

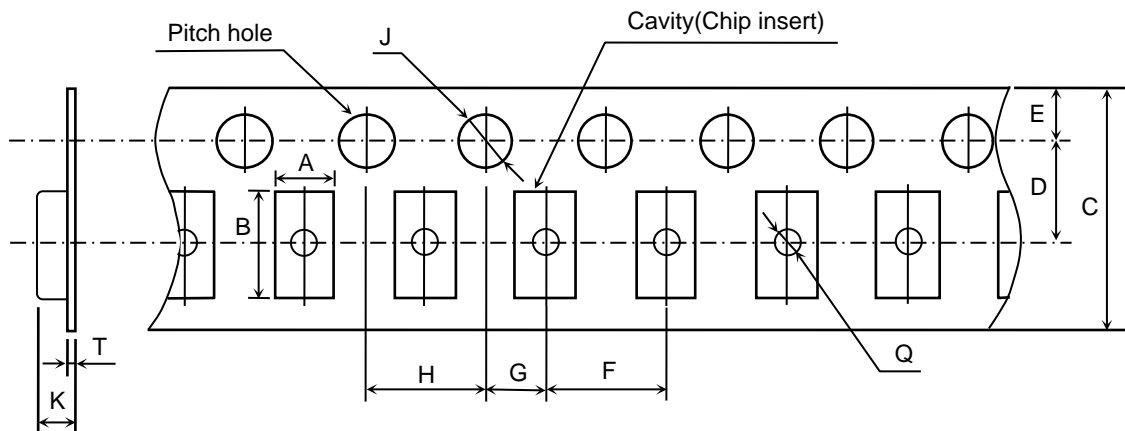

(Unit : mm)

Symbol	A	B	C	D	E	F
Case size						
CGA4 (CC0805)	( 1.50 )	( 2.30 )	8.00 ± 0.30	3.50 ± 0.05	1.75 ± 0.10	4.00 ± 0.10
CGA5 (CC1206)	( 1.90 )	( 3.50 )				
CGA6 (CC1210)	( 2.90 )	( 3.60 )	8.00 ± 0.30 or 12.0 ± 0.30	3.50 ± 0.05 or 5.50 ± 0.05		
Symbol	G	H	J	K	T	Q
Case size						
CGA4 (CC0805)	2.00 ± 0.05	4.00 ± 0.10	∅ 1.5 <sup>+0.10</sup> <sub>0</sub>	2.50 max.	0.60 max.	∅ 0.50 min.
CGA5 (CC1206)				3.40 max.		
CGA6 (CC1210)						

( ) Reference value.

Exceptionally no hole in the cavity is applied. Please inquire if hole in cavity is mandatory.

## Appendix 6

### Plastic Tape

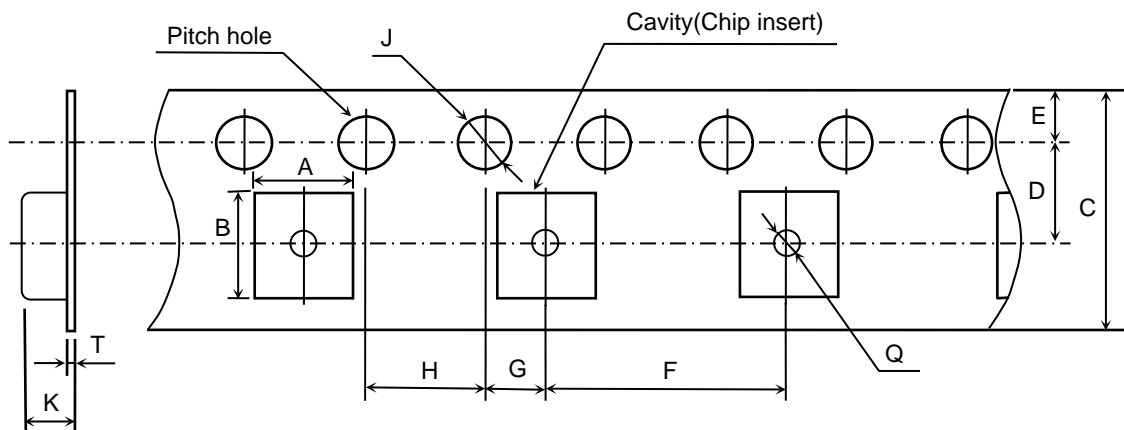

(Unit : mm)

Symbol	A	B	C	D	E	F
Case size						
CGA8 (CC1812)	( 3.60 )	( 4.90 )	12.0 ± 0.30	5.50 ± 0.05	1.75 ± 0.10	8.00 ± 0.10
CGA9 (CC2220)	( 5.40 )	( 6.10 )				
Symbol	G	H	J	K	T	Q
Case size						
CGA8 (CC1812)	2.00 ± 0.05	4.00 ± 0.10	∅ 1.5 $\begin{matrix} +0.10 \\ 0 \end{matrix}$	6.50 max.	0.60 max.	∅ 1.50 min.
CGA9 (CC2220)						

( ) Reference value.

Exceptionally no hole in the cavity is applied. Please inquire if hole in cavity is mandatory.



### Appendix 7

Dimensions of reel (Material : Polystyrene)  
CGA2, CGA3, CGA4, CGA5, CGA6( 8mm width taping type )

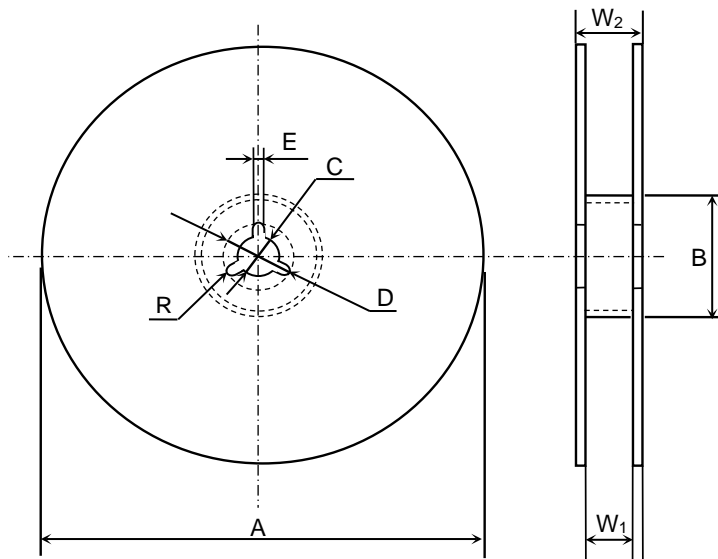

(Unit : mm)

Symbol	A	B	C	D	E	W <sub>1</sub>
Dimension	∅178 ± 2.0	∅60 ± 2.0	∅13 ± 0.5	∅21 ± 0.8	2.0 ± 0.5	9.0 ± 0.3
Symbol	W <sub>2</sub>	R				
Dimension	13.0 ± 1.4	1.0				

### Appendix 8

Dimensions of reel (Material : Polystyrene)  
CGA6( 12mm width taping type ), CGA8, CGA9

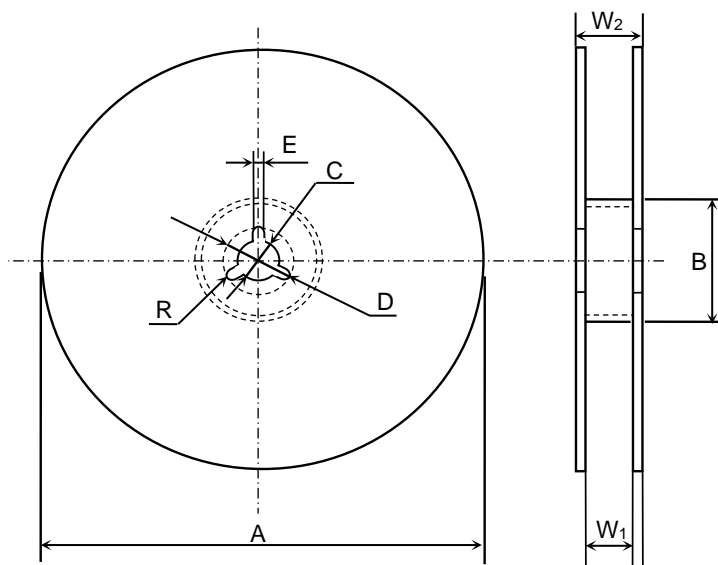

(Unit : mm)

Symbol	A	B	C	D	E	W <sub>1</sub>
Dimension	∅178 ± 2.0	∅60 ± 2.0	∅13 ± 0.5	∅21 ± 0.8	2.0 ± 0.5	13.0 ± 0.3
Symbol	W <sub>2</sub>	R				
Dimension	17.0 ± 1.4	1.0				

### Appendix 9

Dimensions of reel (Material : Polystyrene)  
CGA2, CGA3, CGA4, CGA5, CGA6( 8mm width taping type )

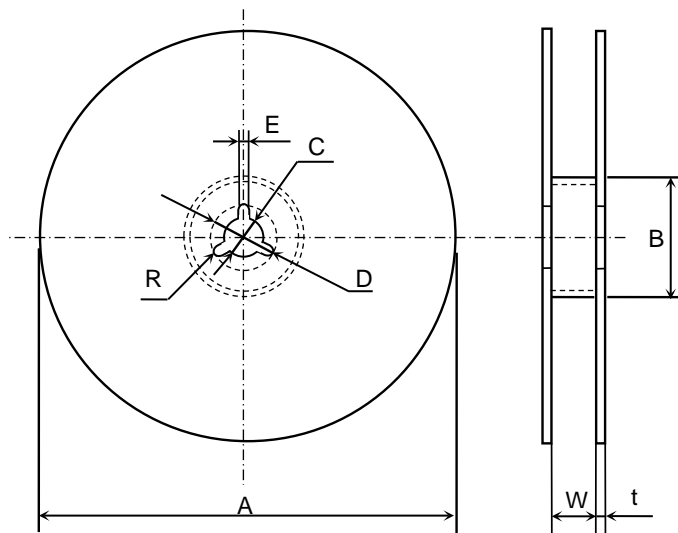

(Unit : mm)

Symbol	A	B	C	D	E	W
Dimension	Ø382 max. (Nominal Ø330)	Ø50 min.	Ø13 ± 0.5	Ø21 ± 0.8	2.0 ± 0.5	10.0 ± 1.5
Symbol	t	R				
Dimension	2.0 ± 0.5	1.0				

### Appendix 10

Dimensions of reel (Material : Polystyrene)  
CGA6( 12mm width taping type ), CGA8, CGA9

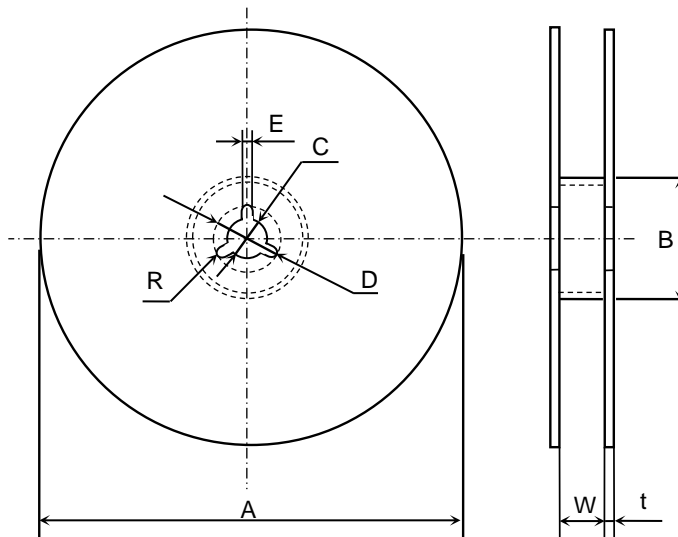

(Unit : mm)

Symbol	A	B	C	D	E	W
Dimension	Ø382 max. (Nominal Ø330)	Ø50 min.	Ø13 ± 0.5	Ø21 ± 0.8	2.0 ± 0.5	14.0 ± 1.5
Symbol	t	R				
Dimension	2.0 ± 0.5	1.0				

## X-ON Electronics

Largest Supplier of Electrical and Electronic Components

*Click to view similar products for [Multilayer Ceramic Capacitors MLCC - SMD/SMT](#) category:*

*Click to view products by [TDK](#) manufacturer:*

Other Similar products are found below :

[M39014/02-1218V](#) [M39014/02-1225V](#) [M39014/22-0631](#) [D55342E07B523DR-T/R](#) [NCA1206X7R103K50TRPF](#) [NCA1206X7R104K16TRPF](#)  
[NIN-FC2R7JTRF](#) [NMC0402NPO220J50TRPF](#) [NMC0402X5R105K6.3TRPF](#) [NMC0402X5R224K6.3TRPF](#) [NMC0402X7R103J25TRPF](#)  
[NMC0402X7R392K50TRPF](#) [NMC0603NPO201J50TRPF](#) [NMC0603X5R475M6.3TRPF](#) [NMC0603X7R333K16TRPF](#)  
[NMC0805NPO820J50TRPF](#) [NMC0805X7R224K16TRPLPF](#) [NMC1206X7R102K50TRPF](#) [NMC1206X7R106K10TRPLPF](#)  
[NMC1206X7R475K10TRPLPF](#) [C1608C0G2A221J](#) [C1608X7R1E334K](#) [C2012C0G2A472J](#) [2220J2K00562KXT](#) [CDR33BX104AKUR](#)  
[CDR33BX683AKUS](#) [CGA3E1X7R1C684K](#) [CL10C0R8BB8ANNC](#) [C1005X5R0G225M](#) [C2012X7R2E223K](#) [C3216C0G2J272J](#)  
[D55342E07B35E7R-T/R](#) [NMC0402NPO150G50TRPF](#) [NMC0402NPO560F50TRPF](#) [NMC0402X7R562J25TRPF](#)  
[NMC0603NPO102J25TRPF](#) [NMC1206X7R332K50TRPF](#) [726632-1](#) [CGA6M3X7R1H225K](#) [CGA5L2X7R2A105K](#) [CGA3E2X8R1H223K](#)  
[CDR33BX823AKUR\M500](#) [CDR35BX474AKUR\M500](#) [CDR35BX104BKUR\M500](#) [69995D](#) [NMC0201X5R473K6.3TRPF](#)  
[NMC0201X7R221K25TRPF](#) [NMC0402X5R105K10TRPF](#) [NMC0402X5R224K10TRPF](#) [NMC0603X7R104J25TRPF](#)