



# Disc Type Capacitors with Lead

High Voltage Ceramic Capacitors

Commercial Grade

## CK45 series

---

Type: CK45 [B, E characteristics, Edc: 1kV to 3kV]



## REMINDERS FOR USING THESE PRODUCTS

Before using these products, be sure to request the delivery specifications.

### SAFETY REMINDERS

Please pay sufficient attention to the warnings for safe designing when using these products.

#### REMINDERS

- Do not use or store in locations where there are conditions such as gas corrosion (salt, acid, alkali, etc.).
- Before soldering, be sure to preheat components.  
The preheating temperature should be set so that the temperature difference between the solder temperature and product temperature does not exceed 150°C.
- Soldering corrections after mounting should be within the range of the conditions determined in the specifications.  
If overheated, a short circuit, performance deterioration, or lifespan shortening may occur.
- Self heating (temperature increase) occurs when the power is turned ON, so the tolerance should be sufficient for the set thermal design.
- Do not use for a purpose outside of the contents regulated in the delivery specifications.
- The products listed on this catalog are intended for use in general electronic equipment (AV equipment, telecommunications equipment, home appliances, amusement equipment, computer equipment, personal equipment, office equipment, measurement equipment, industrial robots) under a normal operation and use condition.  
The products are not designed or warranted to meet the requirements of the applications listed below, whose performance and/or quality require a more stringent level of safety or reliability, or whose failure, malfunction or trouble could cause serious damage to society, person or property.  
If you intend to use the products in the applications listed below or if you have special requirements exceeding the range or conditions set forth in the each catalog, please contact us.
 

<ul style="list-style-type: none"> <li>(1) Aerospace/Aviation equipment</li> <li>(2) Transportation equipment (cars, electric trains, ships, etc.)</li> <li>(3) Medical equipment</li> <li>(4) Power-generation control equipment</li> <li>(5) Atomic energy-related equipment</li> <li>(6) Seabed equipment</li> <li>(7) Transportation control equipment</li> </ul>	<ul style="list-style-type: none"> <li>(8) Public information-processing equipment</li> <li>(9) Military equipment</li> <li>(10) Electric heating apparatus, burning equipment</li> <li>(11) Disaster prevention/crime prevention equipment</li> <li>(12) Safety equipment</li> <li>(13) Other applications that are not considered general-purpose applications</li> </ul>
---	---
- Please refer to the guideline of notabilia for fixed ceramic capacitors issued by JEITA(Japan Electronics and Information Technology Association, EIAJ RCR-2335).

When designing your equipment even for general-purpose applications, you are kindly requested to take into consideration securing protection circuit/device or providing backup circuits in your equipment.

# Disc Type Capacitors with Lead

## High Voltage Ceramic Capacitors, Commercial Grade

Product compatible with RoHS directive  
Halogen-free

# Overview of CK45 Series

## FEATURES

- These products shall conform to RoHS Directive due to lead(Pb) free of lead wire and internal solder material.
- Compatible with halogen-free external resin coating.

## APPLICATION

For use in DC ballast

## PART NUMBER CONSTRUCTION

CK45	-	B	3AD	102	K	Y		N	A				
Series name*	Temperature characteristics	Rated voltage		Nominal capacitance		Capacitance tolerance		Class	Lead type	Application classification	Internal code		
B	±10%	3AD	1kV	101	100pF	K	±10%	G	Long lead	N	General use	A	Halogen-free
E	+20, -55%	3DD	2kV	222	2,200pF	Z	+80, -20%	N	Short lead				
		3FD	3kV	103	10,000pF			V	Taping				

\* Please refer to P-5-10 about the product dimensions.

## OPERATING TEMPERATURE RANGE

Temperature characteristics	Temperature range*	
	Operating temperature (°C)	Storage temperature** (°C)
B	-25 to +105	-25 to +105
E	-25 to +105	-25 to +105

\* The maximum operating temperature of 105°C includes capacitor self-generated heat of up to 20°C.

\*\* After capacitor is mounted on board, the storage temperature range is applied.

## PACKAGE QUANTITY

Type	Package quantity	
	Taping (pieces / box)	Bulk (pieces / bag)
CK45	1000	1000

\* 500 pieces applies to the following part.  
CK45-E3DD103ZYVNA

- RoHS Directive Compliant Product: See the following for more details related to RoHS Directive compliant products. <http://product.tdk.com/en/environment/rohs/>
- Halogen-free: Indicates that Cl content is less than 900ppm, Br content is less than 900ppm, and that the total Cl and Br content is less than 1500ppm.

 Please be sure to request delivery specifications that provide further details on the features and specifications of the products for proper and safe use. Please note that the contents may change without any prior notice due to reasons such as upgrading.

# Overview of CK45 Series

## RECOMMENDED FLOW PROFILE

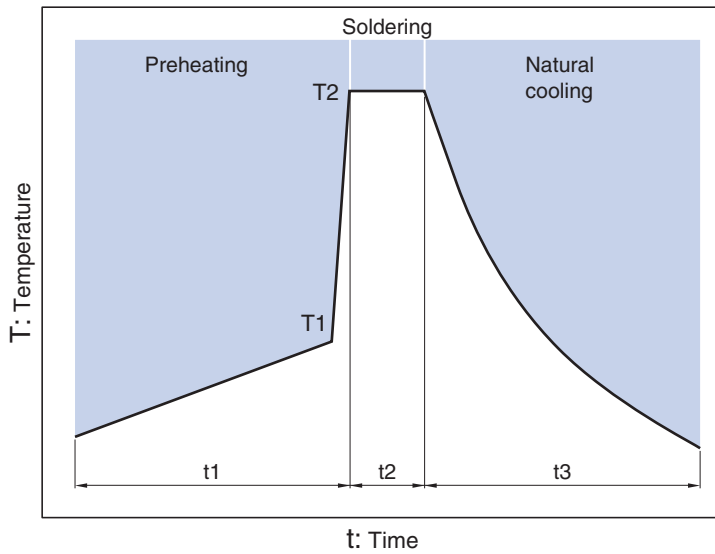

Preheating		Peak		Natural cooling
Temp.	Time	Temp.	Time	Time
T1	t1	T2	t2	t3
110°C min.	30 to 60s.	260°C	Within 10s.	Over 60s.

# CK45 Type

## CAPACITANCE AND DIMENSIONS

□ Temperature Characteristics: B ( $\pm 10\%$ )

□ Rated Voltage Edc: 1kV

Capacitance (pF)	Capacitance tolerance	Dimensions (mm)		F (Applied to bulk)	F (Applied to taping)	d	Taping dimensions***	Part No.*
		D max.	T max.					
100	$\pm 10\%$	5.5	5.0	$5.0 \pm 1.5$	$5.0 + 0.8, -0.2$	$0.6 \pm 0.05$	V1	CK45-B3AD101KY□NA**
150	$\pm 10\%$	5.5	5.0	$5.0 \pm 1.5$	$5.0 + 0.8, -0.2$	$0.6 \pm 0.05$	V1	CK45-B3AD151KY□NA
220	$\pm 10\%$	5.5	5.0	$5.0 \pm 1.5$	$5.0 + 0.8, -0.2$	$0.6 \pm 0.05$	V1	CK45-B3AD221KY□NA
330	$\pm 10\%$	5.5	5.0	$5.0 \pm 1.5$	$5.0 + 0.8, -0.2$	$0.6 \pm 0.05$	V1	CK45-B3AD331KY□NA
470	$\pm 10\%$	5.5	5.0	$5.0 \pm 1.5$	$5.0 + 0.8, -0.2$	$0.6 \pm 0.05$	V1	CK45-B3AD471KY□NA
680	$\pm 10\%$	5.5	5.0	$5.0 \pm 1.5$	$5.0 + 0.8, -0.2$	$0.6 \pm 0.05$	V1	CK45-B3AD681KY□NA
1,000	$\pm 10\%$	6.0	5.0	$5.0 \pm 1.5$	$5.0 + 0.8, -0.2$	$0.6 \pm 0.05$	V1	CK45-B3AD102KY□NA
1,500	$\pm 10\%$	7.0	5.0	$5.0 \pm 1.5$	$5.0 + 0.8, -0.2$	$0.6 \pm 0.05$	V1	CK45-B3AD152KY□NA
2,200	$\pm 10\%$	8.5	5.0	$5.0 \pm 1.5$	$5.0 + 0.8, -0.2$	$0.6 \pm 0.05$	V1	CK45-B3AD222KY□NA
3,300	$\pm 10\%$	9.5	5.0	$5.0 \pm 1.5$	$5.0 + 0.8, -0.2$	$0.6 \pm 0.05$	V1	CK45-B3AD332KY□NA
4,700	$\pm 10\%$	11.0	5.0	$5.0 \pm 1.5$	$5.0 + 0.8, -0.2$	$0.6 \pm 0.05$	V1	CK45-B3AD472KY□NA

\* The part numbers are TDK's standard specification products.

\*\* The "□" of the Part Number contains the lead type, G, N or V. Please refer to the details of each shape is shown below.

\*\*\* Please refer to P-11 about the taping dimensions.

## LIST OF STANDARD LEAD SHAPES

Dimensions in mm

	Symbol G Bulk/Long lead	Symbol N Bulk/Short lead	Symbol V Taping
Vertical kink			

- TDK's standard product is vertical kink.
- TDK's recommendation is short lead type with the symbol N for bulk products.

Please be sure to request delivery specifications that provide further details on the features and specifications of the products for proper and safe use. Please note that the contents may change without any prior notice due to reasons such as upgrading.

# CK45 Type

## CAPACITANCE AND DIMENSIONS

□ Temperature Characteristics: B ( $\pm 10\%$ )

□ Rated Voltage Edc: 2kV

Capacitance (pF)	Capacitance tolerance	Dimensions (mm)		F (Applied to bulk)	F (Applied to taping)	d	Taping dimensions***	Part No.*
		D max.	T max.					
100	$\pm 10\%$	5.5	5.0	$5.0 \pm 1.5$	$5.0 + 0.8, -0.2$	$0.6 \pm 0.05$	V1	CK45-B3DD101KY□NA**
150	$\pm 10\%$	5.5	5.0	$5.0 \pm 1.5$	$5.0 + 0.8, -0.2$	$0.6 \pm 0.05$	V1	CK45-B3DD151KY□NA
220	$\pm 10\%$	5.5	5.0	$5.0 \pm 1.5$	$5.0 + 0.8, -0.2$	$0.6 \pm 0.05$	V1	CK45-B3DD221KY□NA
330	$\pm 10\%$	5.5	5.0	$5.0 \pm 1.5$	$5.0 + 0.8, -0.2$	$0.6 \pm 0.05$	V1	CK45-B3DD331KY□NA
470	$\pm 10\%$	5.5	5.0	$5.0 \pm 1.5$	$5.0 + 0.8, -0.2$	$0.6 \pm 0.05$	V1	CK45-B3DD471KY□NA
680	$\pm 10\%$	6.5	5.0	$5.0 \pm 1.5$	$5.0 + 0.8, -0.2$	$0.6 \pm 0.05$	V1	CK45-B3DD681KY□NA
1,000	$\pm 10\%$	7.5	5.0	$5.0 \pm 1.5$	$5.0 + 0.8, -0.2$	$0.6 \pm 0.05$	V1	CK45-B3DD102KY□NA
1,500	$\pm 10\%$	8.5	5.0	$5.0 \pm 1.5$	$5.0 + 0.8, -0.2$	$0.6 \pm 0.05$	V1	CK45-B3DD152KY□NA
2,200	$\pm 10\%$	10.0	5.0	$5.0 \pm 1.5$	$5.0 + 0.8, -0.2$	$0.6 \pm 0.05$	V1	CK45-B3DD222KY□NA
3,300	$\pm 10\%$	11.5	5.0	$7.5 \pm 1.5$	$7.5 \pm 0.8$	$0.6 \pm 0.05$	V2	CK45-B3DD332KY□NA
4,700	$\pm 10\%$	14.0	5.0	$7.5 \pm 1.5$	$7.5 \pm 0.8$	$0.6 \pm 0.05$	V2	CK45-B3DD472KY□NA

\* The part numbers are TDK's standard specification products.

\*\* The "□" of the Part Number contains the lead type, G, N or V. Please refer to the details of each shape is shown below.

\*\*\* Please refer to P-11 about the taping dimensions.

## LIST OF STANDARD LEAD SHAPES

Dimensions in mm

	Symbol G Bulk/Long lead	Symbol N Bulk/Short lead	Symbol V Taping
Vertical kink			

- TDK's standard product is vertical kink.
- TDK's recommendation is short lead type with the symbol N for bulk products.

⚠ Please be sure to request delivery specifications that provide further details on the features and specifications of the products for proper and safe use. Please note that the contents may change without any prior notice due to reasons such as upgrading.

# CK45 Type

## CAPACITANCE AND DIMENSIONS

□ Temperature Characteristics: B ( $\pm 10\%$ )

□ Rated Voltage Edc: 3kV

Capacitance (pF)	Capacitance tolerance	Dimensions (mm)		F (Applied to bulk)	F (Applied to taping)	d	Taping dimensions***	Part No.*
		D max.	T max.					
100	$\pm 10\%$	5.5	6.0	$7.5 \pm 1.5$	$7.5 \pm 0.8$	$0.6 \pm 0.05$	V2	CK45-B3FD101KY□NA**
150	$\pm 10\%$	5.5	6.0	$7.5 \pm 1.5$	$7.5 \pm 0.8$	$0.6 \pm 0.05$	V2	CK45-B3FD151KY□NA
220	$\pm 10\%$	5.5	6.0	$7.5 \pm 1.5$	$7.5 \pm 0.8$	$0.6 \pm 0.05$	V2	CK45-B3FD221KY□NA
330	$\pm 10\%$	6.5	6.0	$7.5 \pm 1.5$	$7.5 \pm 0.8$	$0.6 \pm 0.05$	V2	CK45-B3FD331KY□NA
470	$\pm 10\%$	7.0	6.0	$7.5 \pm 1.5$	$7.5 \pm 0.8$	$0.6 \pm 0.05$	V2	CK45-B3FD471KY□NA
680	$\pm 10\%$	8.0	6.0	$7.5 \pm 1.5$	$7.5 \pm 0.8$	$0.6 \pm 0.05$	V2	CK45-B3FD681KY□NA
1,000	$\pm 10\%$	9.0	6.0	$7.5 \pm 1.5$	$7.5 \pm 0.8$	$0.6 \pm 0.05$	V2	CK45-B3FD102KY□NA
1,500	$\pm 10\%$	10.5	6.0	$7.5 \pm 1.5$	$7.5 \pm 0.8$	$0.6 \pm 0.05$	V2	CK45-B3FD152KY□NA
2,200	$\pm 10\%$	12.5	6.0	$7.5 \pm 1.5$	$7.5 \pm 0.8$	$0.6 \pm 0.05$	V2	CK45-B3FD222KY□NA

\* The part numbers are TDK's standard specification products.

\*\* The "□" of the Part Number contains the lead type, G, N or V. Please refer to the details of each shape is shown below.

\*\*\* Please refer to P-11 about the taping dimensions.

## LIST OF STANDARD LEAD SHAPES

Dimensions in mm

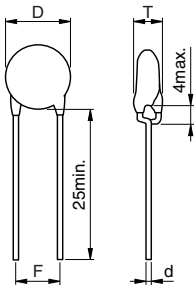
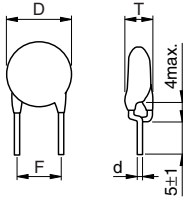
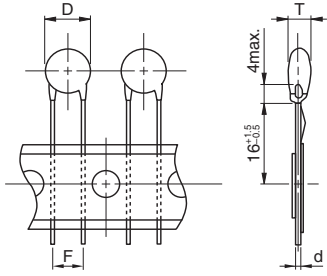
	Symbol G Bulk/Long lead	Symbol N Bulk/Short lead	Symbol V Taping
Vertical kink			

- TDK's standard product is vertical kink.
- TDK's recommendation is short lead type with the symbol N for bulk products.

⚠ Please be sure to request delivery specifications that provide further details on the features and specifications of the products for proper and safe use. Please note that the contents may change without any prior notice due to reasons such as upgrading.

# CK45 Type

## CAPACITANCE AND DIMENSIONS

□ Temperature Characteristics: E (+20, -55%)

□ Rated Voltage Edc: 1kV

Capacitance (pF)	Capacitance tolerance	Dimensions (mm)		F (Applied to bulk)	F (Applied to taping)	d	Taping dimensions***	Part No.*
		D max.	T max.					
470	+80, -20%	5.5	5.0	5.0±1.5	5.0+0.8, -0.2	0.6±0.05	V1	CK45-E3AD471ZY□NA**
1,000	+80, -20%	5.5	5.0	5.0±1.5	5.0+0.8, -0.2	0.6±0.05	V1	CK45-E3AD102ZY□NA
2,200	+80, -20%	6.5	5.0	5.0±1.5	5.0+0.8, -0.2	0.6±0.05	V1	CK45-E3AD222ZY□NA
4,700	+80, -20%	8.5	5.0	5.0±1.5	5.0+0.8, -0.2	0.6±0.05	V1	CK45-E3AD472ZY□NA
10,000	+80, -20%	11.5	5.0	7.5±1.5	7.5±0.8	0.6±0.05	V2	CK45-E3AD103ZY□NA

\* The part numbers are TDK's standard specification products.

\*\* The "□" of the Part Number contains the lead type, G, N or V. Please refer to the details of each shape is shown below.

\*\*\* Please refer to P-11 about the taping dimensions.

## LIST OF STANDARD LEAD SHAPES

Dimensions in mm

	Symbol G Bulk/Long lead	Symbol N Bulk/Short lead	Symbol V Taping
Vertical kink			

• TDK's standard product is vertical kink.

• TDK's recommendation is short lead type with the symbol N for bulk products.

Please be sure to request delivery specifications that provide further details on the features and specifications of the products for proper and safe use. Please note that the contents may change without any prior notice due to reasons such as upgrading.



# CK45 Type

## CAPACITANCE AND DIMENSIONS

□ Temperature Characteristics: E (+20, -55%)

□ Rated Voltage Edc: 2kV

Capacitance (pF)	Capacitance tolerance	Dimensions (mm)		F (Applied to bulk)	F (Applied to taping)	d	Taping dimensions***	Part No.*
		D max.	T max.					
470	+80, -20%	5.5	5.0	5.0±1.5	5.0+0.8, -0.2	0.6±0.05	V1	CK45-E3DD471ZY□NA**
1,000	+80, -20%	6.0	5.0	5.0±1.5	5.0+0.8, -0.2	0.6±0.05	V1	CK45-E3DD102ZY□NA
2,200	+80, -20%	8.0	5.0	5.0±1.5	5.0+0.8, -0.2	0.6±0.05	V1	CK45-E3DD222ZY□NA
4,700	+80, -20%	10.5	5.0	5.0±1.5	5.0+0.8, -0.2	0.6±0.05	V1	CK45-E3DD472ZY□NA
10,000	+80, -20%	14.5	5.0	7.5±1.5	7.5±0.8	0.6±0.05	V3	CK45-E3DD103ZY□NA

\* The part numbers are TDK's standard specification products.

\*\* The "□" of the Part Number contains the lead type, G, N or V. Please refer to the details of each shape is shown below.

\*\*\* Please refer to P-11 about the taping dimensions.

## LIST OF STANDARD LEAD SHAPES

Dimensions in mm

	Symbol G Bulk/Long lead	Symbol N Bulk/Short lead	Symbol V Taping
Vertical kink			

• TDK's standard product is vertical kink.

• TDK's recommendation is short lead type with the symbol N for bulk products.

# CK45 Type

## CAPACITANCE AND DIMENSIONS

□ Temperature Characteristics: E (+20, -55%)

□ Rated Voltage Edc: 3kV

Capacitance (pF)	Capacitance tolerance	Dimensions (mm)		F (Applied to bulk)	F (Applied to taping)	d	Taping dimensions***	Part No.*
		D max.	T max.					
470	+80, -20%	6.0	6.0	7.5±1.5	7.5±0.8	0.6±0.05	V2	CK45-E3FD471ZY□NA**
1,000	+80, -20%	7.5	6.0	7.5±1.5	7.5±0.8	0.6±0.05	V2	CK45-E3FD102ZY□NA
2,200	+80, -20%	9.5	6.0	7.5±1.5	7.5±0.8	0.6±0.05	V2	CK45-E3FD222ZY□NA
4,700	+80, -20%	12.5	6.0	7.5±1.5	7.5±0.8	0.6±0.05	V2	CK45-E3FD472ZY□NA

\* The part numbers are TDK's standard specification products.

\*\* The "□" of the Part Number contains the lead type, G, N or V. Please refer to the details of each shape is shown below.

\*\*\* Please refer to P-11 about the taping dimensions.

## LIST OF STANDARD LEAD SHAPES

Dimensions in mm

	Symbol G Bulk/Long lead	Symbol N Bulk/Short lead	Symbol V Taping
Vertical kink			

- TDK's standard product is vertical kink.
- TDK's recommendation is short lead type with the symbol N for bulk products.

# CK45 Type

## TAPING DIMENSIONS

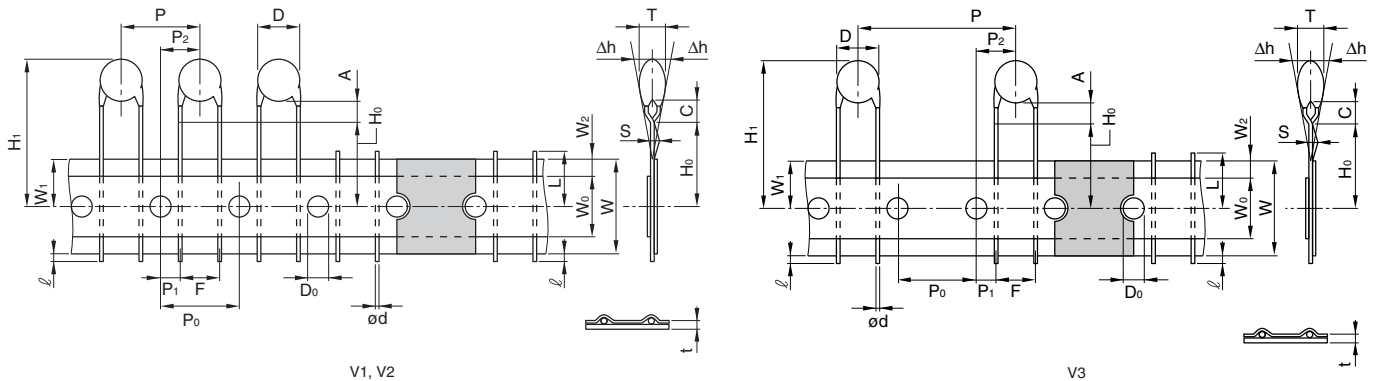

Item	Symbol	Dimensions(mm)			Remarks
		V1	V2	V3	
Body diameter	D	Depends on the specification of each product.			
Body thickness	T	Depends on the specification of each product.			
Lead-wire diameter	ød	0.6±0.05	0.6±0.05	0.6±0.05	
Pitch of component	P	12.7±1.0	15.0±1.0	30.0±1.0	Including the slant of body
Feed hole pitch	P <sub>0</sub>	12.7±0.3	15.0±0.3	15.0±0.3	Excepting the tape splicing part
Feed hole center to lead	P <sub>1</sub>	3.85±0.7	3.75±0.7	3.75±0.7	
Feed hole center to component center	P <sub>2</sub>	6.35±1.3	7.5±1.3	7.5±1.3	
Lead-to lead distance	F	5+0.8, -0.2	7.5±0.8	7.5±0.8	Measuring point is bottom kink
Component alignment	Δh	0±2.0	0±2.0	0±2.0	Including the slanting body due to bending lead-wire
Tape width	W	18.0+1.0, -0.5	18.0+1.0, -0.5	18.0+1.0, -0.5	
Adhesive tape width	W <sub>0</sub>	10.0min.	10.0min.	10.0min.	
Hole position	W <sub>1</sub>	9.0±0.5	9.0±0.5	9.0±0.5	
Adhesive tape position	W <sub>2</sub>	4.0max.	4.0max.	4.0max.	Adhesive tape do not stick out the tape
Bottom of kink from tape center	H <sub>0</sub>	16.0+1.5, -0.5	16.0+1.5, -0.5	16.0+1.5, -0.5	
Height of body from tape center	H <sub>1</sub>	46.0max.	46.0max.	46.0max.	
Lead-wire protrusion	ℓ	1.0max.	1.0max.	1.0max.	
Feed hole diameter	D <sub>0</sub>	4.0±0.2	4.0±0.2	4.0±0.2	
Total tape thickness	t	0.6±0.3	0.6±0.3	0.6±0.3	Including adhesive tape
Length of snapped lead	L	11.0max.	11.0max.	11.0max.	
Coating on lead	C	4.0max.	4.0max.	4.0max.	
Height of kink	A	4.0max.	4.0max.	4.0max.	Measuring point is bottom kink
Spring action	S	2.0max.	2.0max.	2.0max.	

## AMMO PACK INNER BOX SIZE

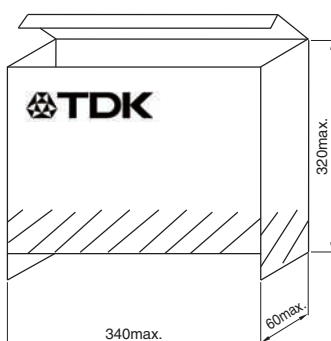

Dimensions in mm

- For more information about products with other capacitance or other data, please contact us.

⚠ Please be sure to request delivery specifications that provide further details on the features and specifications of the products for proper and safe use. Please note that the contents may change without any prior notice due to reasons such as upgrading.

## X-ON Electronics

Largest Supplier of Electrical and Electronic Components

*Click to view similar products for [Ceramic Disc Capacitors](#) category:*

*Click to view products by [TDK](#) manufacturer:*

Other Similar products are found below :

[009377XM](#) [5AS560JCFCA](#) [5AU100JCECA](#) [5AU470JCJCA](#) [DEF2CLH020CA3B](#) [HSE102MAQBF0KR](#) [432202101621](#) [432202282431](#)  
[DEF2CLH030CJ3B](#) [W1X223MCVCF0KR](#) [564RC0GBA302EJ470K](#) [5AS270JCDCA](#) [5AS330JCDCA](#) [5AU330JCGCA](#)  
[DE1E3KX222MJ4BN01F](#) [440LT68AP-R](#) [JN222MQ47FAAAAKPLP](#) [H8000090-245](#) [H8000090-225RY](#) [H8000090-309RY](#) [H8000090-](#)  
[291RY](#) [F471K39S3NR63K7R](#) [DEF2CLH040CN3A](#) [DEF2CLH080DA3B](#) [564R3DF0T22](#) [CC2150KY5P1KVB5LS-LF](#)  
[CC2180KY5P1KVB5LS-LF](#) [CC2470KY5P1KVB5LS-LF](#) [CC2820KY5P1KVB5LS-LF](#) [0838-040-X7R0-220K](#) [JN102MQ35FAAAAKPLP](#)  
[0841-040-X5U0-103M](#) [CCH-6K8-5/1000V](#) [140-50N2-101J-TB-RC](#) [ECK-DGL102ME](#) [562R5GAD47RR](#) [S103K75Y5PN8BT0R](#)  
[615R100GAD10](#) [615R150GAD10](#) [NCD100K1KVSLF](#) [NCD682M1KVZ5UF](#) [CCK-100N](#) [CCK-100P](#) [CCK-22N](#) [CCK-2N2](#) [CCK-47N](#) [CCK-](#)  
[47P](#) [CCK-4N7](#) [CCK-4P7](#) [CK45-B3FD681KYNNA](#)