

# SPECIFICATION

SPEC NO. TFA7NAA00523

DATE : Apr.24th,2020

To

Foxtar

CUSTOMER'S PRODUCT NAME

TDK'S PRODUCT NAME

DEA102025LT-6326B1

## RECEIPT CONFIRMATION

DATE :    YEAR    MONTH    DAY

TDK Corporation

Sales

Electronic Components Sales &  
Marketing Group

Engineering

Electronic Components Business Company  
Communication Devices Business Group

APPROVED	PERSON IN CHARGE

APPROVED	CHECKED	PERSON IN CHARGE
<i>H. Matsubara</i>	<i>M. Tsutsumi</i>	<i>H. Ashida</i>



**Low Pass Filter Specification**

( TDK Part Number : DEA102025LT-6326B1 )

**1. Marking**

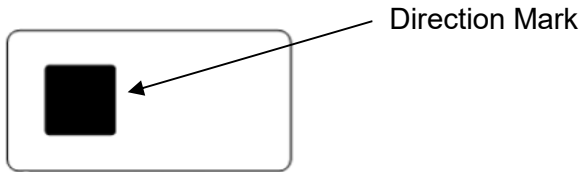

**2. Mechanical Outline**

**2-1 Package**

Package: Surface mount package  
 Delivery Medium: Tape on reel  
 Soldering Method: IR-reflow  
 Size: 1.00 x 0.50 mm typ.  
 Height: 0.40 mm max.

**Mechanical Dimensions**

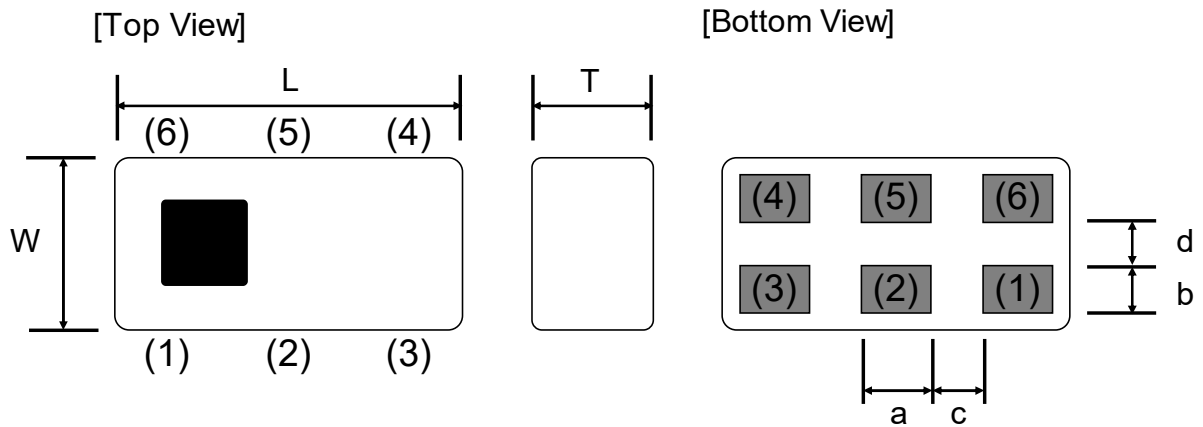

Dimensions (mm)

L	W	T	a	b	c	d
1.00	0.50	0.40	0.18	0.125	0.18	0.15
+/-0.05	+/-0.05	Max	+/-0.05	+/-0.05	+/-0.05	+/-0.05

Terminal functions

(1)	NC
(2)	GND
(3)	NC

(4)	Output Port
(5)	GND
(6)	Input Port

## 2-2 Coplanarity

0.05 mm max. difference in Z-direction as follows

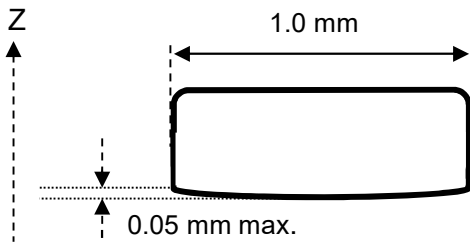

Coplanarity measurement method

Coplanarity = T1-T2

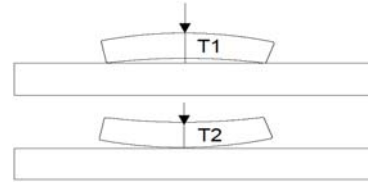

Each terminal extends the full of the product. Hence any coplanarity deviation between terminals is due to curvature in the substrate. TDK guarantees that the edge of each terminal is within 0.05 mm of the horizontal plane.

## 3. Environment (Temperature & Humidity)

### 3-1 Operating & Storage Condition

Storage Temperature Range : -40 ~ +85 °C  
 Operating Temperature Range : -40 ~ +85 °C  
 Humidity : 0 ~ 90 %RH (Max. wet bulb temperature 38 °C )

### 3-2 Storage Condition before Soldering

Temperature : +5 ~ +30 °C  
 Humidity : 20 ~ 70 %RH  
 Term of Storage : Within 12 months (After the delivery) \*  
 Baking : Unnecessary

\* After peeling off cover tape, do not keep exposing the products to the open air.

For the products stored longer than 12 months, confirm their terminals and solderability before use.

### 3-3 Moisture Sensitivity Level

Equal to Level 1

## 4. Electrical Specification

### 4-1 Electrical Characteristics

Parameter	Frequency (MHz)	TDK Spec		
		Min.	Typ.	Max.
Insertion Loss (dB)	1880 to 2025	-	1.05	1.40
Insertion Loss (dB) (-40 to +85 °C)	1880 to 2025	-	-	1.60
VSWR	1880 to 2025	-	1.50	2.0
Attenuation (dB)	2400 to 2500	10	19.0	-
	3760 to 4050	25	46.0	-
	5150 to 5850	25	50.0	-
	5640 to 6075	25	46.0	-
	7520 to 8100	25	33.0	-
	9400 to 10125	22	27.0	-
Characteristic Impedance (ohm)		50 (Nominal)		

Ta = +25+/-5°C

### 4-2 Maximum Ratings

Parameter	TDK Spec		Conditions
	Min.	Max.	
Power Handling (W) <sup>*1</sup>		0.5	
Human Body Model : HBM @Each Port (V)	-1000	1000	100pF / 1500ohm
Machine Model : MM @Each Port (V)	-150	150	200pF / 0ohm
Charged Device Model : CDM @Each Port (V)	-500	500	Relative humidity : 60%RH max

\*1 : Refer to 3GPP TS 38.101-1 V15.2.0

### 5. Typical Electrical Characteristics

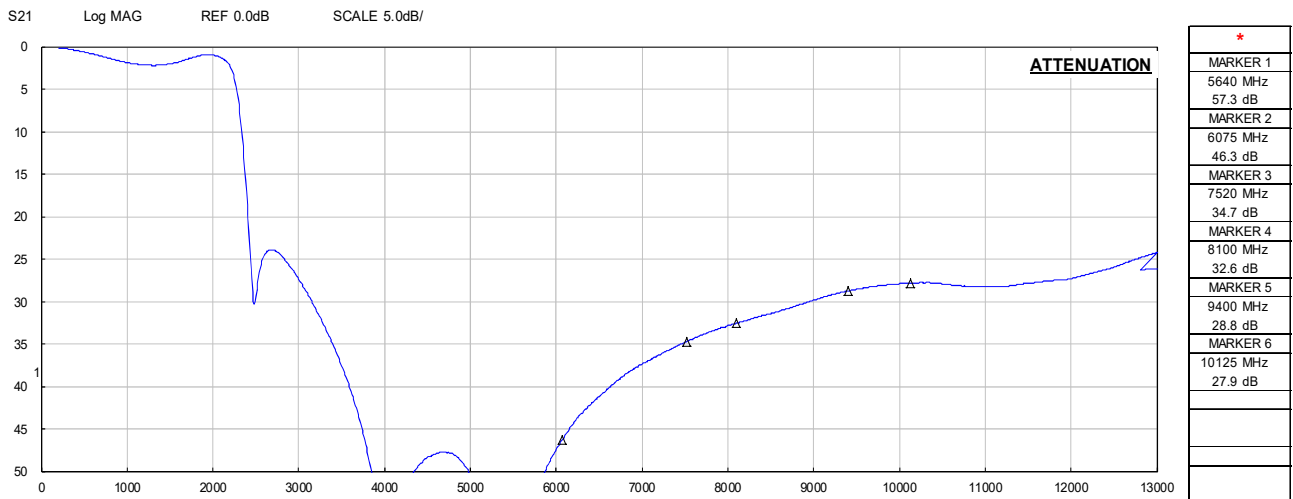
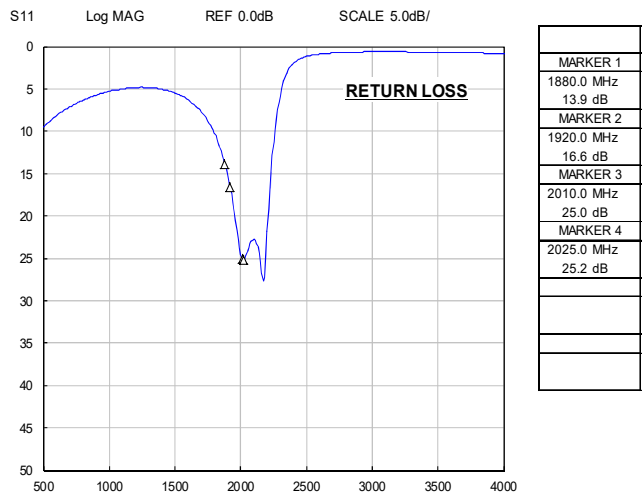
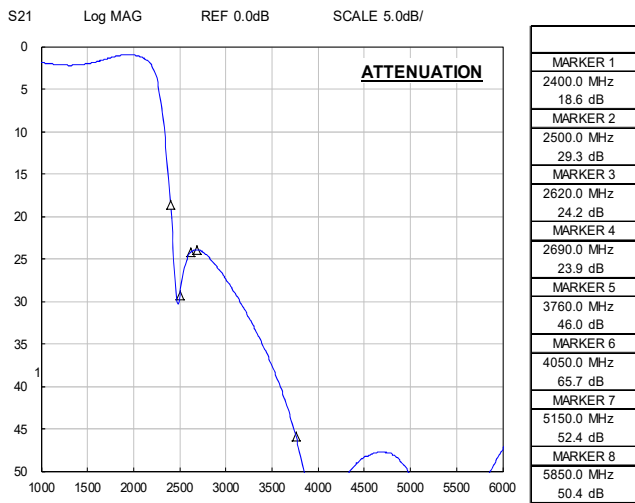
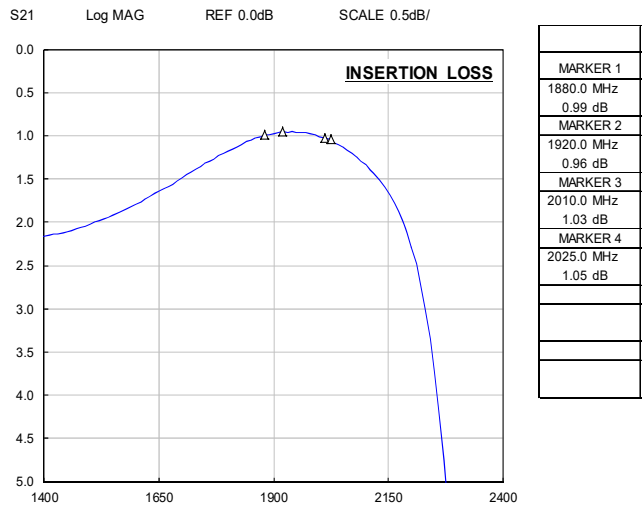
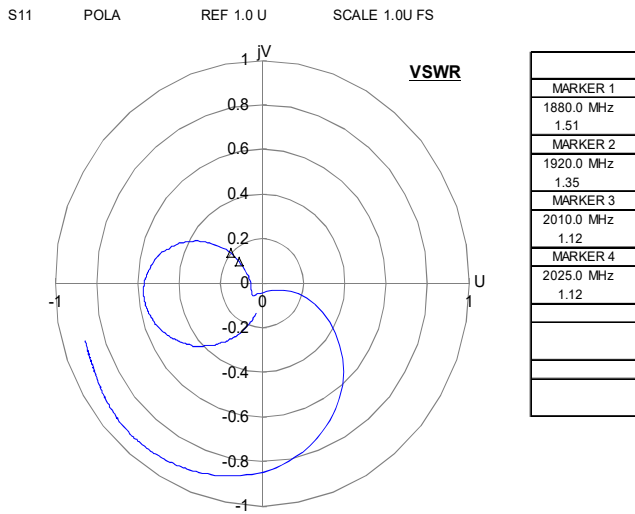

## 6. Test Circuit

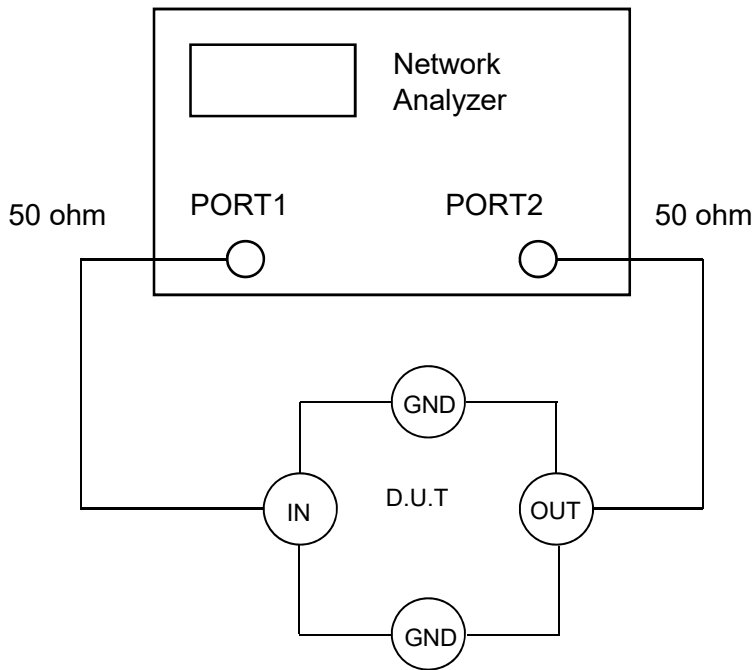

**Note 1:** The Port Extension function on the Network Analyzer is used to extend the calibration plane to the DUT terminals.

**Note 2:** Loss in the PCB traces is compensated for by measurement data taken on a PCB Thru' line.

## 7. Recommended Land Pattern

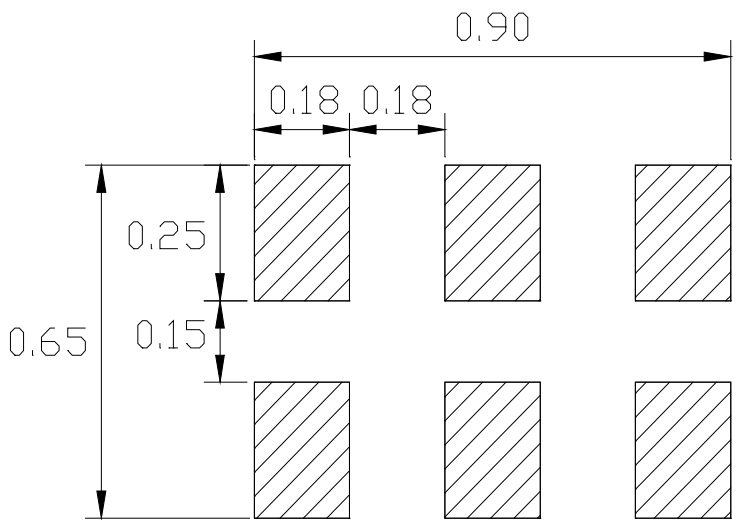

Unit:mm

## 8. Environmental and Quality Proposal

This product satisfies the electrical specification after the following tests.  
(When measured after two hours in normal conditions)

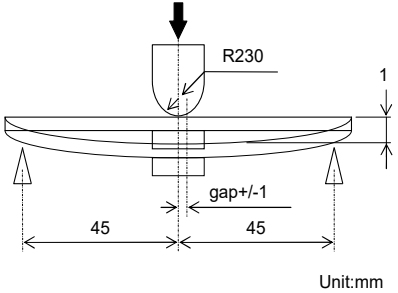
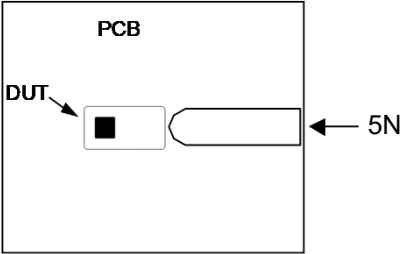
Temperature Characteristics	All data initially taken at +25°C, then repeated at -40°C and again at +85 °C
Heat Proof	+85 +/- 2 °C for 1000 hours
Cold Proof	-40 +/- 2 °C for 500 hours
Moisture Proof	+60 +/- 2 °C, 90~95%RH for 1000 hours
Heat Shock	-40 ~ +85 °C for 350 cycles, each cycle being 30 min
Vibration	10-500Hz vibration frequency (10G Max.) with 1.52mmp-p amplitude for two hours in x,y,z directions
Mechanical Shock	1.Acceleration 1000m/s <sup>2</sup> 2.Direction X, Y, Z ,X',Y',Z',axes 3.Time 6ms duration and 3 times in each direction
Solderability	The dipped surface of the terminal shall be at least 75% covered with solder after dipped in solder bath of 245+/- 3 °C for 3 +/- 0.5 sec. Remark solder: Sn-3.0Ag-0.5Cu Remark flux: Rosin 25%, Alcohol 75%
Solder Heat Shock	It shall be possible to hot air reflow the components three times with a temperature profile shown below.
Drop Shock	Dropped onto steel plate or concrete from 100cm height three times.
Bending	<p>Solder specimen components on the test printed circuit board (L:100 x W:40 x T:0.8mm) in appended recommended PCB pattern. Apply the load in direction of the arrow until bending reaches 1mm for 5+/-1 sec.</p>  <p style="text-align: right;">Unit:mm</p>
Board Adhesion (Push Test)	<p>Solder specimen components on the test printed circuit board (L:100 x W:40 x T:0.8mm) in appended recommended PCB pattern. Apply the load in direction of the arrow until 5N for 5+/-1 sec.</p> 



### 9. Recommended Reflowing Temperature Profile

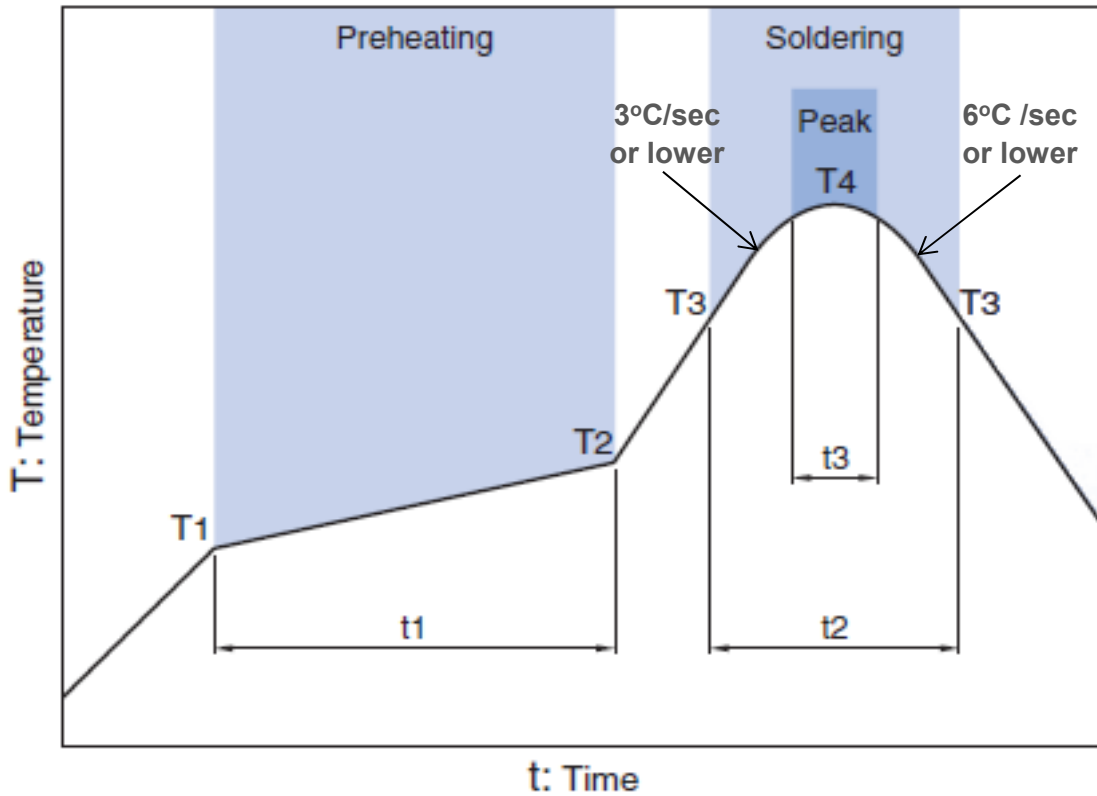

Preheating			Soldering			
Temp.		Time	Critical zone (T3 to T4)		Peak	
T1	T2	t1	T3	t2	T4	t3 *
150°C	200°C	60 to 120sec	217°C	60 to 120sec	240 to 260°C	30 sec Max

\* t3 : Time within 5°C of actual peak temperature.

The maximum number of reflow is 3.

Note: Lead free solder is recommended.

Recommended solder is Sn-3.0Ag-0.5Cu. (M705 by Senju Metal Industry)

## 10. Packing

### 10-1 Carrier Tape

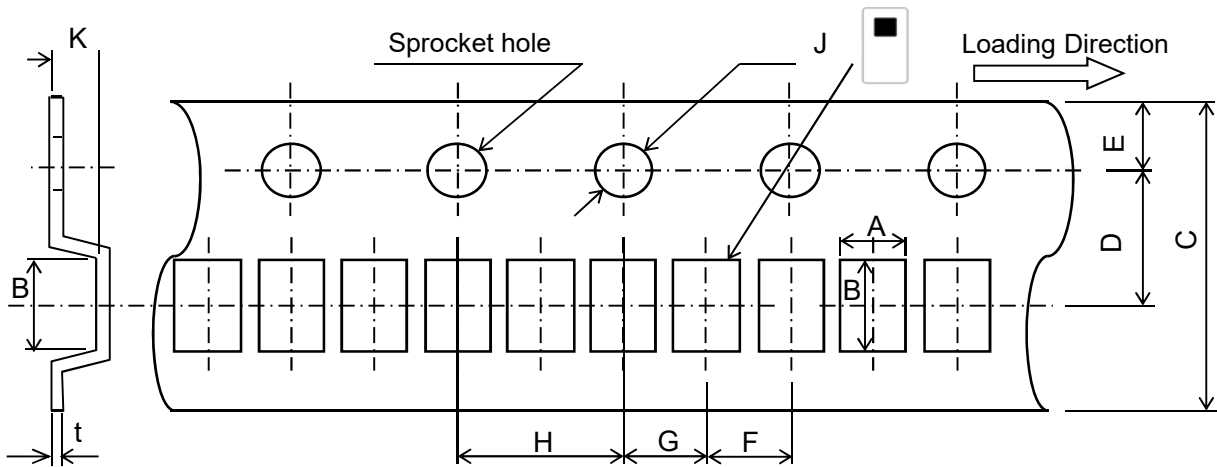

(Unit:mm)

A	B	C	D	E	F	G	H	J	K	t
0.62	1.12	8.0	3.5	1.75	2.0	2.0	4.0	1.5	0.48	0.20
+/-0.05	+/-0.05	+/-0.2	+/-0.05	+/-0.1	+/-0.05	+/-0.05	+/-0.05	+0.1/-0	Max	+/-0.05

### 10-2 Reel Dimensions

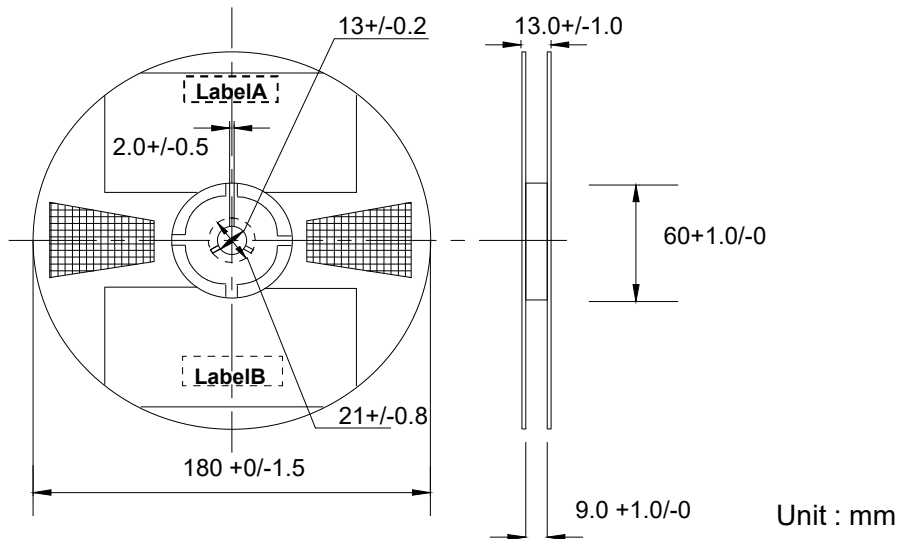

Unit : mm

### 10-3 Standard Reel Packaging Quantities

10000pcs./reel

## **11. Other**

### **11-1 Caution**

The products listed on this specification sheet are intended for use in general electronic equipment (AV equipment, telecommunications equipment, home appliances, amusement equipment, computer equipment, personal equipment, office equipment, measurement equipment, industrial robots) under a normal operation and use condition.

The products are not designed or warranted to meet the requirements of the applications listed below, whose performance and/or quality require a more stringent level of safety or reliability, or whose failure, malfunction or trouble could cause serious damage to society, person or property. Please understand that we are not responsible for any damage or liability caused by use of the products in any of the applications below or for any other use exceeding the range or conditions set forth in this specification sheet.

- Aerospace/Aviation equipment
- Transportation equipment (cars, electric trains, ships, etc.)
- Medical equipment
- Power-generation control equipment
- Atomic energy-related equipment
- Seabed equipment
- Transportation control equipment
- Public information-processing equipment
- Military equipment
- Electric heating apparatus, burning equipment
- Disaster prevention/crime prevention equipment
- Safety equipment
- Other applications that are not considered general-purpose applications

When designing your equipment even for general-purpose applications, you are kindly requested to take into consideration securing protection circuit/device or providing backup circuits in your equipment.

### **11-2 Storage Conditions**

Do not store the product in following conditions, performance may deteriorate.

- Exposure to atmosphere containing corrosive gas, such as Cl<sub>2</sub>, NH<sub>3</sub>, SO<sub>x</sub> and NO<sub>x</sub>
- Exposure to volatile or combustible gases
- Exposure to excessive dust
- Exposure to direct sunlight
- Exposure to direct water splashing
- Exposure to freezing temperature
- Exposure to dew condensation due to high humidity

### **11-3 Product Origin**

1. TDK Akita Corporation, Akita, Japan
2. TDK Dalian Corporation, Dalian, China

## X-ON Electronics

Largest Supplier of Electrical and Electronic Components

*Click to view similar products for [tdk manufacturer](#):*

Other Similar products are found below :

[VLF5012ST-1R0N2R5](#) [R14493](#) [SWS1000L-24/BL](#) [CXA-2115](#) [MCZ1210AH301L2T](#) [78P7200-IH/F](#) [MLP2012S1R5TT](#) [ACH3218-682-TD01](#) [ACT45B-KIT](#) [NL565050T-822J-PF](#) [C1005JB1H471K050BA](#) [C1608CH1H151J080AA](#) [C2012JB1H105K125AB](#)  
[C4532NP01H154J250KA](#) [CD75-B2GA331KYGKA](#) [CLF10040T-221M](#) [CLF12555T-220M](#) [R22095\\*REPAIRED](#) [MLF1005LR12K](#)  
[VLS252015T-3R3M1R0](#) [VLS4012T-150MR65](#) [ZCAT-KIT](#) [MPZ2012-KIT](#) [NLV32T-R27J-EFD](#) [CGA3EANP02A682J080AC](#)  
[CKCM25C0G2A101K060AK](#) [CLF10040T-4R7N](#) [WTM505090-10K2-5V-G1](#) [VLS252010HBX-R24M-1](#) [CGJ2B2X7R1C222K](#)  
[CGA9M1X7T2J334K](#) [CGA8P3X7T2E105M/SOFT](#) [CGA6J4C0G2J392J](#) [CGA6M3X7R2E154K](#) [CGA3E3C0G2E181J](#) [CGA2B2C0G1H331J](#)  
[C-WPTX01-E6-KIT](#) [CEU-AC01-E6-KIT](#) [CERB3UX5R0G105M](#) [RLF12545T-100M5R1-PF](#) [PFE500F28/T](#) [CCT406393-600-36-02](#)  
[PFC3819QM-181K09B-00](#) [VLF3010AT-100MR49](#) [MMZ0603D330C](#) [MPZ2012S102ATD25](#) [MLG0603P-2-KIT](#) [MLG1608B18NJ](#) [UHV-251A](#) [FHV-11AN](#)