

1608 TYPE MULTILAYER DIPLEXER

P/N: **DPX162690DT-8058A1**

MECHANICAL DIMENSIONS

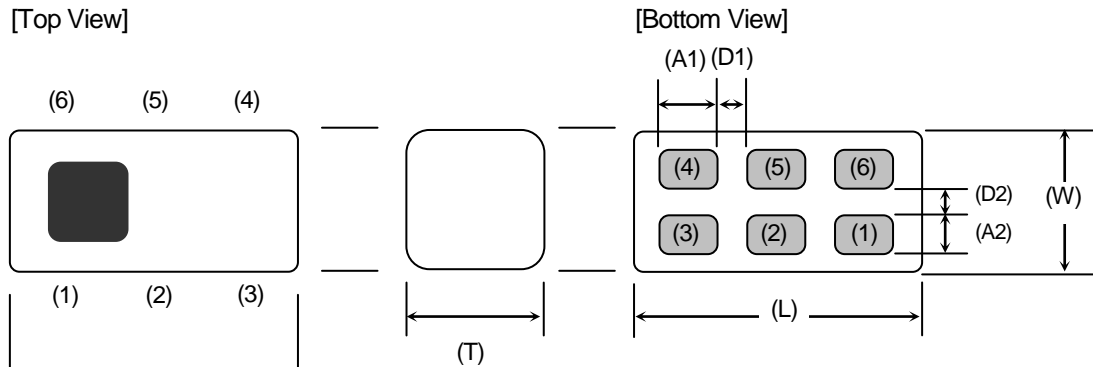

[Side View]



PIN Configuration

(1)	(2)	(3)	(4)	(5)	(6)
GND	Common	GND	High-Band	GND	Low-Band

Dimension (mm)

(L)	(W)	(T)	(A1)	(D1)	(A2)	(D2)
1.60 +/-0.10	0.80 +/-0.15	0.80 max.	0.35 +/-0.05	0.22 +/-0.05	0.225 +/-0.05	0.22 +/-0.05

TEMPERATURE RANGE

Storage Temperature	-40 ~ +85 °C
Operating Temperature	-40 ~ +85 °C

ELECTRICAL CHARACTERISTICS (Ta= +25 ± 5 °C)

Low-Band

Parameter	Freq. (MHz)	Specification	typical value	Unit
Insertion Loss at 25degC	704 -960	0.73 max.	0.58	dB
Insertion Loss at -40degC to +85degC	704 -960	0.83 max.	0.65	dB
Attenuation at -40degC to +85degC	1570-2690	25 min.	28	dB
Return Loss	704 -960	12 min.	19	dB

High-Band

Parameter	Freq. (MHz)	Specification	typical value	Unit
Insertion Loss at 25degC	1570-2690	0.70 max.	0.47	dB
Insertion Loss at -40degC to +85degC	1570-2690	0.78 max.	0.52	dB
Attenuation at -40degC to +85degC	704 -814	20 min.	23	dB
	814 -905	23 min.	25	dB
	905 -960	20 min.	24	dB
	5150 -5850	12 min.	15	dB
Return Loss	1570-2690	12 min.	16	dB

Common

Parameter	Freq. (MHz)	Specification	typical value	Unit
Isolation (Low-High) at -40degC to +85degC	704 -814	20 min.	23	dB
	814 -905	23 min.	26	dB
	905 -960	20 min.	29	dB
	1570-2690	25 min.	29	dB
Return Loss	704 -960	12 min.	19	dB
	1570-2690	12 min.	17	dB

We recommend to terminate for all port with 50ohm at all times.

RECOMMENDED LAND PATTERN

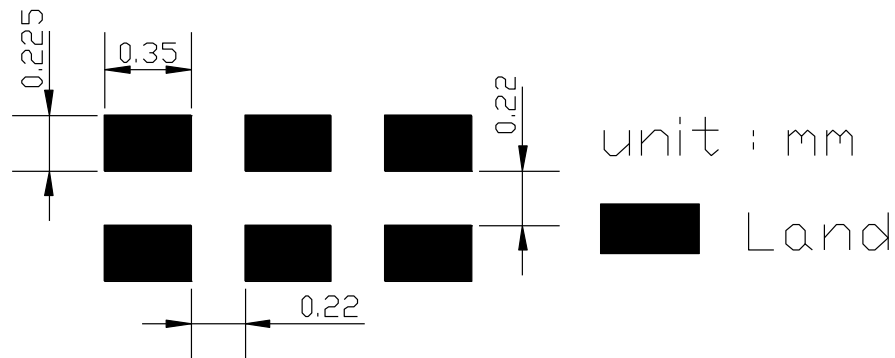

FREQUENCY CHARACTERISTICS (Sample Data)

Low-Band Port

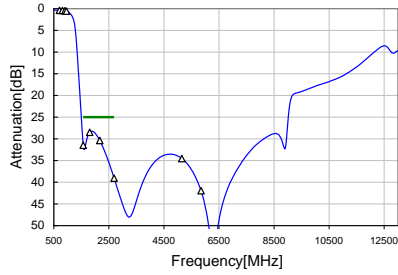

Insertion Loss	
704 MHz	0.39 dB
814 MHz	0.43 dB
905 MHz	0.49 dB
960 MHz	0.58 dB

Attenuation	
1570 MHz	31.48 dB
1805 MHz	28.49 dB
2170 MHz	30.39 dB
2690 MHz	39.06 dB
5150 MHz	34.55 dB
5850 MHz	41.95 dB

High-Band Port

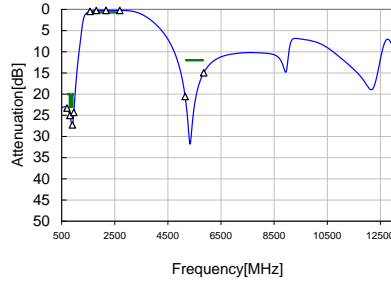

Insertion Loss	
1570 MHz	0.47 dB
1805 MHz	0.26 dB
2170 MHz	0.26 dB
2690 MHz	0.25 dB

Attenuation	
704 MHz	23.29 dB
814 MHz	25.03 dB
905 MHz	27.27 dB
960 MHz	24.32 dB
5150 MHz	20.56 dB
5850 MHz	14.96 dB

Low-Band Port

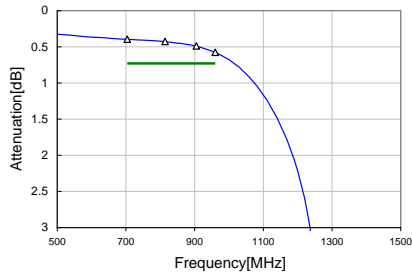

Insertion Loss	
704 MHz	0.39 dB
814 MHz	0.43 dB
905 MHz	0.49 dB
960 MHz	0.58 dB

High-Band Port

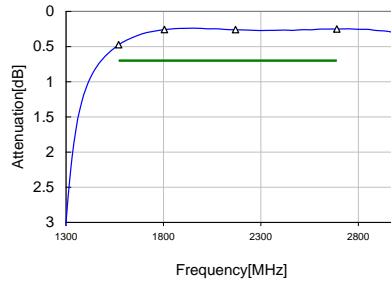

Insertion Loss	
1570 MHz	0.47 dB
1805 MHz	0.26 dB
2170 MHz	0.26 dB
2690 MHz	0.25 dB

Common Port Return Loss

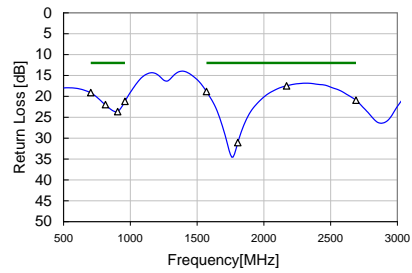

704 MHz	19.10 dB
814 MHz	21.97 dB
905 MHz	23.67 dB
960 MHz	21.20 dB

1570 MHz	18.85 dB
1805 MHz	31.07 dB
2170 MHz	17.49 dB
2690 MHz	20.93 dB

Isolation

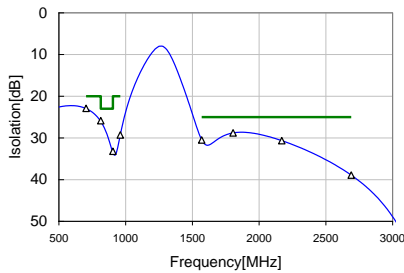

704 MHz	22.9 dB
814 MHz	25.9 dB
905 MHz	33.2 dB
960 MHz	29.3 dB

1570 MHz	30.5 dB
1805 MHz	28.8 dB
2170 MHz	30.6 dB
2690 MHz	38.9 dB

Low-Band Port Return Loss

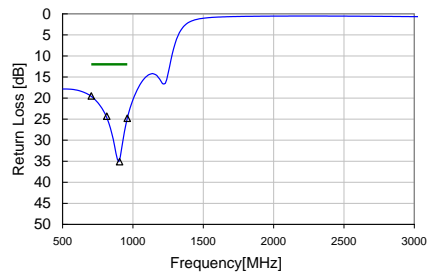

704 MHz	19.50 dB
814 MHz	24.32 dB
905 MHz	35.12 dB
960 MHz	24.81 dB

High-Port Return Loss

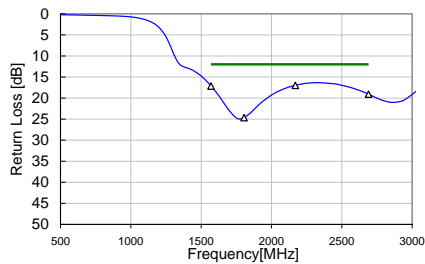

1570 MHz	17.14 dB
1805 MHz	24.65 dB
2170 MHz	16.99 dB
2690 MHz	19.08 dB

ENVIRONMENT INFORMATION

RoHS STATEMENT

ROHS Compliance

Recommended reflowing temperature profile

Pb free solder

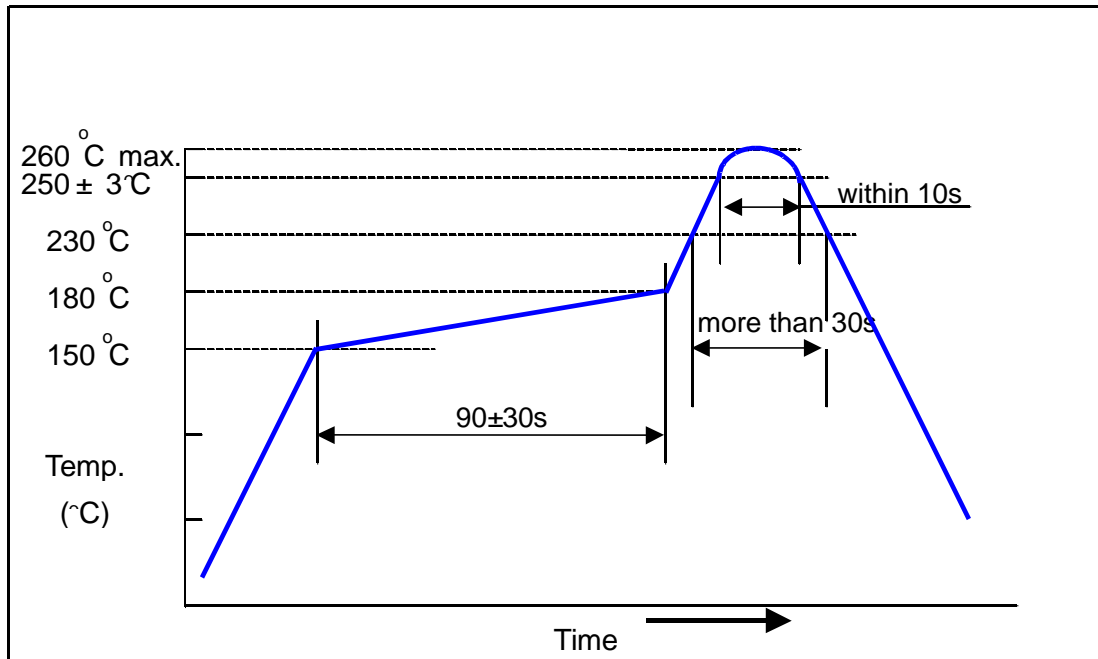

Note: All specifications are subject to change and are not guaranteed.

Packing

1. Carrier Tape

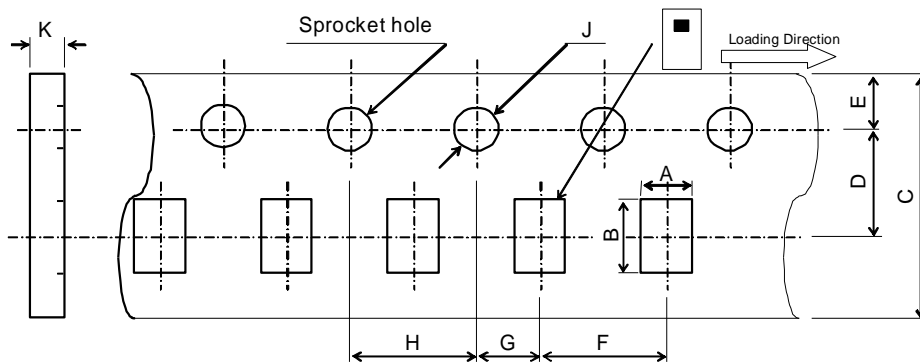

A	B	C	D	E	F
0.97±0.05	1.8±0.05	8.0±0.2	3.5±0.05	1.75±0.1	4.0±0.1
G	H	J	K		
2.0±0.05	4.0±0.1	1.5+0.1/0	0.95±0.05		

2. Reel Dimensions

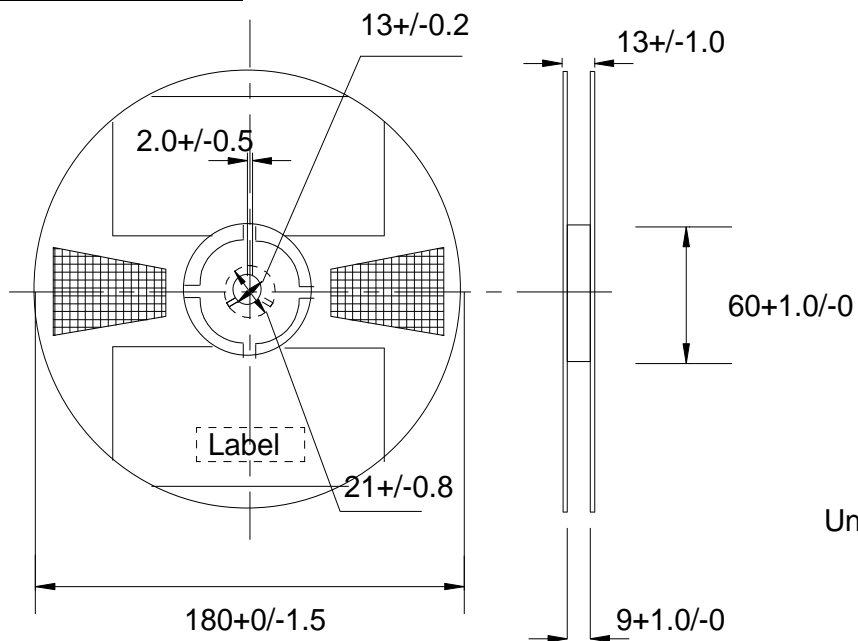

Unit: mm

3. Standard packaging quantities

4000pcs./reel

X-ON Electronics

Largest Supplier of Electrical and Electronic Components

Click to view similar products for [tdk manufacturer](#):

Other Similar products are found below :

[VLF5012ST-1R0N2R5](#) [R14493](#) [SWS1000L-24/BL](#) [CXA-2115](#) [MCZ1210AH301L2T](#) [78P7200-IH/F](#) [MLP2012S1R5TT](#) [ACH3218-682-TD01](#) [ACT45B-KIT](#) [NL565050T-822J-PF](#) [C1005JB1H471K050BA](#) [C1608CH1H151J080AA](#) [C2012JB1H105K125AB](#)
[C4532NP01H154J250KA](#) [CD75-B2GA331KYGKA](#) [CLF10040T-221M](#) [CLF12555T-220M](#) [R22095*REPAIRED](#) [MLF1005LR12K](#)
[VLS252015T-3R3M1R0](#) [VLS4012T-150MR65](#) [ZCAT-KIT](#) [MPZ2012-KIT](#) [NLV32T-R27J-EFD](#) [CGA3EANP02A682J080AC](#)
[CKCM25C0G2A101K060AK](#) [CLF10040T-4R7N](#) [WTM505090-10K2-5V-G1](#) [VLS252010HBX-R24M-1](#) [CGJ2B2X7R1C222K](#)
[CGA9M1X7T2J334K](#) [CGA8P3X7T2E105M/SOFT](#) [CGA6J4C0G2J392J](#) [CGA6M3X7R2E154K](#) [CGA3E3C0G2E181J](#) [CGA2B2C0G1H331J](#)
[C-WPTX01-E6-KIT](#) [CEU-AC01-E6-KIT](#) [CERB3UX5R0G105M](#) [RLF12545T-100M5R1-PF](#) [PFE500F28/T](#) [CCT406393-600-36-02](#)
[PFC3819QM-181K09B-00](#) [VLF3010AT-100MR49](#) [MMZ0603D330C](#) [MPZ2012S102ATD25](#) [MLG0603P-2-KIT](#) [MLG1608B18NJ](#) [UHV-251A](#) [FHV-11AN](#)