

SPECIFICATION

SPEC NO. TFA9NAA00664

DATE : May 31st, 2018

To

XIANGGAO

CUSTOMER'S PRODUCT NAME

DPX202690DT-4075J1

TDK'S PRODUCT NAME

DPX202690DT-4075J1

RECEIPT CONFIRMATION

DATE : YEAR MONTH DAY

TDK Corporation

Sales

Electronic Components Sales &
Marketing Group

Engineering

Electronic Components Business Company
Communication Devices Business Group

APPROVED	PERSON IN CHARGE

APPROVED	CHECKED	PERSON IN CHARGE
<i>N. Harada</i>	<i>K. Tsukamoto</i>	<i>H. Ashida</i>

Diplexer Specification
 (TDK Part Number : DPX202690DT-4075J1)

1. Marking

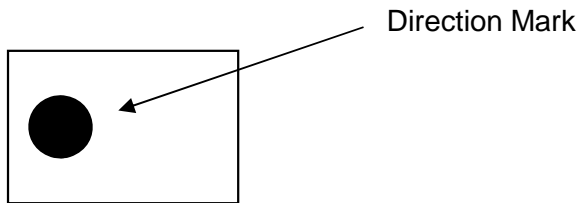

2. Mechanical Outline

2-1 Package

Package: Surface mount package
 Delivery Medium: Tape on reel
 Soldering Method: IR-reflow
 Size: 2.00 x 1.25mm typ.
 Height: 0.70 mm typ.

Mechanical Dimensions

[Top View]

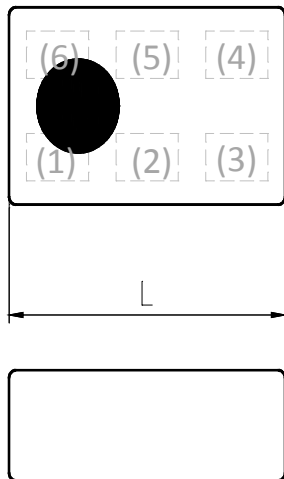

[Bottom View]

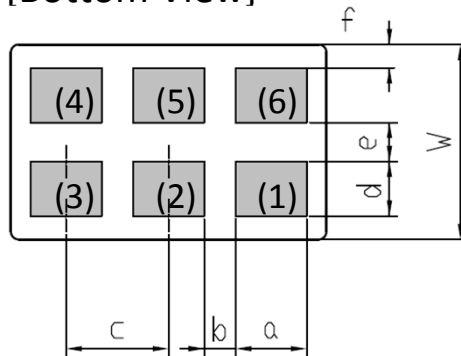

Dimensions (mm)

L	W	T	a	b	c	d	e	f
2.00	1.25	0.70	0.40	0.25	0.65	0.35	0.30	0.125
+/-0.10	+/-0.10	+/-0.10	+/-0.10	+/-0.10	+/-0.10	+/-0.10	+/-0.10	+/-0.05

Terminal functions

(1)	GND
(2)	Common Port
(3)	GND

(4)	High-Band Port
(5)	GND
(6)	Low-Band Port

2-2 Coplanarity

0.05 mm max. difference in Z-direction as follows

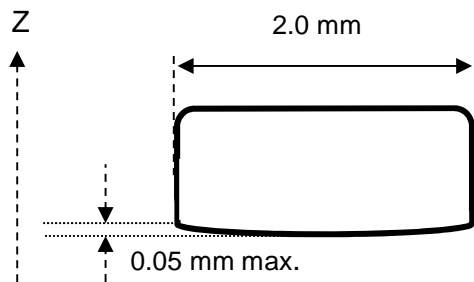

Coplanarity measurement method

Coplanarity = T1-T2

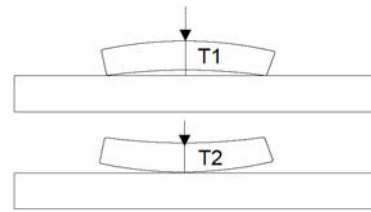

Each terminal extends the full of the product. Hence any coplanarity deviation between terminals is due to curvature in the substrate. TDK guarantees that the edge of each terminal is within 0.05 mm of the horizontal plane.

3. Environment (Temperature & Humidity)

3-1 Operating & Storage Condition

Storage Temperature Range : -40 ~ +85 °C

Operating Temperature Range : -40 ~ +85 °C

Humidity : 0 ~ 90 % R.H. (Max. wet bulb temperature 38 °C)

3-2 Storage Condition before Soldering

Temperature : +5 ~ +30 °C

Humidity : 20 ~ 70 % RH

Term of Storage : Within 12 months (After the delivery) *

: Within 1 month (After peeling off top tape)

Baking : Unnecessary

* For the products stored longer than 12 months, confirm their terminals and solderability before they are used.

3-3 Moisture Sensitivity Level

Equal to Level 1

4. Electrical Specification

4-1 Electrical Characteristics

Low-Band

Parameter	Frequency (MHz)	Specification		
		Min.	Typ.	Max.
Insertion Loss (dB)	699 to 960	-	0.40	0.45
Insertion Loss (dB) (-40 to +85 °C)	699 to 960	-		0.50
	to	-		
Return Loss (dB)	699 to 960	20	25.2	-
Attenuation (dB)	1559 to 1606	10	19.0	-
	1648 to 1698	15	27.7	-
	1710 to 2200	25	30.9	-
	2400 to 2690	30	39.3	-
	5150 to 5850	20	25.4	-
Characteristic Impedance (ohm)		50 (Nominal)		

Ta = +25+/-5°C

High-Band

Parameter	Frequency (MHz)	Specification		
		Min.	Typ.	Max.
Insertion Loss (dB)	1710 to 1785	-	0.42	0.52
	1805 to 2200	-	0.37	0.47
	2300 to 2690	-	0.38	0.48
Insertion Loss (dB) (-40 to +85 °C)	1710 to 1785	-		0.62
	1805 to 2200	-		0.57
	2300 to 2690	-		0.58
Return Loss (dB)	1710 to 2690	15	18.7	-
Attenuation (dB)	699 to 915	29	30.6	-
	915 to 960	25	26.9	-
	5150 to 5850	24	27.9	-
Characteristic Impedance (ohm)		50 (Nominal)		

Ta = +25+/-5°C

Common

Parameter	Frequency (MHz)	Specification		
		Min.	Typ.	Max.
Isolation (dB)	699 to 915	30	31.5	-
	915 to 960	25	27.6	-
	1710 to 2690	30	32.0	-
Return Loss (dB)	699 to 960	20	24.1	-
	1710 to 2690	15	19.1	-
Characteristic Impedance (ohm)		50 (Nominal)		

Ta = +25+/-5°C

4-2 Maximum Ratings

Parameter	TDK Spec		Conditions
	Min.	Max.	
Human Body Model : HBM @Each Port (V)	-1000	1000	100pF / 1500ohm
Machine Model : MM @Each Port (V)	-150	150	200pF / 0ohm
Charged Device Model : CDM @Each Port (V)	-500	500	Relative humidity : 51%RH max

Ambient temperature : +25+/-5°C

5. Typical Electrical Characteristics

Insertion Loss (Low-Band)

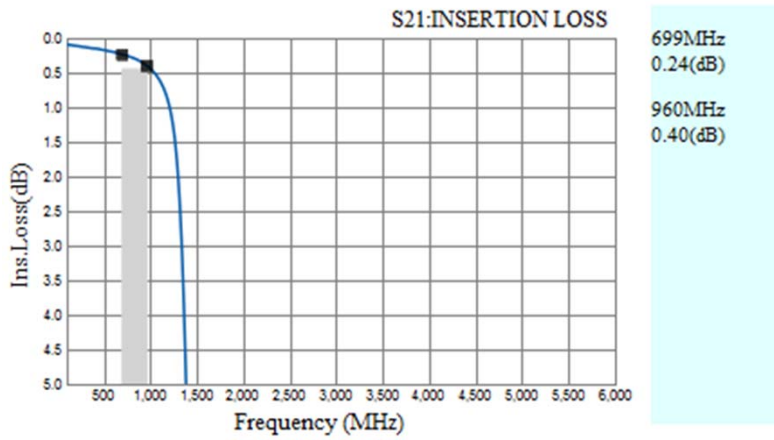

Attenuation (Low-Band)

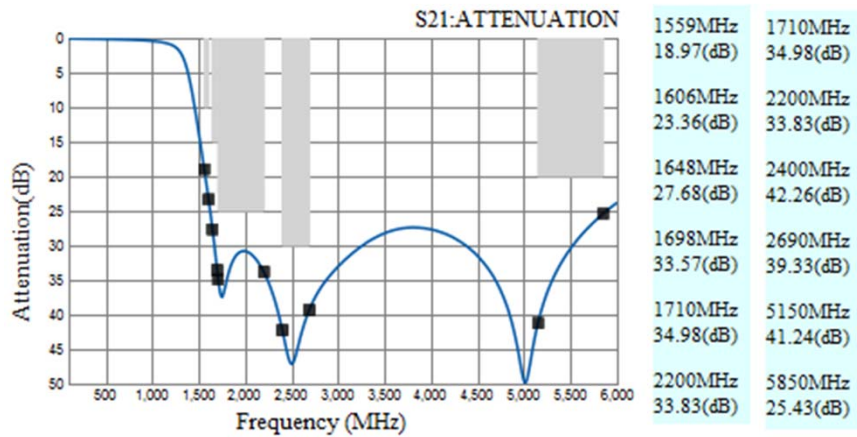

Insertion Loss (High-Band)

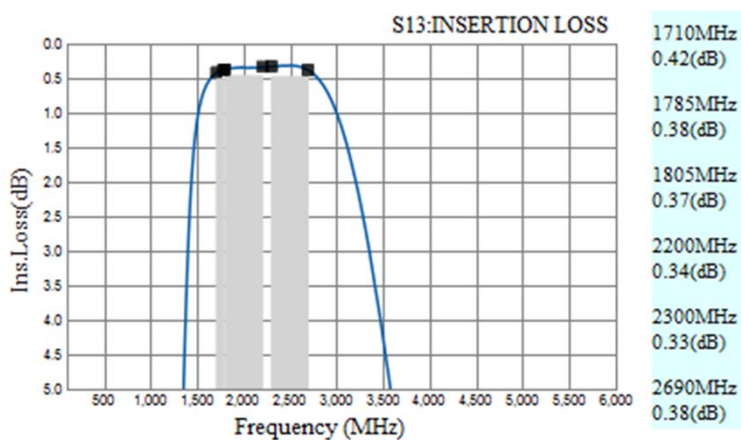

Attenuation (High-Band)

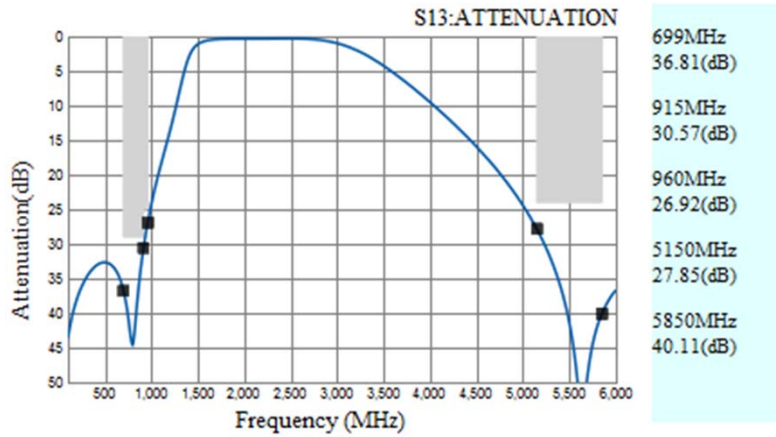

Common port Return Loss

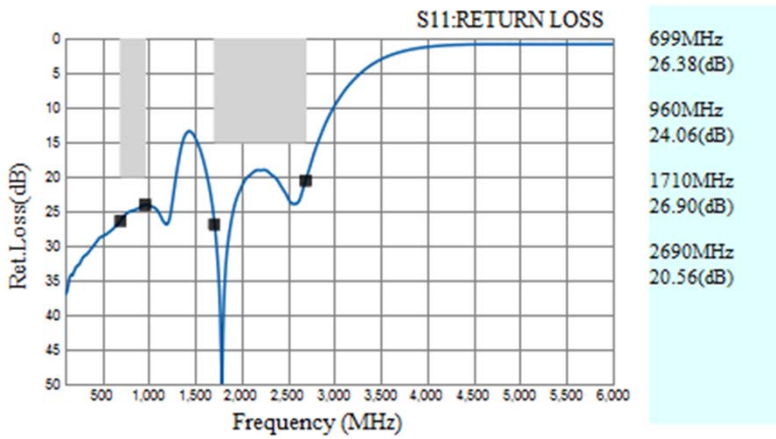

Isolation

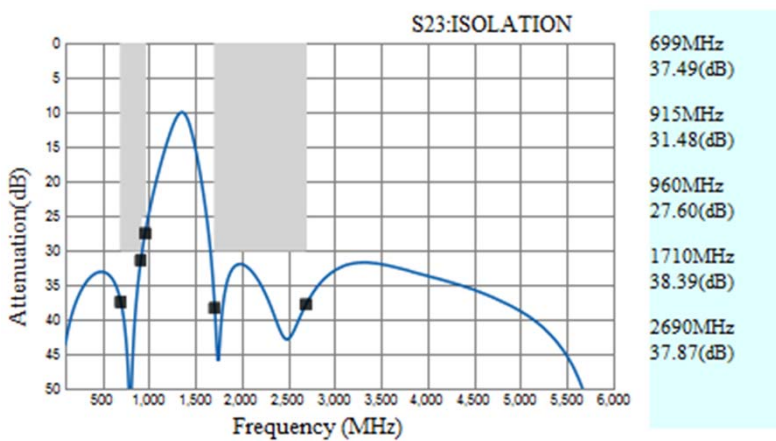

6. Test Circuit

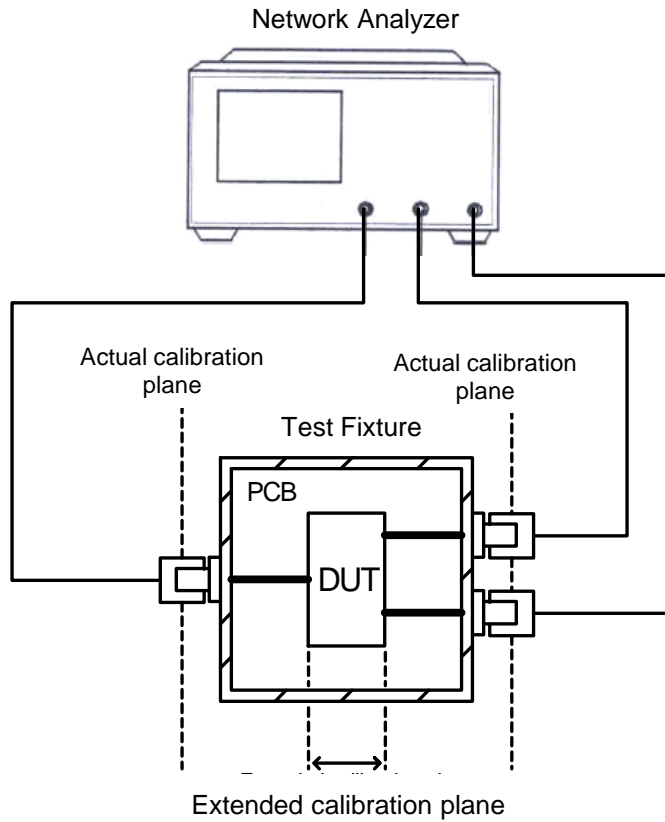

Note 1:

The Port Extension function on the Network Analyzer is used to extend the calibration plane to the DUT terminals.

Note 2:

Loss in the PCB traces is compensated for by measurement data taken on a PCB Thru' line.

7. Recommended Land Pattern

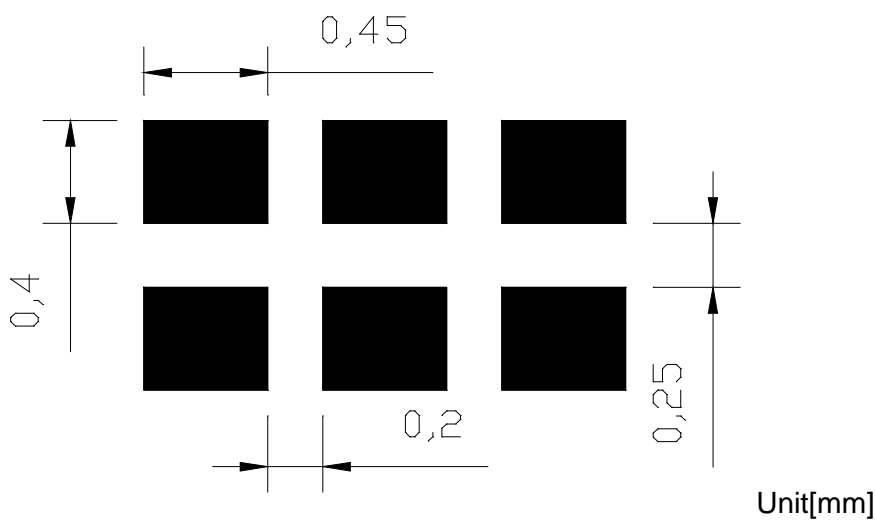

8. Environmental and Quality Proposal

This product satisfies the electrical specification after the following tests.
 (When measured after two hours in normal conditions)

Temperature Characteristics	All data initially taken at +25°C, then repeated at -40°C and again at +85°C.	
Heat Proof	+85+/-2 °C for 1000 hours	
Cold Proof	-40+/-2 °C for 500 hours	
Moisture Proof	+60+/-2 °C, 90~95% R.H. for 1000 hours	
Heat Shock	-40 ~ +85 °C for 350 cycles each cycle being 30 min	
Vibration	10-500Hz vibration frequency (10G Max.) with 1.52mmp-p amplitude for two hours in x,y,z directions	
Mechanical Shock	1.Acceleration 1000m/s ² 2.Direction X, Y, Z ,X',Y',Z',axes 3.Time 6ms duration and 3 times in each direction	
Solderability	The dipped surface of the terminal shall be at least 75% covered with solder after dipped in solder bath of 245+/-3 °C for 3+/-0.5 sec. Remark solder: Sn-3.0Ag-0.5Cu Remark flux: Rosin 25%, Alcohol 75%	
Solder Heat Shock	It shall be possible to hot air reflow the components three times with a temperature profile shown below.	
Drop Shock	Dropped onto steel plate or concrete from 100cm height three times.	
Bending Test	<p>Solder specimen components on the test printed circuit board(L:100 x w:40 x t:0.8mm) in appended recommended PCB pattern. Apply the load in direction of the arrow until bending reaches 1mm for 5+/-1 sec.</p>	<p style="text-align: right;">Unit:mm</p>
Board Adhesion (Push Test)	<p>Solder specimen components on the test printed circuit board(L:100 x w:40 x t:0.8mm) in appended recommended PCB pattern. Apply the load in direction of the arrow until 5N for 5+/-1 sec.</p>	

9. Recommended Reflowing Temperature Profile

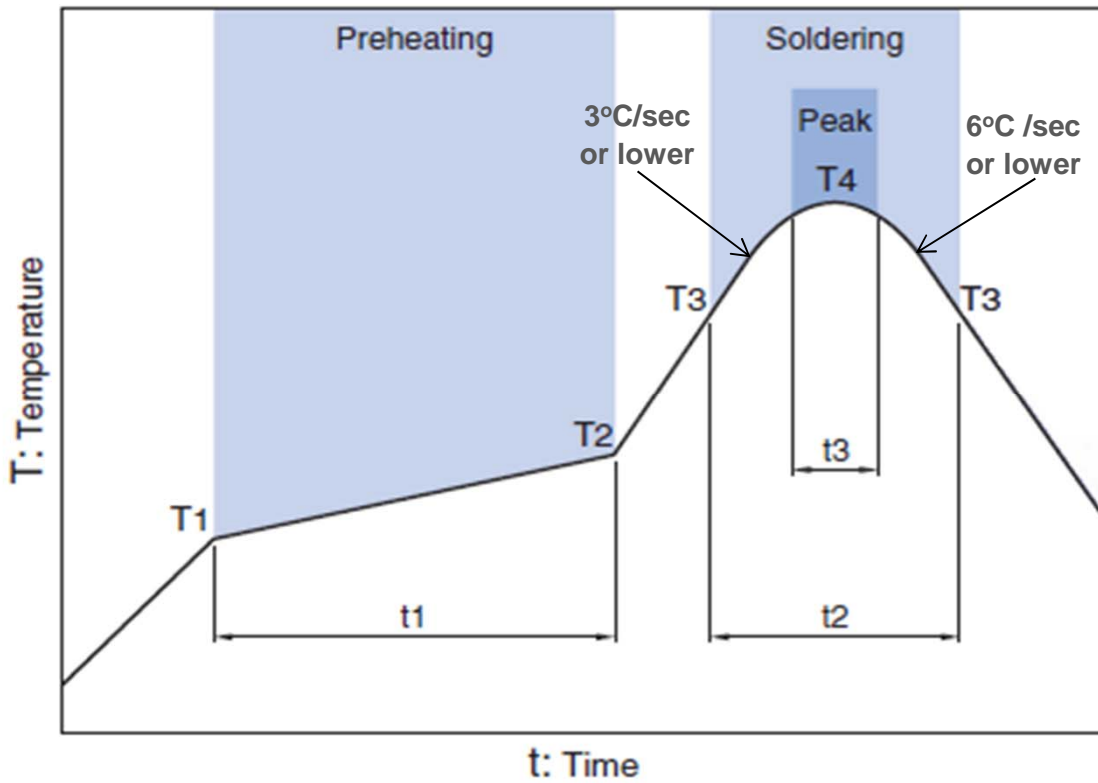

Preheating			Soldering			
			Critical zone (T3 to T4)		Peak	
Temp.		Time	Temp.	Time	Temp.	Time
T1	T2	t1	T3	t2	T4	t3 *
150°C	200°C	60 to 120sec	217°C	60 to 120sec	240 to 260°C	30 sec Max

* t3 : Time within 5°C of actual peak temperature.

The maximum number of reflow is 3.

Note: Lead free solder is recommended.

Recommended solder is Sn-3.0Ag-0.5Cu. (M705 by Senju Metal Industry)

10. Packing

10-1 Carrier Tape

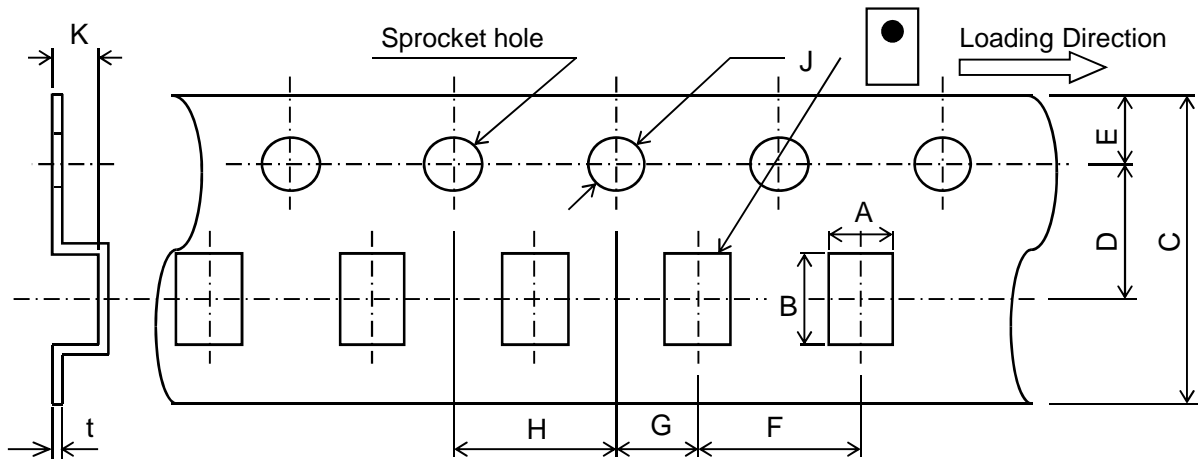

(Unit:mm)

A	B	C	D	E	F	G	H	J	K	t
1.45	2.25	8.0	3.5	1.75	4.0	2.0	4.0	1.55	1.05	0.25
+/-0.1	+/-0.1	+/-0.2	+/-0.05	+/-0.1	+/-0.1	+/-0.05	+/-0.1	+/-0.05	Max	+/-0.05

10-2. Reel Dimensions

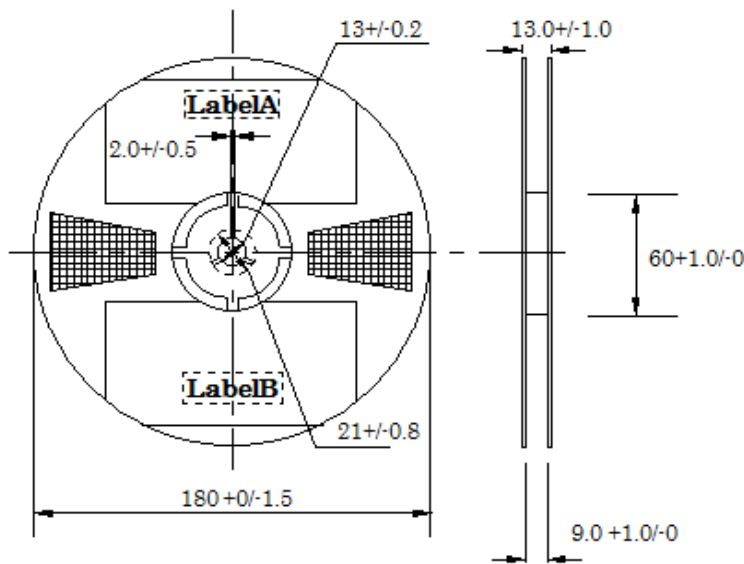

Unit : mm

10-3. Standard Reel Packaging Quantities

2000pcs./reel

11. Other

11-1 Notice

The products listed on this specification sheet are intended for use in general electronic equipment (AV equipment, telecommunications equipment, home appliances, amusement equipment, computer equipment, personal equipment, office equipment, measurement equipment, industrial robots) under a normal operation and use condition.

The products are not designed or warranted to meet the requirements of the applications listed below, whose performance and/or quality require a more stringent level of safety or reliability, or whose failure, malfunction or trouble could cause serious damage to society, person or property. Please understand that we are not responsible for any damage or liability caused by use of the products in any of the applications below or for any other use exceeding the range or conditions set forth in this specification sheet.

- Aerospace/Aviation equipment
- Transportation equipment (cars, electric trains, ships, etc.)
- Medical equipment
- Power-generation control equipment
- Atomic energy-related equipment
- Seabed equipment
- Transportation control equipment
- Public information-processing equipment
- Military equipment
- Electric heating apparatus, burning equipment
- Disaster prevention/crime prevention equipment
- Safety equipment
- Other applications that are not considered general-purpose applications

When designing your equipment even for general-purpose applications, you are kindly requested to take into consideration securing protection circuit/device or providing backup circuits in your equipment.

11-2 Product Origin

1. TDK Akita Corporation, Akita, Japan
2. TDK Dalian Corporation, Dalian, China

X-ON Electronics

Largest Supplier of Electrical and Electronic Components

Click to view similar products for [Signal Conditioning category](#):

Click to view products by [TDK manufacturer](#):

Other Similar products are found below :

[MAPDCC0004](#) [PD0409J5050S2HF](#) [880157](#) [HHS-109-PIN](#) [DC1417J5005AHF](#) [DC4859J5005AHF](#) [AFS14A30-2185.00-T3](#) [AFS14A35-1591.50-T3](#) [DS-323-PIN](#) [DSS-313-PIN](#) [B39321R801H210](#) [B39321R821H210](#) [B39921B4317P810](#) [1A0220-3](#) [2089-6207-00](#) [JP510S](#) [LFB212G45SG8C341](#) [LFB322G45SN1A504](#) [LFL182G45TC3B746](#) [SF2159E](#) [30057](#) [1P510S](#) [CER0813B](#) [3A325](#) [40287](#) [41180](#) [ATB3225-75032NCT](#) [B69842N5807A150](#) [BD0810N50100AHF](#) [BD2326L50200AHF](#) [BD2425J50200AHF](#) [HMC189AMS8TR](#) [C5060J5003AHF](#) [JHS-114-PIN](#) [JP503AS](#) [DC0710J5005AHF](#) [DC2327J5005AHF](#) [DC3338J5005AHF](#) [43020](#) [LFB2H2G60BB1C106](#) [LFL15869MTC1B787](#) [X3C19F1-20S](#) [XC3500P-20S](#) [10013-20](#) [SF2081E](#) [SF2194E](#) [SF2238E](#) [CDBLB455KCAX39-B0](#) [RF1353C](#) [PD0922J5050D2HF](#)